

ecoSwitch™

Advanced Load Management

Controlled Load Switch with Low R_{ON}

NCP45750

The NCP45750 load management device provides a component and area-reducing solution for efficient power domain switching with inrush current limit via soft start. These devices are designed to integrate control and driver functionality with a high performance very low on-resistance power MOSFET in a single package offering safeguards and monitoring via fault protection and power-good signaling. This cost effective solution is ideal for power management and disconnect functions in USB Type-C ports and power management applications requiring low power consumption in a small footprint.

Features

- Advanced Controller with Charge Pump
- Integrated N-Channel MOSFET with Very-Low R_{ON}
- Soft-Start via Controlled Slew Rate
- Adjustable Slew Rate Control
- Fault Detection with Power Good Output
- Thermal Shutdown and Under Voltage Lockout
- Short-Circuit and Adjustable Over-Current Protections
- Input Voltage Range 3 V to 24 V
- Extremely Low Standby Current
- This is a RoHS/REACH Compliant Device

Typical Applications

- USB Type C Power Delivery
- Servers, Set-Top Boxes and Gateways
- Notebook and Tablet Computers
- Telecom, Networking
- Medical and Industrial Equipment
- Hot-Swap Devices and Peripheral Ports

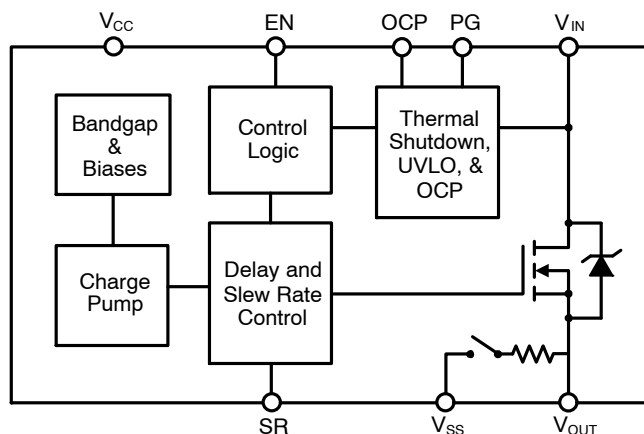

Figure 1. Block Diagram



ON Semiconductor®

www.onsemi.com

| R _{ON} TYP | V _{IN} | DC I _{MAX} * |
|---------------------|-----------------|-----------------------|
| 5.9 mΩ | 3 V to 24 V | 10 A |

*I_{MAX} is defined as the maximum steady state current the load switch can pass at room ambient temperature without entering thermal lockout. See the SOA section for more information on transient current limitations.



DFN12, 3x3
CASE 506DY

MARKING DIAGRAM

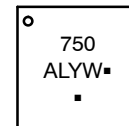

- 750 = Specific Device Code
- A = Assembly Location
- L = Wafer Lot
- Y = Year
- W = Work Week
- = Pb-Free Package

(Note: Microdot may be in either location)

PIN CONFIGURATION

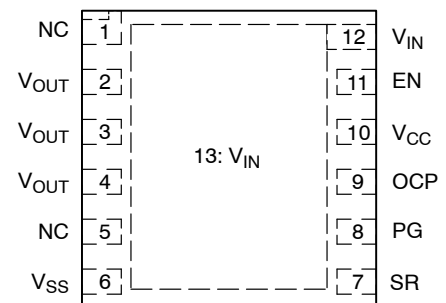

(Top View)

ORDERING INFORMATION

| Device | Package | Shipping |
|------------------|--------------------|--------------------|
| NCP45750IMN24TWG | DFN12 (RoHS/REACH) | 3000 / Tape & Reel |

NCP45750

Table 1. PIN DESCRIPTION

| Pin | Name | Function |
|---------|------------------|--|
| 2, 3, 4 | V _{OUT} | Source of MOSFET connected to load. Includes an internal bleed resistor to GND. – All pins must be connected to provide correct R_{ds}, OCP, and current capability. |
| 6 | V _{SS} | Driver ground |
| 7 | SR | Slew Rate control pin. Slew rate adjustment made with an external capacitor to GND; float if not used. |
| 8 | PG | Active–high, open–drain output that indicates when the gate of the MOSFET is fully charged, external pull up resistor ≥ 100 kΩ to an external voltage source required; tie to GND if not used. |
| 9 | OCP | Over–current protection trip point adjustment made with a resistor to ground; short to ground if over–current protection is not needed. |
| 10 | V _{CC} | Driver supply voltage (3.0 V – 5.5 V) |
| 11 | EN | Active–high digital input used to turn on the MOSFET driver, pin has an internal pull down resistor to GND |
| 12, 13 | V _{IN} | Input voltage (3 V – 24 V) – Pin 13 should be used for high current (>0.5 A) |

Table 2. ABSOLUTE MAXIMUM RATINGS

| Rating | Symbol | Value | Unit |
|--|--------------------|------------|------|
| Supply Voltage Range | V _{CC} | –0.3 to 6 | V |
| Input Voltage Range | V _{IN} | –0.3 to 30 | V |
| Output Voltage Range | V _{OUT} | –0.3 to 30 | V |
| EN Input Voltage Range | V _{EN} | –0.3 to 6 | V |
| PG Output Voltage Range (Note 1) | V _{PG} | –0.3 to 6 | V |
| OCP Input Voltage Range | V _{OCP} | –0.3 to 6 | V |
| Thermal Resistance, Junction–to–Ambient, Steady State (Note 2) | R _{θJA} | 49.7 | °C/W |
| Thermal Resistance, Junction–to–Case (V _{IN} Paddle) | R _{θJC} | 1.7 | °C/W |
| Continuous MOSFET Current @ T _A = 25°C (Note 2) | I _{MAX} | 10 | A |
| Load Power Range (Note 5) | P _{LOAD} | 100 | W |
| Storage Temperature Range | T _{STG} | –55 to 150 | °C |
| Lead Temperature, Soldering (10 sec.) | T _{SLD} | 260 | °C |
| ESD Capability, Human Body Model (Notes 3 and 4) | ESD _{HBM} | 2 | kV |
| ESD Capability, Charged Device Model (Notes 3 and 4) | ESD _{CDM} | 0.5 | kV |
| Latch–up Current Immunity (Note 3) | LU | 100 | mA |

Stresses exceeding those listed in the Maximum Ratings table may damage the device. If any of these limits are exceeded, device functionality should not be assumed, damage may occur and reliability may be affected.

1. PG is an open drain output that requires an external pull–up resistor > 100 kΩ to an external voltage source.
2. Surface–mounted on FR4 board using the minimum recommended pad size, 1 oz Cu. Over current protection will limit maximum realized current to 10 A at highest setting.
3. Tested by the following methods @ T_A = 25°C:
 ESD Human Body Model tested per JS–001
 ESD Charged Device Model per ESD JS–002
 Latch–up Current tested per JESD78
 PG, OCP, and SR pins must be correctly connected for compliance
4. Rating is for all pins except for V_{IN} and V_{OUT} which are tied to the internal MOSFET’s Drain and Source. Typical MOSFET ESD performance for V_{IN} and V_{OUT} should be expected and these devices should be treated as ESD sensitive.

NCP45750

Table 3. OPERATING RANGES

| Rating | Symbol | Min | Max | Unit |
|---|-------------|-------|------|--------------|
| VCC – ($V_{IN} > 4.5$ V) | V_{CC} | 3 | 5.5 | V |
| VCC – ($V_{IN} < 4.5$ V) | V_{CC} | 4.5 | 5.5 | V |
| VIN – ($V_{CC} > 4.5$ V) | V_{IN} | 3 | 24 | V |
| VIN – ($V_{CC} < 4.5$ V) | V_{IN} | 4.5 | 24 | V |
| OCP External Resistor to VSS | R_{OCP} | short | open | Ω |
| OFF to ON Transition Energy Dissipation Limit (See application section) | E_{TRANS} | | 100 | mJ |
| VSS | V_{SS} | | 0 | V |
| Ambient Temperature | T_A | -40 | 85 | $^{\circ}$ C |
| Junction Temperature | T_J | -40 | 125 | $^{\circ}$ C |

Functional operation above the stresses listed in the Recommended Operating Ranges is not implied. Extended exposure to stresses beyond the Recommended Operating Ranges limits may affect device reliability.

Table 4. ELECTRICAL CHARACTERISTICS ($T_J = 25^{\circ}$ C, $V_{CC} = 3$ V – 5.5 V, unless otherwise specified)

| Parameter | Conditions | Symbol | Min | Typ | Max | Unit |
|---|---|-----------------|------|-----|-----|------------|
| On-Resistance | $V_{CC} = 4.5$ V; $V_{IN} = 3$ V | R_{ON} | | 5.9 | 7.0 | m Ω |
| | $V_{CC} = 3.3$ V; $V_{IN} = 4.5$ V | | | 5.9 | 7.0 | |
| | $V_{CC} = 3.3$ V; $V_{IN} = 15$ V | | | 5.9 | 7.0 | |
| | $V_{CC} = 3.3$ V; $V_{IN} = 24$ V | | | 5.9 | 7.0 | |
| Leakage Current – V_{IN} to V_{OUT} | $V_{EN} = 0$ V; $V_{IN} = 24$ V | I_{LEAK} | | | 0.1 | μ A |
| V_{IN} Control Current – V_{IN} to V_{SS} | $V_{EN} = 0$ V; $V_{IN} = 24$ V; $V_{CC} = 3.3$ V | I_{INCTL} | | | 1.5 | μ A |
| V_{IN} Control Current – V_{IN} to V_{SS} | $V_{EN} = V_{CC} = 3.3$ V; $V_{IN} = 24$ V | I_{INCTL_EN} | | | 300 | μ A |
| Supply Standby Current (Note 5) | $V_{EN} = 0$ V; $V_{IN} = 24$ V; $V_{CC} = 3.3$ V | I_{STBY} | | 2.0 | 5.0 | μ A |
| Supply Dynamic Current (Note 6) | $V_{EN} = V_{CC} = 3.3$ V; $V_{IN} = 24$ V | I_{DYN} | | | 0.5 | mA |
| Bleed Resistance | | R_{BLEED} | 75 | 104 | 200 | k Ω |
| EN Input High Voltage | | V_{IH} | 2 | | | V |
| EN Input Low Voltage | | V_{IL} | | | 0.8 | V |
| EN Input Leakage Current | $V_{EN} = 0$ V | I_{IL} | -1.0 | | 1.0 | μ A |
| EN Pull Down Resistance | | R_{PD} | 76 | 100 | 124 | k Ω |
| PG Output Low Voltage | $I_{SINK} = 100$ μ A | V_{OL} | | | 0.1 | V |
| PG Output Leakage Current | $V_{TERM} = 3.3$ V | I_{OH} | | 3.5 | 100 | nA |
| Slew Rate Control Constant (Note 7) | SR pin floating (default) | K_{SR} | 70 | 99 | 130 | μ A |

FAULT PROTECTIONS

| | | | | | | |
|---|---|------------|------|------|------|--------------|
| Thermal Shutdown Threshold (Note 8) | | T_{SDT} | | 145 | | $^{\circ}$ C |
| Thermal Shutdown Hysteresis (Note 8) | | T_{HYS} | | 20 | | $^{\circ}$ C |
| V_{IN} Under Voltage Lockout Threshold | V_{IN} rising | V_{UVLO} | | 2.0 | 2.1 | V |
| V_{IN} Under Voltage Lockout Hysteresis | | V_{HYS} | | 220 | 300 | mV |
| Over-Current Protection Trip (Note 9) | $R_{OCP} = \text{open}$ | I_{TRIP} | 0.85 | 1.2 | 1.45 | A |
| | $R_{OCP} = 32$ k Ω | | | | | |
| | $R_{OCP} = \text{short to GND}$ (Note 10) | | | | | |
| Over-Current Protection Blanking Time | | t_{OCP} | | 2.25 | | ms |
| Short-Circuit Protection Trip Current | Soft Short & Hard Short (Note 11) | I_{SC} | | 12 | | A |

Product parametric performance is indicated in the Electrical Characteristics for the listed test conditions, unless otherwise noted. Product performance may not be indicated by the Electrical Characteristics if operated under different conditions.

5. Average current from V_{CC} to GND with MOSFET turned off.

6. Average current from V_{CC} to GND after charge up time of MOSFET.

7. See Applications Information section for details on how to adjust the gate slew rate.

8. Operation above $T_J = 125^{\circ}$ C is not guaranteed.

9. OCP Trip current limits were verified by bench test and are not guaranteed on every part.

10. Transient currents exceeding the short-circuit protection trip current will cause the device to fault. For OCP settings less than 20 k Ω , high steady state currents may cause an over temperature lockout before the OCP threshold is reached due to self-heating.

11. Short Circuit Protection protects the device against hard shorts ($R_{SHORT} \leq 250$ m Ω V_{out} to Ground) for $V_{in} < 18$ V, and against soft shorts ($R_{SHORT} > 250$ m Ω) for $V_{in} < 24$ V. Short circuit protection testing assumed a 100 W supply capability limit on V_{in} .

NCP45750

Table 5. SWITCHING CHARACTERISTICS ($T_J = 25^\circ\text{C}$ unless otherwise specified) (Notes 12 and 13)

| Parameter | Conditions | Symbol | Min | Typ | Max | Unit |
|------------------------------------|---|--------------|------|------|-----|---------------|
| Output Slew Rate – Default | $V_{CC} = 4.5\text{ V}; V_{IN} = 3\text{ V}$ | SR | 13 | 20.3 | 28 | kV/s |
| | $V_{CC} = 5.0\text{ V}; V_{IN} = 3\text{ V}$ | | 13 | 20.6 | 28 | |
| | $V_{CC} = 3.3\text{ V}; V_{IN} = 24\text{ V}$ | | 13 | 23 | 28 | |
| | $V_{CC} = 5.0\text{ V}; V_{IN} = 24\text{ V}$ | | 13 | 23 | 28 | |
| Output Turn-on Delay | $V_{CC} = 4.5\text{ V}; V_{IN} = 3\text{ V}$ | T_{ON} | 100 | 162 | 700 | μs |
| | $V_{CC} = 5.0\text{ V}; V_{IN} = 3\text{ V}$ | | 100 | 161 | 700 | |
| | $V_{CC} = 3.3\text{ V}; V_{IN} = 24\text{ V}$ | | 100 | 453 | 700 | |
| | $V_{CC} = 5.0\text{ V}; V_{IN} = 24\text{ V}$ | | 100 | 448 | 700 | |
| Output Turn-off Delay | $V_{CC} = 4.5\text{ V}; V_{IN} = 3\text{ V}$ | T_{OFF} | | 60 | | μs |
| | $V_{CC} = 5.0\text{ V}; V_{IN} = 3\text{ V}$ | | | 60 | | |
| | $V_{CC} = 3.3\text{ V}; V_{IN} = 24\text{ V}$ | | | 40 | | |
| | $V_{CC} = 5.0\text{ V}; V_{IN} = 24\text{ V}$ | | | 40 | | |
| Power Good Turn-on Time | $V_{CC} = 4.5\text{ V}; V_{IN} = 3\text{ V}$ | $T_{PG,ON}$ | 0.25 | 0.5 | 2.5 | ms |
| | $V_{CC} = 5.0\text{ V}; V_{IN} = 3\text{ V}$ | | 0.25 | 0.5 | 2.5 | |
| | $V_{CC} = 3.3\text{ V}; V_{IN} = 24\text{ V}$ | | 0.25 | 1.7 | 2.5 | |
| | $V_{CC} = 5.0\text{ V}; V_{IN} = 24\text{ V}$ | | 0.25 | 1.5 | 2.5 | |
| Power Good Turn-off Time (Note 14) | $V_{CC} = 4.5\text{ V}; V_{IN} = 3\text{ V}$ | $T_{PG,OFF}$ | | | 10 | ns |
| | $V_{CC} = 5.0\text{ V}; V_{IN} = 3\text{ V}$ | | | | 10 | |
| | $V_{CC} = 3.3\text{ V}; V_{IN} = 24\text{ V}$ | | | | 10 | |
| | $V_{CC} = 5.0\text{ V}; V_{IN} = 24\text{ V}$ | | | | 10 | |

12. See below figure for Test Circuit and Timing Diagram.

13. Tested with the following conditions: $V_{TERM} = V_{CC}$; $R_{PG} = 100\text{ k}\Omega$; $R_L = 10\ \Omega$; $C_L = 0.1\ \mu\text{F}$.

14. Power Good Turn-off Time is highly dependent on external pull up resistor value and external capacitive loading. 100 k Ω pull up to 3.3 V was used in test.

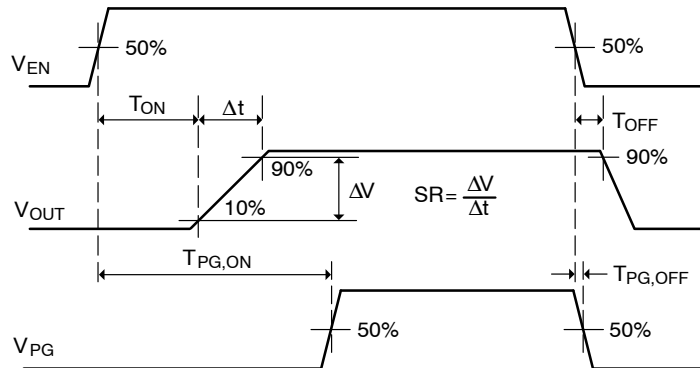
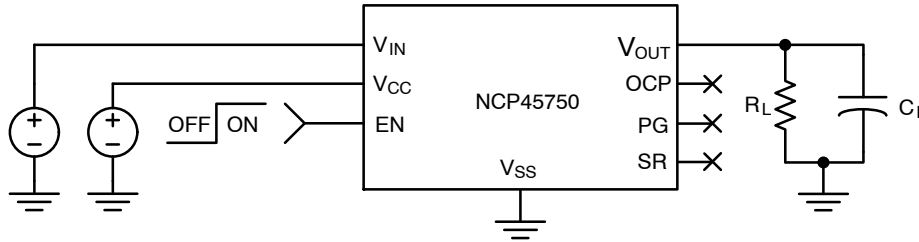

Figure 2. Switching Characteristics Test Circuit and Timing Diagrams

TYPICAL CHARACTERISTICS

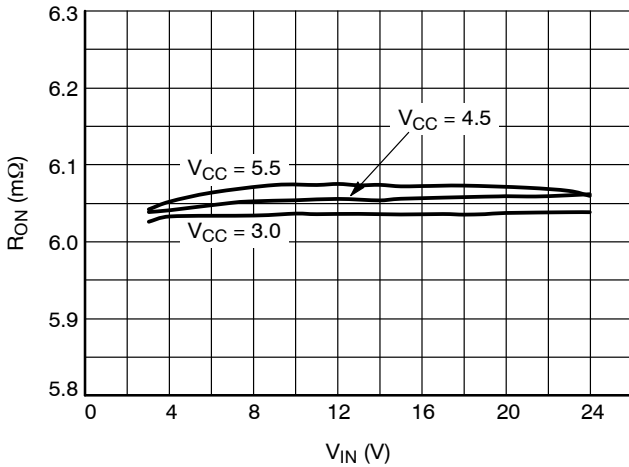

Figure 3. On-Resistance vs. Input Voltage

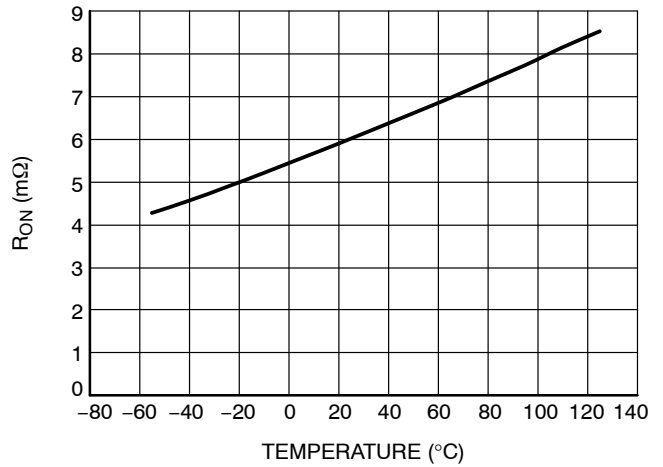

Figure 4. On-Resistance vs. Temperature

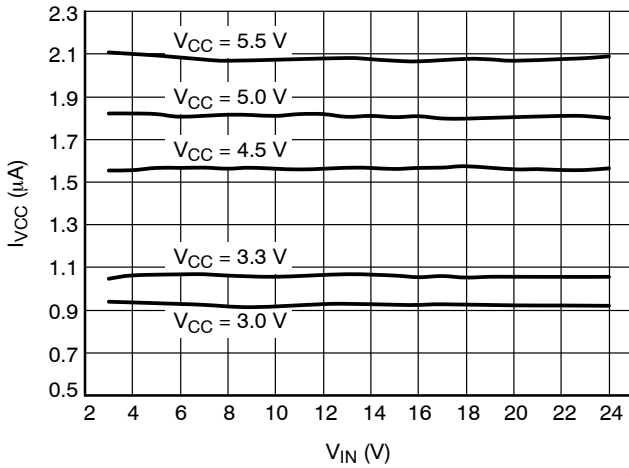

Figure 5. Supply Standby Current vs. Supply Voltage

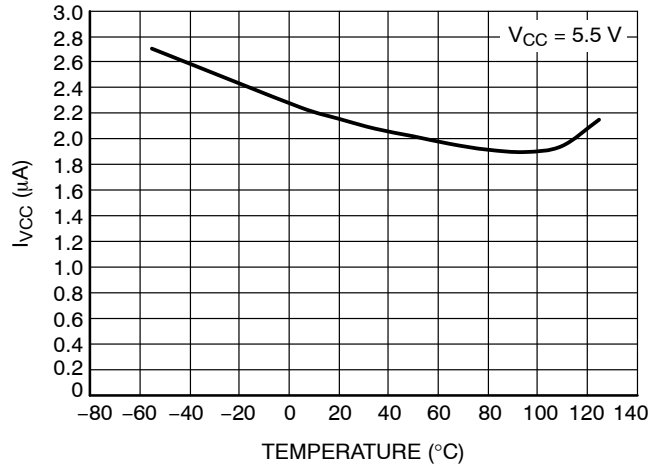

Figure 6. Supply Standby Current vs. Temperature

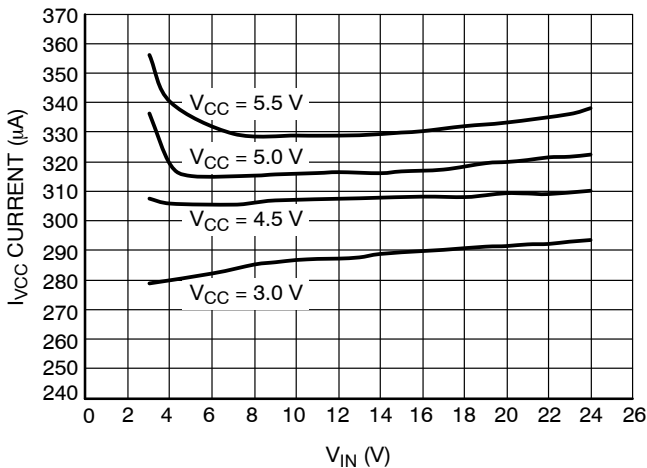

Figure 7. Dynamic Current vs. Input Voltage

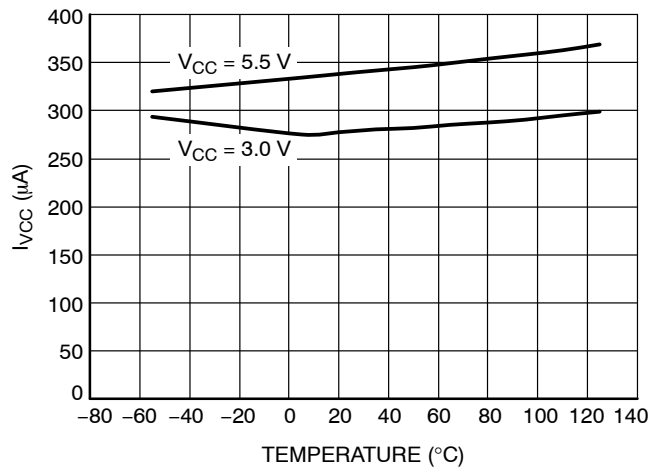

Figure 8. Supply Dynamic Current vs. Temperature

TYPICAL CHARACTERISTICS

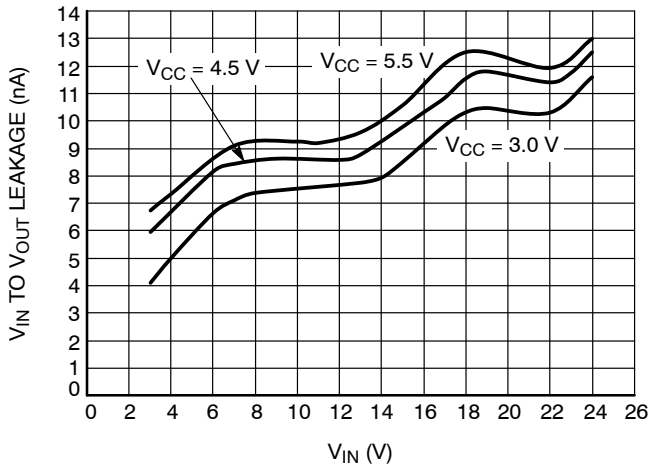

Figure 9. Input to Output Leakage vs. Input Voltage (EN = 0)

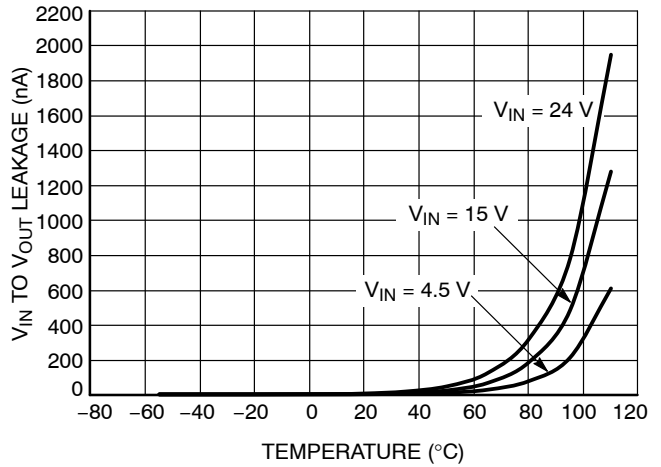

Figure 10. Input to Output Leakage vs. Temperature (EN = 0)

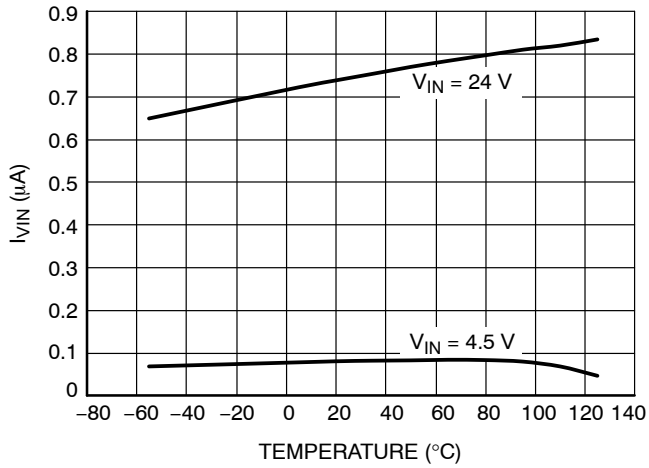

Figure 11. Vin Controller Current vs. Temperature (EN = 0)

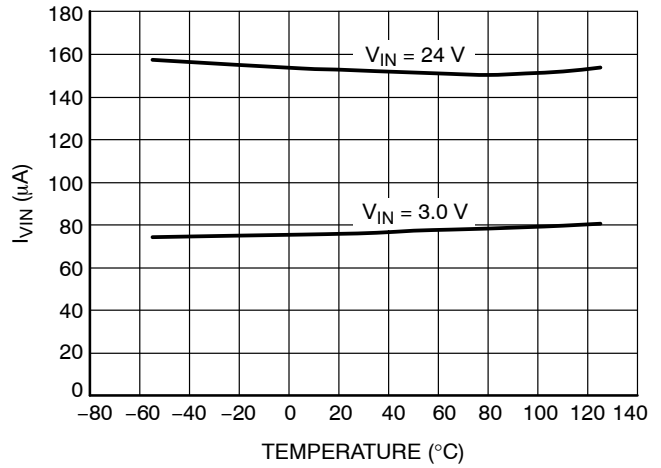

Figure 12. Vin Controller Current vs. Temperature (EN = HIGH)

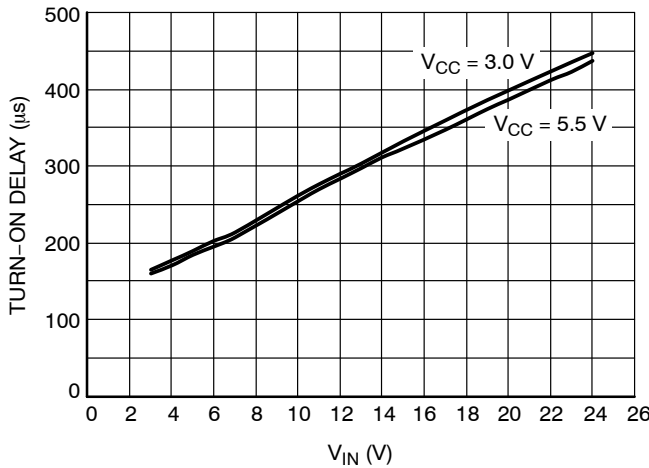

Figure 13. Output Turn-on Delay vs. Input Voltage

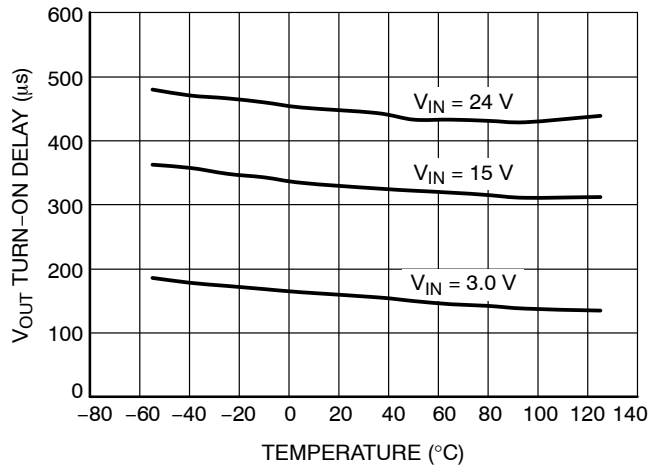

Figure 14. Output Turn-on Delay vs. Temperature

TYPICAL CHARACTERISTICS

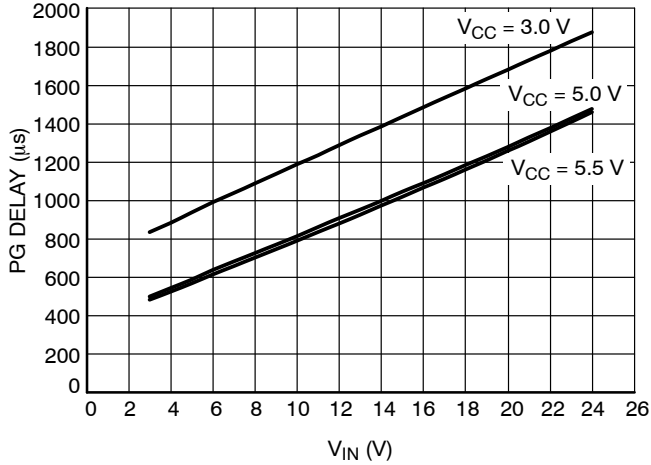

Figure 15. Power Good Turn-on Time vs. Input Voltage

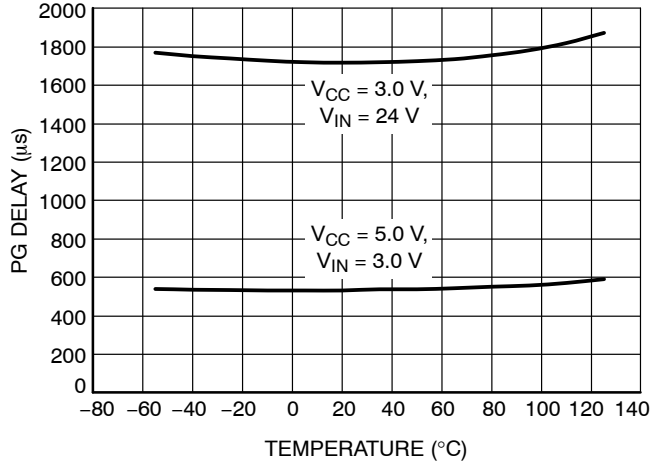

Figure 16. Power Good Turn-on vs. Temperature

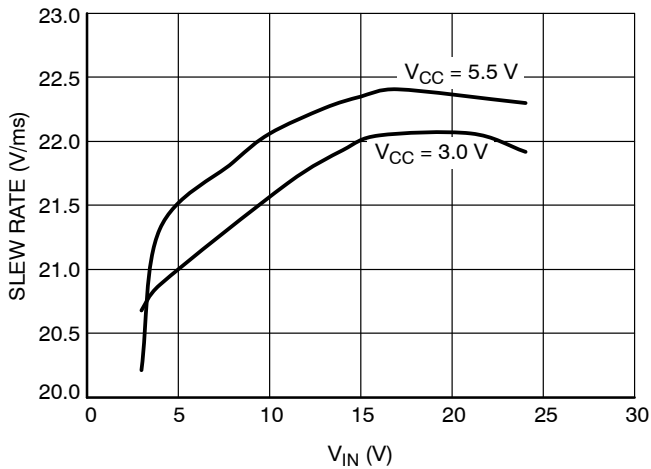

Figure 17. Default Slew Rate vs. Input Voltage

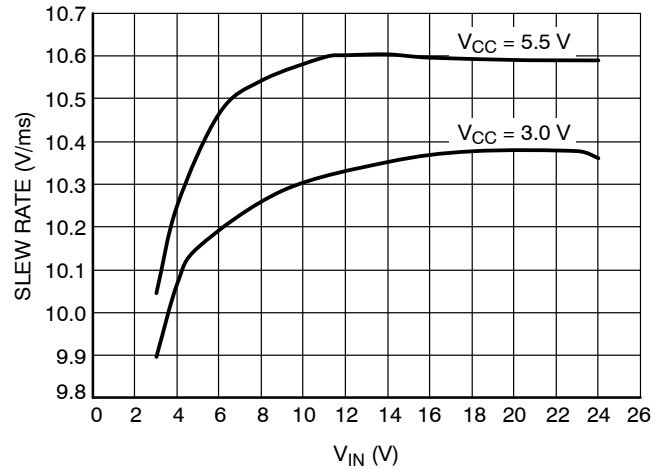

Figure 18. Slew Rate vs. Input Voltage (SR pin = 10 nF to GND)

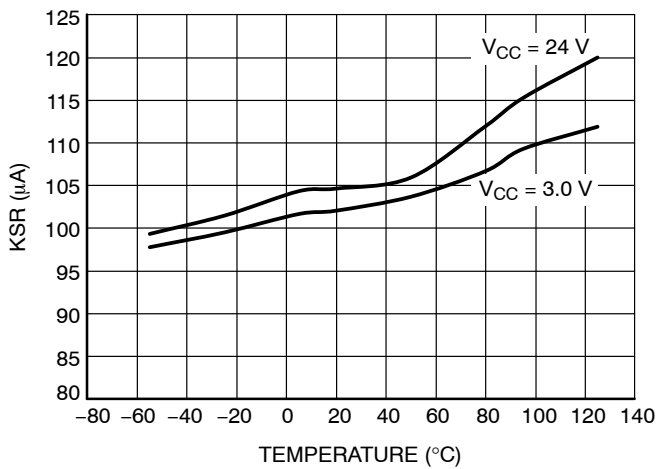

Figure 19. KSR vs. Temperature

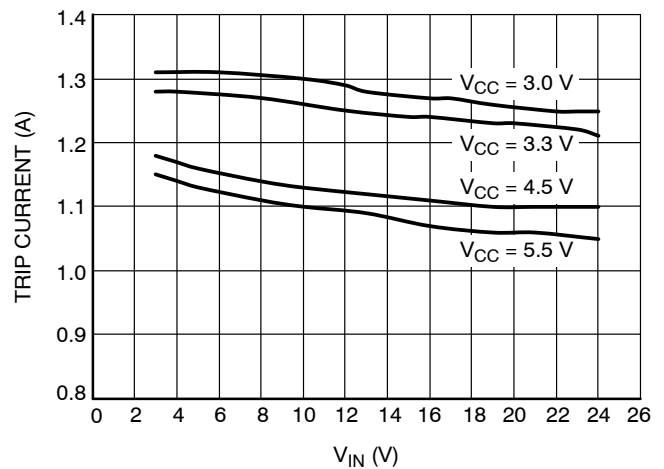

Figure 20. OCP Trip Current vs. Input Voltage (OCP = Float)

NCP45750

TYPICAL CHARACTERISTICS

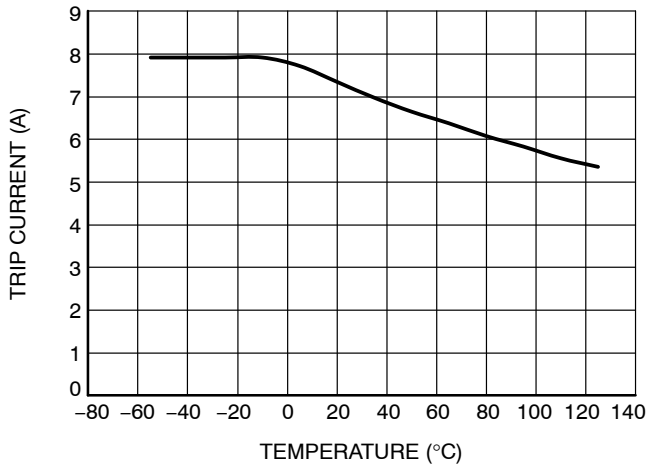

Figure 21. OCP Trip Current vs. Temperature (OCP = 32 kΩ)

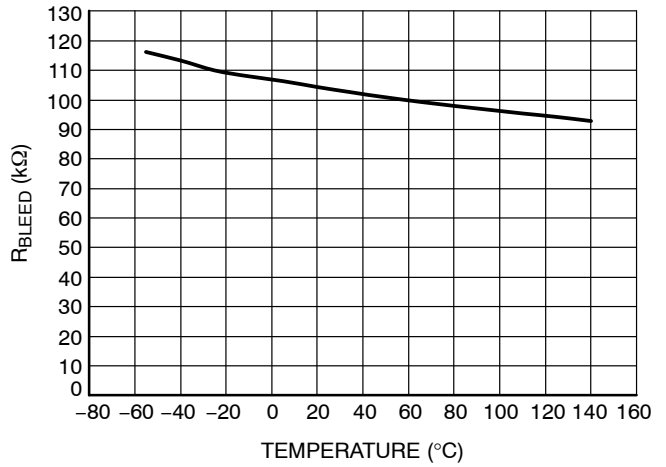

Figure 22. R_BLEED vs. Temperature

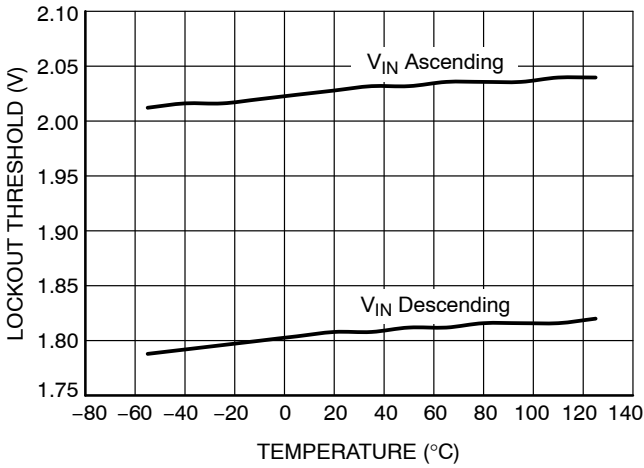

Figure 23. UVLO Trip Voltage vs. Temperature

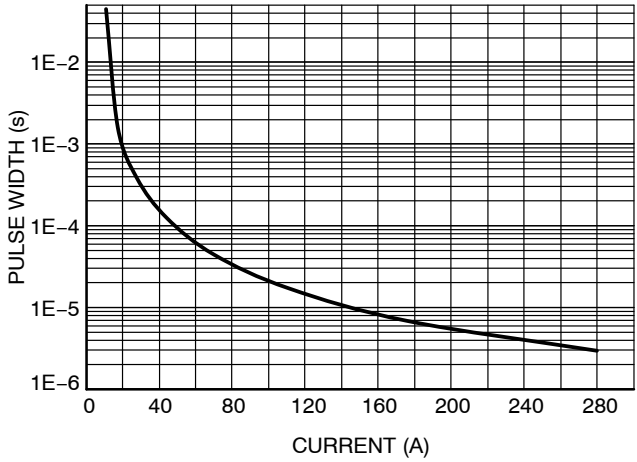

Figure 24. Safe Operating Area Transient Current

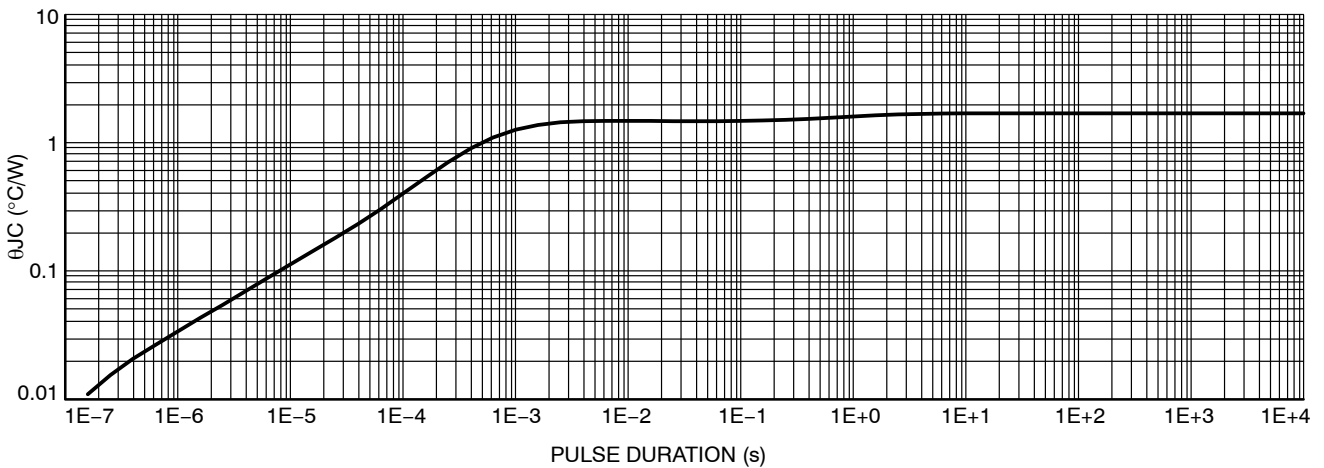

Figure 25. Transient Thermal Response

APPLICATIONS INFORMATION

Enable Control

The NCP45750 part enables the MOSFET in an active-high configuration. When the EN pin is at a logic high level and the V_{CC} supply pin has an adequate voltage applied, the MOSFET will be enabled. When the EN pin is at a logic low level, the MOSFET will be disabled. An internal pull down resistor to ground on the EN pin ensures that the MOSFET will be disabled when not driven.

Short-Circuit Protection

The NCP45750 device is equipped with a short-circuit protection that helps protect the part and the system from a sudden high-current event, such as the output, V_{OUT}, being hard-shorted to ground.

Once active, the circuitry monitors the voltage difference between the V_{IN} pin and the V_{OUT} pin. When the difference is equal to the short-circuit protection threshold voltage, the MOSFET is turned off and the load bleed is activated. The part remains off and is latched in the Fault state until EN is toggled or V_{CC} supply voltage is cycled, at which point the MOSFET will be turned on in a controlled fashion with the normal output turn-on delay and slew rate. The short circuit protection feature protects the device from hard shorts (R_{SHORT} < 250 mΩ V_{OUT} to GND) for V_{IN} ≤ 18 V. Hard short circuit testing used a 10 mΩ short to ground for this scenario. The short circuit protection circuitry remains active regardless of the EN state to protect against enabling into a short circuit.

Over-Current Protection

The NCP45750 device is equipped with an over-current protection (OCP) that helps protect the part and the system from a high current event which exceeds the expected operational current (e.g., a soft short).

In the event that the current from the V_{IN} pin to the V_{OUT} pin exceeds the OCP threshold for longer than the blanking time, the MOSFET will shut down and the PG pin is driven low. Like the short-circuit protection, the part remains latched in the Fault state until EN is toggled or V_{CC} supply voltage is cycled, at which point the MOSFET will be turned on in a controlled fashion with the normal output turn-on delay and slew rate.

The over-current trip point is determined by the resistance between the OCP pin and ground. If no over-current protection is needed, then the OCP pin should be tied to GND; if the OCP protection is disabled in this way, the short-circuit protection will still remain active.

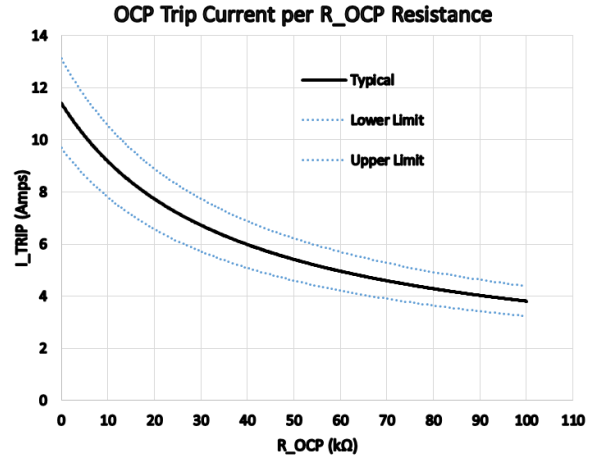

Figure 26. OCP Trip Current Setting

Thermal Shutdown

The thermal shutdown of the NCP45750 device protects the part from internally or externally generated excessive temperatures. This circuitry is disabled when EN is not active to reduce standby current. When an over-temperature condition is detected, the MOSFET is turned off and the load bleed is activated.

The part comes out of thermal shutdown when the junction temperature decreases to a safe operating temperature as dictated by the thermal hysteresis. Upon exiting a thermal shutdown state, and if EN remains active, the MOSFET will be turned on in a controlled fashion with the normal output turn-on delay and slew rate.

Under Voltage Lockout

The under voltage lockout of the NCP45750 device turns the MOSFET off and activates the load bleed when the input voltage, V_{IN}, drops below the under voltage lockout threshold. This circuitry is disabled when EN is not active to reduce standby current.

If the V_{IN} voltage rises above the under voltage lockout threshold, and EN remains active, the MOSFET will be turned on in a controlled fashion with the normal output turn-on delay and slew rate.

Power Good

The NCP45750 device has a power good output (PG) that can be used to indicate when the gate of the MOSFET is fully charged. The PG pin is an active-high, open-drain output

that requires an external pull up resistor, RPG, greater than or equal to 100 kΩ to an external voltage source.

The power good output can be used as the enable signal for other active-high devices in the system. This allows for guaranteed by design power sequencing and reduces the number of enable signals needed from the system controller. If the power good feature is not used in the application, the PG pin should be tied to GND.

Slew Rate Control

The NCP45750 device is equipped with controlled output slew rate which provides soft start functionality. This limits the inrush current caused by capacitor charging and enables these devices to be used in hot swapping applications.

The slew rate can be decreased with an external capacitor added between the SR pin and ground. With an external capacitor present, the slew rate can be determined by the following equation:

$$\text{Slew Rate} = \frac{K_{SR}}{C_{SR}} \left[\frac{V}{s} \right] \quad (\text{eq. 1})$$

where K_{SR} is the specified slew rate control constant, found on page 3, and C_{SR} is the capacitor added between the SR pin and ground. Note that the slew rate of the device will always be the lower of the default slew rate and the adjusted slew rate. Therefore, if the C_{SR} is not large enough to decrease the slew rate more than the specified default value, the slew rate of the device will be the default value.

Capacitive Load

The peak in-rush current associated with the initial charging of the application load capacitance needs to stay below the specified I_{max} . C_L (capacitive load) should be less than C_{max} as defined by the following equation:

$$C_{max} = \frac{I_{max}}{SR_{typ}} \quad (\text{eq. 2})$$

where I_{max} is the maximum load current, and SR_{typ} is the typical default slew rate when no external load capacitor is added to the SR pin.

OFF to ON Transition Energy Dissipation

The energy dissipation due to load current traveling from V_{IN} to V_{OUT} is very low during steady state operation due

to the low R_{ON} . When the EN signal is asserted high, the load switch transitions from an OFF state to an ON state. During this time, the resistance from V_{IN} to V_{OUT} transitions from high impedance to R_{ON} , and additional energy is dissipated in the device for a short period of time. The worst case energy dissipated during the OFF to ON transition can be approximated by the following equation:

$$E = 0.5 \cdot V_{IN} \cdot (I_{INRUSH} + 0.8 \cdot I_{LOAD}) \cdot dt \quad (\text{eq. 3})$$

where V_{IN} is the voltage on the V_{IN} pin, I_{INRUSH} is the inrush current caused by capacitive loading on V_{OUT} , and dt is the time it takes V_{OUT} to rise from 0 V to V_{IN} . I_{INRUSH} can be calculated using the following equation:

$$I_{INRUSH} = \frac{dv}{dt} \cdot C_L \quad (\text{eq. 4})$$

where dv/dt is the programmed slew rate, and C_L is the capacitive loading on V_{OUT} . To prevent thermal lockout or damage to the device, the energy dissipated during the OFF to ON transition should be limited to E_{TRANS} listed in operating ranges table.

ecoSWITCH LAYOUT GUIDELINES

Electrical Layout Considerations

Correct physical PCB layout is important for proper low noise accurate operation of all ecoSWITCH products.

Power Planes: The ecoSWITCH is optimized for extremely low R_{on} resistance, however, improper PCB layout can substantially increase source to load series resistance by adding PCB board parasitic resistance. Solid connections to the V_{IN} and V_{OUT} pins of the ecoSWITCH to copper planes should be used to achieve low series resistance and good thermal dissipation. The ecoSWITCH requires ample heat dissipation for correct thermal lockout operation. The internal FET dissipates load condition dependent amounts of power in the milliseconds following the rising edge of enable, and providing good thermal conduction from the packaging to the board is critical. Direct coupling of V_{IN} to V_{OUT} should be avoided, as this will adversely affect slew rates.

MECHANICAL CASE OUTLINE PACKAGE DIMENSIONS



SCALE 2:1

DFN12 3x3, 0.5P
CASE 506DY
ISSUE A

DATE 26 OCT 2022

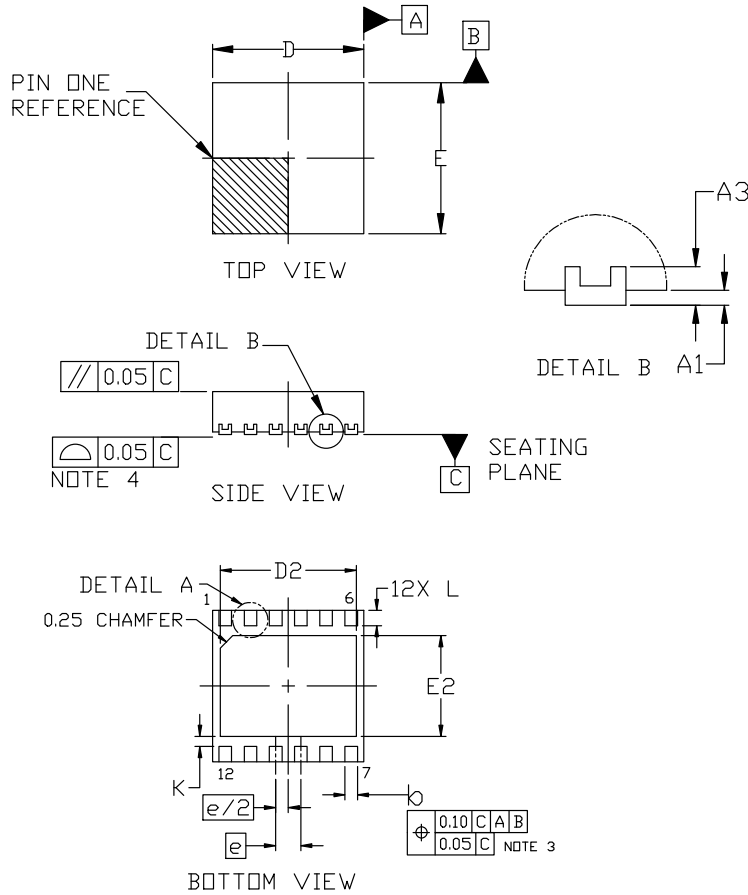

NOTES:

1. DIMENSIONING AND TOLERANCING PER ASME Y14.5M, 1994.
2. CONTROLLING DIMENSION: MILLIMETERS
3. DIMENSION *b* APPLIES TO PLATED TERMINALS AND IS MEASURED BETWEEN 0.15 AND 0.30MM FROM THE TERMINAL TIP.
4. COPLANARITY APPLIES TO THE EXPOSED PAD AS WELL AS THE TERMINALS.

| DIM | MILLIMETERS | | |
|-----|-------------|------|------|
| | MIN. | NOM. | MAX. |
| A | 0.80 | 0.85 | 0.90 |
| A1 | --- | --- | 0.05 |
| A3 | 0.20 REF | | |
| b | 0.20 | 0.25 | 0.30 |
| D | 2.90 | 3.00 | 3.10 |
| D2 | 2.40 | 2.50 | 2.60 |
| E | 2.90 | 3.00 | 3.10 |
| E2 | 1.80 | 1.90 | 2.00 |
| e | 0.50 BSC | | |
| K | 0.25 REF | | |
| L | 0.20 | 0.30 | 0.40 |

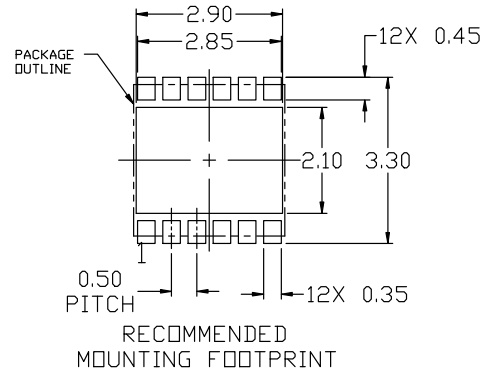

* For additional information on our Pb-Free strategy and soldering details, please download the DN Semiconductor Soldering and Mounting Techniques Reference Manual, SOLDERRM/D.

GENERIC MARKING DIAGRAM*

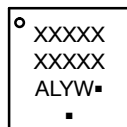

XXXXX = Specific Device Code
A = Assembly Location
L = Wafer Lot
Y = Year
W = Work Week
▪ = Pb-Free Package

(Note: Microdot may be in either location)

*This information is generic. Please refer to device data sheet for actual part marking. Pb-Free indicator, "G" or microdot "▪", may or may not be present. Some products may not follow the Generic Marking.

| | | |
|-------------------------|------------------------|--|
| DOCUMENT NUMBER: | 98AON65584G | Electronic versions are uncontrolled except when accessed directly from the Document Repository. Printed versions are uncontrolled except when stamped "CONTROLLED COPY" in red. |
| DESCRIPTION: | DFN12 3X3, 0.5P | PAGE 1 OF 1 |

onsemi and ONSEMI are trademarks of Semiconductor Components Industries, LLC dba onsemi or its subsidiaries in the United States and/or other countries. onsemi reserves the right to make changes without further notice to any products herein. onsemi makes no warranty, representation or guarantee regarding the suitability of its products for any particular purpose, nor does onsemi assume any liability arising out of the application or use of any product or circuit, and specifically disclaims any and all liability, including without limitation special, consequential or incidental damages. onsemi does not convey any license under its patent rights nor the rights of others.

onsemi, **Onsemi**, and other names, marks, and brands are registered and/or common law trademarks of Semiconductor Components Industries, LLC dba "**onsemi**" or its affiliates and/or subsidiaries in the United States and/or other countries. **onsemi** owns the rights to a number of patents, trademarks, copyrights, trade secrets, and other intellectual property. A listing of **onsemi**'s product/patent coverage may be accessed at www.onsemi.com/site/pdf/Patent-Marking.pdf. **onsemi** reserves the right to make changes at any time to any products or information herein, without notice. The information herein is provided "as-is" and **onsemi** makes no warranty, representation or guarantee regarding the accuracy of the information, product features, availability, functionality, or suitability of its products for any particular purpose, nor does **onsemi** assume any liability arising out of the application or use of any product or circuit, and specifically disclaims any and all liability, including without limitation special, consequential or incidental damages. Buyer is responsible for its products and applications using **onsemi** products, including compliance with all laws, regulations and safety requirements or standards, regardless of any support or applications information provided by **onsemi**. "Typical" parameters which may be provided in **onsemi** data sheets and/or specifications can and do vary in different applications and actual performance may vary over time. All operating parameters, including "Typicals" must be validated for each customer application by customer's technical experts. **onsemi** does not convey any license under any of its intellectual property rights nor the rights of others. **onsemi** products are not designed, intended, or authorized for use as a critical component in life support systems or any FDA Class 3 medical devices or medical devices with a same or similar classification in a foreign jurisdiction or any devices intended for implantation in the human body. Should Buyer purchase or use **onsemi** products for any such unintended or unauthorized application, Buyer shall indemnify and hold **onsemi** and its officers, employees, subsidiaries, affiliates, and distributors harmless against all claims, costs, damages, and expenses, and reasonable attorney fees arising out of, directly or indirectly, any claim of personal injury or death associated with such unintended or unauthorized use, even if such claim alleges that **onsemi** was negligent regarding the design or manufacture of the part. **onsemi** is an Equal Opportunity/Affirmative Action Employer. This literature is subject to all applicable copyright laws and is not for resale in any manner.

ADDITIONAL INFORMATION

TECHNICAL PUBLICATIONS:

Technical Library: www.onsemi.com/design/resources/technical-documentation
onsemi Website: www.onsemi.com

ONLINE SUPPORT: www.onsemi.com/support

For additional information, please contact your local Sales Representative at www.onsemi.com/support/sales