

# ecoSWITCH™

## Advanced Load Management

### Controlled Load Switch with Low $R_{ON}$

## NCP45560

The NCP45560 load switch provides a component and area-reducing solution for efficient power domain switching with inrush current limit via soft-start. In addition to integrated control functionality with ultra low on-resistance, this device offers system safeguards and monitoring via fault protection and power good signaling. This cost effective solution is ideal for power management and hot-swap applications requiring low power consumption in a small footprint.

### Features

- Advanced Controller with Charge Pump
- Integrated N-Channel MOSFET with Ultra Low  $R_{ON}$
- Input Voltage Range 0.5 V to 13.5 V
- Soft-Start via Controlled Slew Rate
- Adjustable Slew Rate Control
- Power Good Signal
- Thermal Shutdown
- Undervoltage Lockout
- Short-Circuit Protection
- Extremely Low Standby Current
- Load Bleed (Quick Discharge)
- This is a Pb-Free Device

### Typical Applications

- Portable Electronics and Systems
- Notebook and Tablet Computers
- Telecom, Networking, Medical, and Industrial Equipment
- Set-Top Boxes, Servers, and Gateways
- Hot-Swap Devices and Peripheral Ports

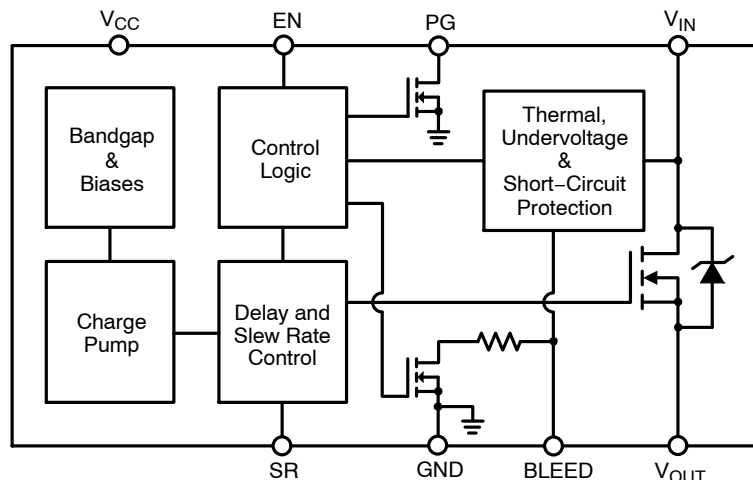

Figure 1. Block Diagram



ON Semiconductor®

[www.onsemi.com](http://www.onsemi.com)

$R_{ON}$ TYP	$V_{CC}$	$V_{IN}$	$I_{MAX\_DC}^*$
4.1 m $\Omega$	3.3 V	1.8 V	17 A
4.3 m $\Omega$	3.3 V	5.0 V	
4.9 m $\Omega$	3.3 V	12 V	

\* $I_{MAX\_DC}$  is defined as the maximum steady state current the load switch can pass at room ambient temperature without entering thermal lockout.

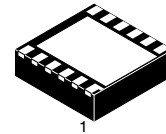

DFN12, 3x3  
CASE 506CD

### MARKING DIAGRAM

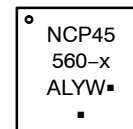

x = H for NCP45560-H  
 = L for NCP45560-L  
 A = Assembly Location  
 L = Wafer Lot  
 Y = Year  
 W = Work Week  
 ■ = Pb-Free Package

(Note: Microdot may be in either location)

### PIN CONFIGURATION

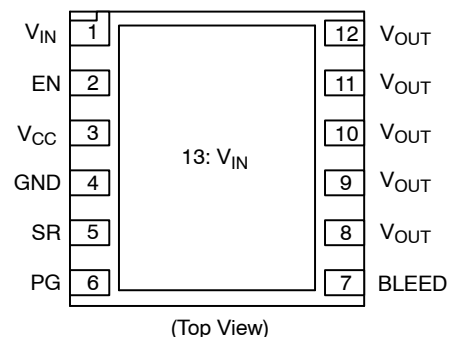

(Top View)

### ORDERING INFORMATION

See detailed ordering and shipping information on page 13 of this data sheet.

# NCP45560

**Table 1. PIN DESCRIPTION**

Pin	Name	Function
1, 13	V <sub>IN</sub>	Drain of MOSFET (0.5 V – 13.5 V), Pin 1 must be connected to Pin 13
2	EN	NCP45560–H – Active–high digital input used to turn on the MOSFET, pin has an internal pull down resistor to GND
		NCP45560–L – Active–low digital input used to turn on the MOSFET, pin has an internal pull up resistor to V <sub>CC</sub>
3	V <sub>CC</sub>	Supply voltage to controller (3.0 V – 5.5 V)
4	GND	Controller ground
5	SR	Slew rate adjustment; float if not used
6	PG	Active–high, open–drain output that indicates when the gate of the MOSFET is fully charged, external pull up resistor ≥ 1 kΩ to an external voltage source required; tie to GND if not used.
7	BLEED	Load bleed connection, must be tied to V <sub>OUT</sub> either directly or through a resistor ≤ 1 kΩ
8–12	V <sub>OUT</sub>	Source of MOSFET connected to load

**Table 2. ABSOLUTE MAXIMUM RATINGS**

Rating	Symbol	Value	Unit
Supply Voltage Range	V <sub>CC</sub>	–0.3 to 6	V
Input Voltage Range	V <sub>IN</sub>	–0.3 to 18	V
Output Voltage Range	V <sub>OUT</sub>	–0.3 to 18	V
EN Digital Input Range	V <sub>EN</sub>	–0.3 to (V <sub>CC</sub> + 0.3)	V
PG Output Voltage Range (Note 1)	V <sub>PG</sub>	–0.3 to 6	V
Thermal Resistance, Junction–to–Ambient, Steady State (Note 2)	R <sub>θJA</sub>	28.6	°C/W
Thermal Resistance, Junction–to–Ambient, Steady State (Note 3)	R <sub>θJA</sub>	49.7	°C/W
Thermal Resistance, Junction–to–Case (V <sub>IN</sub> Paddle)	R <sub>θJC</sub>	1.7	°C/W
Continuous MOSFET Current @ T <sub>A</sub> = 25°C (Notes 3 and 4)	I <sub>MAX</sub>	17	A
Continuous MOSFET Current @ T <sub>A</sub> = 25°C (Notes 2 and 4)	I <sub>MAX</sub>	18.3	A
Transient MOSFET Current (for up to 500 μs)	I <sub>MAX_TRANS</sub>	40	A
Total Power Dissipation @ T <sub>A</sub> = 25°C (Note 2) Derate above T <sub>A</sub> = 25°C	P <sub>D</sub>	3.49 34.9	W mW/°C
Total Power Dissipation @ T <sub>A</sub> = 25°C (Note 3) Derate above T <sub>A</sub> = 25°C	P <sub>D</sub>	2.01 20.1	W mW/°C
Storage Temperature Range	T <sub>STG</sub>	–40 to 150	°C
Lead Temperature, Soldering (10 sec.)	T <sub>SLD</sub>	260	°C
ESD Capability, Human Body Model (Notes 5 and 6)	ESD <sub>HBM</sub>	3.0	kV
ESD Capability, Machine Model (Note 5)	ESD <sub>MM</sub>	200	V
ESD Capability, Charged Device Model (Note 5)	ESD <sub>CDM</sub>	1.0	kV
Latch–up Current Immunity (Notes 5 and 6)	LU	100	mA

Stresses exceeding those listed in the Maximum Ratings table may damage the device. If any of these limits are exceeded, device functionality should not be assumed, damage may occur and reliability may be affected.

- PG is an open–drain output that requires an external pull up resistor ≥ 1 kΩ to an external voltage source.
- Surface–mounted on FR4 board using 1 sq–in pad, 1 oz Cu.
- Surface–mounted on FR4 board using the minimum recommended pad size, 1 oz Cu.
- Ensure that the expected operating MOSFET current will not cause the Short–Circuit Protection to turn the MOSFET off undesirably.
- Tested by the following methods @ T<sub>A</sub> = 25°C:  
 ESD Human Body Model tested per JESD22–A114  
 ESD Machine Model tested per JESD22–A115  
 ESD Charged Device Model per ESD STM5.3.1  
 Latch–up Current tested per JESD78
- Rating is for all pins except for V<sub>IN</sub> and V<sub>OUT</sub> which are tied to the internal MOSFET’s Drain and Source. Typical MOSFET ESD performance for V<sub>IN</sub> and V<sub>OUT</sub> should be expected and these devices should be treated as ESD sensitive.

# NCP45560

**Table 3. OPERATING RANGES**

Rating	Symbol	Min	Max	Unit
Supply Voltage	$V_{CC}$	3	5.5	V
Input Voltage	$V_{IN}$	0.5	13.5	V
Ground	GND		0	V
Ambient Temperature	$T_A$	-40	85	°C
Junction Temperature	$T_J$	-40	125	°C
OFF to ON Transition Energy Dissipation Limit (See application section)	$E_{TRANS}$	0	210	mJ

**Table 4. ELECTRICAL CHARACTERISTICS** ( $T_J = 25^\circ\text{C}$  unless otherwise specified)

Parameter	Conditions (Note 7)	Symbol	Min	Typ	Max	Unit
<b>MOSFET</b>						
On-Resistance	$V_{CC} = 3.3\text{ V}; V_{IN} = 1.8\text{ V}$	$R_{ON}$		4.1	5.0	m $\Omega$
	$V_{CC} = 3.3\text{ V}; V_{IN} = 5\text{ V}$			4.3	5.3	
	$V_{CC} = 3.3\text{ V}; V_{IN} = 12\text{ V}$			4.9	6.8	
Leakage Current (Note 8)	$V_{EN} = 0\text{ V}; V_{IN} = 13.5\text{ V}$	$I_{LEAK}$		0.1	1.0	$\mu\text{A}$
<b>CONTROLLER</b>						
Supply Standby Current (Note 9)	$V_{EN} = 0\text{ V}; V_{CC} = 3\text{ V}$	$I_{STBY}$		0.65	2.0	$\mu\text{A}$
	$V_{EN} = 0\text{ V}; V_{CC} = 5.5\text{ V}$			3.2	4.5	
Supply Dynamic Current (Note 10)	$V_{EN} = V_{CC} = 3\text{ V}; V_{IN} = 12\text{ V}$	$I_{DYN}$		280	400	$\mu\text{A}$
	$V_{EN} = V_{CC} = 5.5\text{ V}; V_{IN} = 1.8\text{ V}$			530	750	
Bleed Resistance	$V_{EN} = 0\text{ V}; V_{CC} = 3\text{ V}$	$R_{BLEED}$	86	115	144	$\Omega$
	$V_{EN} = 0\text{ V}; V_{CC} = 5.5\text{ V}$		72	97	121	
Bleed Pin Leakage Current	$V_{EN} = V_{CC} = 3\text{ V}; V_{IN} = 1.8\text{ V}$	$I_{BLEED}$		6.0	10	$\mu\text{A}$
	$V_{EN} = V_{CC} = 3\text{ V}; V_{IN} = 12\text{ V}$			60	70	
EN Input High Voltage	$V_{CC} = 3\text{ V} - 5.5\text{ V}$	$V_{IH}$	2.0			V
EN Input Low Voltage	$V_{CC} = 3\text{ V} - 5.5\text{ V}$	$V_{IL}$			0.8	V
EN Input Leakage Current	NCP45560-H; $V_{EN} = 0\text{ V}$	$I_{IL}$		90	500	nA
	NCP45560-L; $V_{EN} = V_{CC}$	$I_{IH}$		90	500	
EN Pull Down Resistance	NCP45560-H	$R_{PD}$	76	100	124	k $\Omega$
EN Pull Up Resistance	NCP45560-L	$R_{PU}$	76	100	124	k $\Omega$
PG Output Low Voltage (Note 11)	$V_{CC} = 3\text{ V}; I_{SINK} = 5\text{ mA}$	$V_{OL}$			0.2	V
PG Output Leakage Current (Note 12)	$V_{CC} = 3\text{ V}; V_{TERM} = 3.3\text{ V}$	$I_{OH}$		5.0	100	nA
Slew Rate Control Constant (Note 13)	$V_{CC} = 3\text{ V}$	$K_{SR}$	26	33	40	$\mu\text{A}$
<b>FAULT PROTECTIONS</b>						
Thermal Shutdown Threshold (Note 14)	$V_{CC} = 3\text{ V} - 5.5\text{ V}$	$T_{SDT}$		145		°C
Thermal Shutdown Hysteresis (Note 14)	$V_{CC} = 3\text{ V} - 5.5\text{ V}$	$T_{HYS}$		20		°C
$V_{IN}$ Undervoltage Lockout Threshold	$V_{CC} = 3\text{ V}$	$V_{UVLO}$	0.25	0.35	0.45	V
$V_{IN}$ Undervoltage Lockout Hysteresis	$V_{CC} = 3\text{ V}$	$V_{HYS}$	25	40	60	mV
Short-Circuit Protection Threshold	$V_{CC} = 3\text{ V}; V_{IN} = 0.5\text{ V}$	$V_{SC}$	200	265	350	mV
	$V_{CC} = 3\text{ V}; V_{IN} = 13.5\text{ V}$		100	285	500	

7.  $V_{EN}$  shown only for NCP45560-H, (EN Active-High) unless otherwise specified.

8. Average current from  $V_{IN}$  to  $V_{OUT}$  with MOSFET turned off.

9. Average current from  $V_{CC}$  to GND with MOSFET turned off.

10. Average current from  $V_{CC}$  to GND after charge up time of MOSFET.

11. PG is an open-drain output that is pulled low when the MOSFET is disabled.

12. PG is an open-drain output that is not driven when the gate of the MOSFET is fully charged, requires an external pull up resistor  $\geq 1\text{ k}\Omega$  to an external voltage source,  $V_{TERM}$ .

13. See Applications Information section for details on how to adjust the slew rate.

14. Operation above  $T_J = 125^\circ\text{C}$  is not guaranteed.

Product parametric performance is indicated in the Electrical Characteristics for the listed test conditions, unless otherwise noted. Product performance may not be indicated by the Electrical Characteristics if operated under different conditions.

# NCP45560

**Table 5. SWITCHING CHARACTERISTICS** ( $T_J = 25^\circ\text{C}$  unless otherwise specified) (Notes 15 and 16)

Parameter	Conditions	Symbol	Min	Typ	Max	Unit
Output Slew Rate	$V_{CC} = 3.3\text{ V}; V_{IN} = 1.8\text{ V}$	SR		12.4		kV/s
	$V_{CC} = 5.0\text{ V}; V_{IN} = 1.8\text{ V}$			12.6		
	$V_{CC} = 3.3\text{ V}; V_{IN} = 12\text{ V}$			13.7		
	$V_{CC} = 5.0\text{ V}; V_{IN} = 12\text{ V}$			14.0		
Output Turn-on Delay	$V_{CC} = 3.3\text{ V}; V_{IN} = 1.8\text{ V}$	$T_{ON}$		195		$\mu\text{s}$
	$V_{CC} = 5.0\text{ V}; V_{IN} = 1.8\text{ V}$			180		
	$V_{CC} = 3.3\text{ V}; V_{IN} = 12\text{ V}$			280		
	$V_{CC} = 5.0\text{ V}; V_{IN} = 12\text{ V}$			265		
Output Turn-off Delay	$V_{CC} = 3.3\text{ V}; V_{IN} = 1.8\text{ V}$	$T_{OFF}$		4.1		$\mu\text{s}$
	$V_{CC} = 5.0\text{ V}; V_{IN} = 1.8\text{ V}$			3.5		
	$V_{CC} = 3.3\text{ V}; V_{IN} = 12\text{ V}$			1.4		
	$V_{CC} = 5.0\text{ V}; V_{IN} = 12\text{ V}$			0.8		
Power Good Turn-on Time	$V_{CC} = 3.3\text{ V}; V_{IN} = 1.8\text{ V}$	$T_{PG,ON}$		1.71		ms
	$V_{CC} = 5.0\text{ V}; V_{IN} = 1.8\text{ V}$			1.08		
	$V_{CC} = 3.3\text{ V}; V_{IN} = 12\text{ V}$			2.15		
	$V_{CC} = 5.0\text{ V}; V_{IN} = 12\text{ V}$			1.35		
Power Good Turn-off Time	$V_{CC} = 3.3\text{ V}; V_{IN} = 1.8\text{ V}$	$T_{PG,OFF}$		28		ns
	$V_{CC} = 5.0\text{ V}; V_{IN} = 1.8\text{ V}$			21		
	$V_{CC} = 3.3\text{ V}; V_{IN} = 12\text{ V}$			28		
	$V_{CC} = 5.0\text{ V}; V_{IN} = 12\text{ V}$			21		

15. See below figure for Test Circuit and Timing Diagram.

16. Tested with the following conditions:  $V_{TERM} = V_{CC}$ ;  $R_{PG} = 100\text{ k}\Omega$ ;  $R_L = 10\ \Omega$ ;  $C_L = 0.1\ \mu\text{F}$ .

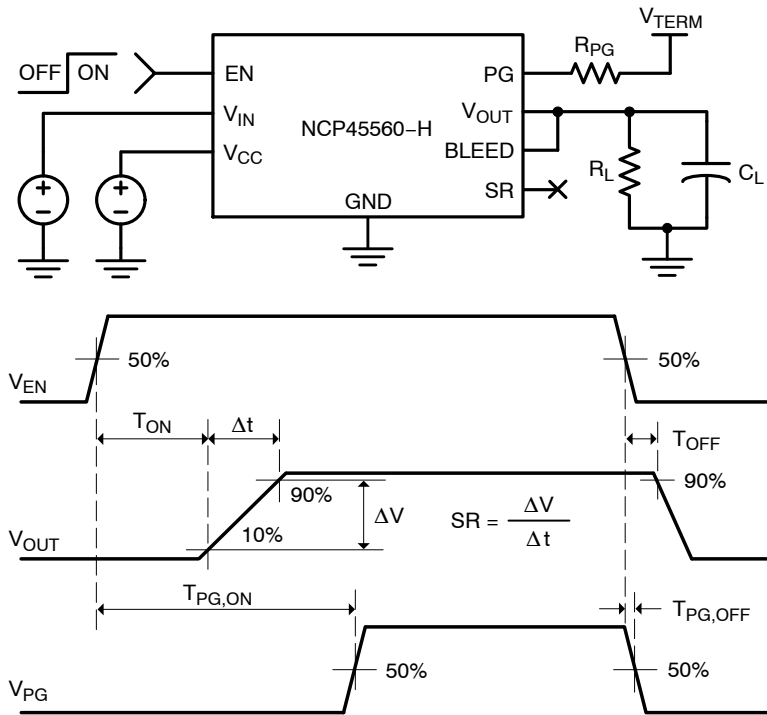

**Figure 2. Switching Characteristics Test Circuit and Timing Diagrams**

# NCP45560

## TYPICAL CHARACTERISTICS

( $T_J = 25^\circ\text{C}$  unless otherwise specified)

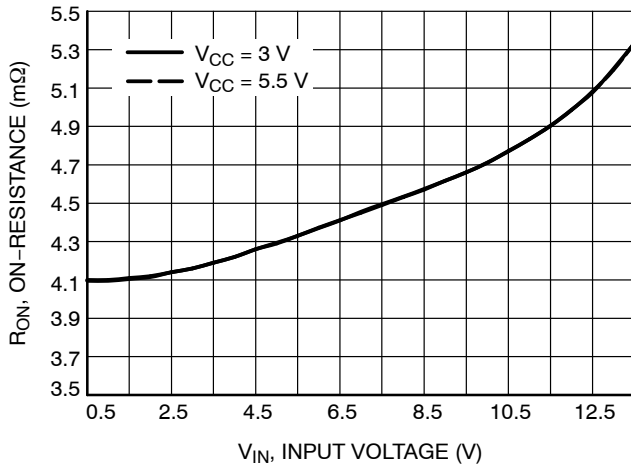

Figure 3. On-Resistance vs. Input Voltage

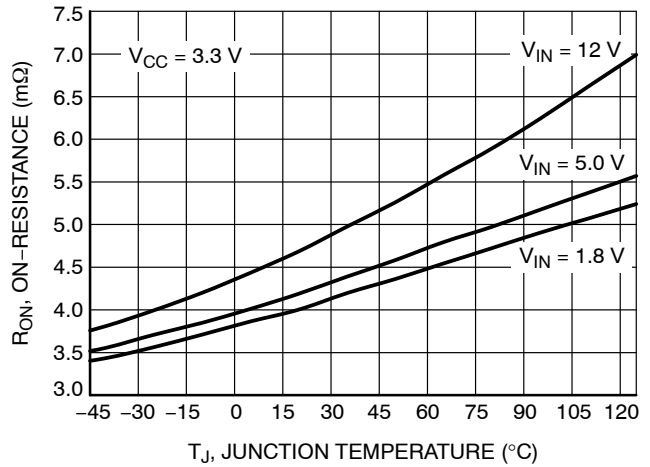

Figure 4. On-Resistance vs. Temperature

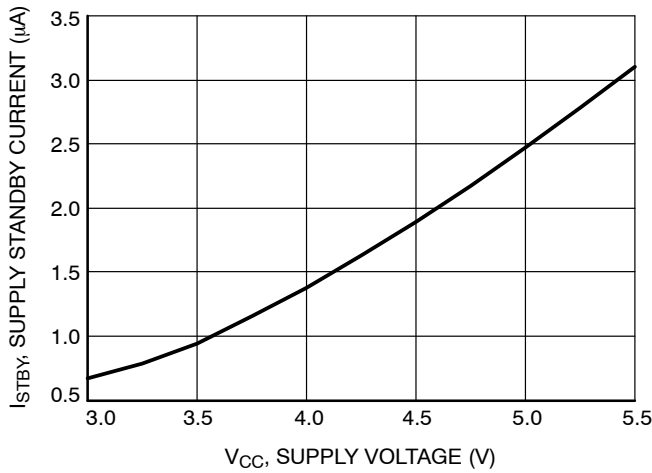

Figure 5. Supply Standby Current vs. Supply Voltage

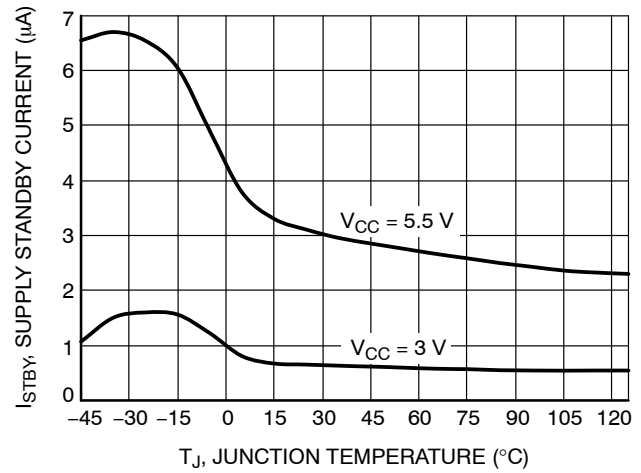

Figure 6. Supply Standby Current vs. Temperature

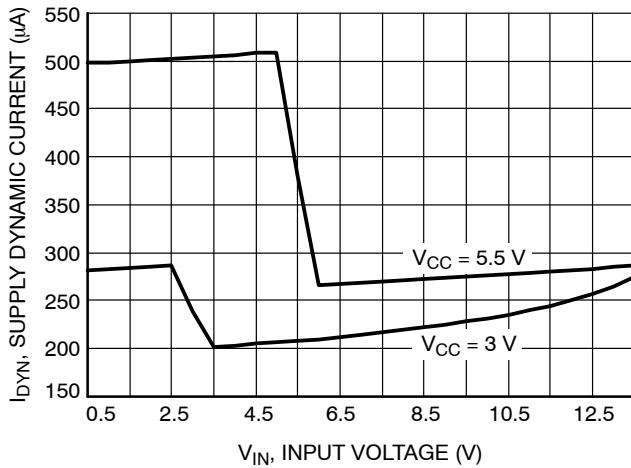

Figure 7. Supply Dynamic Current vs. Input Voltage

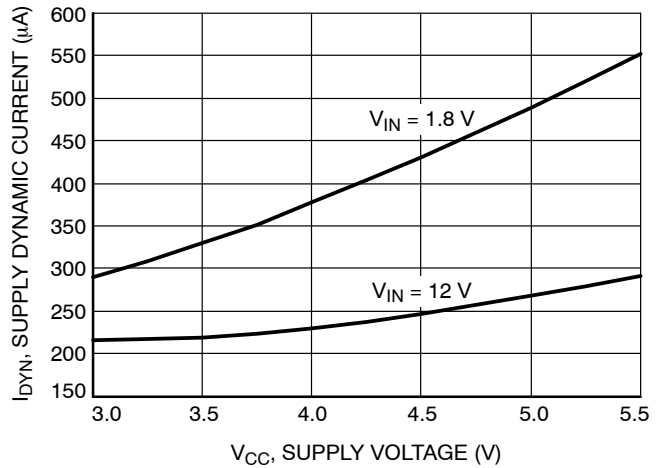

Figure 8. Supply Dynamic Current vs. Supply Voltage

TYPICAL CHARACTERISTICS

( $T_J = 25^\circ\text{C}$  unless otherwise specified)

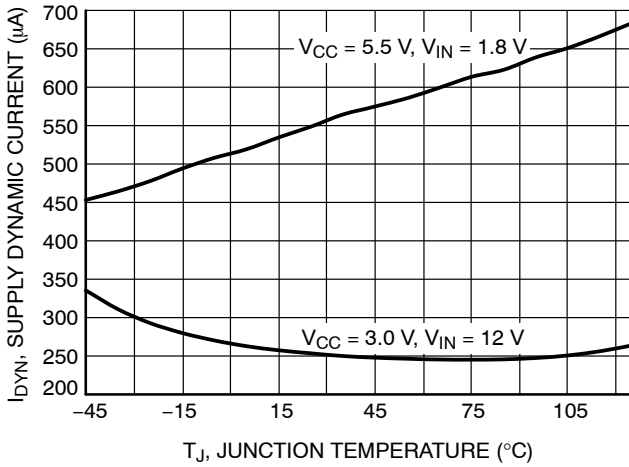

Figure 9. Supply Dynamic Current vs. Temperature

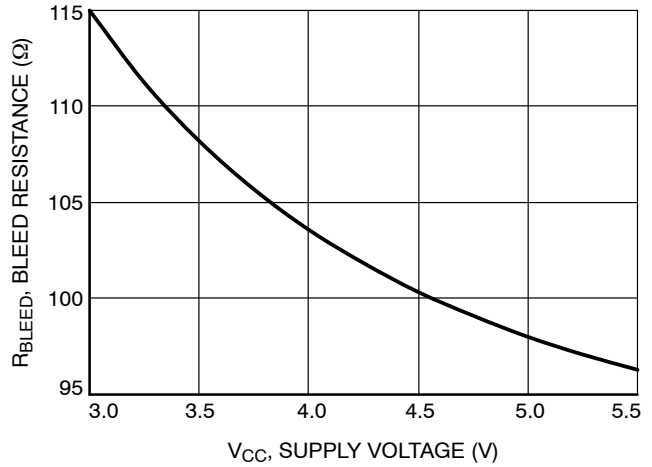

Figure 10. Bleed Resistance vs. Supply Voltage

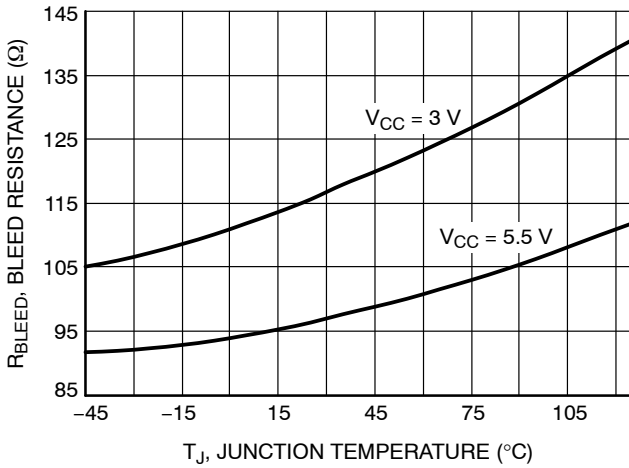

Figure 11. Bleed Resistance vs. Temperature

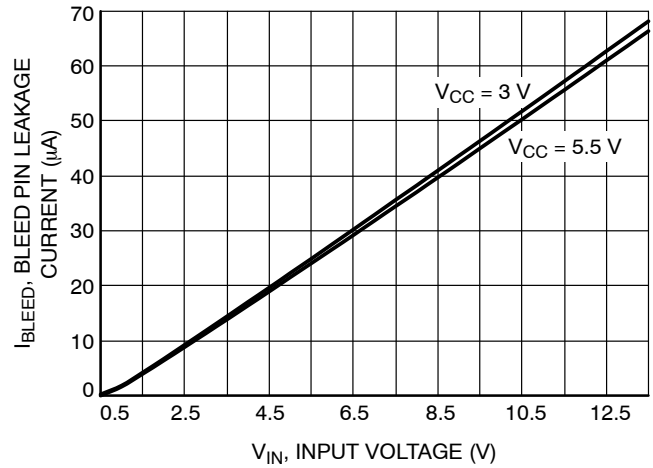

Figure 12. Bleed Pin Leakage Current vs. Input Voltage

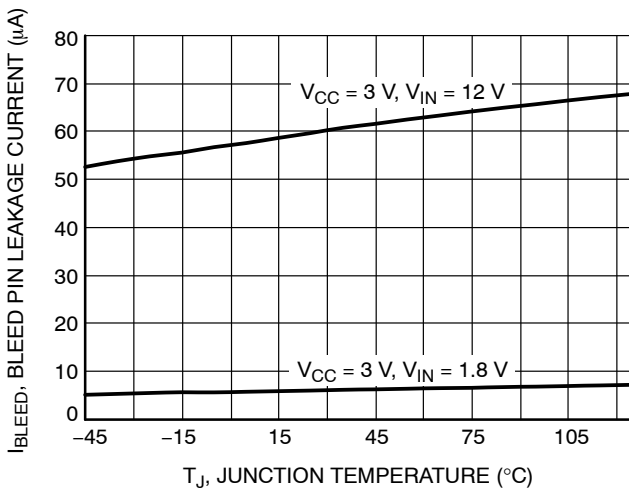

Figure 13. Bleed Pin Leakage Current vs. Temperature

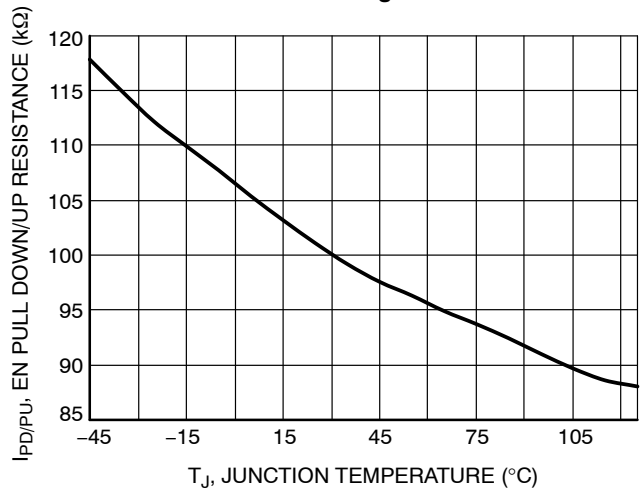

Figure 14. EN Pull Down/Up Resistance vs. Temperature

TYPICAL CHARACTERISTICS

( $T_J = 25^\circ\text{C}$  unless otherwise specified)

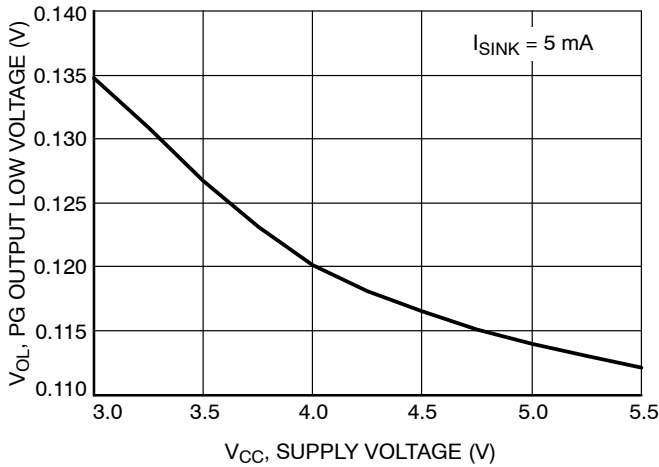

Figure 15. PG Output Low Voltage vs. Supply Voltage

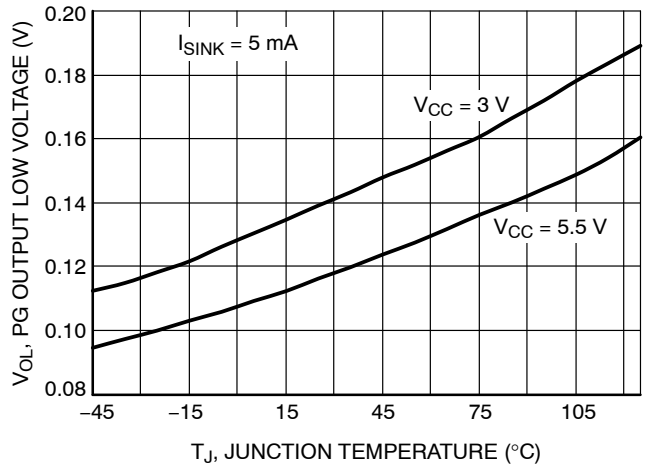

Figure 16. PG Output Low Voltage vs. Temperature

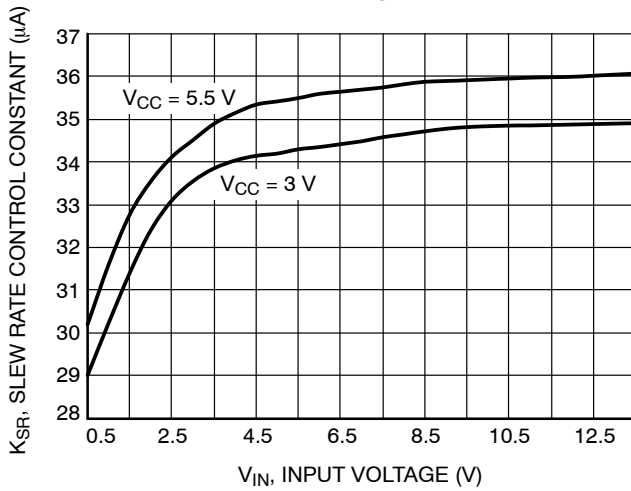

Figure 17. Slew Rate Control Constant vs. Input Voltage

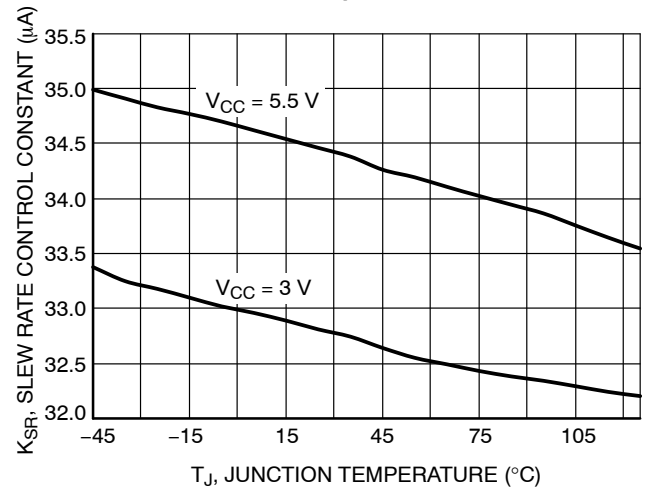

Figure 18. Slew Rate Control Constant vs. Temperature

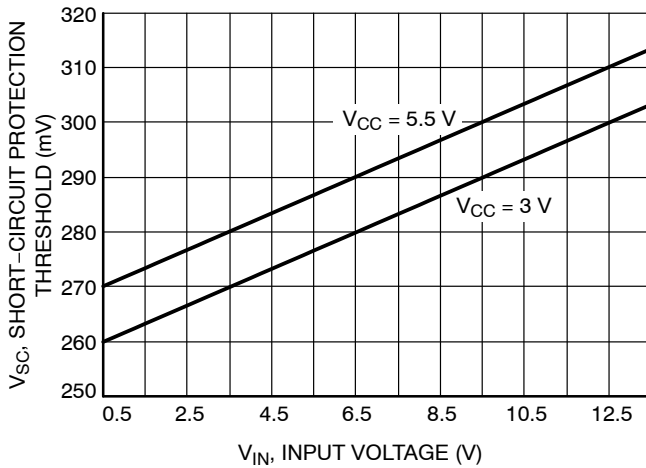

Figure 19. Short-Circuit Protection Threshold vs. Input Voltage

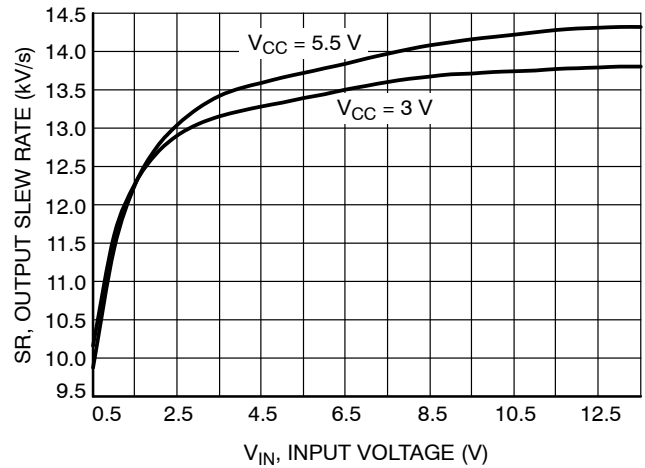

Figure 20. Output Slew Rate vs. Input Voltage

# NCP45560

## TYPICAL CHARACTERISTICS

( $T_J = 25^\circ\text{C}$  unless otherwise specified)

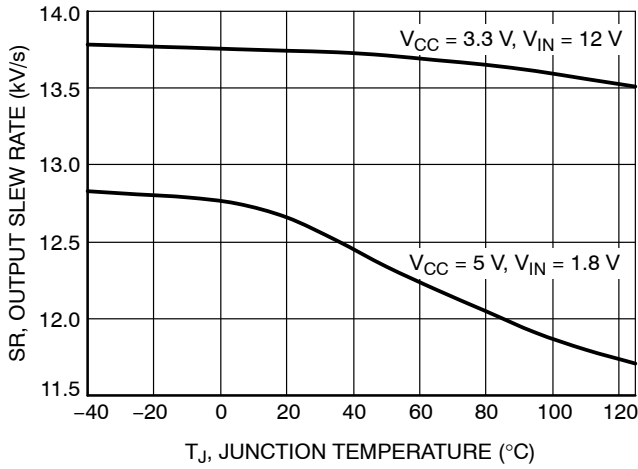

Figure 21. Output Slew Rate vs. Temperature

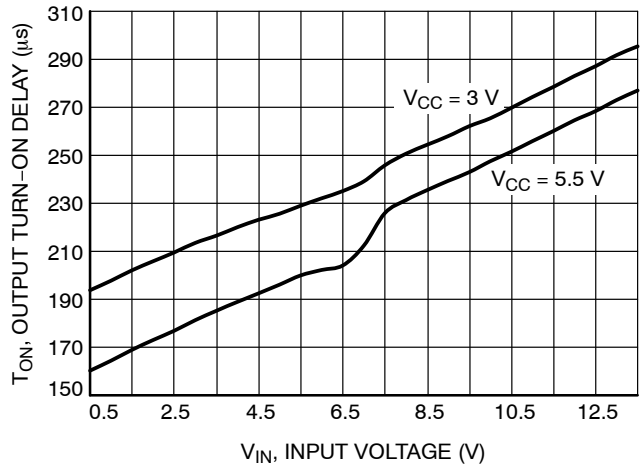

Figure 22. Output Turn-on Delay vs. Input Voltage

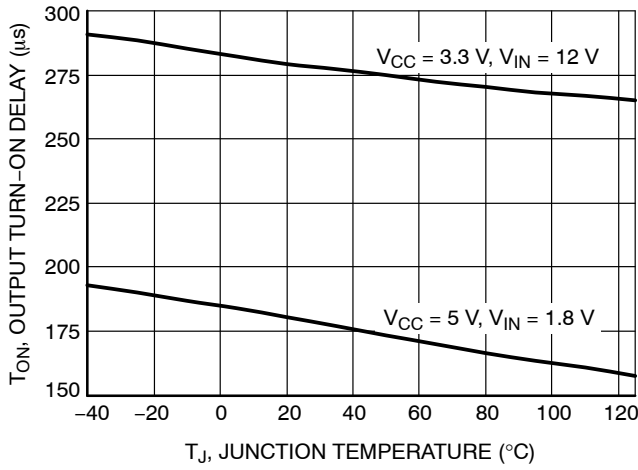

Figure 23. Output Turn-on Delay vs. Temperature

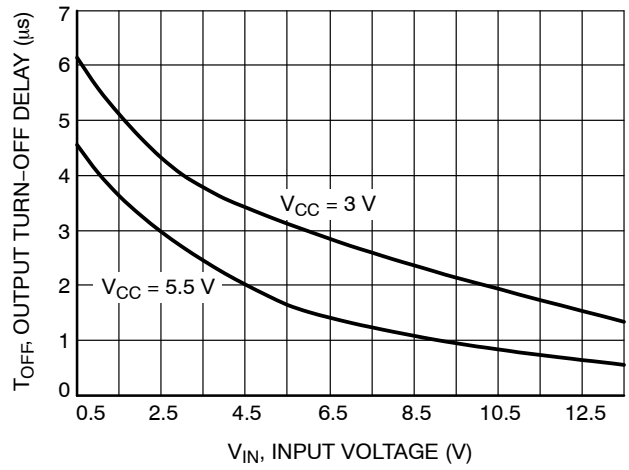

Figure 24. Output Turn-off Delay vs. Input Voltage

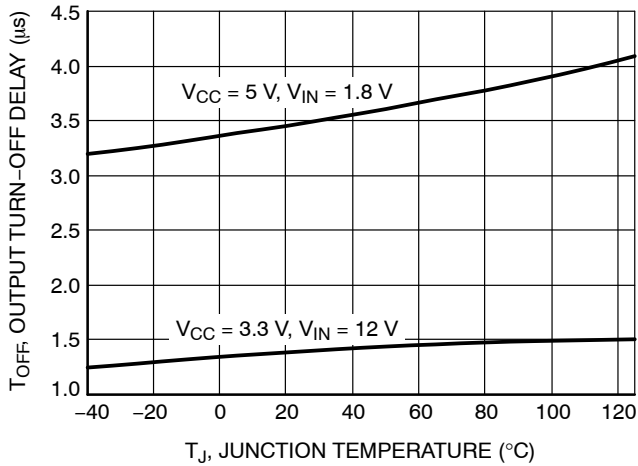

Figure 25. Output Turn-off Delay vs. Temperature

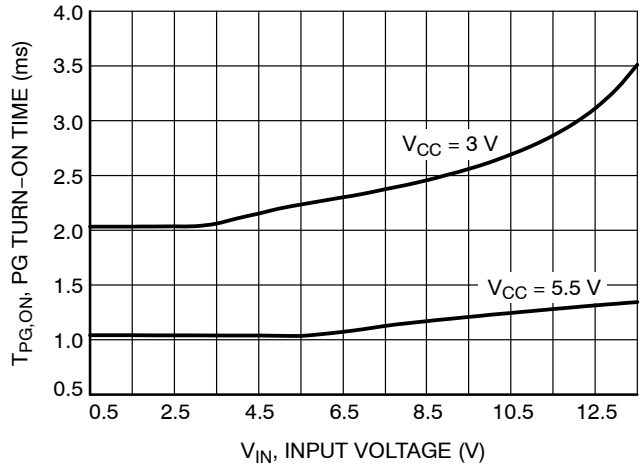

Figure 26. Power Good Turn-on Time vs. Input Voltage



# NCP45560

## TYPICAL CHARACTERISTICS

( $T_J = 25^\circ\text{C}$  unless otherwise specified)

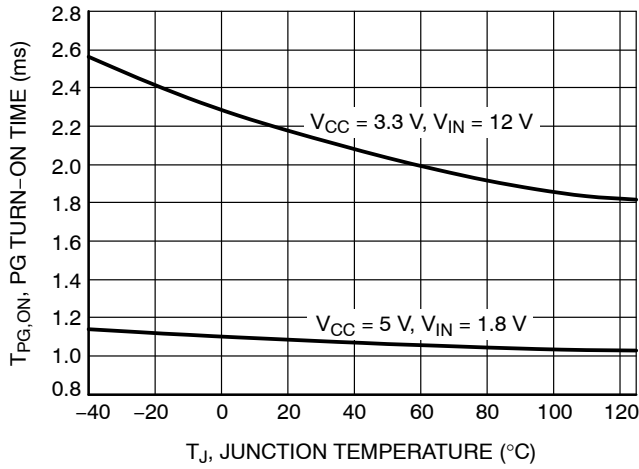

Figure 27. Power Good Turn-on Time vs. Temperature

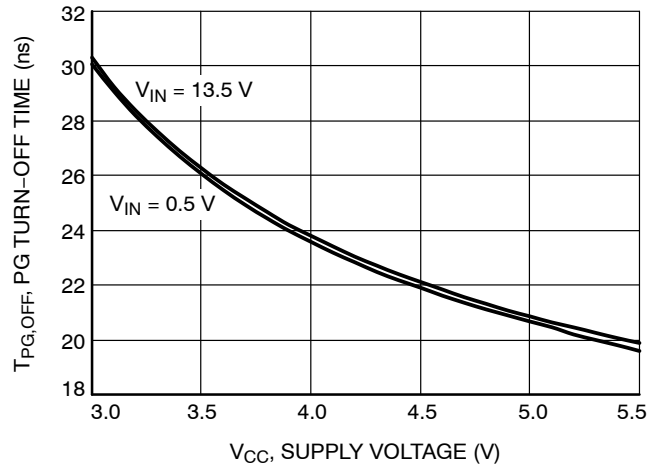

Figure 28. Power Good Turn-off Time vs. Supply Voltage

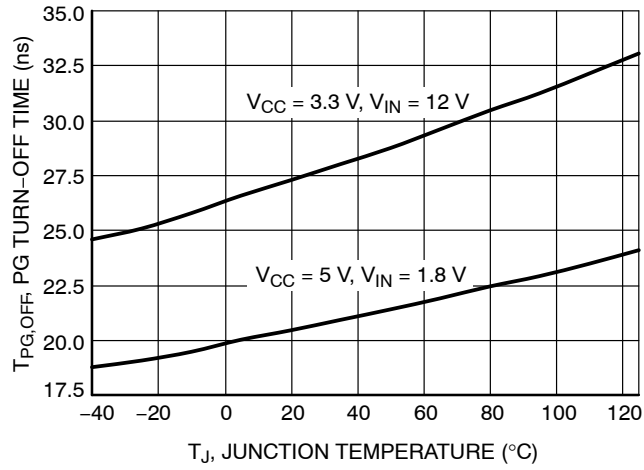

Figure 29. Power Good Turn-off Time vs. Temperature

APPLICATIONS INFORMATION

**Enable Control**

The NCP45560 has two part numbers, NCP45560–H and NCP45560–L, that only differ in the polarity of the enable control.

The NCP45560–H device allows for enabling the MOSFET in an active–high configuration. When the  $V_{CC}$  supply pin has an adequate voltage applied and the EN pin is at a logic high level, the MOSFET will be enabled. Similarly, when the EN pin is at a logic low level, the MOSFET will be disabled. An internal pull down resistor to ground on the EN pin ensures that the MOSFET will be disabled when not being driven.

The NCP45560–L device allows for enabling the MOSFET in an active–low configuration. When the  $V_{CC}$  supply pin has an adequate voltage applied and the EN pin is at a logic low level, the MOSFET will be enabled. Similarly, when the EN pin is at a logic high level, the MOSFET will be disabled. An internal pull up resistor to  $V_{CC}$  on the EN pin ensures that the MOSFET will be disabled when not being driven.

**Power Sequencing**

The NCP45560 devices will function with any power sequence, but the output turn–on delay performance may vary from what is specified. To achieve the specified performance, there are two recommended power sequences:

1.  $V_{CC} \rightarrow V_{IN} \rightarrow V_{EN}$
2.  $V_{IN} \rightarrow V_{CC} \rightarrow V_{EN}$

$V_{CC}$  must be at 2 V or higher when EN is asserted to ensure that the enable is latched properly for correct operation. If EN comes up before  $V_{CC}$  reaches 2 V, then the EN may not take effect.

**Load Bleed (Quick Discharge)**

The NCP45560 devices have an internal bleed resistor,  $R_{BLEED}$ , which is used to bleed the charge off of the load to ground after the MOSFET has been disabled. In series with the bleed resistor is a bleed switch that is enabled whenever the MOSFET is disabled. The MOSFET and the bleed switch are never concurrently active.

It is required that the BLEED pin be connected to  $V_{OUT}$  either directly (as shown in Figure 31) or through an external resistor,  $R_{EXT}$  (as shown in Figure 30).  $R_{EXT}$  should not exceed 1 k $\Omega$  and can be used to increase the total bleed resistance.

Care must be taken to ensure that the power dissipated across  $R_{BLEED}$  is kept at a safe level. The maximum continuous power that can be dissipated across  $R_{BLEED}$  is 0.4 W.  $R_{EXT}$  can be used to decrease the amount of power dissipated across  $R_{BLEED}$ .

**Power Good**

The NCP45560 devices have a power good output (PG) that can be used to indicate when the gate of the MOSFET is fully charged. The PG pin is an active–high, open–drain output that requires an external pull up resistor,  $R_{PG}$ , greater

than or equal to 1 k $\Omega$  to an external voltage source,  $V_{TERM}$ , compatible with input levels of other devices connected to this pin (as shown in Figures 30 and 31).

The power good output can be used as the enable signal for other active–high devices in the system (as shown in Figure 32). This allows for guaranteed by design power sequencing and reduces the number of enable signals needed from the system controller. If the power good feature is not used in the application, the PG pin should be tied to GND.

**Slew Rate Control**

The NCP45560 devices are equipped with controlled output slew rate which provides soft start functionality. This limits the inrush current caused by capacitor charging and enables these devices to be used in hot swap applications.

The slew rate can be decreased with an external capacitor added between the SR pin and ground (as shown in Figures 30 and 31). With an external capacitor present, the slew rate can be determined by the following equation:

$$\text{Slew Rate} = \frac{K_{SR}}{C_{SR}} \text{ [V/s]} \quad (\text{eq. 1})$$

where  $K_{SR}$  is the specified slew rate control constant, found in Table 4, and  $C_{SR}$  is the slew rate control capacitor added between the SR pin and ground. The slew rate of the device will always be the lower of the default slew rate and the adjusted slew rate. Therefore, if the  $C_{SR}$  is not large enough to decrease the slew rate more than the specified default value, the slew rate of the device will be the default value. The SR pin can be left floating if the slew rate does not need to be decreased.

**Short–Circuit Protection**

The NCP45560 devices are equipped with short–circuit protection that is used to help protect the part and the system from a sudden high–current event, such as the output,  $V_{OUT}$ , being shorted to ground. This circuitry is only active when the gate of the MOSFET is fully charged.

Once active, the circuitry monitors the difference in the voltage on the  $V_{IN}$  pin and the voltage on the BLEED pin. In order for the  $V_{OUT}$  voltage to be monitored through the BLEED pin, it is required that the BLEED pin be connected to  $V_{OUT}$  either directly (as shown in Figure 31) or through a resistor,  $R_{EXT}$  (as shown in Figure 30), which should not exceed 1 k $\Omega$ . With the BLEED pin connected to  $V_{OUT}$ , the short–circuit protection is able to monitor the voltage drop across the MOSFET.

If the voltage drop across the MOSFET is greater than or equal to the short–circuit protection threshold voltage, the MOSFET is immediately turned off and the load bleed is activated. The part remains latched in this off state until EN is toggled or  $V_{CC}$  supply voltage is cycled, at which point the MOSFET will be turned on in a controlled fashion with the normal output turn–on delay and slew rate. The current through the MOSFET that will cause a short–circuit event

can be calculated by dividing the short-circuit protection threshold by the expected on-resistance of the MOSFET.

**Thermal Shutdown**

The thermal shutdown of the NCP45560 devices protects the part from internally or externally generated excessive temperatures. This circuitry is disabled when EN is not active to reduce standby current. When an over-temperature condition is detected, the MOSFET is immediately turned off and the load bleed is activated.

The part comes out of thermal shutdown when the junction temperature decreases to a safe operating temperature as dictated by the thermal hysteresis. Upon exiting a thermal shutdown state, and if EN remains active, the MOSFET will be turned on in a controlled fashion with the normal output turn-on delay and slew rate.

**Undervoltage Lockout**

The undervoltage lockout of the NCP45560 devices turns the MOSFET off and activates the load bleed when the input voltage, V<sub>IN</sub>, is less than or equal to the undervoltage lockout threshold. This circuitry is disabled when EN is not active to reduce standby current.

If the V<sub>IN</sub> voltage rises above the undervoltage lockout threshold, and EN remains active, the MOSFET will be turned on in a controlled fashion with the normal output turn-on delay and slew rate.

**Capacitive Load**

The peak in-rush current associated with the initial charging of the application load capacitance needs to stay below the specified I<sub>MAX</sub>. CL (capacitive load) should be less than C<sub>max</sub> as defined by the following equation:

$$C_{max} = \frac{I_{max}}{SR_{typ}} \quad (eq. 2)$$

Where I<sub>MAX</sub> is the maximum load current, and SR<sub>typ</sub> is the typical default slew rate when no external load capacitor is added to the SR pin.

**OFF to ON Transition Energy Dissipation**

The energy dissipation due to load current traveling from V<sub>IN</sub> to V<sub>OUT</sub> is very low during steady state operation due

to the low R<sub>ON</sub>. When the EN signal is asserted high, the load switch transitions from an OFF state to an ON state. During this time, the resistance from V<sub>IN</sub> to V<sub>OUT</sub> transitions from high impedance to R<sub>ON</sub>, and additional energy is dissipated in the device for a short period of time. The worst case energy dissipated during the OFF to ON transition can be approximated by the following equation:

$$E = 0.5 \cdot V_{IN} \cdot (I_{INRUSH} + 0.8 \cdot I_{LOAD}) \cdot dt \quad (eq. 3)$$

Where V<sub>IN</sub> is the voltage on the V<sub>IN</sub> pin, I<sub>INRUSH</sub> is the inrush current caused by capacitive loading on V<sub>OUT</sub>, and dt is the time it takes V<sub>OUT</sub> to rise from 0 V to V<sub>IN</sub>. I<sub>INRUSH</sub> can be calculated using the following equation:

$$I_{INRUSH} = \frac{dv}{dt} \cdot C_L \quad (eq. 4)$$

Where dv/dt is the programmed slew rate, and C<sub>L</sub> is the capacitive loading on V<sub>OUT</sub>. To prevent thermal lockout or damage to the device, the energy dissipated during the OFF to ON transition should be limited to E<sub>TRANS</sub> listed in operating ranges table.

**ecoSWITCH LAYOUT GUIDELINES**

**Electrical Layout Considerations**

Correct physical PCB layout is important for proper low noise accurate operation of all ecoSWITCH products.

**Power Planes:** The ecoSWITCH is optimized for extremely low Ron resistance, however, improper PCB layout can substantially increase source to load series resistance by adding PCB board parasitic resistance. Solid connections to the VIN and VOUT pins of the ecoSWITCH to copper planes should be used to achieve low series resistance and good thermal dissipation. The ecoSWITCH requires ample heat dissipation for correct thermal lockout operation. The internal FET dissipates load condition dependent amounts of power in the milliseconds following the rising edge of enable, and providing good thermal conduction from the packaging to the board is critical. Direct coupling of VIN to VOUT should be avoided, as this will adversely affect slew rates.

# NCP45560

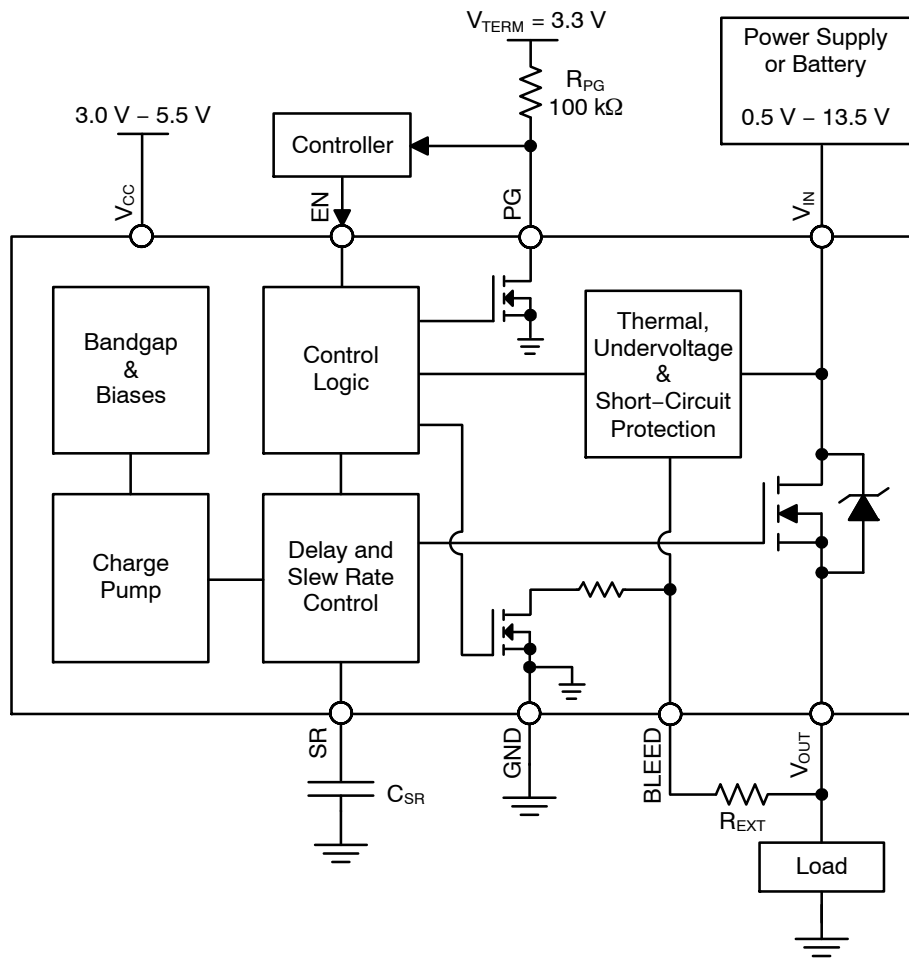

Figure 30. Typical Application Diagram – Load Switch

# NCP45560

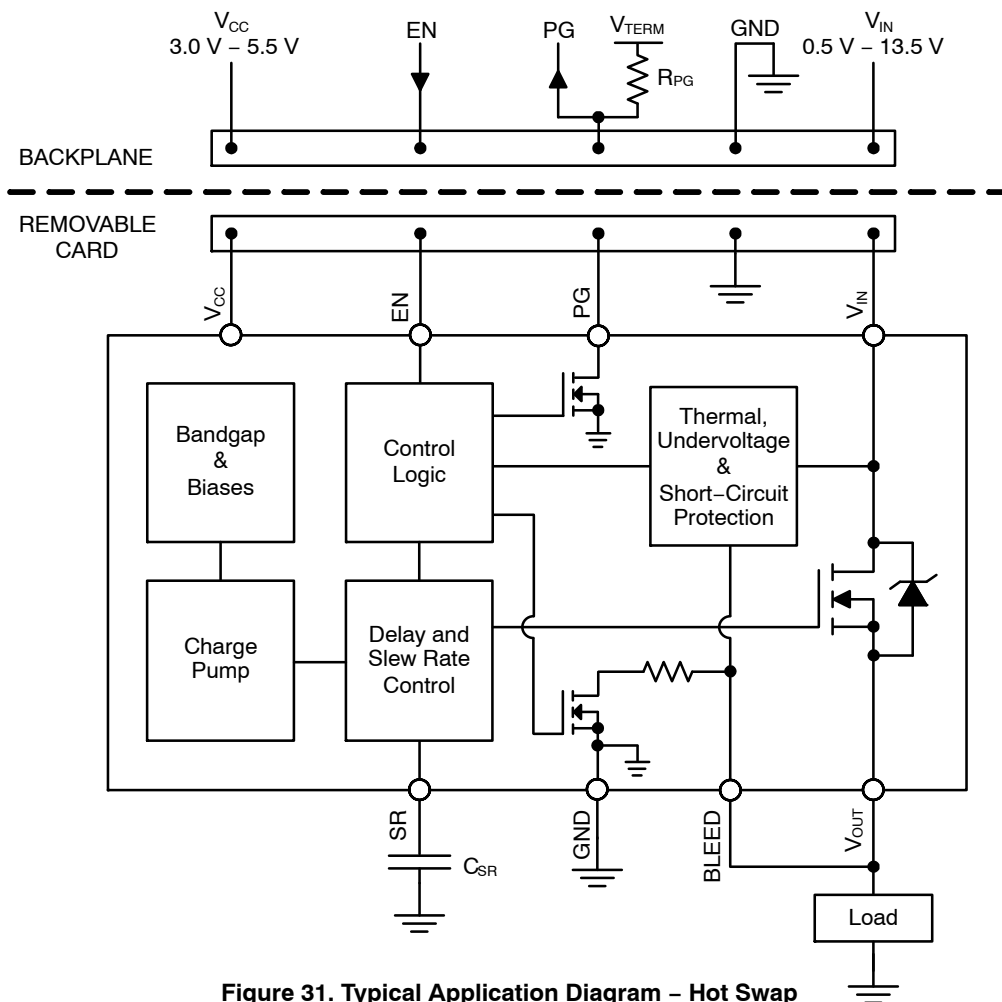

Figure 31. Typical Application Diagram - Hot Swap

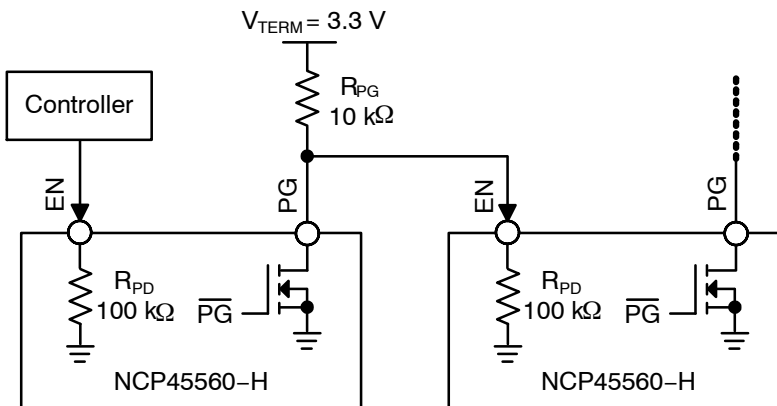

Figure 32. Simplified Application Diagram - Power Sequencing with PG Output

## ORDERING INFORMATION

Device	EN Polarity	Package	Shipping†
NCP45560IMNTWG-H	Active-High	DFN12 (Pb-Free)	3000 / Tape & Reel
NCP45560IMNTWG-L	Active-Low		

†For information on tape and reel specifications, including part orientation and tape sizes, please refer to our Tape and Reel Packaging Specifications Brochure, BRD8011/D.

ecoSWITCH is a trademark of Semiconductor Components Industries, LLC (SCILLC).

# MECHANICAL CASE OUTLINE

## PACKAGE DIMENSIONS

ON Semiconductor®

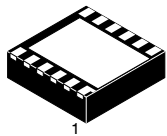

SCALE 4:1

DFN12 3x3, 0.5P  
CASE 506CD  
ISSUE A

DATE 18 FEB 2014

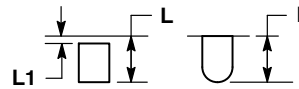
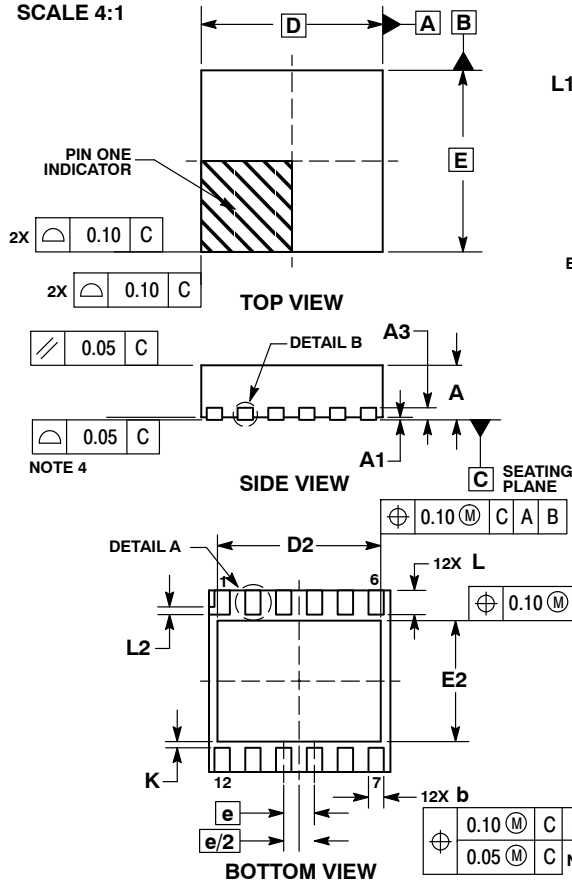

DETAIL A  
ALTERNATE  
CONSTRUCTIONS

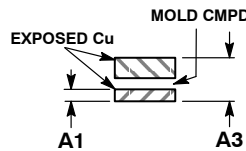

DETAIL B  
ALTERNATE  
CONSTRUCTION

NOTES:

1. DIMENSIONING AND TOLERANCING PER ASME Y14.5M, 1994.
2. CONTROLLING DIMENSION: MILLIMETERS.
3. DIMENSION b APPLIES TO PLATED TERMINAL AND IS MEASURED BETWEEN 0.15 AND 0.30 MM FROM TERMINAL TIP.
4. COPLANARITY APPLIES TO THE EXPOSED PAD AS WELL AS THE TERMINALS.

DIM	MILLIMETERS	
	MIN	MAX
A	0.80	1.00
A1	0.00	0.05
A3	0.20 REF	
b	0.20	0.30
D	3.00 BSC	
D2	2.60	2.80
E	3.00 BSC	
E2	1.90	2.10
e	0.50 BSC	
L	0.20	0.40
L1	---	0.15
L2	0.10 REF	
K	0.15 MIN	

GENERIC MARKING DIAGRAM\*

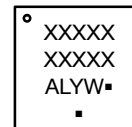

- A = Assembly Location
- L = Wafer Lot
- Y = Year
- W = Work Week
- = Pb-Free Package

(Note: Microdot may be in either location)

\*This information is generic. Please refer to device data sheet for actual part marking. Pb-Free indicator, "G" or microdot "▪", may or may not be present.

RECOMMENDED SOLDERING FOOTPRINT\*

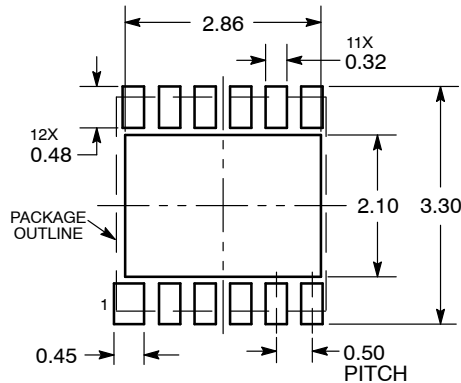

\*For additional information on our Pb-Free strategy and soldering details, please download the ON Semiconductor Soldering and Mounting Techniques Reference Manual, SOLDERRM/D.

DOCUMENT NUMBER:	98AON67174E	Electronic versions are uncontrolled except when accessed directly from the Document Repository. Printed versions are uncontrolled except when stamped "CONTROLLED COPY" in red.
DESCRIPTION:	DFN12 3X3, 0.5P	PAGE 1 OF 1

ON Semiconductor and ON are trademarks of Semiconductor Components Industries, LLC dba ON Semiconductor or its subsidiaries in the United States and/or other countries. ON Semiconductor reserves the right to make changes without further notice to any products herein. ON Semiconductor makes no warranty, representation or guarantee regarding the suitability of its products for any particular purpose, nor does ON Semiconductor assume any liability arising out of the application or use of any product or circuit, and specifically disclaims any and all liability, including without limitation special, consequential or incidental damages. ON Semiconductor does not convey any license under its patent rights nor the rights of others.

**onsemi**, **Onsemi**, and other names, marks, and brands are registered and/or common law trademarks of Semiconductor Components Industries, LLC dba "**onsemi**" or its affiliates and/or subsidiaries in the United States and/or other countries. **onsemi** owns the rights to a number of patents, trademarks, copyrights, trade secrets, and other intellectual property. A listing of **onsemi**'s product/patent coverage may be accessed at [www.onsemi.com/site/pdf/Patent-Marking.pdf](http://www.onsemi.com/site/pdf/Patent-Marking.pdf). **onsemi** reserves the right to make changes at any time to any products or information herein, without notice. The information herein is provided "as-is" and **onsemi** makes no warranty, representation or guarantee regarding the accuracy of the information, product features, availability, functionality, or suitability of its products for any particular purpose, nor does **onsemi** assume any liability arising out of the application or use of any product or circuit, and specifically disclaims any and all liability, including without limitation special, consequential or incidental damages. Buyer is responsible for its products and applications using **onsemi** products, including compliance with all laws, regulations and safety requirements or standards, regardless of any support or applications information provided by **onsemi**. "Typical" parameters which may be provided in **onsemi** data sheets and/or specifications can and do vary in different applications and actual performance may vary over time. All operating parameters, including "Typicals" must be validated for each customer application by customer's technical experts. **onsemi** does not convey any license under any of its intellectual property rights nor the rights of others. **onsemi** products are not designed, intended, or authorized for use as a critical component in life support systems or any FDA Class 3 medical devices or medical devices with a same or similar classification in a foreign jurisdiction or any devices intended for implantation in the human body. Should Buyer purchase or use **onsemi** products for any such unintended or unauthorized application, Buyer shall indemnify and hold **onsemi** and its officers, employees, subsidiaries, affiliates, and distributors harmless against all claims, costs, damages, and expenses, and reasonable attorney fees arising out of, directly or indirectly, any claim of personal injury or death associated with such unintended or unauthorized use, even if such claim alleges that **onsemi** was negligent regarding the design or manufacture of the part. **onsemi** is an Equal Opportunity/Affirmative Action Employer. This literature is subject to all applicable copyright laws and is not for resale in any manner.

## ADDITIONAL INFORMATION

### TECHNICAL PUBLICATIONS:

Technical Library: [www.onsemi.com/design/resources/technical-documentation](http://www.onsemi.com/design/resources/technical-documentation)  
onsemi Website: [www.onsemi.com](http://www.onsemi.com)

### ONLINE SUPPORT: [www.onsemi.com/support](http://www.onsemi.com/support)

For additional information, please contact your local Sales Representative at [www.onsemi.com/support/sales](http://www.onsemi.com/support/sales)