

3-Phase Gate Driver, 60 V

NCD83591

Overview

The NCD83591 is an easy to use, multi-purpose 3-phase gate-driver optimized for low BOM cost. The wide operating voltage range make this device ideal for industrial and commercial applications from 5 V (min) up to 60 V (max).

Features

- Operation from 5 V to 60 V Supply Voltage with Tolerance from 4 V to 70 V
- Constant Current Drive of Power FET, Configurable from 5 mA to 250 mA (16 Settings by Input Level to VDRV Pin)
- Internally Generated Gate Drive Supply Voltages
- Tolerant to -12 V DC for High Side Gate and Source Output Pins
- Gate Sensing for Cross Conduction Protection and Optimized Dead Time
- Embedded High GBW General Purpose Amplifier (Intended for Current Sensing and Externally Configurable)
- Embedded Charge Pump Function Allowing DC Static Drive
- Strong Hold-off Current Preventing Self-turn-on
- Internal Gate Pull-down to GND during Loss of VDD (Core) Power
- Under Voltage Lock Out on VM, VGL, and VGH-VM with Optional Trip Levels
- 5 V/3.3 V Compatible 6 Input Control Plus Enable
- Individual Six Gate Control Mode with Separate Pin to Override and Drive All 6 Gate Outputs Low
- 4 kV HBM and 1 kV CDM ESD Protection
- This is a Pb-Free Device

Applications

- Power Tools
- Industrial Actuators and Cobots
- Automated Guided Robots
- Light Mobility (E-Bikes, E-scooters, Hoverboards)

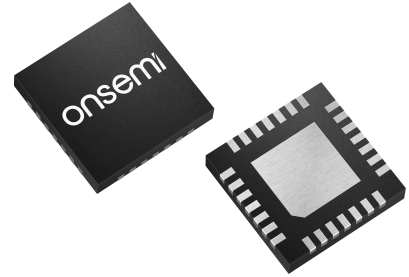

QFN28 4x4, 0.4P
CASE 485GF

MARKING DIAGRAM

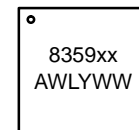

8359xx = Specific Device Code
A = Assembly Location
WL = Wafer Lot
Y = Year
WW = Work Week

ORDERING INFORMATION

See detailed ordering and shipping information on page 9 of this data sheet.

NCD83591

APPLICATION CIRCUIT

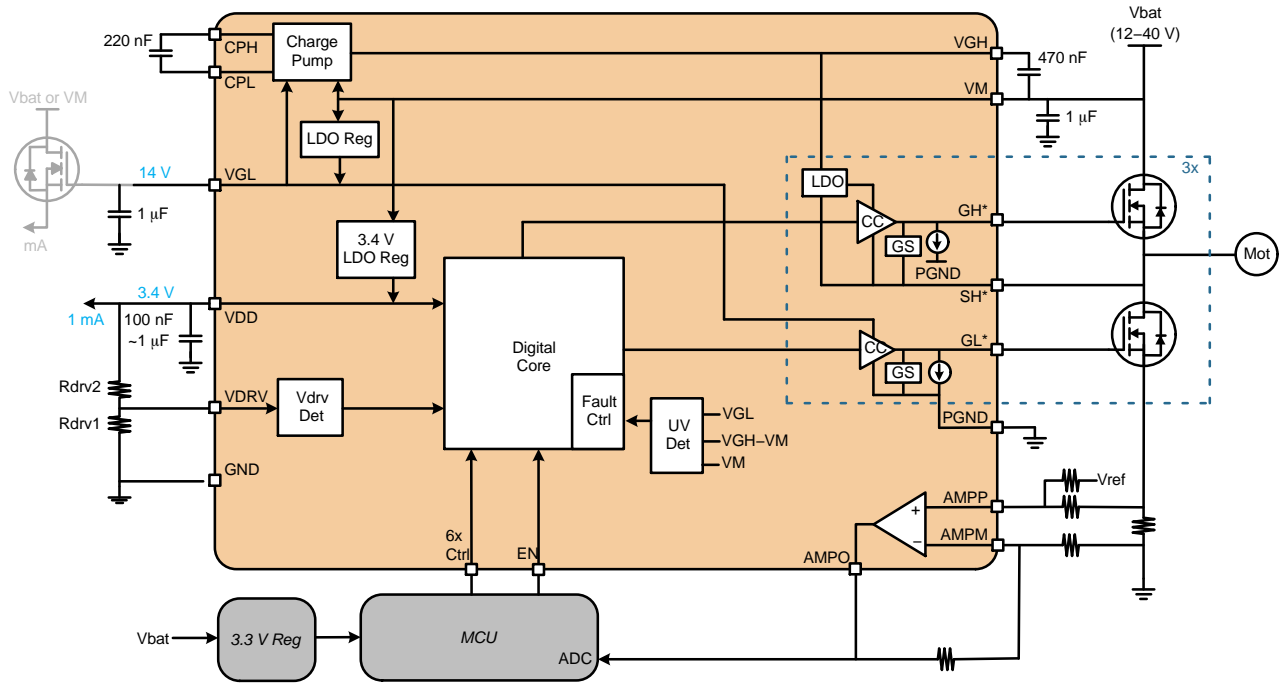

Figure 1. Typical Application Diagram

PIN ASSIGNMENT

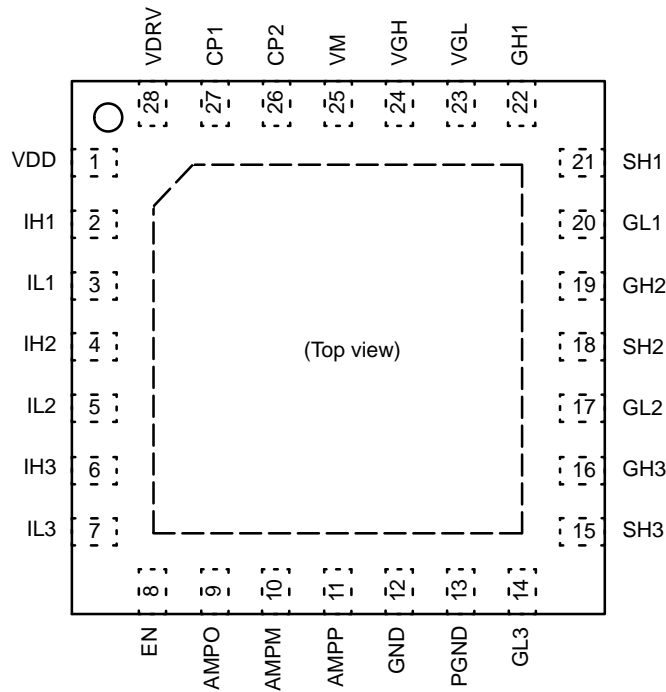

Figure 2. NCD83591 Pinout

PIN ASSIGNMENTS & PIN DESCRIPTION

Pin #	Name	Description
1	VDD	Internal 3 V regulator bypass pin
2	IH1	Active high control for GH1
3	IL1	Active low control for GL1
4	IH2	Active high control for GH2
5	IL2	Active low control for GL2
6	IH3	Active high control for GH3
7	IL3	Active low control for GL3
8	EN	Active high control to enable driver outputs
9	AMPO	Configurable AMP output
10	AMPM	Configurable AMP negative input
11	AMPP	Configurable AMP positive input
12	GND	General ground
13	PGND	Power stage ground
14	GL3	Gate driver output for phase 3 low side external FET
15	SH3	Connection for motor phase 3
16	GH3	Gate driver output for phase 3 high side external FET
17	GL2	Gate driver output for phase 2 low side external FET
18	SH2	Connection for motor phase 2
19	GH2	Gate driver output for phase 2 high side external FET
20	GL1	Gate driver output for phase 1 low side external FET
21	SH1	Connection for motor phase 1
22	GH1	Gate driver output for phase 1 high side external FET
23	VGL	Internal 14 V regulator bypass pin
24	VGH	Output of charge pump and storage capacitor pin
25	VM	Motor voltage
26	CP2	Pumping node of charge pump
27	CP1	Switching node of charge pump
28	VDRV	Voltage used to control driver currents

ABSOLUTE MAXIMUM RATINGS (Voltages are referenced to GND unless otherwise noted)

Parameter	Pins	Ratings	Unit
Motor Supply Voltage	VM	-0.3 to 70	V
Gate Low Voltage	VGL	-0.3 to 20	V
Gate High Voltage	VGH	-0.3 to 90	V
Gate High Voltage Relative to VM	VGH – VM	-0.3 to 20	V
High Side Output	GH[1–3]	-12 to VGH + 0.3	V
Voltage between High Side Output and Motor Phase	GH[1–3] – SH[1–3]	-0.3 to 20	V
Motor Phase	SH[1–3]	-12 to VGH + 0.3	V
Low-side Output	GL[1–3] (relative to PGND)	-0.3 to VGL + 0.3	V
Logic Power Supply	VDD	-0.3 to 3.65	V
Digital Inputs	IH[1–3], IL[1–3], EN	-0.3 to 6	V
Analog Inputs/Outputs	AMPM, AMPP, AMPO, VDRV	-0.3 to VDD + 0.3	V

NCD83591

ABSOLUTE MAXIMUM RATINGS (Voltages are referenced to GND unless otherwise noted) (continued)

Parameter	Pins	Ratings	Unit
Charge Pump – Switching Node	CP1	-0.3 to VGL + 0.3	V
Charge Pump – Pumping Node	CP2	VM – 1 to VGH + 1	V
Charge Pump – Pumping Node Peak Input Current	CP2	-0.1 to 0.1	A
Storage Temperature		-55 to 150	°C
Junction Temperature		-40 to 150	°C

Stresses exceeding those listed in the Maximum Ratings table may damage the device. If any of these limits are exceeded, device functionality should not be assumed, damage may occur and reliability may be affected.

ESD RATINGS

Parameter	Ratings	Unit
Human Body Model (HBM)	±4000	V
Charged Device Model (CDM)	±1000	V

THERMAL INFORMATION

Parameter	Pins	Ratings	Unit
Theta-JA	Junction Ambient Thermal Resistance	62.5	°C/W
Psi-JB	Junction to Board Characterization Parameter	23.0	°C/W
Psi-JT	Junction to Top Characterization Parameter	4.2	°C/W

ELECTRICAL CHARACTERISTICS

(Valid at a junction temperature range from -40°C to 150°C, for VM supply Voltage 8.0 V ≤ VM ≤ 60 V unless otherwise specified. Typical values at 25°C and VM = 24 V unless specified otherwise.)

Parameter	Symbol	Conditions	Min	Typ	Max	Unit
VM Supply Voltage Range		Normal mode	5	24	60 (Note 1)	V
		Full logic functionality, driver stage off	4	-	70	V
VM Supply Current		EN = H (outputs not toggling), AMP used	-	4.6	5.7	mA
VM Supply Current		EN = H (outputs not toggling), AMP disabled by tying AMPP = VDD and AMPM = GND	-	4.1	5.2	mA

INTERNAL REGULATOR (VDD)

VDD Output Voltage			3.2	3.4	3.6	V
VDD External Load Current			-	-	1	mA

GATE VOLTAGES (CP1, VGH, VGL)

VGL Output Voltage		$I_{VGL} < 15 \text{ mA}, V_M > 15 \text{ V}$	13	14	15	V
VGL Output Voltage		$I_{VGL} < 15 \text{ mA}, V_M < 15 \text{ V}$	$V_M - 0.43$	-	-	V
VGL Current Limit			-	23	30	mA
Charge Pump Frequency			-	125	-	kHz
Charge Pump Output Voltage		$VGH - V_M, I_{VGH} < 7.5 \text{ mA}$	$VGL - 1.2$	$VGL - 0.75$	-	V

GATE DRIVERS (GH[1-3], GL[1-3])

GL[n], GH[n] Discharge Current to PGND	IDIS	"L" level	-	2 x ICHG	-	mA
--	------	-----------	---	----------	---	----

NCD83591

ELECTRICAL CHARACTERISTICS (continued)

(Valid at a junction temperature range from -40°C to 150°C , for VM supply Voltage $8.0\text{ V} \leq \text{VM} \leq 60\text{ V}$ unless otherwise specified. Typical values at 25°C and $\text{VM} = 24\text{ V}$ unless specified otherwise.)

Parameter	Symbol	Conditions	Min	Typ	Max	Unit
GATE DRIVERS (GH[1–3], GL[1–3])						
GL[n], GH[n] Charge Current	ICHG	"H" level, VDRVcode = 15	–	5	–	mA
		"H" level, VDRVcode = 14	–	10	–	mA
		"H" level, VDRVcode = 13	–	15	–	mA
		"H" level, VDRVcode = 12	–	20	–	mA
		"H" level, VDRVcode = 11	–	25	–	mA
		"H" level, VDRVcode = 10	–	30	–	mA
		"H" level, VDRVcode = 9	–	40	–	mA
		"H" level, VDRVcode = 8	–	50	–	mA
		"H" level, VDRVcode = 7	–	60	–	mA
		"H" level, VDRVcode = 6	–	75	–	mA
		"H" level, VDRVcode = 5	–	100	–	mA
		"H" level, VDRVcode = 4	–	125	–	mA
		"H" level, VDRVcode = 3	–	150	–	mA
		"H" level, VDRVcode = 2	–	175	–	mA
		"H" level, VDRVcode = 1	–	200	–	mA
"H" level, VDRVcode = 0	–	250	–	mA		
Gate Sense Low Threshold	VGSL	GL[1–3], GH[1–3] – SH[1–3]	–	1	–	V
		Hysteresis	–	1	–	V
Cross Conduction Protection Time	t_{xcp}	See Figure 3 No Load on GL[1–3] or GH[1–3]	–	200	–	ns
Input to Output Propagation Delay	t_{prop}	See Figure 3 No Load on GL[1–3] or GH[1–3]	–	–	100	ns
Pull-down Current (GH*, GL*)	IPD	VM = 5 V VDD = 0 V GH* = GL* = 2 V Applied per Table 1	500	900	1300	μA

CONFIGURABLE AMP (AMPP, AMPM, AMPO)

AMPP, AMPM Input Current	AMPP_CUR	INPUT = 0–VDD	–1	–	1	μA
	AMPM_CUR	INPUT = 0–VDD	–1	–	1	μA
AMPO Full Scale Range_1	FS1	RL = 10 k Ω	0.1	–	VDD – 0.15	V
UGBW_1		RL = 10 k Ω to GND, CL = 60 pF At FS1	10	–	–	MHz
Open Loop Gain_1		At FS1	90	–	–	dB
AMPO Full Scale Range_2	FS2	RL = 10 k Ω	0.05	–	VDD – 0.1	V
UGBW_2		RL = 10 k Ω to GND, CL = 60 pF At FS2	8	–	–	MHz
Open Loop Gain_2		At FS2	75	–	–	dB
Slew Rate		Unity Gain, RL = 10 k Ω , CL = 60 pF	10	–	–	V/ μs
Input Offset Voltage		RL = 10 k Ω	–	± 0.55 (Note 3)	± 4.0	mV
Common Mode Input Voltage			0	–	VDD – 1.2	V

NCD83591

ELECTRICAL CHARACTERISTICS (continued)

(Valid at a junction temperature range from -40°C to 150°C , for VM supply Voltage $8.0\text{ V} \leq \text{VM} \leq 60\text{ V}$ unless otherwise specified. Typical values at 25°C and $\text{VM} = 24\text{ V}$ unless specified otherwise.)

Parameter	Symbol	Conditions	Min	Typ	Max	Unit
-----------	--------	------------	-----	-----	-----	------

DIGITAL INPUTS (IH[1-3], IL[1-3], EN)

High-level Input Voltage		V _{IH} (Note 2)	2.1	–	5.5	V
Low-level Input Voltage		V _{IL} (Note 2)	0	–	0.7	V
Pull-down Current			30	–	100	μA

PROTECTION LEVELS

VM Under-voltage Lock Out	V _{MUV}		4.3	4.5	4.7	V
		Hysteresis	–	0.2	–	V
VGL Under-voltage Lock Out	V _{GLUV}	VVGL Falling NCD83591MNTXG NCD83591MNATXG	3.9 7.7	4.1 8.0	4.3 8.3	V
		Hysteresis NCD83591MNTXG NCD83591MNATXG	– –	0.20 0.27	– –	V
VGH Under-voltage Lock Out	V _{GHUV}	VGH – VM Falling NCD83591MNTXG NCD83591MNATXG	2.8 7.4	3.0 8.0	3.25 8.4	V
		Hysteresis NCD83591MNTXG NCD83591MNATXG	– –	0.20 0.30	– –	V
Under-voltage Lock Out De-glitch Filter	UVFILT	V _{MUV} , V _{GLUV} , V _{GHUV}	–	200	–	μs
VDD POR Lock Out	V _{DDUV}		1.55	2.26	2.75	V
		Hysteresis	–	0.15	–	V

Product parametric performance is indicated in the Electrical Characteristics for the listed test conditions, unless otherwise noted. Product performance may not be indicated by the Electrical Characteristics if operated under different conditions.

1. Power dissipation and temp must be accounted for when connecting to voltages > 12 V.
2. Digital inputs are 5 V tolerant.
3. Typical value is a 1 sigma number.

DETAILED FUNCTIONAL DESCRIPTION

Chip Activation, System States and Shutdown

Table 1 shows the operation modes and associated pin states.

Table 1. OPERATION MODES

State	POR (Note 4)	UV_VM (Note 3)	UV_VGL (Note 2, 3)	UV_VGH (Note 3)	Digital Inputs			Driver Outputs (Note 2)		CP1 (Note 2)
					EN	IH*	IL* (Note 1)	GH*	GL*	
POR	H	X	X	X	X	X	X	L-PD	L-PD	L
UV	L	H	X	X	X	X	X	L-PD	L-PD	L
UV	L	X	H	X	X	X	X	L-PD	L-PD	L
Charge	L	L	L	H	X	X	X	L-PD	L-PD	Active
Disable	L	L	L	L	L	X	X	L-PD	L-PD	Active
Drive	L	L	L	L	H	L	L	L	H	Active
Freewheel	L	L	L	L	H	L	H	L	L	Active
Freewheel	L	L	L	L	H	H	L	L	L	Active
Drive	L	L	L	L	H	H	H	H	L	Active

1. IL* inputs are active low.
2. Active means outputs are following the behavior of normal operation. L-PD means that pull down currents (IPD) may be active if 3 V core supply is not sufficient to drive L.
3. H = Under Voltage condition (supply voltage is less than detection levels & filter timer has expired).
4. H = Reset state (VDD voltage is less than detection level).

System Power Supplies (VM, VDD, VGL, VGH)

Internal Core Regulator (VDD)

The internal regulator is supplied by VM and regulates to 3.4 V at VDD. VDD needs to be bypassed to GND for stability. It is not intended for any external loads (other than Rdrv1/Rdrv2), but can support a load up to 1 mA, if necessary.

Gate Voltage Regulator (VGL)

The gate voltage regulator is supplied by VM and regulates to 14 V at VGL.

VGL provides the drive voltage for the low-side drivers GL[1-3] directly and for the high side drivers GH[1-3] through the charge pump circuitry. The output is current limited. The output at VGL must be bypassed with a capacitor to GND which should be at least 10 times the maximum gate capacitance of the power FETs.

Charge Pump (VGH)

An on-chip charge pump provides the gate voltage for the high-side drivers.

Motor Control Inputs (IL[1-3], IH[1-3], EN)

Once the NCD83591 is in Drive or Freewheel mode, a microcontroller can facilitate motor control via the inputs IL[1-3], IH[1-3] and EN. All pins are 5 V/3.3 V compatible. All pins have pull-down currents, so when left floating will be pulled low and cause the outputs to follow the appropriate row in Table 1.

Gate Drive (GH[1-3], GL[1-3], SH[1-3])

The gate drive circuit of the NCD83591 includes 3 half-bridge drivers which control six external N-Channel FETs. The high side gate drivers GH[1-3] switch their gate connection either to VGH or the respective phase connection SH[1-3]. The low-side gate drivers GL[1-3] are switched from VGL to PGND.

Gate Drive Source/Sink Current Selection

The gate drive currents are programmable to 16 different values as defined in the Electrical Characteristics Table. The VDRVcode is achieved by configuring Rdrv1 and Rdrv2 with standard 5% resistors as described in the Application Diagram with the values that match the desired gate drive currents from Table 2.

Table 2. VDRVcode DESCRIPTION

VDRVcode	Rdrv1	Rdrv2	ICHG	IDIS
15	82k	12k	5	10
14	68k	15k	10	20
13	51k	16k	15	30
12	47k	20k	20	40
11	33k	18k	25	50
10	47k	33k	30	60
9	27k	24k	40	80
8	24k	27k	50	100
7	36k	51k	60	120
6	20k	36k	75	150
5	24k	56k	100	200
4	18k	56k	125	250
3	13k	56k	150	300
2	12k	82k	175	350
1	6.8k	91k	200	400
0	0	Open	250	500

Selected Isrc currents will typically be between 1 mA/nC and 2 mA/nC of FET total gate charge (Qg) to achieve a power stage switching net (SH[1–3]) transition times of about 50 ns. General procedure to selecting a drive current is to start low and increase until ringing on the gate nets or switching nets becomes noticeable, but is still acceptable.

Gate Sensing and Cross Conduction Protection

The gate sensing and cross conduction protection features of the NCD83591 eliminate the need for any minimum dead time control by the gate driver, or even any dead times programmed into the MCU. Corresponding IH[n] and IL[n] pins can be pulsed at the same time and can even be shorted together for motor control methods that do not require tri-stating the power stage (drive 3 mode).

The cross conduction protection feature requires one side of a given phase to be proven to be in an “off” state before the other side is allowed to be turned on to prevent any cross conduction or shoot-through current in the power stage. The diagram in Figure 3 demonstrates this behavior.

In addition, if a given side is currently in an “off” state and something external pulls it to an “on” state, the part forces the opposite side to an “off” state to again prevent shoot-through currents. Sensing a FET is in an “off” state is done through the gate sensing circuit.

The MCU can still force a controlled dead time if desired. This is considered a Drive 6 configuration where each IL[n] and IH[n] pin is driven independently, and the MCU forces a dead time between when low and high sides are active. However, the cross conduction protection will still take precedence if this MCU programmed dead time becomes too short.

The gate sensing provides yet another feature of the part in which a much stronger sinking driver is activated about 50 ns after a gate is sensed to be low. This results in a low hold-off driver resistance to further prevent self turn-on when the SH[n] net is transitioning fast.

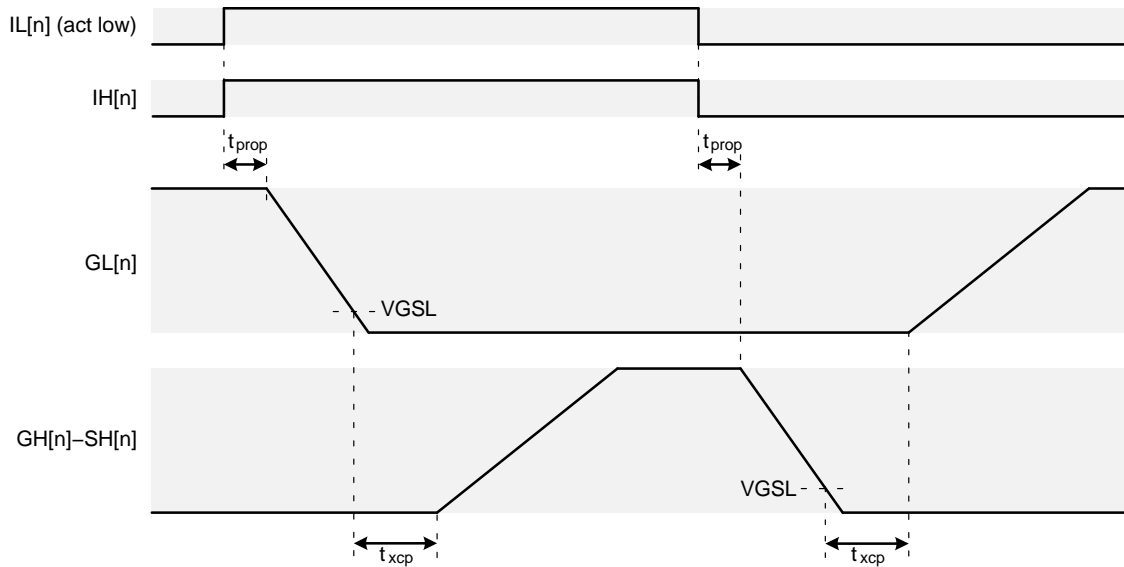

Figure 3. Gate Sensing and Dead Time Diagram

Configurable Amp (AMPP, AMPN, AMPO)

An externally configurable high performance general purpose amplifier is included. It is intended for current sensing as per the Application Diagram, but can be used in

any configuration that follows the constraints outlined in the Electrical Characteristics table.

If the configurable amp is not intended to be used, about 0.5 mA of current can be saved by tying AMPP = VDD and AMPM = GND.

NCD83591

ORDERING INFORMATION

Device Order Number	Marking	UVOL	Package Type	Shipping†
1NCD83591MNTXG	8359A	4.1 V (VGL) 3.0 V (VGH-VM)	QFN28 (Pb-Free)	4000 / Tape & Reel
1NCD83591MNATXG	8359AA	8.0 V	QFN28 (Pb-Free)	4000 / Tape & Reel

†For information on tape and reel specifications, including part orientation and tape sizes, please refer to our Tape and Reel Packaging Specifications Brochure, BRD8011/D.

MECHANICAL CASE OUTLINE

PACKAGE DIMENSIONS

ON Semiconductor®

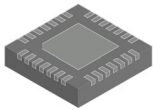

QFN28 4x4, 0.4P
CASE 485GF
ISSUE O

DATE 03 NOV 2020

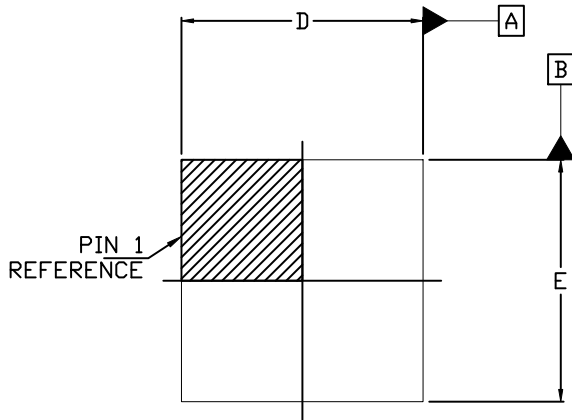

TOP VIEW

- NOTES:
1. DIMENSIONING AND TOLERANCING PER ASME Y14.5M, 2009.
 2. CONTROLLING DIMENSION: MILLIMETERS
 3. DIMENSION *b* APPLIES TO PLATED TERMINALS AND IS MEASURED BETWEEN 0.15 AND 0.30MM FROM THE TERMINAL TIP.
 4. COPLANARITY APPLIES TO THE TERMINALS.
 5. POSITIONAL TOLERANCE APPLIES TO ALL TERMINALS.
 6. PACKAGE DIMENSIONS EXCLUSIVE OF BURRS AND MOLD FLASH.

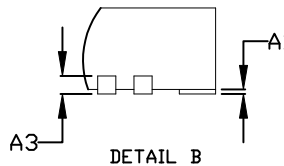

DETAIL B

DIM	MILLIMETERS		
	MIN.	NOM.	MAX.
A	0.80	0.90	1.00
A1	0.00	---	0.05
A3	0.20 REF		
b	0.15	0.20	0.25
D	3.90	4.00	4.10
D2	2.10	2.20	2.30
E	3.90	4.00	4.10
E2	2.10	2.20	2.30
e	0.40 BSC		
K	0.50 REF		
L	0.30	0.40	0.50

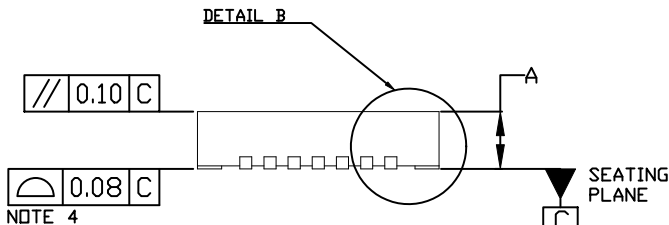

SIDE VIEW

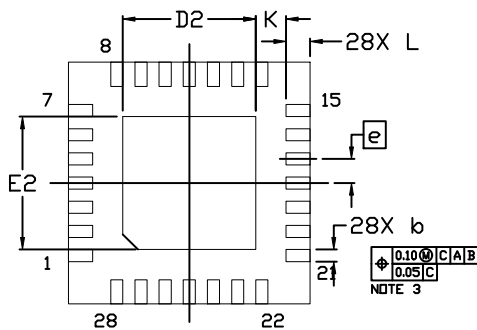

BOTTOM VIEW

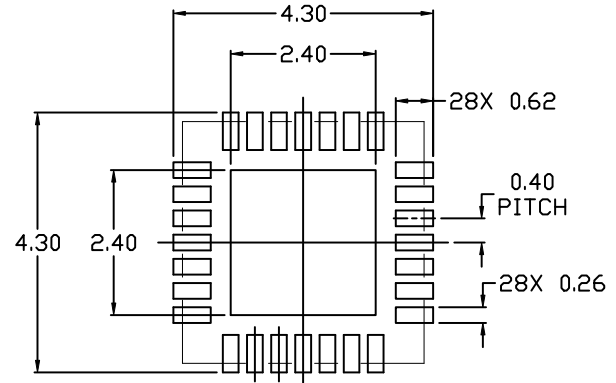

RECOMMENDED MOUNTING FOOTPRINT*

* For additional information on our Pb-Free strategy and soldering details, please download the ON Semiconductor Soldering and Mounting Techniques Reference Manual, SOLDERRM/D.

GENERIC MARKING DIAGRAM*

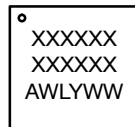

XXXX = Specific Device Code
A = Assembly Location
WL = Wafer Lot
Y = Year
WW = Work Week

*This information is generic. Please refer to device data sheet for actual part marking. Pb-Free indicator, "G" or microdot "•", may or may not be present. Some products may not follow the Generic Marking.

DOCUMENT NUMBER:	98AON27471H	Electronic versions are uncontrolled except when accessed directly from the Document Repository. Printed versions are uncontrolled except when stamped "CONTROLLED COPY" in red.
DESCRIPTION:	QFN28 4x4, 0.4P	PAGE 1 OF 1

ON Semiconductor and are trademarks of Semiconductor Components Industries, LLC dba ON Semiconductor or its subsidiaries in the United States and/or other countries. ON Semiconductor reserves the right to make changes without further notice to any products herein. ON Semiconductor makes no warranty, representation or guarantee regarding the suitability of its products for any particular purpose, nor does ON Semiconductor assume any liability arising out of the application or use of any product or circuit, and specifically disclaims any and all liability, including without limitation special, consequential or incidental damages. ON Semiconductor does not convey any license under its patent rights nor the rights of others.

onsemi, **Onsemi**, and other names, marks, and brands are registered and/or common law trademarks of Semiconductor Components Industries, LLC dba "**onsemi**" or its affiliates and/or subsidiaries in the United States and/or other countries. **onsemi** owns the rights to a number of patents, trademarks, copyrights, trade secrets, and other intellectual property. A listing of **onsemi**'s product/patent coverage may be accessed at www.onsemi.com/site/pdf/Patent-Marking.pdf. **onsemi** reserves the right to make changes at any time to any products or information herein, without notice. The information herein is provided "as-is" and **onsemi** makes no warranty, representation or guarantee regarding the accuracy of the information, product features, availability, functionality, or suitability of its products for any particular purpose, nor does **onsemi** assume any liability arising out of the application or use of any product or circuit, and specifically disclaims any and all liability, including without limitation special, consequential or incidental damages. Buyer is responsible for its products and applications using **onsemi** products, including compliance with all laws, regulations and safety requirements or standards, regardless of any support or applications information provided by **onsemi**. "Typical" parameters which may be provided in **onsemi** data sheets and/or specifications can and do vary in different applications and actual performance may vary over time. All operating parameters, including "Typicals" must be validated for each customer application by customer's technical experts. **onsemi** does not convey any license under any of its intellectual property rights nor the rights of others. **onsemi** products are not designed, intended, or authorized for use as a critical component in life support systems or any FDA Class 3 medical devices or medical devices with a same or similar classification in a foreign jurisdiction or any devices intended for implantation in the human body. Should Buyer purchase or use **onsemi** products for any such unintended or unauthorized application, Buyer shall indemnify and hold **onsemi** and its officers, employees, subsidiaries, affiliates, and distributors harmless against all claims, costs, damages, and expenses, and reasonable attorney fees arising out of, directly or indirectly, any claim of personal injury or death associated with such unintended or unauthorized use, even if such claim alleges that **onsemi** was negligent regarding the design or manufacture of the part. **onsemi** is an Equal Opportunity/Affirmative Action Employer. This literature is subject to all applicable copyright laws and is not for resale in any manner.

ADDITIONAL INFORMATION

TECHNICAL PUBLICATIONS:

Technical Library: www.onsemi.com/design/resources/technical-documentation
onsemi Website: www.onsemi.com

ONLINE SUPPORT: www.onsemi.com/support

For additional information, please contact your local Sales Representative at www.onsemi.com/support/sales