

# TinyLogic UHS Buffer with Three-State Output

## NC7SZ125

### Description

The NC7SZ125 is a single buffer with three-state output from onsemi's Ultra-High Speed (UHS) of TinyLogic. The device is fabricated with advanced CMOS technology to achieve ultra high speed with high output drive while maintaining low static power dissipation over a very broad  $V_{CC}$  operating range. The device is specified to operate over the 1.65 V to 5.5 V range. The inputs and output are high impedance above ground when  $V_{CC}$  is 0 V. Inputs tolerate voltages up to 5.5 V independent of  $V_{CC}$  operating voltage. The output tolerates voltages above  $V_{CC}$  when in the 3-STATE condition.

### Features

- Ultra-High Speed:  $t_{PD} = 2.6$  ns (Typical) into 50 pF at 5 V  $V_{CC}$
- High Output Drive:  $\pm 24$  mA at 3 V  $V_{CC}$
- Broad  $V_{CC}$  Operating Range: 1.65 V to 5.5 V
- Matches Performance of LCX when Operated at 3.3 V  $V_{CC}$
- Power Down High-Impedance Inputs / Outputs
- Over-Voltage Tolerance Inputs Facilitate 5 V to 3 V Translation
- Proprietary Noise / EMI Reduction Circuitry
- Ultra-Small MicroPak™ Packages
- Space-Saving SOT23-5, SC-74A and SC-88A Packages
- These Devices are Pb-Free, Halogen Free/BFR Free and are RoHS Compliant

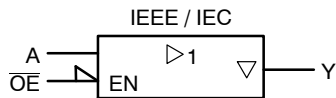
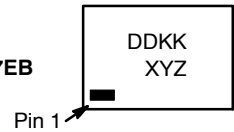

Figure 1. Logic Symbol

### MARKING DIAGRAMS



SIP6  
CASE 127EB



UDFN6  
CASE 517DP

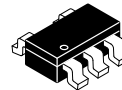
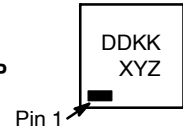

SC-74A  
CASE 318BQ

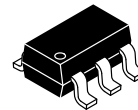
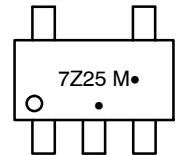

SOT23-5  
CASE 527AH

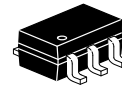
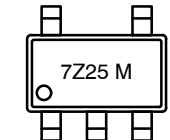

SC-88A  
CASE 419A-02

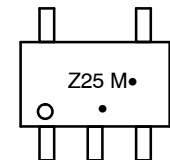

DD, 7Z25, Z25 = Specific Device Code  
 KK = 2-Digit Lot Run Traceability Code  
 XY = 2-Digit Date Code Format  
 Z = Assembly Plant Code  
 M = Date Code  
 • = Pb-Free Package  
 (Microdot may be in either location)

### ORDERING INFORMATION

See detailed ordering, marking and shipping information in the package dimensions section on page 6 of this data sheet.

# NC7SZ125

## Pin Configurations

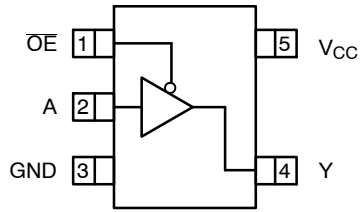

Figure 2. SOT23-5, SC-88A and SC-74A  
(Top View)

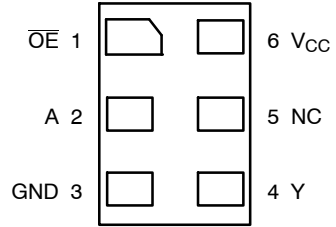

Figure 3. MicroPak (Top Through View)

### PIN DEFINITIONS

| Pin #<br>SOT23-5 /<br>SC-88A /<br>SC74A | Pin # MicroPak | Name            | Description    |
|-----------------------------------------|----------------|-----------------|----------------|
| 1                                       | 1              | $\overline{OE}$ | Input          |
| 2                                       | 2              | A               | Input          |
| 3                                       | 3              | GND             | Ground         |
| 4                                       | 4              | Y               | Output         |
| 5                                       | 6              | $V_{CC}$        | Supply Voltage |
|                                         | 5              | NC              | No Connect     |

### FUNCTION TABLE

| Inputs          |   | Output |
|-----------------|---|--------|
| $\overline{OE}$ | A | Y      |
| L               | L | L      |
| L               | H | H      |
| H               | X | Z      |

H = HIGH Logic Level  
 L = LOW Logic Level  
 X = HIGH or LOW Logic Level  
 Z = HIGH Impedance State

# NC7SZ125

## ABSOLUTE MAXIMUM RATINGS

| Symbol                              | Parameter                                         |                        | Min  | Max  | Unit |
|-------------------------------------|---------------------------------------------------|------------------------|------|------|------|
| V <sub>CC</sub>                     | Supply Voltage                                    |                        | -0.5 | 6.5  | V    |
| V <sub>IN</sub>                     | DC Input Voltage                                  |                        | -0.5 | 6.5  | V    |
| V <sub>OUT</sub>                    | DC Output Voltage                                 |                        | -0.5 | 6.5  | V    |
| I <sub>IK</sub>                     | DC Input Diode Current                            | V <sub>IN</sub> < 0 V  | -    | -50  | mA   |
| I <sub>OK</sub>                     | DC Output Diode Current                           | V <sub>OUT</sub> < 0 V | -    | -50  | mA   |
| I <sub>OUT</sub>                    | DC Output Current                                 |                        | -    | ±50  | mA   |
| I <sub>CC</sub> or I <sub>GND</sub> | DC V <sub>CC</sub> or Ground Current              |                        | -    | ±50  | mA   |
| T <sub>STG</sub>                    | Storage Temperature Range                         |                        | -65  | +150 | °C   |
| T <sub>J</sub>                      | Junction Temperature Under Bias                   |                        | -    | +150 | °C   |
| T <sub>L</sub>                      | Junction Lead Temperature (Soldering, 10 Seconds) |                        | -    | +260 | °C   |
| P <sub>D</sub>                      | Power Dissipation in Still Air                    | SC-74A / SOT23-5       | -    | 390  | mW   |
|                                     |                                                   | SC-88A                 | -    | 332  |      |
|                                     |                                                   | MicroPak-6             | -    | 812  |      |
|                                     |                                                   | MicroPak2™-6           | -    | 812  |      |
| ESD                                 | Human Body Model, JEDEC: JESD22-A114              |                        | -    | 4000 | V    |
|                                     | Charge Device Model, JEDEC: JESD22-C101           |                        | -    | 2000 |      |

Stresses exceeding those listed in the Maximum Ratings table may damage the device. If any of these limits are exceeded, device functionality should not be assumed, damage may occur and reliability may be affected.

## RECOMMENDED OPERATING CONDITIONS

| Symbol                          | Parameter                     | Conditions                             | Min  | Max             | Unit |
|---------------------------------|-------------------------------|----------------------------------------|------|-----------------|------|
| V <sub>CC</sub>                 | Supply Voltage Operating      |                                        | 1.65 | 5.50            | V    |
|                                 | Supply Voltage Data Retention |                                        | 1.50 | 5.50            |      |
| V <sub>IN</sub>                 | Input Voltage                 |                                        | 0    | 5.5             | V    |
| V <sub>OUT</sub>                | Output Voltage                | Active State                           | 0    | V <sub>CC</sub> | V    |
|                                 |                               | Three-State                            | 0    | 5.5             |      |
| T <sub>A</sub>                  | Operating Temperature         |                                        | -40  | +85             | °C   |
| t <sub>r</sub> , t <sub>f</sub> | Input Rise and Fall Times     | V <sub>CC</sub> at 1.8 V, 2.5 V ±0.2 V | 0    | 20              | ns/V |
|                                 |                               | V <sub>CC</sub> at 3.3 V ±0.3 V        | 0    | 10              |      |
|                                 |                               | V <sub>CC</sub> at 5.0 V ±0.5 V        | 0    | 5               |      |
| θ <sub>JA</sub>                 | Thermal Resistance            | SC-74A / SOT23-5                       | -    | 320             | °C/W |
|                                 |                               | SC-88A                                 | -    | 377             |      |
|                                 |                               | MicroPak-6                             | -    | 154             |      |
|                                 |                               | MicroPak2-6                            | -    | 154             |      |

Functional operation above the stresses listed in the Recommended Operating Ranges is not implied. Extended exposure to stresses beyond the Recommended Operating Ranges limits may affect device reliability.

1. Unused inputs must be held HIGH or LOW. They may not float.

# NC7SZ125

## DC ELECTRICAL CHARACTERISTICS

| Symbol           | Parameter                 | V <sub>CC</sub> (V) | Conditions                                                                          | T <sub>A</sub> = +25°C |      |                      | T <sub>A</sub> = -40 to +85°C |                      | Unit |
|------------------|---------------------------|---------------------|-------------------------------------------------------------------------------------|------------------------|------|----------------------|-------------------------------|----------------------|------|
|                  |                           |                     |                                                                                     | Min                    | Typ  | Max                  | Min                           | Max                  |      |
| V <sub>IH</sub>  | HIGH Level Input Voltage  | 1.65 to 1.95        |                                                                                     | 0.65 V <sub>CC</sub>   | -    | -                    | 0.65 V <sub>CC</sub>          | -                    | V    |
|                  |                           | 2.30 to 5.50        |                                                                                     | 0.70 V <sub>CC</sub>   | -    | -                    | 0.70 V <sub>CC</sub>          | -                    |      |
| V <sub>IL</sub>  | LOW Level Input Voltage   | 1.65 to 1.95        |                                                                                     | -                      | -    | 0.35 V <sub>CC</sub> | -                             | 0.35 V <sub>CC</sub> | V    |
|                  |                           | 2.30 to 5.50        |                                                                                     | -                      | -    | 0.30 V <sub>CC</sub> | -                             | 0.30 V <sub>CC</sub> |      |
| V <sub>OH</sub>  | HIGH Level Output Voltage | 1.65                | V <sub>IN</sub> = V <sub>IH</sub> or V <sub>IL</sub> ,<br>I <sub>OH</sub> = -100 μA | 1.55                   | 1.65 | -                    | 1.55                          | -                    | V    |
|                  |                           | 1.80                |                                                                                     | 1.70                   | 1.80 | -                    | 1.70                          | -                    |      |
|                  |                           | 2.30                |                                                                                     | 2.20                   | 2.30 | -                    | 2.20                          | -                    |      |
|                  |                           | 3.00                |                                                                                     | 2.90                   | 3.00 | -                    | 2.90                          | -                    |      |
|                  |                           | 4.50                |                                                                                     | 4.40                   | 4.50 | -                    | 4.40                          | -                    |      |
|                  |                           | 1.65                | I <sub>OH</sub> = -4 mA                                                             | 1.29                   | 1.52 | -                    | 1.29                          | -                    |      |
|                  |                           | 2.30                | I <sub>OH</sub> = -8 mA                                                             | 1.90                   | 2.15 | -                    | 1.90                          | -                    |      |
|                  |                           | 3.00                | I <sub>OH</sub> = -16 mA                                                            | 2.40                   | 2.80 | -                    | 2.40                          | -                    |      |
|                  |                           | 3.00                | I <sub>OH</sub> = -24 mA                                                            | 2.30                   | 2.68 | -                    | 2.30                          | -                    |      |
|                  |                           | 4.50                | I <sub>OH</sub> = -32 mA                                                            | 3.80                   | 4.20 | -                    | 3.80                          | -                    |      |
| V <sub>OL</sub>  | LOW Level Output Voltage  | 1.65                | V <sub>IN</sub> = V <sub>IH</sub> or V <sub>IL</sub> ,<br>I <sub>OL</sub> = 100 μA  | -                      | 0.00 | 0.10                 | -                             | 0.00                 | V    |
|                  |                           | 1.80                |                                                                                     | -                      | 0.00 | 0.10                 | -                             | 0.10                 |      |
|                  |                           | 2.30                |                                                                                     | -                      | 0.00 | 0.10                 | -                             | 0.10                 |      |
|                  |                           | 3.00                |                                                                                     | -                      | 0.00 | 0.10                 | -                             | 0.10                 |      |
|                  |                           | 4.50                |                                                                                     | -                      | 0.00 | 0.10                 | -                             | 0.10                 |      |
|                  |                           | 1.65                | I <sub>OL</sub> = 4 mA                                                              | -                      | 0.80 | 0.24                 | -                             | 0.24                 |      |
|                  |                           | 2.30                | I <sub>OL</sub> = 8 mA                                                              | -                      | 0.10 | 0.30                 | -                             | 0.30                 |      |
|                  |                           | 3.00                | I <sub>OL</sub> = 16 mA                                                             | -                      | 0.15 | 0.40                 | -                             | 0.40                 |      |
|                  |                           | 3.00                | I <sub>OL</sub> = 24 mA                                                             | -                      | 0.22 | 0.55                 | -                             | 0.55                 |      |
|                  |                           | 4.50                | I <sub>OL</sub> = 32 mA                                                             | -                      | 0.22 | 0.55                 | -                             | 0.55                 |      |
| I <sub>IN</sub>  | Input Leakage Current     | 1.65 to 5.5         | 0 ≥ V <sub>IN</sub> ≥ 5.5 V                                                         | -                      | -    | ±1                   | -                             | ±10                  | μA   |
| I <sub>OZ</sub>  | 3-STATE Output Leakage    | 0 to 5.5            | V <sub>IN</sub> = V <sub>IH</sub> or V <sub>IL</sub><br>0 ≥ V <sub>O</sub> ≥ 5.5 V  | -                      | -    | ±1                   | -                             | ±10                  | μA   |
| I <sub>OFF</sub> | Power Off Leakage Current | 0                   | V <sub>IN</sub> or V <sub>OUT</sub> = 5.5 V                                         | -                      | -    | 1                    | -                             | 10                   | μA   |
| I <sub>CC</sub>  | Quiescent Supply Current  | 1.65 to 5.50        | V <sub>IN</sub> = 5.5 V, GND                                                        | -                      | -    | 2                    | -                             | 20                   | μA   |

# NC7SZ125

## AC ELECTRICAL CHARACTERISTICS

| Symbol                              | Parameter                                         | V <sub>CC</sub> (V) | Conditions                                                                                                                                                                                                                 | T <sub>A</sub> = +25°C |     |      | T <sub>A</sub> = -40 to +85°C |      | Unit |
|-------------------------------------|---------------------------------------------------|---------------------|----------------------------------------------------------------------------------------------------------------------------------------------------------------------------------------------------------------------------|------------------------|-----|------|-------------------------------|------|------|
|                                     |                                                   |                     |                                                                                                                                                                                                                            | Min                    | Typ | Max  | Min                           | Max  |      |
| t <sub>PLH</sub> , t <sub>PHL</sub> | Propagation Delay (Figure 4, 6)                   | 1.65                | C <sub>L</sub> = 15 pF,<br>R <sub>D</sub> = 1 MΩ<br>S <sub>1</sub> = OPEN                                                                                                                                                  | -                      | 6.4 | 13.2 | -                             | 13.8 | ns   |
|                                     |                                                   | 1.80                |                                                                                                                                                                                                                            | -                      | 5.3 | 11.0 | -                             | 11.5 |      |
|                                     |                                                   | 2.50 ±0.20          |                                                                                                                                                                                                                            | -                      | 3.4 | 7.5  | -                             | 8.0  |      |
|                                     |                                                   | 3.30 ±0.30          |                                                                                                                                                                                                                            | -                      | 2.5 | 5.2  | -                             | 5.5  |      |
|                                     |                                                   | 5.00 ±0.50          |                                                                                                                                                                                                                            | -                      | 2.1 | 4.5  | -                             | 4.8  |      |
|                                     |                                                   | 3.30 ±0.30          | C <sub>L</sub> = 50 pF,<br>R <sub>D</sub> = 500 Ω<br>S <sub>1</sub> = OPEN                                                                                                                                                 | -                      | 3.2 | 5.7  | -                             | 6.0  |      |
|                                     |                                                   | 5.00 ±0.50          |                                                                                                                                                                                                                            | -                      | 2.6 | 5.0  | -                             | 5.3  |      |
| t <sub>PZL</sub> , t <sub>PZH</sub> | Output Enable Time (Figure 4, 6)                  | 1.65                | C <sub>L</sub> = 50 pF,<br>R <sub>D</sub> = 500 Ω<br>R <sub>U</sub> = 500 Ω<br>S <sub>1</sub> = GND for t <sub>PZH</sub><br>S <sub>1</sub> = V <sub>IN</sub> for t <sub>PZL</sub><br>V <sub>IN</sub> = 2 · V <sub>CC</sub> | -                      | 8.4 | 15.0 | -                             | 15.6 | ns   |
|                                     |                                                   | 1.80                |                                                                                                                                                                                                                            | -                      | 7.0 | 12.5 | -                             | 13.0 |      |
|                                     |                                                   | 2.50 ±0.20          |                                                                                                                                                                                                                            | -                      | 4.6 | 8.5  | -                             | 9.0  |      |
|                                     |                                                   | 3.30 ±0.30          |                                                                                                                                                                                                                            | -                      | 3.5 | 6.2  | -                             | 6.5  |      |
|                                     |                                                   | 5.00 ±0.50          |                                                                                                                                                                                                                            | -                      | 2.8 | 5.5  | -                             | 5.8  |      |
| t <sub>PLZ</sub> , t <sub>PHZ</sub> | Output Disable Time (Figure 4, 6)                 | 1.65                | C <sub>L</sub> = 50 pF,<br>R <sub>D</sub> = 500 Ω<br>R <sub>U</sub> = 500 Ω<br>S <sub>1</sub> = GND for t <sub>PHZ</sub><br>S <sub>1</sub> = V <sub>IN</sub> for t <sub>PLZ</sub><br>V <sub>IN</sub> = 2 · V <sub>CC</sub> | -                      | 6.5 | 13.2 | -                             | 14.5 |      |
|                                     |                                                   | 1.80                |                                                                                                                                                                                                                            | -                      | 5.4 | 11.0 | -                             | 12.0 |      |
|                                     |                                                   | 2.50 ±0.20          |                                                                                                                                                                                                                            | -                      | 3.5 | 8.0  | -                             | 8.5  |      |
|                                     |                                                   | 3.30 ±0.30          |                                                                                                                                                                                                                            | -                      | 2.8 | 5.7  | -                             | 6.0  |      |
|                                     |                                                   | 5.00 ±0.50          |                                                                                                                                                                                                                            | -                      | 2.1 | 4.7  | -                             | 5.0  |      |
| C <sub>IN</sub>                     | Input Capacitance                                 | 0.00                |                                                                                                                                                                                                                            | -                      | 4   | -    | -                             | -    | pF   |
| C <sub>OUT</sub>                    | Output Capacitance                                | 0.00                |                                                                                                                                                                                                                            | -                      | 8   | -    | -                             | -    |      |
| C <sub>PD</sub>                     | Power Dissipation Capacitance (Note 2) (Figure 5) | 3.30                |                                                                                                                                                                                                                            | -                      | 17  | -    | -                             | -    | pF   |

2. C<sub>PD</sub> is defined as the value of the internal equivalent capacitance which is derived from dynamic operating current consumption (I<sub>CCD</sub>) at no output loading and operating at 50% duty cycle. C<sub>PD</sub> is related to I<sub>CCD</sub> dynamic operating current by the expression:  
 $I_{CCD} = (C_{PD}) (V_{CC}) (f_{IN}) + (I_{CCstatic})$ .

# NC7SZ125

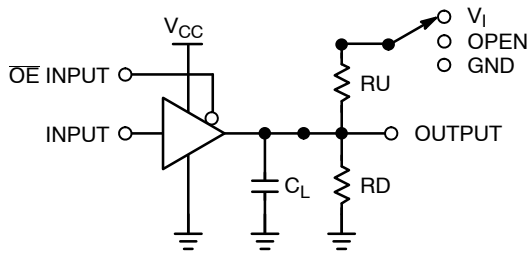

NOTE:  
3.  $C_L$  includes load and stray capacitance;  
Input PRR = 1.0 MHz;  $t_W = 500$  ns

Figure 4. AC Test Circuit

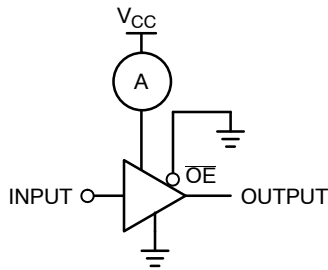

NOTE:  
4. Input = AC Waveform;  $t_r = t_f = 1.8$  ns;  
PRR = 10 MHz; Duty Cycle = 50%.

Figure 5.  $I_{CCD}$  Test Circuit

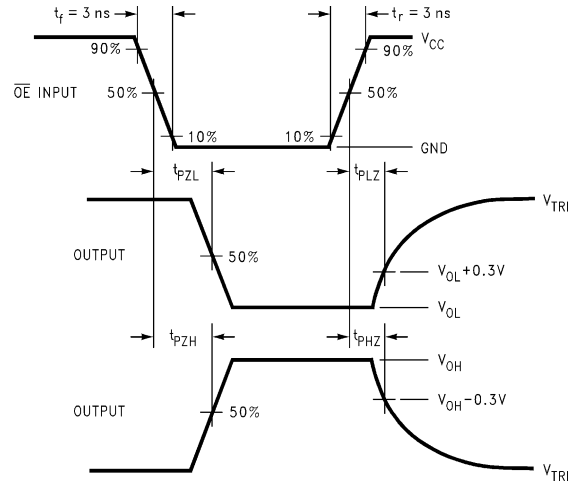
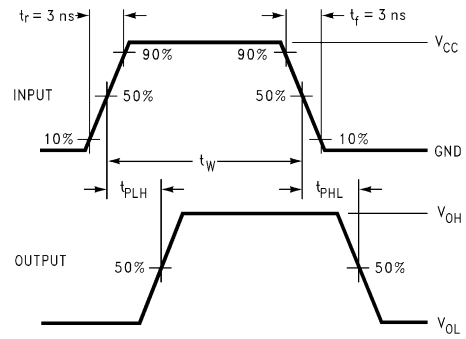

Figure 6. AC Waveforms

## ORDERING INFORMATION

| Part Number        | Top Mark | Operating Temperature | Packages  | Shipping†          |
|--------------------|----------|-----------------------|-----------|--------------------|
| NC7SZ125M5X        | 7Z25     | -40 to +85°C          | SC-74A    | 3000 / Tape & Reel |
| NC7SZ125M5X-L22090 | 7Z25     | -40 to +85°C          | SOT23-5   | 3000 / Tape & Reel |
| NC7SZ125P5X        | Z25      | -40 to +85°C          | SC-88A    | 3000 / Tape & Reel |
| NC7SZ125P5X-F22057 | Z25      | -40 to +85°C          | SC-88A    | 3000 / Tape & Reel |
| NC7SZ125L6X        | DD       | -40 to +85°C          | MicroPak  | 5000 / Tape & Reel |
| NC7SZ125L6X-L22175 | DD       | -40 to +85°C          | MicroPak  | 5000 / Tape & Reel |
| NC7SZ125FHX        | DD       | -40 to +85°C          | MicroPak2 | 5000 / Tape & Reel |
| NC7SZ125FHX-L22175 | DD       | -40 to +85°C          | MicroPak2 | 5000 / Tape & Reel |

†For information on tape and reel specifications, including part orientation and tape sizes, please refer to our Tape and Reel Packaging Specifications Brochure, BRD8011/D.

MicroPak and MicroPak2 are trademarks of Semiconductor Components Industries, LLC dba "onsemi" or its affiliates and/or subsidiaries in the United States and/or other countries.



**SIP6 1.45X1.0**  
CASE 127EB  
ISSUE O

DATE 31 AUG 2016

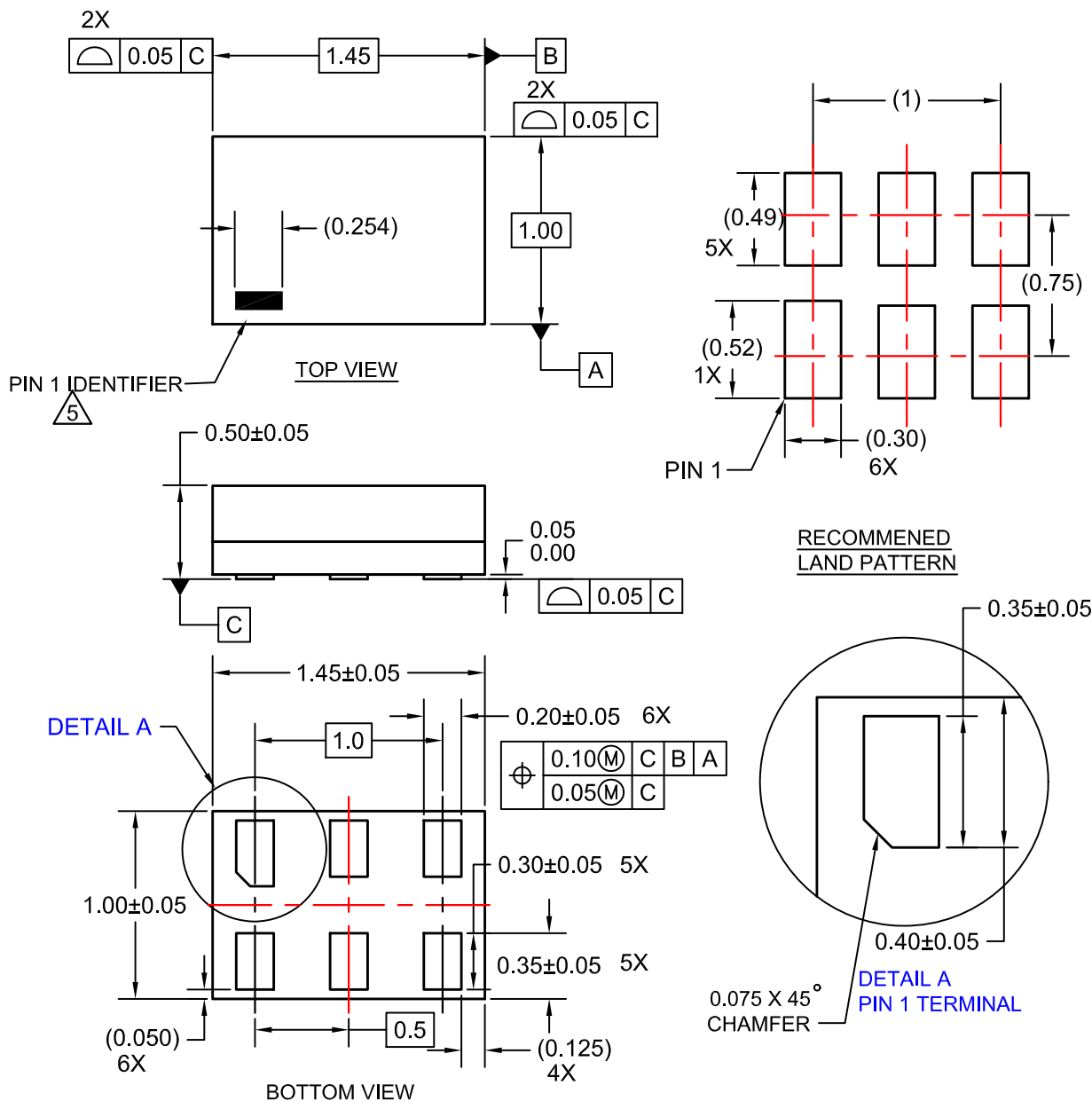

**NOTES:**

1. CONFORMS TO JEDEC STANDARD MO-252 VARIATION UAAD
2. DIMENSIONS ARE IN MILLIMETERS
3. DRAWING CONFORMS TO ASME Y14.5M-2009
4. PIN ONE IDENTIFIER IS 2X LENGTH OF ANY OTHER LINE IN THE MARK CODE LAYOUT.

|                         |                      |                                                                                                                                                                                  |
|-------------------------|----------------------|----------------------------------------------------------------------------------------------------------------------------------------------------------------------------------|
| <b>DOCUMENT NUMBER:</b> | <b>98AON13590G</b>   | Electronic versions are uncontrolled except when accessed directly from the Document Repository. Printed versions are uncontrolled except when stamped "CONTROLLED COPY" in red. |
| <b>DESCRIPTION:</b>     | <b>SIP6 1.45X1.0</b> | <b>PAGE 1 OF 1</b>                                                                                                                                                               |

ON Semiconductor and are trademarks of Semiconductor Components Industries, LLC dba ON Semiconductor or its subsidiaries in the United States and/or other countries. ON Semiconductor reserves the right to make changes without further notice to any products herein. ON Semiconductor makes no warranty, representation or guarantee regarding the suitability of its products for any particular purpose, nor does ON Semiconductor assume any liability arising out of the application or use of any product or circuit, and specifically disclaims any and all liability, including without limitation special, consequential or incidental damages. ON Semiconductor does not convey any license under its patent rights nor the rights of others.

# MECHANICAL CASE OUTLINE

## PACKAGE DIMENSIONS

ON Semiconductor®

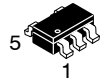

SCALE 2:1

### SC-74A CASE 318BQ ISSUE B

DATE 18 JAN 2018

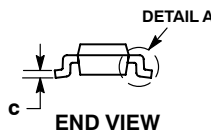

NOTES:

1. DIMENSIONING AND TOLERANCING PER ASME Y14.5M, 1994.
2. CONTROLLING DIMENSION: MILLIMETERS.
3. MAXIMUM LEAD THICKNESS INCLUDES LEAD FINISH THICKNESS. MINIMUM LEAD THICKNESS IS THE MINIMUM THICKNESS OF BASE MATERIAL.
4. DIMENSIONS A AND B DO NOT INCLUDE MOLD FLASH, PROTRUSIONS, OR GATE BURRS. MOLD FLASH, PROTRUSIONS, OR GATE BURRS SHALL NOT EXCEED 0.15 PER SIDE.

| DIM | MILLIMETERS |      |
|-----|-------------|------|
|     | MIN         | MAX  |
| A   | 0.90        | 1.10 |
| A1  | 0.01        | 0.10 |
| b   | 0.25        | 0.50 |
| c   | 0.10        | 0.26 |
| D   | 2.85        | 3.15 |
| E   | 2.50        | 3.00 |
| E1  | 1.35        | 1.65 |
| e   | 0.95 BSC    |      |
| L   | 0.20        | 0.60 |
| M   | 0°          | 10°  |

#### RECOMMENDED SOLDERING FOOTPRINT\*

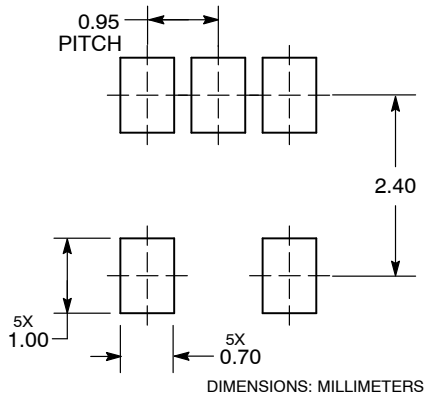

#### GENERIC MARKING DIAGRAM\*

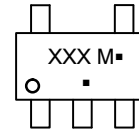

- XXX = Specific Device Code
- M = Date Code
- = Pb-Free Package

(Note: Microdot may be in either location)

\*This information is generic. Please refer to device data sheet for actual part marking. Pb-Free indicator, "G" or microdot "▪", may or may not be present. Some products may not follow the Generic Marking.

\*For additional information on our Pb-Free strategy and soldering details, please download the ON Semiconductor Soldering and Mounting Techniques Reference Manual, SOLDERRM/D.

|                         |                    |                                                                                                                                                                                  |
|-------------------------|--------------------|----------------------------------------------------------------------------------------------------------------------------------------------------------------------------------|
| <b>DOCUMENT NUMBER:</b> | <b>98AON66279G</b> | Electronic versions are uncontrolled except when accessed directly from the Document Repository. Printed versions are uncontrolled except when stamped "CONTROLLED COPY" in red. |
| <b>DESCRIPTION:</b>     | <b>SC-74A</b>      | <b>PAGE 1 OF 1</b>                                                                                                                                                               |

ON Semiconductor and are trademarks of Semiconductor Components Industries, LLC dba ON Semiconductor or its subsidiaries in the United States and/or other countries. ON Semiconductor reserves the right to make changes without further notice to any products herein. ON Semiconductor makes no warranty, representation or guarantee regarding the suitability of its products for any particular purpose, nor does ON Semiconductor assume any liability arising out of the application or use of any product or circuit, and specifically disclaims any and all liability, including without limitation special, consequential or incidental damages. ON Semiconductor does not convey any license under its patent rights nor the rights of others.



# MECHANICAL CASE OUTLINE PACKAGE DIMENSIONS



SCALE 2:1

## SC-88A (SC-70-5/SOT-353) CASE 419A-02 ISSUE M

DATE 11 APR 2023

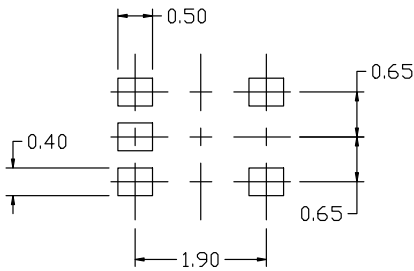
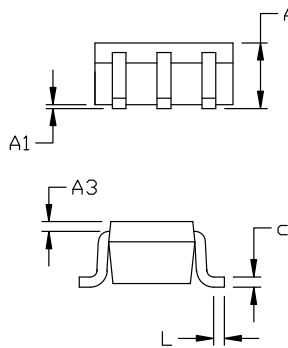
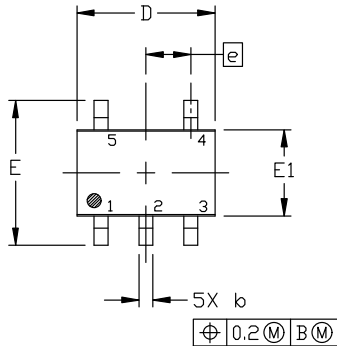

### RECOMMENDED MOUNTING FOOTPRINT

\* For additional information on our Pb-Free strategy and soldering details, please download the ON Semiconductor Soldering and Mounting Techniques Reference Manual, SOLDERM/D.

### NOTES:

1. DIMENSIONING AND TOLERANCING PER ANSI Y14.5M, 1982.
2. CONTROLLING DIMENSION: MILLIMETERS
3. 419A-01 OBSOLETE. NEW STANDARD 419A-02
4. DIMENSIONS D AND E1 DO NOT INCLUDE MOLD FLASH, PROTRUSIONS, OR GATE BURRS. MOLD FLASH, PROTRUSIONS, OR GATE BURRS SHALL NOT EXCEED 0.1016MM PER SIDE.

| DIM | MILLIMETERS |      |      |
|-----|-------------|------|------|
|     | MIN.        | NOM. | MAX. |
| A   | 0.80        | 0.95 | 1.10 |
| A1  | ---         | ---  | 0.10 |
| A3  | 0.20 REF    |      |      |
| b   | 0.10        | 0.20 | 0.30 |
| c   | 0.10        | ---  | 0.25 |
| D   | 1.80        | 2.00 | 2.20 |
| E   | 2.00        | 2.10 | 2.20 |
| E1  | 1.15        | 1.25 | 1.35 |
| e   | 0.65 BSC    |      |      |
| L   | 0.10        | 0.15 | 0.30 |

### GENERIC MARKING DIAGRAM\*

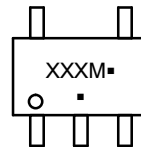

\*This information is generic. Please refer to device data sheet for actual part marking. Pb-Free indicator, "G" or microdot "▪", may or may not be present. Some products may not follow the Generic Marking.

XXX = Specific Device Code

M = Date Code

▪ = Pb-Free Package

(Note: Microdot may be in either location)

#### STYLE 1:

1. BASE
2. EMITTER
3. BASE
4. COLLECTOR
5. COLLECTOR

#### STYLE 2:

1. ANODE
2. EMITTER
3. BASE
4. COLLECTOR
5. CATHODE

#### STYLE 3:

1. ANODE 1
2. N/C
3. ANODE 2
4. CATHODE 2
5. CATHODE 1

#### STYLE 4:

1. SOURCE 1
2. DRAIN 1/2
3. SOURCE 1
4. GATE 1
5. GATE 2

#### STYLE 5:

1. CATHODE
2. COMMON ANODE
3. CATHODE 2
4. CATHODE 3
5. CATHODE 4

#### STYLE 6:

1. EMITTER 2
2. BASE 2
3. EMITTER 1
4. COLLECTOR
5. COLLECTOR 2/BASE 1

#### STYLE 7:

1. BASE
2. EMITTER
3. BASE
4. COLLECTOR
5. COLLECTOR

#### STYLE 8:

1. CATHODE
2. COLLECTOR
3. N/C
4. BASE
5. EMITTER

#### STYLE 9:

1. ANODE
2. CATHODE
3. ANODE
4. ANODE
5. ANODE

Note: Please refer to datasheet for style callout. If style type is not called out in the datasheet refer to the device datasheet pinout or pin assignment.

|                         |                                 |                                                                                                                                                                                     |
|-------------------------|---------------------------------|-------------------------------------------------------------------------------------------------------------------------------------------------------------------------------------|
| <b>DOCUMENT NUMBER:</b> | <b>98ASB42984B</b>              | Electronic versions are uncontrolled except when accessed directly from the Document Repository.<br>Printed versions are uncontrolled except when stamped "CONTROLLED COPY" in red. |
| <b>DESCRIPTION:</b>     | <b>SC-88A (SC-70-5/SOT-353)</b> | <b>PAGE 1 OF 1</b>                                                                                                                                                                  |

onsemi and ONSEMI are trademarks of Semiconductor Components Industries, LLC dba onsemi or its subsidiaries in the United States and/or other countries. onsemi reserves the right to make changes without further notice to any products herein. onsemi makes no warranty, representation or guarantee regarding the suitability of its products for any particular purpose, nor does onsemi assume any liability arising out of the application or use of any product or circuit, and specifically disclaims any and all liability, including without limitation special, consequential or incidental damages. onsemi does not convey any license under its patent rights nor the rights of others.



# MECHANICAL CASE OUTLINE PACKAGE DIMENSIONS

ON Semiconductor®



## SOT-23, 5 Lead CASE 527AH ISSUE A

DATE 09 JUN 2021

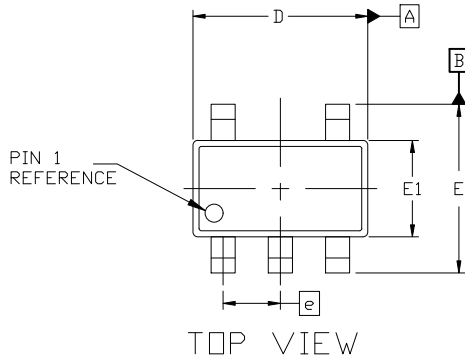

NOTES:

1. DIMENSIONING AND TOLERANCING PER ASME Y14.5M, 1989A
2. CONTROLLING DIMENSION: MILLIMETERS
3. MAXIMUM LEAD THICKNESS INCLUDES LEAD FINISH THICKNESS. MINIMUM LEAD THICKNESS IS THE MINIMUM THICKNESS OF THE BASE MATERIAL.
4. DIMENSIONS D AND E1 DO NOT INCLUDE MOLD FLASH, PROTRUSIONS, OR GATE BURRS. MOLD FLASH, PROTRUSIONS, OR GATE BURRS SHALL NOT EXCEED 0.25 PER SIDE. D AND E1 DIMENSIONS ARE DETERMINED AT DATUM D.
5. DIMENSION 'b' DOES NOT INCLUDE DAMBAR PROTRUSION. ALLOWABLE DAMBAR PROTRUSION SHALL BE 0.08mm TOTAL IN EXCESS OF THE 'b' DIMENSION AT MAXIMUM MATERIAL CONDITION. MINIMUM SPACE BETWEEN PROTRUSION AND AN ADJACENT LEAD SHALL NOT BE LESS THAN 0.07mm.



| DIM    | MILLIMETERS |      |      |
|--------|-------------|------|------|
|        | MIN.        | NOM. | MAX. |
| A      | 0.90        | —    | 1.45 |
| A1     | 0.00        | —    | 0.15 |
| A2     | 0.90        | 1.15 | 1.30 |
| b      | 0.30        | —    | 0.50 |
| c      | 0.08        | —    | 0.22 |
| D      | 2.90 BSC    |      |      |
| E      | 2.80 BSC    |      |      |
| E1     | 1.60 BSC    |      |      |
| e      | 0.95 BSC    |      |      |
| L      | 0.30        | 0.45 | 0.60 |
| L1     | 0.60 REF    |      |      |
| L2     | 0.25 REF    |      |      |
| theta  | 0°          | 4°   | 8°   |
| theta1 | 0°          | 10°  | 15°  |
| theta2 | 0°          | 10°  | 15°  |

### GENERIC MARKING DIAGRAM\*



XXX = Specific Device Code  
M = Date Code

\*This information is generic. Please refer to device data sheet for actual part marking. Pb-Free indicator, "G" or microdot "•", may or may not be present. Some products may not follow the Generic Marking.



For additional information on our Pb-Free strategy and soldering details, please download the ON Semiconductor Soldering and Mounting Techniques Reference Manual, SOLDERRM/D.

|                         |                       |                                                                                                                                                                                  |
|-------------------------|-----------------------|----------------------------------------------------------------------------------------------------------------------------------------------------------------------------------|
| <b>DOCUMENT NUMBER:</b> | <b>98AON34320E</b>    | Electronic versions are uncontrolled except when accessed directly from the Document Repository. Printed versions are uncontrolled except when stamped "CONTROLLED COPY" in red. |
| <b>DESCRIPTION:</b>     | <b>SOT-23, 5 LEAD</b> | <b>PAGE 1 OF 1</b>                                                                                                                                                               |

ON Semiconductor and ON are trademarks of Semiconductor Components Industries, LLC dba ON Semiconductor or its subsidiaries in the United States and/or other countries. ON Semiconductor reserves the right to make changes without further notice to any products herein. ON Semiconductor makes no warranty, representation or guarantee regarding the suitability of its products for any particular purpose, nor does ON Semiconductor assume any liability arising out of the application or use of any product or circuit, and specifically disclaims any and all liability, including without limitation special, consequential or incidental damages. ON Semiconductor does not convey any license under its patent rights nor the rights of others.

**onsemi**, **Onsemi**, and other names, marks, and brands are registered and/or common law trademarks of Semiconductor Components Industries, LLC dba "**onsemi**" or its affiliates and/or subsidiaries in the United States and/or other countries. **onsemi** owns the rights to a number of patents, trademarks, copyrights, trade secrets, and other intellectual property. A listing of **onsemi**'s product/patent coverage may be accessed at [www.onsemi.com/site/pdf/Patent-Marking.pdf](http://www.onsemi.com/site/pdf/Patent-Marking.pdf). **onsemi** reserves the right to make changes at any time to any products or information herein, without notice. The information herein is provided "as-is" and **onsemi** makes no warranty, representation or guarantee regarding the accuracy of the information, product features, availability, functionality, or suitability of its products for any particular purpose, nor does **onsemi** assume any liability arising out of the application or use of any product or circuit, and specifically disclaims any and all liability, including without limitation special, consequential or incidental damages. Buyer is responsible for its products and applications using **onsemi** products, including compliance with all laws, regulations and safety requirements or standards, regardless of any support or applications information provided by **onsemi**. "Typical" parameters which may be provided in **onsemi** data sheets and/or specifications can and do vary in different applications and actual performance may vary over time. All operating parameters, including "Typicals" must be validated for each customer application by customer's technical experts. **onsemi** does not convey any license under any of its intellectual property rights nor the rights of others. **onsemi** products are not designed, intended, or authorized for use as a critical component in life support systems or any FDA Class 3 medical devices or medical devices with a same or similar classification in a foreign jurisdiction or any devices intended for implantation in the human body. Should Buyer purchase or use **onsemi** products for any such unintended or unauthorized application, Buyer shall indemnify and hold **onsemi** and its officers, employees, subsidiaries, affiliates, and distributors harmless against all claims, costs, damages, and expenses, and reasonable attorney fees arising out of, directly or indirectly, any claim of personal injury or death associated with such unintended or unauthorized use, even if such claim alleges that **onsemi** was negligent regarding the design or manufacture of the part. **onsemi** is an Equal Opportunity/Affirmative Action Employer. This literature is subject to all applicable copyright laws and is not for resale in any manner.

## ADDITIONAL INFORMATION

### TECHNICAL PUBLICATIONS:

Technical Library: [www.onsemi.com/design/resources/technical-documentation](http://www.onsemi.com/design/resources/technical-documentation)  
onsemi Website: [www.onsemi.com](http://www.onsemi.com)

### ONLINE SUPPORT: [www.onsemi.com/support](http://www.onsemi.com/support)

For additional information, please contact your local Sales Representative at [www.onsemi.com/support/sales](http://www.onsemi.com/support/sales)