

# TinyLogic HST 2-Input AND Gate

## NC7ST08

### Description

The NC7ST08 is a single 2-Input high performance CMOS AND Gate, with TTL-compatible inputs. Advanced Silicon Gate CMOS fabrication assures high speed and low power circuit operation. ESD protection diodes inherently guard both inputs and output with respect to the V<sub>CC</sub> and GND rails. High gain circuitry offers high noise immunity and reduced sensitivity to input edge rate. The TTL-compatible inputs facilitate TTL to NMOS / CMOS interfacing. Device performance is similar to MM74HCT but with 1/2 the output current drive of HC / HCT.

### Features

- Space Saving SOT23-5, SC-74A and SC-88A 5-Lead Package
- Ultra Small MicroPak™ Leadless Package
- High Speed: t<sub>PD</sub> = 6 ns (Typ), V<sub>CC</sub> = 5 V, C<sub>L</sub> = 15 pF, T<sub>A</sub> = 25°C
- Low Quiescent Power: I<sub>CC</sub> < 1 μA Typ, V<sub>CC</sub> = 5.5 V
- Balanced Output Drive: 2 mA I<sub>OL</sub>, -2 mA I<sub>OH</sub>
- TTL-compatible Inputs
- These Devices are Pb-Free, Halogen Free/BFR Free and are RoHS Compliant

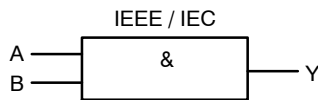
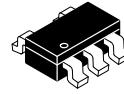
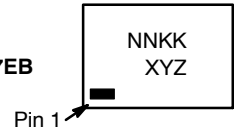

Figure 1. Logic Symbol

### MARKING DIAGRAMS



SIP6  
CASE 127EB



SC-74A  
CASE 318BQ

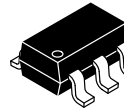
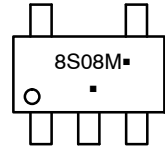

SOT23-5  
CASE 527AH

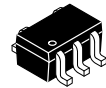
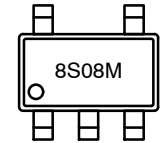

SC-88A  
CASE 419A-02

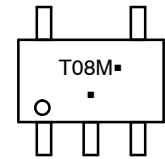

NN, 8S08, T08 = Specific Device Code  
KK = 2-Digit Lot Run Traceability Code  
XY = 2-Digit Date Code Format  
Z = Assembly Plant Code  
M = Date Code\*

\*Date Code orientation and/or position may vary depending upon manufacturing location.

### ORDERING INFORMATION

See detailed ordering, marking and shipping information in the package dimensions section on page 4 of this data sheet.

# NC7ST08

## Pin Configurations

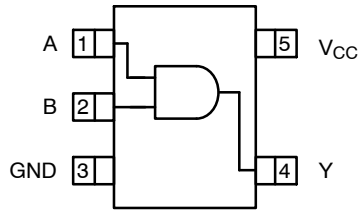

Figure 2. SOT23-5, SC-88A and SC-74A (Top View)

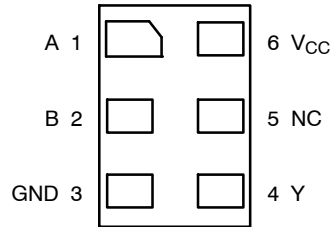

Figure 3. MicroPak (Top Through View)

### PIN DESCRIPTION

Pin Names	Description
A, B	Inputs
Y	Output
NC	No Connect

### FUNCTION TABLE (Y = AB)

Inputs		Output
A	B	Y
L	L	L
L	H	L
H	L	L
H	H	H

H = HIGH Logic Level  
L = LOW Logic Level

### ABSOLUTE MAXIMUM RATINGS

Symbol	Parameter		Min	Max	Unit
$V_{CC}$	Supply Voltage		-0.5	6.5	V
$I_{IK}$	DC Input Diode Current	$V_{IN} < 0\text{ V}$	-	-20	mA
		$V_{IN} > V_{CC}$	-	+20	
$V_{IN}$	DC Input Voltage		-0.5	$V_{CC} + 0.5$	V
$I_{OK}$	DC Output Diode Current	$V_{OUT} < 0\text{ V}$	-	-20	mA
		$V_{OUT} > V_{CC}$	-	+20	
$V_{OUT}$	Output Voltage		-0.5	$V_{CC} + 0.5$	V
$I_{OUT}$	DC Output Source or Sink Current		-	$\pm 12.5$	mA
$I_{CC}$ or $I_{GND}$	DC $V_{CC}$ or Ground Current per Supply Pin		-	$\pm 25$	mA
$T_{STG}$	Storage Temperature		-65	+150	$^{\circ}\text{C}$
$T_J$	Junction Temperature		-	+150	$^{\circ}\text{C}$
$T_L$	Lead Temperature (Soldering, 10 Seconds)		-	+260	$^{\circ}\text{C}$
$P_D$	Power Dissipation in Still Air	SC-74A / SOT23-5	-	390	mW
		SC-88A	-	332	
		MicroPak-6	-	812	

Stresses exceeding those listed in the Maximum Ratings table may damage the device. If any of these limits are exceeded, device functionality should not be assumed, damage may occur and reliability may be affected.

# NC7ST08

## RECOMMENDED OPERATING CONDITIONS

Symbol	Parameter	Conditions	Min	Max	Unit
V <sub>CC</sub>	Supply Voltage		4.5	5.5	V
V <sub>IN</sub>	Input Voltage		0	V <sub>CC</sub>	V
V <sub>OUT</sub>	Output Voltage		0	V <sub>CC</sub>	V
T <sub>A</sub>	Operating Temperature		-40	+85	°C
t <sub>r</sub> , t <sub>f</sub>	Input Rise and Fall Time	V <sub>CC</sub> = 5.0 V	0	10	ns/V
θ <sub>JA</sub>	Thermal Resistance	SC-74A / SOT23-5	-	320	°C/W
		SC-88A	-	377	
		MicroPak-6	-	154	

Functional operation above the stresses listed in the Recommended Operating Ranges is not implied. Extended exposure to stresses beyond the Recommended Operating Ranges limits may affect device reliability.

1. Unused inputs must be held HIGH or LOW. They may not float.

## DC ELECTRICAL CHARACTERISTICS

Symbol	Parameter	V <sub>CC</sub> (V)	Conditions	T <sub>A</sub> = +25°C			T <sub>A</sub> = -40 to +85°C		Unit
				Min	Typ	Max	Min	Max	
V <sub>IH</sub>	HIGH Level Input Voltage	4.5 – 5.5		2.0	-	-	2.0	-	V
V <sub>IL</sub>	LOW Level Input Voltage	4.5 – 5.5		-	-	0.8	-	0.8	V
V <sub>OH</sub>	HIGH Level Output Voltage	4.5 4.5	I <sub>OH</sub> = -20 μA I <sub>OH</sub> = -2 mA V <sub>IN</sub> = V <sub>IH</sub>	4.4 4.18	4.5 4.35	-	4.4 4.13	-	V
V <sub>OL</sub>	LOW Level Output Voltage	4.5 4.5	I <sub>OL</sub> = 20 μA I <sub>OL</sub> = 2 mA V <sub>IN</sub> = V <sub>IL</sub>	-	0 0.10	0.1 0.26	-	0.1 0.33	V
I <sub>IN</sub>	Input Leakage Current	5.5	0 ≤ V <sub>IN</sub> ≤ 5.5 V	-	-	±0.1	-	±1.0	μA
I <sub>CC</sub>	Quiescent Supply Current	5.5	V <sub>IN</sub> = V <sub>CC</sub> or GND	-	-	1.0	-	10.0	μA
I <sub>CCT</sub>	I <sub>CC</sub> per Input	5.5	One Input V <sub>IN</sub> = 0.5 V or 2.4 V, Other Input V <sub>CC</sub> or GND	-	-	2.0	-	2.9	mA

## AC ELECTRICAL CHARACTERISTICS

Symbol	Parameter	V <sub>CC</sub> (V)	Conditions	T <sub>A</sub> = +25°C			T <sub>A</sub> = -40 to +85°C		Unit
				Min	Typ	Max	Min	Max	
t <sub>PLH</sub> , t <sub>PHL</sub>	Propagation Delay (Figure 4, 6)	5.0	C <sub>L</sub> = 15 pF	-	4	12	-	-	ns
				-	6	17	-	-	
		4.5	C <sub>L</sub> = 50 pF	-	6	16	-	20	
				-	12	27	-	31	
		5.5		-	5	14	-	18	
				-	11	26	-	30	
t <sub>TLH</sub> , t <sub>THL</sub>	Output Transition Time (Figure 4, 6)	5.0	C <sub>L</sub> = 15 pF	-	4	10	-	-	ns
		4.5	C <sub>L</sub> = 50 pF	-	11	25	-	31	
		5.5		-	10	21	-	26	
C <sub>IN</sub>	Input Capacitance	Open		-	-	10	-	-	pF
C <sub>PD</sub>	Power Dissipation Capacitance (Figure 5)	5.0	(Note 2)	-	6	-	-	-	pF

2. C<sub>PD</sub> is defined as the value of the internal equivalent capacitance which is derived from dynamic operating current. Current consumption (I<sub>CCD</sub>) at no output loading and operating at 50% duty cycle. (See Figure 5) C<sub>PD</sub> is related to I<sub>CCD</sub> dynamic operating current by the expression: I<sub>CCD</sub> = (C<sub>PD</sub>) (V<sub>CC</sub>) (f<sub>IN</sub>) + (I<sub>CCstatic</sub>).

# NC7ST08

## AC Loading and Waveforms

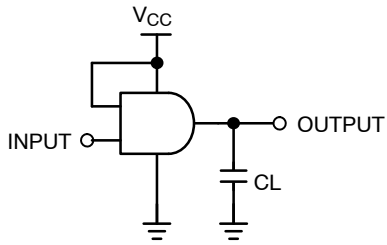

$C_L$  includes load and stray capacitance  
Input PRR = 1.0 MHz,  $t_W = 500$  ns

**Figure 4. AC Test Circuit**

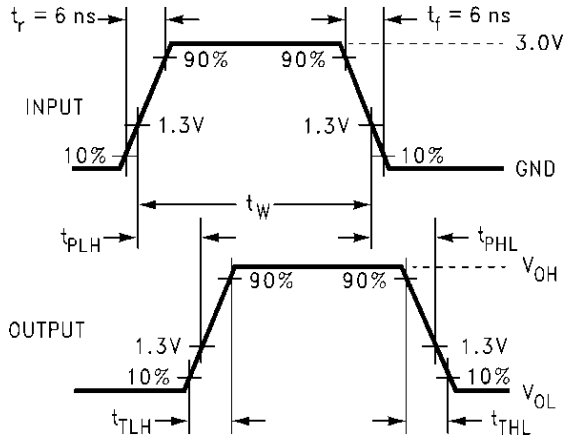

**Figure 6. AC Waveforms**

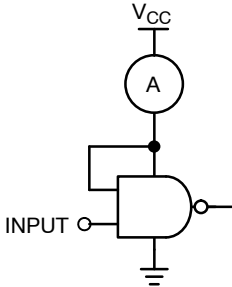

Input = AC Waveform;  
PRR = Variable; Duty Cycle = 50%.

**Figure 5.  $I_{CCD}$  Test Circuit**

## DEVICE ORDERING INFORMATION

Device	Top Mark	Packages	Shipping <sup>†</sup>
NC7ST08M5X	8S08	SC-74A	3000 / Tape & Reel
NC7ST08M5X-L22090	8S08	SOT23-5	3000 / Tape & Reel
NC7ST08P5X	T08	SC-88A	3000 / Tape & Reel
NC7ST08P5X-L22057	T08	SC-88A	3000 / Tape & Reel
NC7ST08L6X	NN	SIP6, MicroPak	5000 / Tape & Reel
NC7ST08L6X-L22175	NN	SIP6, MicroPak	5000 / Tape & Reel

<sup>†</sup>For information on tape and reel specifications, including part orientation and tape sizes, please refer to our Tape and Reel Packaging Specifications Brochure, BRD8011/D.

MicroPak is trademark of Semiconductor Components Industries, LLC (SCILLC) or its subsidiaries in the United States and/or other countries.

# MECHANICAL CASE OUTLINE

## PACKAGE DIMENSIONS

ON Semiconductor®



SIP6 1.45X1.0  
CASE 127EB  
ISSUE O

DATE 31 AUG 2016

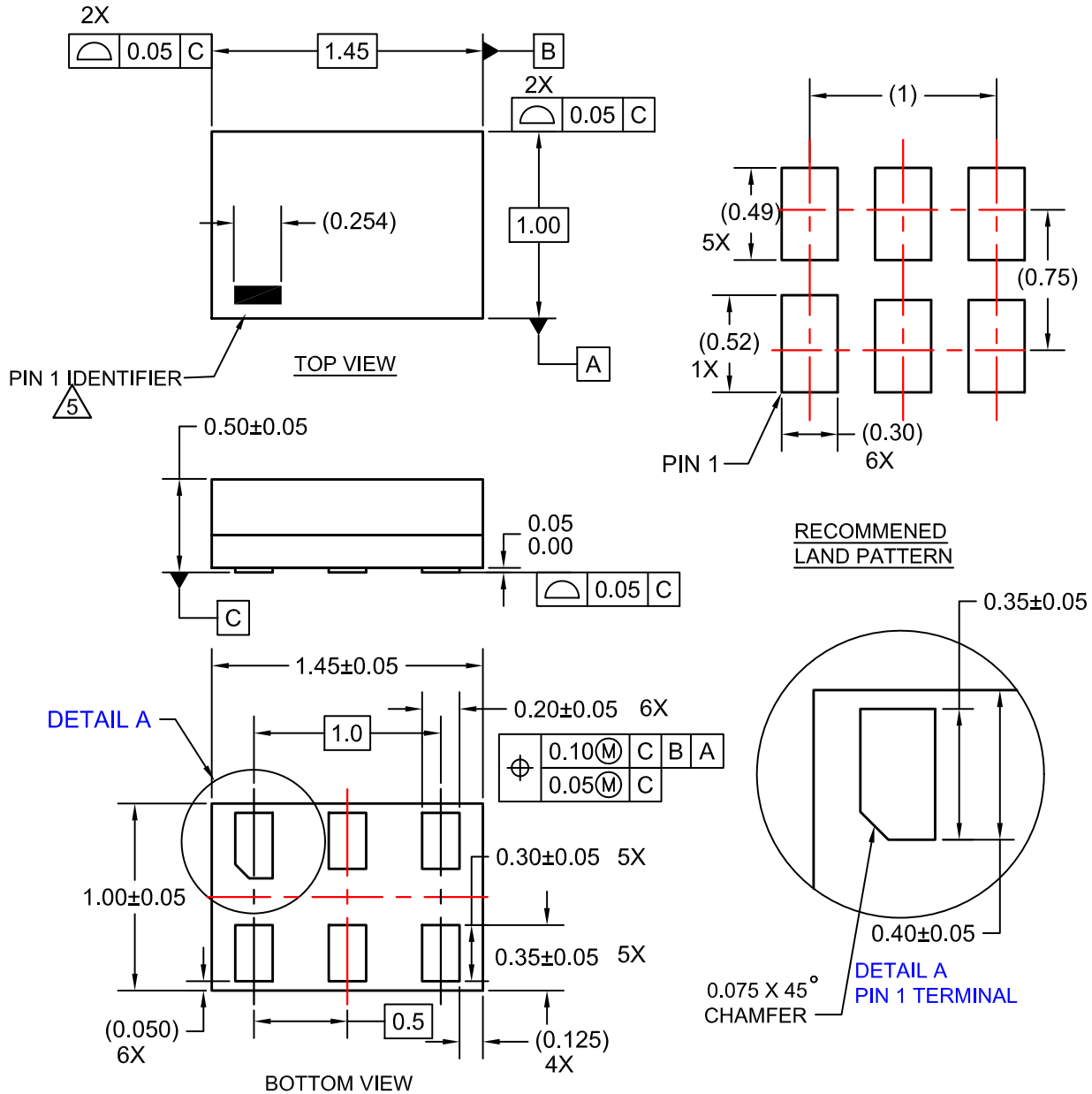

NOTES:

1. CONFORMS TO JEDEC STANDARD MO-252 VARIATION UAAD
2. DIMENSIONS ARE IN MILLIMETERS
3. DRAWING CONFORMS TO ASME Y14.5M-2009
4. PIN ONE IDENTIFIER IS 2X LENGTH OF ANY OTHER LINE IN THE MARK CODE LAYOUT.

<b>DOCUMENT NUMBER:</b>	<b>98AON13590G</b>	Electronic versions are uncontrolled except when accessed directly from the Document Repository. Printed versions are uncontrolled except when stamped "CONTROLLED COPY" in red.
<b>DESCRIPTION:</b>	<b>SIP6 1.45X1.0</b>	<b>PAGE 1 OF 1</b>

ON Semiconductor and are trademarks of Semiconductor Components Industries, LLC dba ON Semiconductor or its subsidiaries in the United States and/or other countries. ON Semiconductor reserves the right to make changes without further notice to any products herein. ON Semiconductor makes no warranty, representation or guarantee regarding the suitability of its products for any particular purpose, nor does ON Semiconductor assume any liability arising out of the application or use of any product or circuit, and specifically disclaims any and all liability, including without limitation special, consequential or incidental damages. ON Semiconductor does not convey any license under its patent rights nor the rights of others.

# MECHANICAL CASE OUTLINE

## PACKAGE DIMENSIONS

ON Semiconductor®

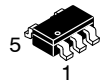

SCALE 2:1

### SC-74A CASE 318BQ ISSUE B

DATE 18 JAN 2018

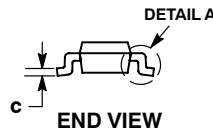
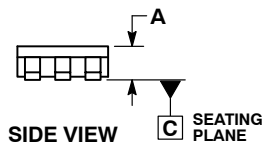
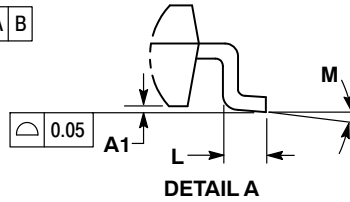
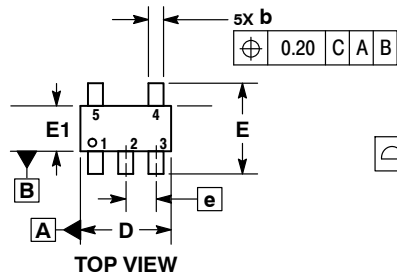

NOTES:

1. DIMENSIONING AND TOLERANCING PER ASME Y14.5M, 1994.
2. CONTROLLING DIMENSION: MILLIMETERS.
3. MAXIMUM LEAD THICKNESS INCLUDES LEAD FINISH THICKNESS. MINIMUM LEAD THICKNESS IS THE MINIMUM THICKNESS OF BASE MATERIAL.
4. DIMENSIONS A AND B DO NOT INCLUDE MOLD FLASH, PROTRUSIONS, OR GATE BURRS. MOLD FLASH, PROTRUSIONS, OR GATE BURRS SHALL NOT EXCEED 0.15 PER SIDE.

DIM	MILLIMETERS	
	MIN	MAX
A	0.90	1.10
A1	0.01	0.10
b	0.25	0.50
c	0.10	0.26
D	2.85	3.15
E	2.50	3.00
E1	1.35	1.65
e	0.95 BSC	
L	0.20	0.60
M	0°	10°

#### RECOMMENDED SOLDERING FOOTPRINT\*

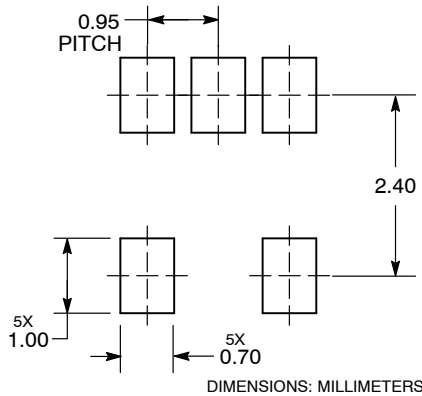

#### GENERIC MARKING DIAGRAM\*

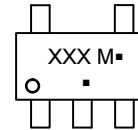

- XXX = Specific Device Code
- M = Date Code
- = Pb-Free Package

(Note: Microdot may be in either location)

\*This information is generic. Please refer to device data sheet for actual part marking. Pb-Free indicator, "G" or microdot "▪", may or may not be present. Some products may not follow the Generic Marking.

\*For additional information on our Pb-Free strategy and soldering details, please download the ON Semiconductor Soldering and Mounting Techniques Reference Manual, SOLDERRM/D.

<b>DOCUMENT NUMBER:</b>	<b>98AON66279G</b>	Electronic versions are uncontrolled except when accessed directly from the Document Repository. Printed versions are uncontrolled except when stamped "CONTROLLED COPY" in red.
<b>DESCRIPTION:</b>	<b>SC-74A</b>	<b>PAGE 1 OF 1</b>

ON Semiconductor and are trademarks of Semiconductor Components Industries, LLC dba ON Semiconductor or its subsidiaries in the United States and/or other countries. ON Semiconductor reserves the right to make changes without further notice to any products herein. ON Semiconductor makes no warranty, representation or guarantee regarding the suitability of its products for any particular purpose, nor does ON Semiconductor assume any liability arising out of the application or use of any product or circuit, and specifically disclaims any and all liability, including without limitation special, consequential or incidental damages. ON Semiconductor does not convey any license under its patent rights nor the rights of others.

# MECHANICAL CASE OUTLINE PACKAGE DIMENSIONS



SCALE 2:1

## SC-88A (SC-70-5/SOT-353) CASE 419A-02 ISSUE M

DATE 11 APR 2023

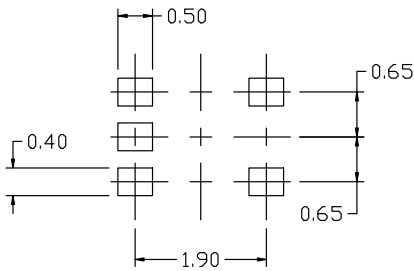
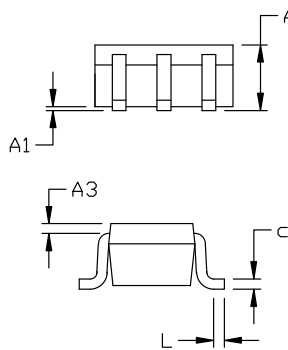
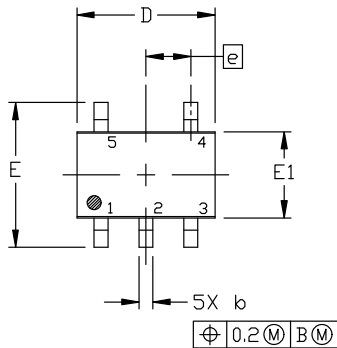

### RECOMMENDED MOUNTING FOOTPRINT

\* For additional information on our Pb-Free strategy and soldering details, please download the ON Semiconductor Soldering and Mounting Techniques Reference Manual, SOLDERM/D.

### NOTES:

1. DIMENSIONING AND TOLERANCING PER ANSI Y14.5M, 1982.
2. CONTROLLING DIMENSION: MILLIMETERS
3. 419A-01 OBSOLETE. NEW STANDARD 419A-02
4. DIMENSIONS D AND E1 DO NOT INCLUDE MOLD FLASH, PROTRUSIONS, OR GATE BURRS. MOLD FLASH, PROTRUSIONS, OR GATE BURRS SHALL NOT EXCEED 0.1016MM PER SIDE.

DIM	MILLIMETERS		
	MIN.	NOM.	MAX.
A	0.80	0.95	1.10
A1	---	---	0.10
A3	0.20 REF		
b	0.10	0.20	0.30
c	0.10	---	0.25
D	1.80	2.00	2.20
E	2.00	2.10	2.20
E1	1.15	1.25	1.35
e	0.65 BSC		
L	0.10	0.15	0.30

### GENERIC MARKING DIAGRAM\*

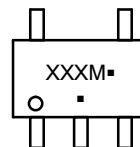

\*This information is generic. Please refer to device data sheet for actual part marking. Pb-Free indicator, "G" or microdot "▪", may or may not be present. Some products may not follow the Generic Marking.

XXX = Specific Device Code

M = Date Code

▪ = Pb-Free Package

(Note: Microdot may be in either location)

#### STYLE 1:

- PIN 1. BASE
- EMITTER
- BASE
- COLLECTOR
- COLLECTOR

#### STYLE 2:

- PIN 1. ANODE
- EMITTER
- BASE
- COLLECTOR
- CATHODE

#### STYLE 3:

- PIN 1. ANODE 1
- N/C
- ANODE 2
- CATHODE 2
- CATHODE 1

#### STYLE 4:

- PIN 1. SOURCE 1
- DRAIN 1/2
- SOURCE 1
- GATE 1
- GATE 2

#### STYLE 5:

- PIN 1. CATHODE
- COMMON ANODE
- CATHODE 2
- CATHODE 3
- CATHODE 4

#### STYLE 6:

- PIN 1. EMITTER 2
- BASE 2
- EMITTER 1
- COLLECTOR
- COLLECTOR 2/BASE 1

#### STYLE 7:

- PIN 1. BASE
- EMITTER
- BASE
- COLLECTOR
- COLLECTOR

#### STYLE 8:

- PIN 1. CATHODE
- COLLECTOR
- N/C
- BASE
- EMITTER

#### STYLE 9:

- PIN 1. ANODE
- CATHODE
- ANODE
- ANODE
- ANODE

Note: Please refer to datasheet for style callout. If style type is not called out in the datasheet refer to the device datasheet pinout or pin assignment.

<b>DOCUMENT NUMBER:</b>	<b>98ASB42984B</b>	Electronic versions are uncontrolled except when accessed directly from the Document Repository. Printed versions are uncontrolled except when stamped "CONTROLLED COPY" in red.
<b>DESCRIPTION:</b>	<b>SC-88A (SC-70-5/SOT-353)</b>	<b>PAGE 1 OF 1</b>

onsemi and ONSEMI are trademarks of Semiconductor Components Industries, LLC dba onsemi or its subsidiaries in the United States and/or other countries. onsemi reserves the right to make changes without further notice to any products herein. onsemi makes no warranty, representation or guarantee regarding the suitability of its products for any particular purpose, nor does onsemi assume any liability arising out of the application or use of any product or circuit, and specifically disclaims any and all liability, including without limitation special, consequential or incidental damages. onsemi does not convey any license under its patent rights nor the rights of others.

# MECHANICAL CASE OUTLINE PACKAGE DIMENSIONS

ON Semiconductor®

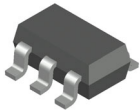

## SOT-23, 5 Lead CASE 527AH ISSUE A

DATE 09 JUN 2021

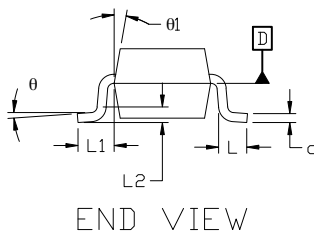
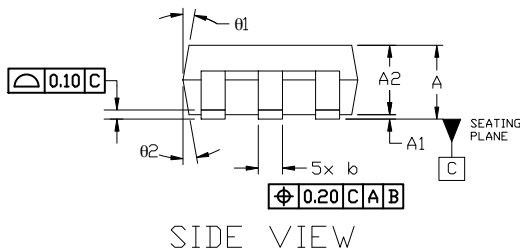
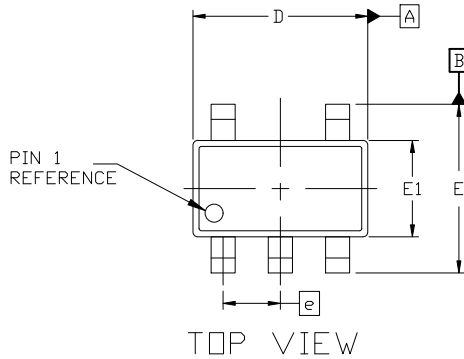

### GENERIC MARKING DIAGRAM\*

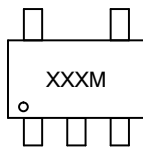

XXX = Specific Device Code  
M = Date Code

\*This information is generic. Please refer to device data sheet for actual part marking. Pb-Free indicator, "G" or microdot "•", may or may not be present. Some products may not follow the Generic Marking.

### NOTES:

1. DIMENSIONING AND TOLERANCING PER ASME Y14.5M, 1989A
2. CONTROLLING DIMENSION: MILLIMETERS
3. MAXIMUM LEAD THICKNESS INCLUDES LEAD FINISH THICKNESS. MINIMUM LEAD THICKNESS IS THE MINIMUM THICKNESS OF THE BASE MATERIAL.
4. DIMENSIONS D AND E1 DO NOT INCLUDE MOLD FLASH, PROTRUSIONS, OR GATE BURRS. MOLD FLASH, PROTRUSIONS, OR GATE BURRS SHALL NOT EXCEED 0.25 PER SIDE. D AND E1 DIMENSIONS ARE DETERMINED AT DATUM D.
5. DIMENSION 'b' DOES NOT INCLUDE DAMBAR PROTRUSION. ALLOWABLE DAMBAR PROTRUSION SHALL BE 0.08mm TOTAL IN EXCESS OF THE 'b' DIMENSION AT MAXIMUM MATERIAL CONDITION. MINIMUM SPACE BETWEEN PROTRUSION AND AN ADJACENT LEAD SHALL NOT BE LESS THAN 0.07mm.

DIM	MILLIMETERS		
	MIN.	NOM.	MAX.
A	0.90	—	1.45
A1	0.00	—	0.15
A2	0.90	1.15	1.30
b	0.30	—	0.50
c	0.08	—	0.22
D	2.90 BSC		
E	2.80 BSC		
E1	1.60 BSC		
e	0.95 BSC		
L	0.30	0.45	0.60
L1	0.60 REF		
L2	0.25 REF		
θ	0°	4°	8°
θ1	0°	10°	15°
θ2	0°	10°	15°

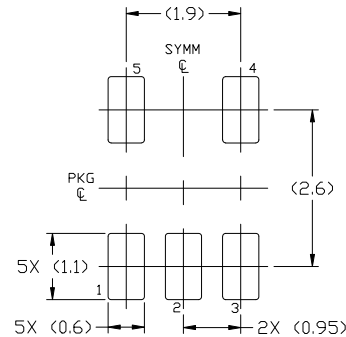

**RECOMMENDED MOUNTING FOOTPRINT**  
For additional information on our Pb-Free strategy and soldering details, please download the ON Semiconductor Soldering and Mounting Techniques Reference Manual, SOLDERRM/D.

<b>DOCUMENT NUMBER:</b>	<b>98AON34320E</b>	Electronic versions are uncontrolled except when accessed directly from the Document Repository. Printed versions are uncontrolled except when stamped "CONTROLLED COPY" in red.
<b>DESCRIPTION:</b>	<b>SOT-23, 5 LEAD</b>	<b>PAGE 1 OF 1</b>

ON Semiconductor and ON are trademarks of Semiconductor Components Industries, LLC dba ON Semiconductor or its subsidiaries in the United States and/or other countries. ON Semiconductor reserves the right to make changes without further notice to any products herein. ON Semiconductor makes no warranty, representation or guarantee regarding the suitability of its products for any particular purpose, nor does ON Semiconductor assume any liability arising out of the application or use of any product or circuit, and specifically disclaims any and all liability, including without limitation special, consequential or incidental damages. ON Semiconductor does not convey any license under its patent rights nor the rights of others.



**onsemi**, **Onsemi**, and other names, marks, and brands are registered and/or common law trademarks of Semiconductor Components Industries, LLC dba "**onsemi**" or its affiliates and/or subsidiaries in the United States and/or other countries. **onsemi** owns the rights to a number of patents, trademarks, copyrights, trade secrets, and other intellectual property. A listing of **onsemi**'s product/patent coverage may be accessed at [www.onsemi.com/site/pdf/Patent-Marking.pdf](http://www.onsemi.com/site/pdf/Patent-Marking.pdf). **onsemi** reserves the right to make changes at any time to any products or information herein, without notice. The information herein is provided "as-is" and **onsemi** makes no warranty, representation or guarantee regarding the accuracy of the information, product features, availability, functionality, or suitability of its products for any particular purpose, nor does **onsemi** assume any liability arising out of the application or use of any product or circuit, and specifically disclaims any and all liability, including without limitation special, consequential or incidental damages. Buyer is responsible for its products and applications using **onsemi** products, including compliance with all laws, regulations and safety requirements or standards, regardless of any support or applications information provided by **onsemi**. "Typical" parameters which may be provided in **onsemi** data sheets and/or specifications can and do vary in different applications and actual performance may vary over time. All operating parameters, including "Typicals" must be validated for each customer application by customer's technical experts. **onsemi** does not convey any license under any of its intellectual property rights nor the rights of others. **onsemi** products are not designed, intended, or authorized for use as a critical component in life support systems or any FDA Class 3 medical devices or medical devices with a same or similar classification in a foreign jurisdiction or any devices intended for implantation in the human body. Should Buyer purchase or use **onsemi** products for any such unintended or unauthorized application, Buyer shall indemnify and hold **onsemi** and its officers, employees, subsidiaries, affiliates, and distributors harmless against all claims, costs, damages, and expenses, and reasonable attorney fees arising out of, directly or indirectly, any claim of personal injury or death associated with such unintended or unauthorized use, even if such claim alleges that **onsemi** was negligent regarding the design or manufacture of the part. **onsemi** is an Equal Opportunity/Affirmative Action Employer. This literature is subject to all applicable copyright laws and is not for resale in any manner.

---

## ADDITIONAL INFORMATION

### TECHNICAL PUBLICATIONS:

Technical Library: [www.onsemi.com/design/resources/technical-documentation](http://www.onsemi.com/design/resources/technical-documentation)  
onsemi Website: [www.onsemi.com](http://www.onsemi.com)

### ONLINE SUPPORT: [www.onsemi.com/support](http://www.onsemi.com/support)

For additional information, please contact your local Sales Representative at [www.onsemi.com/support/sales](http://www.onsemi.com/support/sales)