

NB7V586M

1.8V Differential 2:1 Mux Input to 1.2V/1.8V 1:6 CML Clock/Data Fanout Buffer / Translator

Multi-Level Inputs w/ Internal Termination

Description

The NB7V586M is a differential 1-to-6 CML Clock/Data Distribution chip featuring a 2:1 Clock/Data input multiplexer with an input select pin. The IN_x/\overline{IN}_x inputs incorporate internal 50 Ω termination resistors and will accept differential LVPECL, CML, or LVDS logic levels (see Figure 12). The IN_x/\overline{IN}_x inputs and core logic are powered with a 1.8 V supply. The NB7V586M produces six identical differential CML output copies of Clock or Data. The outputs are configured as three banks of two differential pair. Each bank (or all three banks) have the flexibility of being powered by any combination of either a 1.8 V or 1.2 V supply.

The 16 mA differential CML output structure provides matching internal 50 Ω source terminations and 400 mV output swings when externally terminated with a 50 Ω resistor to V_{CCOX} (see Figure 11).

The 1:6 fanout design was optimized for low output skew and minimal jitter and is ideal for SONET, GigE, Fiber Channel, Backplane and other Clock/Data distribution applications operating up to 6 GHz or 10 Gb/s typical. The V_{REFAC} reference outputs can be used to bias capacitor-coupled differential or single-ended input signals.

The NB7V586M is offered in a low profile 5x5 mm 32-pin Pb-Free QFN package. Application notes, models, and support documentation are available at www.onsemi.com.

The NB7V586M is a member of the GigaComm™ family of high performance clock products.

Features

- Maximum Input Data Rate > 10 Gb/s Typical
- Data Dependent Jitter < 10 ps
- Maximum Input Clock Frequency > 6 GHz Typical
- Random Clock Jitter < 0.8 ps RMS, Max
- Low Skew 1:6 CML Outputs, 20 ps Max
- 2:1 Multi-Level Mux Inputs
- 175 ps Typical Propagation Delay
- 50 ps Typical Rise and Fall Times
- Differential CML Outputs, 330 mV Peak-to-Peak, Typical
- Operating Range: $V_{CC} = 1.71$ V to 1.89 V
- Operating Range: $V_{CCOX} = 1.14$ V to 1.89 V
- Internal 50 Ω Input Termination Resistors
- V_{REFAC} Reference Output
- QFN32 Package, 5 mm x 5 mm
- -40°C to +85°C Ambient Operating Temperature
- These are Pb-Free Devices



ON Semiconductor®

<http://onsemi.com>

MARKING DIAGRAM*

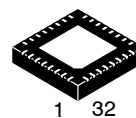

QFN32
MN SUFFIX
CASE 488AM

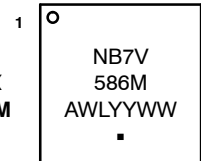

A = Assembly Location
WL = Wafer Lot
YY = Year
WW = Work Week
G or ■ = Pb-Free Package

*For additional marking information, refer to Application Note AND8002/D.

SIMPLIFIED LOGIC DIAGRAM

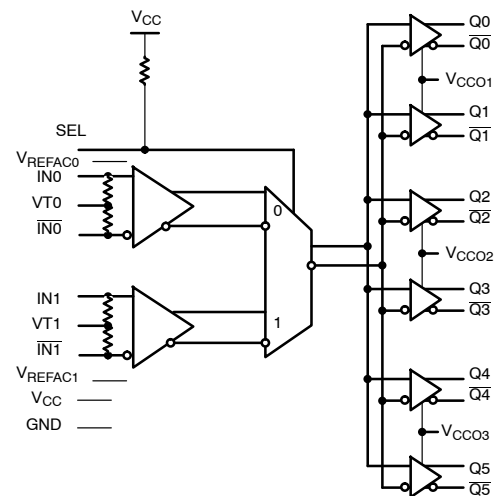

ORDERING INFORMATION

See detailed ordering and shipping information in the package dimensions section on page 7 of this data sheet.

NB7V586M

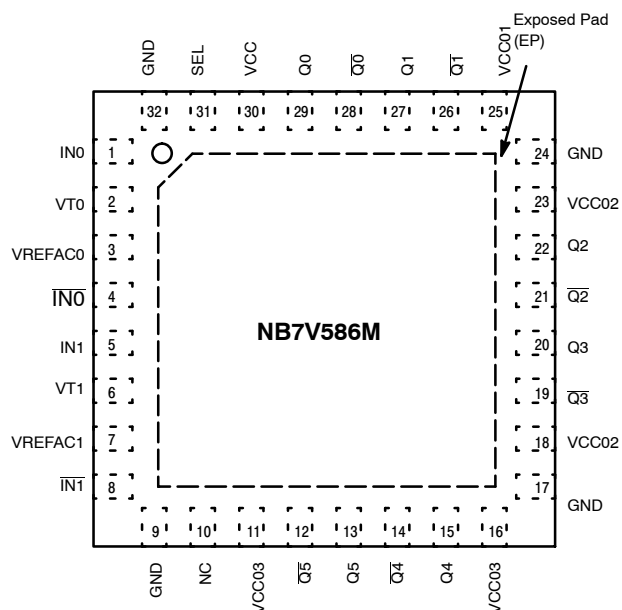

Figure 1. 32-Lead QFN Pinout (Top View)

Table 1. INPUT SELECT FUNCTION TABLE

SEL*	CLK Input Selected
0	IN0
1	IN1

*Defaults HIGH when left open.

Table 2. PIN DESCRIPTION

Pin	Name	I/O	Description
1,4 5,8	IN0, $\overline{\text{IN0}}$ IN1, $\overline{\text{IN1}}$	LVPECL, CML, LVDS Input	Non-inverted, Inverted, Differential Inputs
2,6	VT0, VT1		Internal 100 Ω Center-tapped Termination Pin for IN0/ $\overline{\text{IN0}}$ and IN1/ $\overline{\text{IN1}}$
31	SEL	LVTTTL/LVCMOS Input	Input Select pin; LOW for IN0 Inputs, HIGH for IN1 Inputs; defaults HIGH when left open
10	NC	–	No Connect
30	VCC	–	1.8 V Positive Supply Voltage for the Inputs and Core Logic.
25	VCCO1	–	1.2 V or 1.8 V Positive Supply Voltage for the Q0, $\overline{\text{Q0}}$, Q1, $\overline{\text{Q1}}$ CML Outputs
18, 23	VCCO2	–	1.2 V or 1.8 V Positive Supply Voltage for the Q2, $\overline{\text{Q2}}$, Q3, $\overline{\text{Q3}}$ CML Outputs
11, 16	VCCO3	–	1.2 V or 1.8 V Positive Supply Voltage for the Q4, $\overline{\text{Q4}}$, Q5, $\overline{\text{Q5}}$ CML Outputs
29, 28 27, 26	Q0, $\overline{\text{Q0}}$ Q1, $\overline{\text{Q1}}$	1.2 V or 1.8 V CML Output	Non-inverted, Inverted Differential Outputs; powered by VCCO1 (Notes 1 and 2).
22, 21 20, 19	Q2, $\overline{\text{Q2}}$ Q3, $\overline{\text{Q3}}$	1.2 V or 1.8 V CML Output	Non-inverted, Inverted Differential Outputs; powered by VCCO2 (Notes 1 and 2).
15, 14 13, 12	Q4, $\overline{\text{Q4}}$ Q5, $\overline{\text{Q5}}$	1.2 V or 1.8 V CML Output	Non-inverted, Inverted Differential Outputs; powered by VCCO3 (Notes 1 and 2).
9, 17, 24, 32	GND	–	Negative Supply Voltage, connected to Ground
3 7	VREFAC0 VREFAC1	–	Output Voltage Reference for Capacitor-Coupled Inputs, only
–	EP	–	The Exposed Pad (EP) on the QFN-32 package bottom is thermally connected to the die for improved heat transfer out of package. The exposed pad must be attached to a heat-sinking conduit. The pad is electrically connected to the die, and must be electrically and thermally connected to GND on the PC board.

1. In the differential configuration when the input termination pins (VT0, VT1) are connected to a common termination voltage or left open, and if no signal is applied on INn/ $\overline{\text{INn}}$ input, then, the device will be susceptible to self-oscillation. Qn/ $\overline{\text{Qn}}$ outputs have internal 50 Ω source termination resistors.
2. All V_{CC}, VCC0x and GND pins must be externally connected to a power supply for proper operation.

NB7V586M

Table 3. ATTRIBUTES

Characteristics		Value
ESD Protection	Human Body Model Machine Model	> 2 kV > 200 V
Input Pullup Resistor (R _{PU})		75 kΩ
Moisture Sensitivity (Note 3)		Level 1
Flammability Rating	Oxygen Index: 28 to 34	UL 94 V-0 @ 0.125 in
Transistor Count		308
Meets or exceeds JEDEC Spec EIA/JESD78 IC Latchup Test		

3. For additional information, see Application Note AND8003/D.

Table 4. MAXIMUM RATINGS

Symbol	Parameter	Condition 1	Condition 2	Rating	Unit
V _{CC}	Positive Power Supply	GND = 0 V		3.0	V
V _{CCOx}	Positive Power Supply	GND = 0 V		3.0	V
V _{IO}	Input/Output Voltage	GND = 0 V	$-0.5 \leq V_{IO} \leq V_{CC} + 0.5$	-0.5 to V _{CC} + 0.5	V
V _{INPP}	Differential Input Voltage $ I_{N_x} - \overline{I_{N_x}} $			1.89	V
I _{IN}	Input Current Through R _T (50 Ω Resistor)			± 40	mA
I _{OUT}	Output Current	Continuous Surge		34 40	mA
I _{VREFAC}	V _{REFAC} Sink/Source Current			± 1.5	mA
T _A	Operating Temperature Range			-40 to +85	°C
T _{stg}	Storage Temperature Range			-65 to +150	°C
θ _{JA}	Thermal Resistance (Junction-to-Ambient) (Note 4)	0 lfpm 500 lfpm	QFN-32 QFN-32	31 27	°C/W °C/W
θ _{JC}	Thermal Resistance (Junction-to-Case) (Note 4)	Standard Board	QFN-32	12	°C/W
T _{sol}	Wave Solder Pb-Free			265	°C

Stresses exceeding Maximum Ratings may damage the device. Maximum Ratings are stress ratings only. Functional operation above the Recommended Operating Conditions is not implied. Extended exposure to stresses above the Recommended Operating Conditions may affect device reliability.

4. JEDEC standard multilayer board – 2S2P (2 signal, 2 power) with 8 filled thermal vias under exposed pad.

NB7V586M

Table 5. DC CHARACTERISTICS – CML OUTPUT $V_{CC} = 1.8\text{ V} \pm 5\%$, $V_{CCO1} = 1.2\text{ V} \pm 5\%$ or $1.8\text{ V} \pm 5\%$, $V_{CCO2} = 1.2\text{ V} \pm 5\%$ or $1.8\text{ V} \pm 5\%$, $V_{CCO3} = 1.2\text{ V} \pm 5\%$ or $1.8\text{ V} \pm 5\%$, $GND = 0\text{ V}$, $T_A = -40^\circ\text{C}$ to 85°C (Note 5)

Symbol	Characteristic	Min	Typ	Max	Unit
--------	----------------	-----	-----	-----	------

POWER SUPPLY CURRENT (Inputs and Outputs open)

I_{CC}	Power Supply Current for V_{CC} (Inputs and Outputs Open)		75	125	mA
I_{CCO}	Power Supply Current for V_{CCOx} (Inputs and Outputs Open)		95	105	

CML OUTPUTS (Note 6)

V_{OH}	Output HIGH Voltage $V_{CC} = 1.8\text{ V}$, $V_{CCOx} = 1.8\text{ V}$ $V_{CC} = 1.8\text{ V}$, $V_{CCOx} = 1.2\text{ V}$	$V_{CCOx} - 40$ 1760 1160	$V_{CCOx} - 20$ 1780 1180	V_{CCOx} 1800 1200	mV
V_{OL}	Output LOW Voltage $V_{CC} = 1.8\text{ V}$, $V_{CCOx} = 1.8\text{ V}$ $V_{CC} = 1.8\text{ V}$, $V_{CCOx} = 1.2\text{ V}$	$V_{CCOx} - 500$ 1300 700	$V_{CCOx} - 400$ 1400 800	$V_{CCOx} - 275$ 1525 925	mV

DIFFERENTIAL INPUTS DRIVEN SINGLE-ENDED (Note 7) (Figure 6)

V_{th}	Input Threshold Reference Voltage Range (Note 8)	1050		$V_{CC} - 100$	mV
V_{IH}	Single-Ended Input HIGH Voltage	$V_{th} + 100$		V_{CC}	mV
V_{IL}	Single-Ended Input LOW Voltage	GND		$V_{th} - 100$	mV
V_{ISE}	Single-Ended Input Voltage ($V_{IH} - V_{IL}$)	200		1200	mV

V_{REFAC}

V_{REFAC}	Output Reference Voltage @ 100 μA for Capacitor – Coupled Inputs, Only	$V_{CC} - 550$	$V_{CC} - 450$	$V_{CC} - 300$	mV
-------------	---	----------------	----------------	----------------	----

DIFFERENTIAL INPUTS DRIVEN DIFFERENTIALLY (Note 9) (Figures 4 and 7)

V_{IHD}	Differential Input HIGH Voltage (I_N, \bar{I}_N)	1100		V_{CC}	mV
V_{ILD}	Differential Input LOW Voltage (I_N, \bar{I}_N)	GND		$V_{CC} - 100$	mV
V_{ID}	Differential Input Voltage (I_N, \bar{I}_N) ($V_{IHD} - V_{ILD}$)	100		1200	mV
V_{CMR}	Input Common Mode Range (Differential Configuration, Note 10) (Figure 9)	1050		$V_{CC} - 50$	mV
I_{IH}	Input HIGH Current I_N/\bar{I}_N (V_{TO} / V_{T1} Open)	-150		150	μA
I_{IL}	Input LOW Current I_N/\bar{I}_N (V_{TO} / V_{T1} Open)	-150		150	μA

CONTROL INPUT (SEL Pin)

V_{IH}	Input HIGH Voltage for Control Pin	$V_{CC} \times 0.65$		V_{CC}	mV
V_{IL}	Input LOW Voltage for Control Pin	GND		$V_{CC} \times 0.35$	mV
I_{IH}	Input HIGH Current	-150	20	+150	μA
I_{IL}	Input LOW Current	-150	5	+150	μA

TERMINATION RESISTORS

R_{TIN}	Internal Input Termination Resistor (Measured from I_N to V_{Tx})	45	50	55	Ω
R_{TOUT}	Internal Output Termination Resistor	45	50	55	Ω

NOTE: Device will meet the specifications after thermal equilibrium has been established when mounted in a test socket or printed circuit board with maintained transverse airflow greater than 500 lpm. Electrical parameters are guaranteed only over the declared operating temperature range. Functional operation of the device exceeding these conditions is not implied. Device specification limit values are applied individually under normal operating conditions and not valid simultaneously.

- Input parameters vary 1:1 with V_{CC} . and output parameters vary 1:1 with V_{CCOx} .
- CML outputs (Q_n/\bar{Q}_n) have internal 50 Ω source termination resistors and must be externally terminated with 50 Ω to V_{CCOx} for proper operation.
- V_{th} , V_{IH} , V_{IL} and V_{ISE} parameters must be complied with simultaneously.
- V_{th} is applied to the complementary input when operating in single-ended mode.
- V_{IHD} , V_{ILD} , V_{ID} and V_{CMR} parameters must be complied with simultaneously.
- V_{CMR} min varies 1:1 with GND, V_{CMR} max varies 1:1 with V_{CC} . The V_{CMR} range is referenced to the most positive side of the differential input signal.

NB7V586M

Table 6. AC CHARACTERISTICS $V_{CC} = 1.8\text{ V} \pm 5\%$, $V_{CCO1} = 1.2\text{ V} \pm 5\%$ or $1.8\text{ V} \pm 5\%$, $V_{CCO2} = 1.2\text{ V} \pm 5\%$ or $1.8\text{ V} \pm 5\%$, $V_{CCO3} = 1.2\text{ V} \pm 5\%$ or $1.8\text{ V} \pm 5\%$, $GND = 0\text{ V}$, $T_A = -40^\circ\text{C}$ to 85°C (Note 11)

Symbol	Characteristic	Min	Typ	Max	Unit
f_{MAX}	Maximum Input Clock Frequency, $V_{OUTPP} \geq 200\text{ mV}$	4.0	6.0		GHz
$f_{DATAMAX}$	Maximum Operating Input Data Rate (PRBS23)	10			Gbps
V_{OUTPP}	Output Voltage Amplitude (See Figures 4, Note 15) $f_{in} \leq 4.0\text{ GHz}$	200	330		mV
t_{PLH}, t_{PHL}	Propagation Delay to Output Differential @ 1 GHz, IN_x/\overline{IN}_x to Q_n/\overline{Q}_n Measured at Differential Crosspoint SEL to Q_n	125 125	175	250 300	ps
$t_{PLH\ TC}$	Propagation Delay Temperature Coefficient		100		fs/°C
t_{SKEW}	Output – Output Skew (Within Device) (Note 12) Device – Device Skew ($t_{pd\ Max} - t_{pd\ min}$)			30 50	ps
t_{DC}	Output Clock Duty Cycle (Reference Duty Cycle = 50%) $f_{in} \leq 4.0\text{ GHz}$	45	50	55	%
t_{JITTER}	Output Random Jitter (RJ) (Note 13) $f_{in} \leq 4.0\text{ GHz}$ Deterministic Jitter (DJ) (Note 14) 10 Gbps		0.2	0.8 10	ps rms ps pk-pk
V_{INPP}	Input Voltage Swing (Differential Configuration) (Note 15)	100		1200	mV
t_r, t_f	Output Rise/Fall Times @ 1 GHz (20% – 80%) Q_n, \overline{Q}_n		50	65	ps

NOTE: Device will meet the specifications after thermal equilibrium has been established when mounted in a test socket or printed circuit board with maintained transverse airflow greater than 500 lpm. Electrical parameters are guaranteed only over the declared operating temperature range. Functional operation of the device exceeding these conditions is not implied. Device specification limit values are applied individually under normal operating conditions and not valid simultaneously.

11. Measured using a 400 mV source, 50% duty cycle clock source. All outputs must be loaded with external $50\ \Omega$ to V_{CCOx} . Input edge rates 40 ps (20% – 80%).
12. Skew is measured between outputs under identical transitions and conditions. Duty cycle skew is defined only for differential operation when the delays are measured from cross-point of the inputs to the crosspoint of the outputs.
13. Additive RMS jitter with 50% duty cycle clock signal.
14. Additive Peak-to-Peak data dependent jitter with input NRZ data at PRBS23.
15. Input and output voltage swing is a single-ended measurement operating in differential mode.

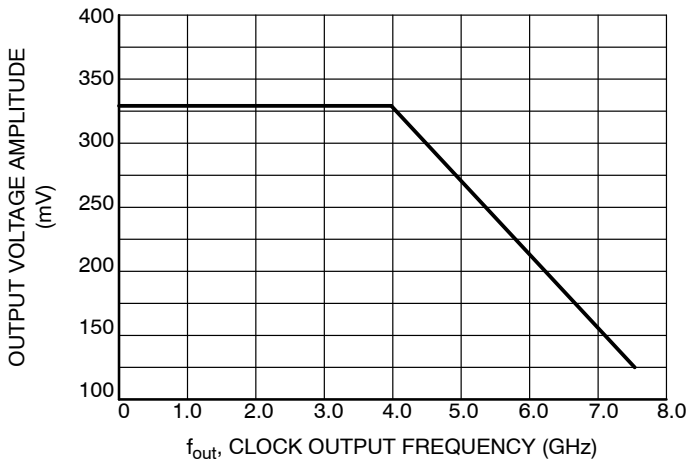

Figure 2. Output Voltage Amplitude (V_{OUTPP}) vs. Input Frequency (f_{in}) at Ambient Temperature (Typical)

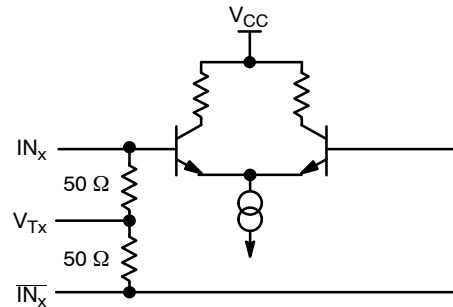

Figure 3. Input Structure

NB7V586M

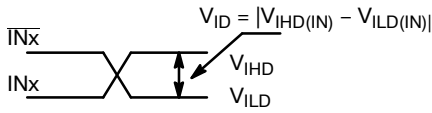

Figure 4. Differential Inputs Driven Differentially

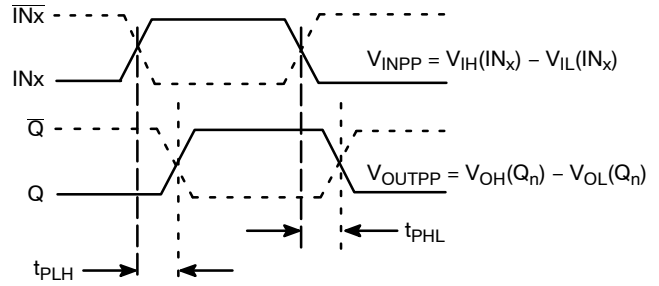

Figure 5. AC Reference Measurement

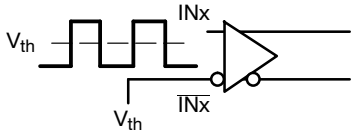

Figure 6. Differential Input Driven Single-Ended

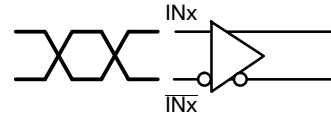

Figure 7. Differential Inputs Driven Differentially

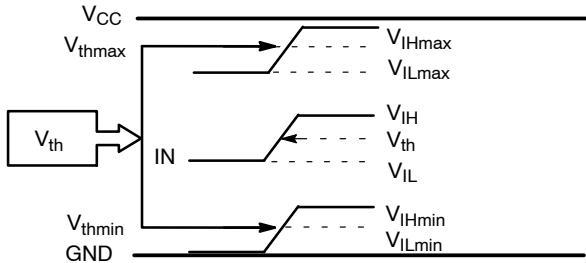

Figure 8. V_{th} Diagram

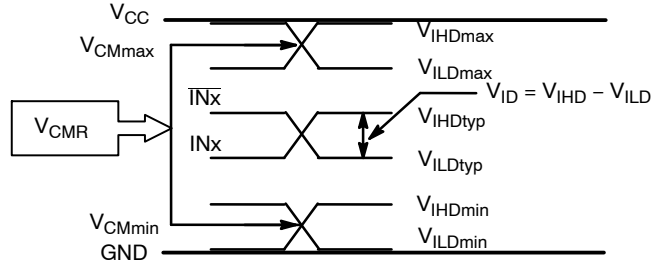

Figure 9. V_{CM} Diagram

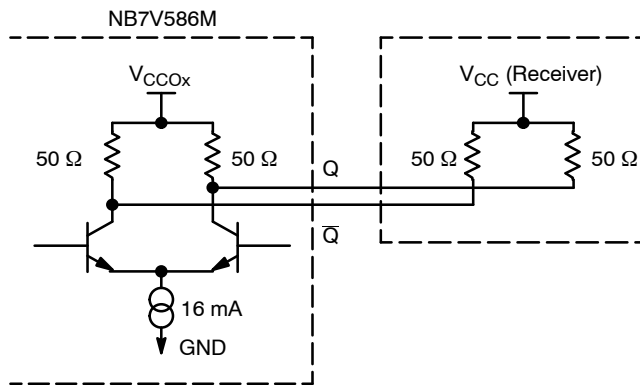
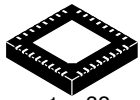

Figure 10. Typical CML Output Structure and Termination

MECHANICAL CASE OUTLINE

PACKAGE DIMENSIONS

ON Semiconductor®



1 32

SCALE 2:1

QFN32 5x5, 0.5P
CASE 488AM
ISSUE A

DATE 23 OCT 2013

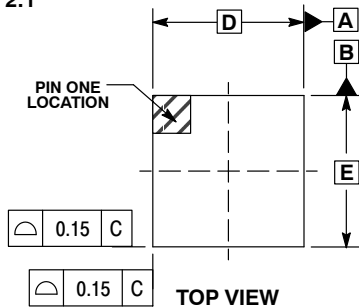

TOP VIEW

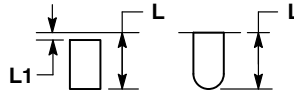

DETAIL A
ALTERNATE TERMINAL
CONSTRUCTIONS

NOTES:

1. DIMENSIONS AND TOLERANCING PER ASME Y14.5M, 1994.
2. CONTROLLING DIMENSION: MILLIMETERS.
3. DIMENSION b APPLIES TO PLATED TERMINAL AND IS MEASURED BETWEEN 0.15 AND 0.30MM FROM THE TERMINAL TIP. COPLANARITY APPLIES TO THE EXPOSED PAD AS WELL AS THE TERMINALS.
4. COPLANARITY APPLIES TO THE EXPOSED PAD AS WELL AS THE TERMINALS.

MILLIMETERS		
DIM	MIN	MAX
A	0.80	1.00
A1	---	0.05
A3	0.20	REF
b	0.18	0.30
D	5.00	BSC
D2	2.95	3.25
E	5.00	BSC
E2	2.95	3.25
e	0.50	BSC
K	0.20	---
L	0.30	0.50
L1	---	0.15

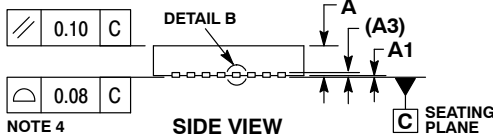

SIDE VIEW

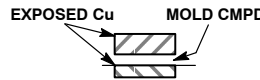

DETAIL B
ALTERNATE
CONSTRUCTION

GENERIC
MARKING DIAGRAM*

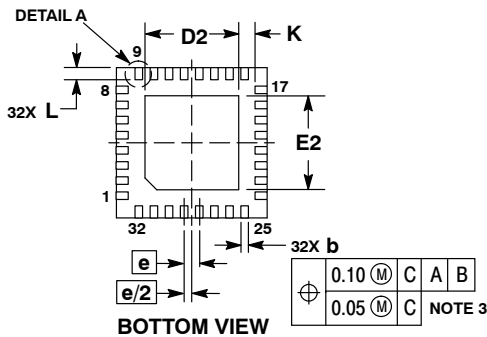

BOTTOM VIEW

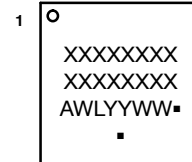

- XXXXX = Specific Device Code
- A = Assembly Location
- WL = Wafer Lot
- YY = Year
- WW = Work Week
- = Pb-Free Package

(Note: Microdot may be in either location)

*This information is generic. Please refer to device data sheet for actual part marking.
Pb-Free indicator, "G" or microdot "▪", may or may not be present.

RECOMMENDED
SOLDERING FOOTPRINT*

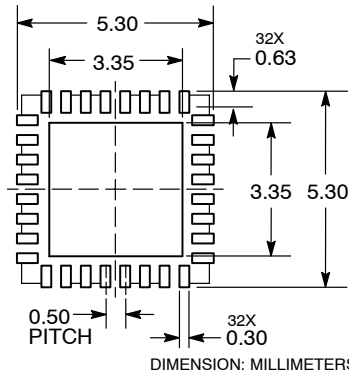

*For additional information on our Pb-Free strategy and soldering details, please download the ON Semiconductor Soldering and Mounting Techniques Reference Manual, SOLDERRM/D.

DOCUMENT NUMBER:	98AON20032D	Electronic versions are uncontrolled except when accessed directly from the Document Repository. Printed versions are uncontrolled except when stamped "CONTROLLED COPY" in red.
DESCRIPTION:	QFN32 5x5 0.5P	PAGE 1 OF 1

ON Semiconductor and ON are trademarks of Semiconductor Components Industries, LLC dba ON Semiconductor or its subsidiaries in the United States and/or other countries. ON Semiconductor reserves the right to make changes without further notice to any products herein. ON Semiconductor makes no warranty, representation or guarantee regarding the suitability of its products for any particular purpose, nor does ON Semiconductor assume any liability arising out of the application or use of any product or circuit, and specifically disclaims any and all liability, including without limitation special, consequential or incidental damages. ON Semiconductor does not convey any license under its patent rights nor the rights of others.

onsemi, **Onsemi**, and other names, marks, and brands are registered and/or common law trademarks of Semiconductor Components Industries, LLC dba "**onsemi**" or its affiliates and/or subsidiaries in the United States and/or other countries. **onsemi** owns the rights to a number of patents, trademarks, copyrights, trade secrets, and other intellectual property. A listing of **onsemi**'s product/patent coverage may be accessed at www.onsemi.com/site/pdf/Patent-Marking.pdf. **onsemi** reserves the right to make changes at any time to any products or information herein, without notice. The information herein is provided "as-is" and **onsemi** makes no warranty, representation or guarantee regarding the accuracy of the information, product features, availability, functionality, or suitability of its products for any particular purpose, nor does **onsemi** assume any liability arising out of the application or use of any product or circuit, and specifically disclaims any and all liability, including without limitation special, consequential or incidental damages. Buyer is responsible for its products and applications using **onsemi** products, including compliance with all laws, regulations and safety requirements or standards, regardless of any support or applications information provided by **onsemi**. "Typical" parameters which may be provided in **onsemi** data sheets and/or specifications can and do vary in different applications and actual performance may vary over time. All operating parameters, including "Typicals" must be validated for each customer application by customer's technical experts. **onsemi** does not convey any license under any of its intellectual property rights nor the rights of others. **onsemi** products are not designed, intended, or authorized for use as a critical component in life support systems or any FDA Class 3 medical devices or medical devices with a same or similar classification in a foreign jurisdiction or any devices intended for implantation in the human body. Should Buyer purchase or use **onsemi** products for any such unintended or unauthorized application, Buyer shall indemnify and hold **onsemi** and its officers, employees, subsidiaries, affiliates, and distributors harmless against all claims, costs, damages, and expenses, and reasonable attorney fees arising out of, directly or indirectly, any claim of personal injury or death associated with such unintended or unauthorized use, even if such claim alleges that **onsemi** was negligent regarding the design or manufacture of the part. **onsemi** is an Equal Opportunity/Affirmative Action Employer. This literature is subject to all applicable copyright laws and is not for resale in any manner.

ADDITIONAL INFORMATION

TECHNICAL PUBLICATIONS:

Technical Library: www.onsemi.com/design/resources/technical-documentation
onsemi Website: www.onsemi.com

ONLINE SUPPORT: www.onsemi.com/support

For additional information, please contact your local Sales Representative at www.onsemi.com/support/sales