

NB3N551

Clock / Data Fanout Buffer, 3.3 V 1:4, with CMOS Outputs

Description

The NB3N551 is a low skew 1-to-4 clock fanout buffer, designed for clock distribution in mind. The NB3N551 specifically guarantees low output-to-output skew. Optimal design, layout and processing minimize skew within a device and from device to device.

The output enable (OE) pin three-states the outputs when low.

Features

- Input/Output Clock Frequency up to 180 MHz
- Low Skew Outputs (50 ps typical)
- RMS Phase Jitter (12 kHz – 20 MHz): 43 fs (Typical)
- Output goes to Three-State Mode via OE
- Operating Range: $V_{DD} = 3.0\text{ V to }5.5\text{ V}$
- Ideal for Networking Clocks
- Packaged in 8-pin SOIC
- Industrial Temperature Range
- These are Pb-Free Devices

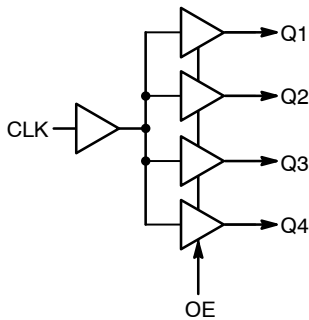

Figure 1. Block Diagram



ON Semiconductor®

<http://onsemi.com>

MARKING DIAGRAMS*



SOIC-8
D SUFFIX
CASE 751

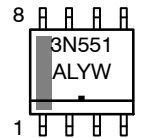

3N551 = Specific Device Code
A = Assembly Location
L = Wafer Lot
Y = Year
W = Work Week
▪ = Pb-Free Package

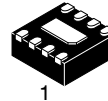

DFN8
MN SUFFIX
CASE 506AA

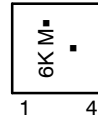

6K = Specific Device Code
M = Date Code
▪ = Pb-Free Package

(Note: Microdot may be in either location)

*For additional marking information, refer to Application Note AND8002/D.

PIN CONNECTIONS

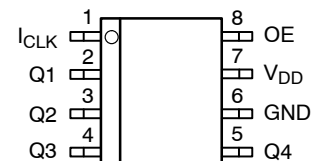

ORDERING INFORMATION

Device	Package	Shipping†
NB3N551DG	SOIC-8 (Pb-Free)	98 Units/Rail
NB3N551DR2G	SOIC-8 (Pb-Free)	2500/Tape & Reel
NB3N551MNR4G	DFN-8 (Pb-Free)	1000/Tape & Reel

†For information on tape and reel specifications, including part orientation and tape sizes, please refer to our Tape and Reel Packaging Specification Brochure, BRD8011/D.

NB3N551

Table 1. OE, OUTPUT ENABLE FUNCTION

OE	Function
0	Disable
1	Enable

Table 2. PIN DESCRIPTION

Pin #	Name	Type	Description
1	I _{CLK}	(LV)CMOS/(LV)TTL Input	Clock Input. Internal pull-up resistor.
2	Q1	(LV)CMOS/(LV)TTL Output	Clock Output 1
3	Q2	(LV)CMOS/(LV)TTL Output	Clock Output 2
4	Q3	(LV)CMOS/(LV)TTL Output	Clock Output 3
5	Q4	(LV)CMOS/(LV)TTL Output	Clock Output 4
6	GND	Power	Negative supply voltage; Connect to ground, 0 V
7	V _{DD}	Power	Positive supply voltage (3.0 V to 5.5 V)
8	OE	(LV)CMOS/(LV)TTL Input	Output Enable for the clock outputs. Outputs are enabled when HIGH or when left open; OE pin has internal pull-up resistor. Three-states outputs when LOW.
-	EP	Thermal Exposed Pad	(DFN8 only) Thermal exposed pad must be connected to a sufficient thermal conduit. Electrically connect to the most negative supply (GND) or leave unconnected, floating open.

NB3N551

Table 3. MAXIMUM RATINGS

Symbol	Parameter	Condition 1	Condition 2	Rating	Units
V _{DD}	Positive Power Supply	GND = 0 V	–	7.0	V
V _{I/O}	Input/Output Voltage	t ≤ 1.5 ns	–	GND–1.5 ≤ V _{I/O} ≤ V _{DD} +1.5	V
T _A	Operating Temperature Range, Industrial	–	–	≥ –40 to ≤ +85	°C
T _{stg}	Storage Temperature Range	–	–	–65 to +150	°C
θ _{JA}	Thermal Resistance (Junction–to–Ambient)	0 lfpm 500 lfpm	SOIC–8	190 130	°C/W °C/W
θ _{JC}	Thermal Resistance (Junction–to–Case)	(Note 1)	SOIC–8	41 to 44	°C/W
θ _{JA}	Thermal Resistance (Junction–to–Ambient)	0 lfpm 500 lfpm	DFN8 DFN8	129 84	°C/W
θ _{JC}	Thermal Resistance (Junction–to–Case)	(Note 1)	DFN8	35 to 40	°C/W

Stresses exceeding Maximum Ratings may damage the device. Maximum Ratings are stress ratings only. Functional operation above the Recommended Operating Conditions is not implied. Extended exposure to stresses above the Recommended Operating Conditions may affect device reliability.

1. JEDEC standard multilayer board – 2S2P (2 signal, 2 power)

Table 4. ATTRIBUTES

Characteristic	Value
ESD Protection	Human Body Model Machine Model > 4 kV > 200 V
Moisture Sensitivity, Indefinite Time Out of Drypack (Note 2)	Level 1
Flammability Rating	Oxygen Index: 28 to 34 UL–94 code V–0 @ 0.125 in
Transistor Count	531 Devices
Meets or Exceeds JEDEC Standard EIA/JESD78 IC Latchup Test	

2. For additional Moisture Sensitivity information, refer to Application Note AND8003/D.

NB3N551

Table 5. DC CHARACTERISTICS ($V_{DD} = 3.0\text{ V to }3.6\text{ V}$, $GND = 0\text{ V}$, $T_A = -40^\circ\text{C to }+85^\circ\text{C}$) (Note 3)

Symbol	Characteristic	Min	Typ	Max	Unit
I_{DD}	Power Supply Current @ 135 MHz, No Load, $V_{DD} = 3.3\text{ V}$	–	20	40	mA
V_{OH}	Output HIGH Voltage – $I_{OH} = -25\text{ mA}$, $V_{DD} = 3.3\text{ V}$	2.4	–	–	V
V_{OL}	Output LOW Voltage – $I_{OL} = 25\text{ mA}$	–	–	0.4	V
V_{OH}	Output HIGH Voltage – $I_{OH} = -12\text{ mA}$ (CMOS level)	$V_{DD} - 0.4$	–	–	V
V_{IH}, I_{CLK}	Input HIGH Voltage, I_{CLK}	$(V_{DD}/2)+0.7$	–	3.8	V
V_{IL}, I_{CLK}	Input LOW Voltage, I_{CLK}	–	–	$(V_{DD}/2)-0.7$	V
V_{IH}, OE	Input HIGH Voltage, OE	2.0	–	V_{DD}	V
V_{IL}, OE	Input LOW Voltage, OE	0	–	0.8	V
ZO	Nominal Output Impedance	–	20	–	Ω
RPU	Input Pull-up Resistor, OE	–	220	–	k Ω
CIN	Input Capacitance, OE	–	5.0	–	pF
IOS	Short Circuit Current	–	± 50	–	mA

DC CHARACTERISTICS ($V_{DD} = 4.5\text{ V to }5.5\text{ V}$, $GND = 0\text{ V}$, $T_A = -40^\circ\text{C to }+85^\circ\text{C}$) (Note 3)

Symbol	Characteristic	Min	Typ	Max	Unit
I_{DD}	Power Supply Current @ 135 MHz, No Load, $V_{DD} = 5.0\text{ V}$	–	50	95	mA
V_{OH}	Output HIGH Voltage – $I_{OH} = -35\text{ mA}$	2.4	–	–	V
V_{OL}	Output LOW Voltage – $I_{OL} = 35\text{ mA}$	–	–	0.4	V
V_{OH}	Output HIGH Voltage – $I_{OH} = -12\text{ mA}$ (CMOS level)	$V_{DD} - 0.4$	–	–	V
V_{IH}, I_{CLK}	Input HIGH Voltage, I_{CLK}	$(V_{DD}/2) + 1$	–	5.5	V
V_{IL}, I_{CLK}	Input LOW Voltage, I_{CLK}	–	–	$(V_{DD}/2) - 1$	V
V_{IH}, OE	Input HIGH Voltage, OE	2.0	–	V_{DD}	V
V_{IL}, OE	Input LOW Voltage, OE	0	–	0.8	V
ZO	Nominal Output Impedance	–	20	–	Ω
RPU	Input Pull-up Resistor, OE	–	220	–	k Ω
CIN	Input Capacitance, OE	–	5.0	–	pF
IOS	Short Circuit Current	–	± 80	–	mA

Table 6. AC CHARACTERISTICS ($V_{DD} = 3.0\text{ V to }5.5\text{ V}$, $GND = 0\text{ V}$, $T_A = -40^\circ\text{C to }+85^\circ\text{C}$) (Note 3)

Symbol	Characteristic	Conditions	Min	Typ	Max	Unit
f_{in}	Input Frequency		–	–	180	MHz
$t_{jitter}(\phi)$	RMS Phase Jitter (Integrated 12 kHz – 20 MHz) (See Figures 2 and 3)	$f_{carrier} = 25\text{ MHz}$ $f_{carrier} = 50\text{ MHz}$	– –	43 16	– –	fs
$t_{jitter}(pd)$	Period Jitter (RMS, 1σ)		–	2.0	–	ps
t_r/t_f	Output rise and fall times; 0.8 V to 2.0 V		–	0.5	1.0	ns
t_{pd}	Propagation Delay, CLK to Qn, 0 – 180 MHz, (Note 4)		1.5	3.0	6.0	ns
t_{skew}	Output-to-Output Skew; (Note 5)		–	50	160	ps

3. Outputs loaded with external $R_L = 33\text{-}\Omega$ series resistor and $C_L = 15\text{ pF}$ to GND. Duty cycle out = duty in. A $0.01\text{ }\mu\text{F}$ decoupling capacitor should be connected between V_{DD} and GND. A $33\text{ }\Omega$ series terminating resistor may be used on each clock output if the trace is longer than 1 inch.
4. Measured with rail-to-rail input clock.
5. Measured on rising edges at $V_{DD} + 2$.

NB3N551

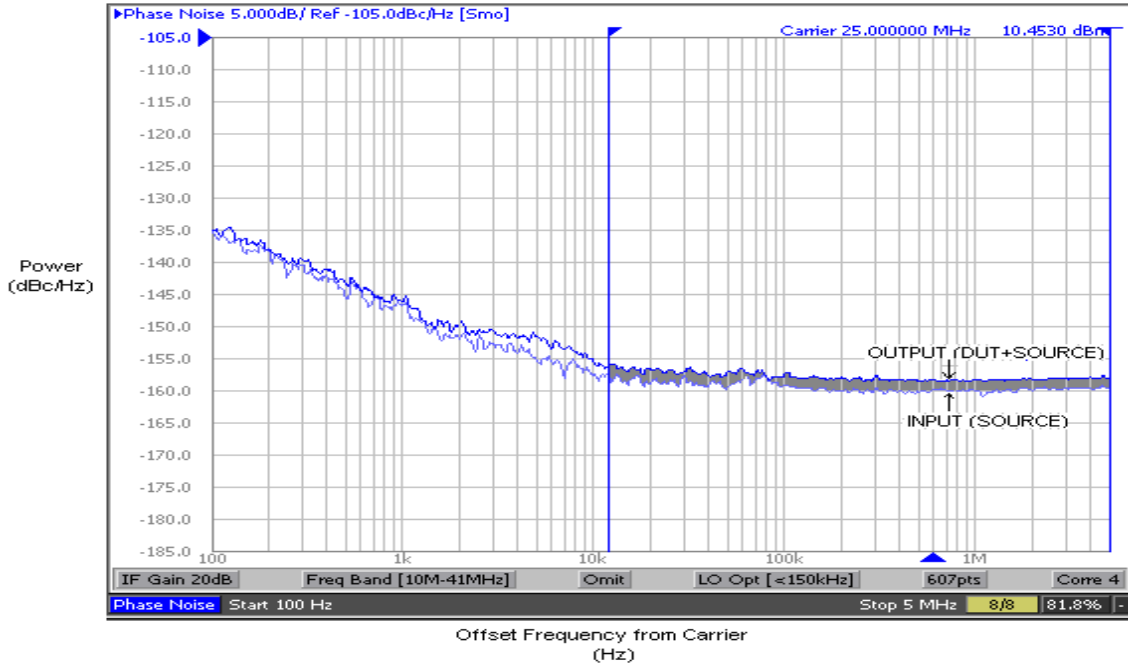

Figure 2. Phase Noise Plot at 25 MHz at an Operating Voltage of 3.3 V, Room Temperature

The above plot captured using Agilent E5052A shows Additive Phase Noise of the NB3N551 device measured with an input source generated by Agilent E8663B. The RMS phase jitter contributed by the device (integrated between 12 kHz to 20 MHz; as shown in the shaded region of the plot) is 43 fs (RMS Jitter of the input source is 203.31 fs and Output (DUT+Source) is 247.06 fs).

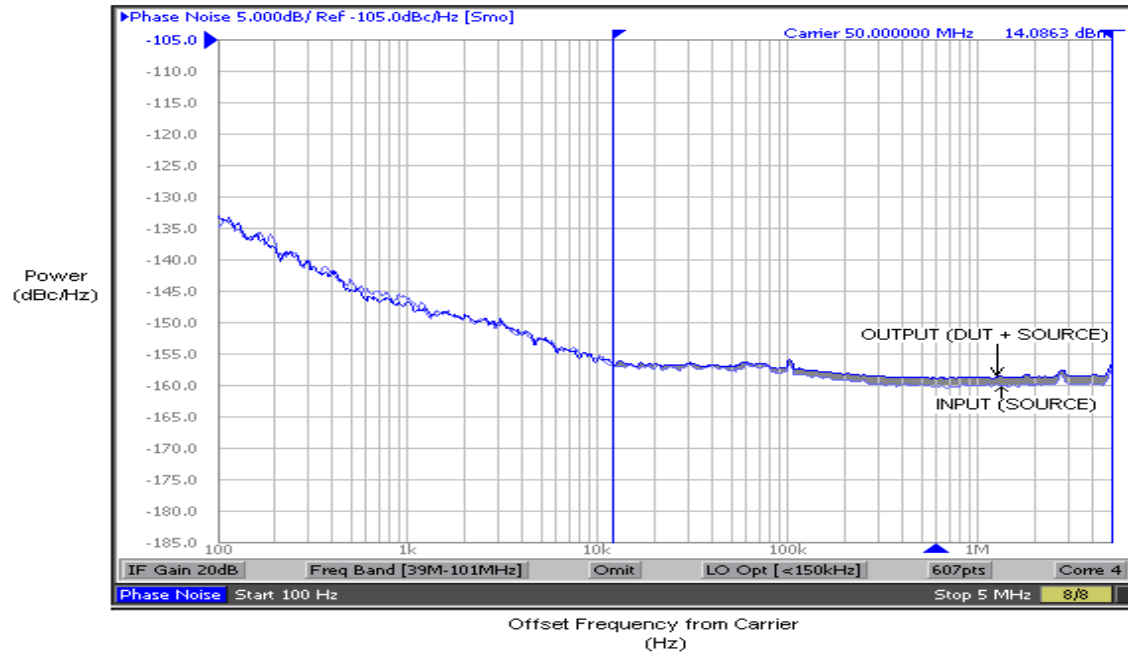
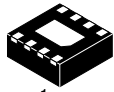

Figure 3. Phase Noise Plot at 50 MHz at an Operating Voltage of 5 V, Room Temperature

The above plot captured using Agilent E5052A shows Additive Phase Noise of the NB3N551 device measured with an input source generated by Agilent E8663B. The RMS phase jitter contributed by the device (integrated between 12 kHz to 20 MHz; as shown in the shaded region of the plot) is 16 fs (RMS Jitter of the input source is 104.08 fs and Output (DUT + Source) is 119.77 fs).

MECHANICAL CASE OUTLINE PACKAGE DIMENSIONS



SCALE 4:1

DFN8 2x2, 0.5P
CASE 506AA
ISSUE F

DATE 04 MAY 2016

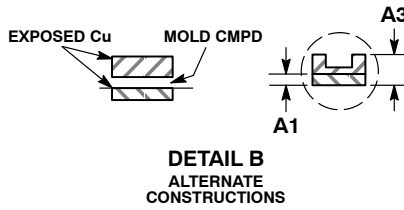
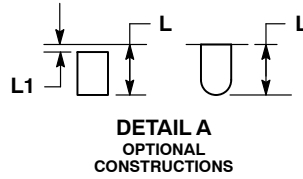
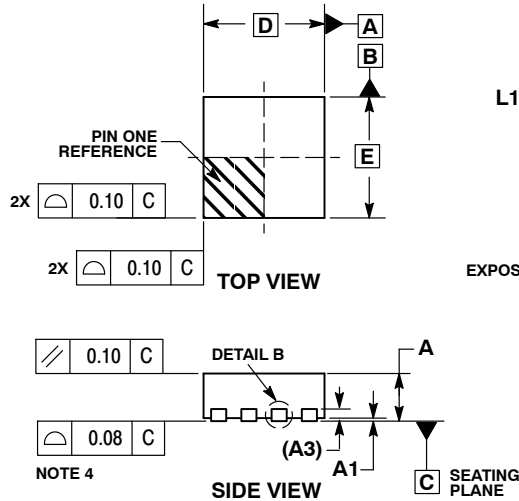

NOTES:

1. DIMENSIONING AND TOLERANCING PER ASME Y14.5M, 1994 .
2. CONTROLLING DIMENSION: MILLIMETERS.
3. DIMENSION b APPLIES TO PLATED TERMINAL AND IS MEASURED BETWEEN 0.15 AND 0.20 MM FROM TERMINAL TIP.
4. COPLANARITY APPLIES TO THE EXPOSED PAD AS WELL AS THE TERMINALS.

MILLIMETERS		
DIM	MIN	MAX
A	0.80	1.00
A1	0.00	0.05
A3	0.20	REF
b	0.20	0.30
D	2.00	BSC
D2	1.10	1.30
E	2.00	BSC
E2	0.70	0.90
e	0.50	BSC
K	0.30	REF
L	0.25	0.35
L1	---	0.10

RECOMMENDED SOLDERING FOOTPRINT*

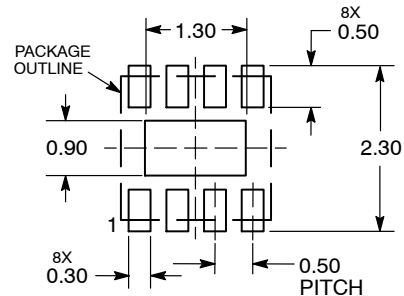

DIMENSIONS: MILLIMETERS

GENERIC MARKING DIAGRAM*

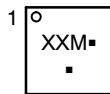

- XX = Specific Device Code
- M = Date Code
- = Pb-Free Device

*This information is generic. Please refer to device data sheet for actual part marking. Pb-Free indicator, "G" or microdot "▪", may or may not be present. Some products may not follow the Generic Marking.

*For additional information on our Pb-Free strategy and soldering details, please download the ON Semiconductor Soldering and Mounting Techniques Reference Manual, SOLDERRM/D.

DOCUMENT NUMBER:	98AON18658D	Electronic versions are uncontrolled except when accessed directly from the Document Repository. Printed versions are uncontrolled except when stamped "CONTROLLED COPY" in red.
DESCRIPTION:	DFN8, 2.0X2.0, 0.5MM PITCH	PAGE 1 OF 1

onsemi and ONSEMI are trademarks of Semiconductor Components Industries, LLC dba onsemi or its subsidiaries in the United States and/or other countries. onsemi reserves the right to make changes without further notice to any products herein. onsemi makes no warranty, representation or guarantee regarding the suitability of its products for any particular purpose, nor does onsemi assume any liability arising out of the application or use of any product or circuit, and specifically disclaims any and all liability, including without limitation special, consequential or incidental damages. onsemi does not convey any license under its patent rights nor the rights of others.

MECHANICAL CASE OUTLINE PACKAGE DIMENSIONS

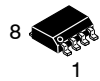

SCALE 1:1

SOIC-8 NB
CASE 751-07
ISSUE AK

DATE 16 FEB 2011

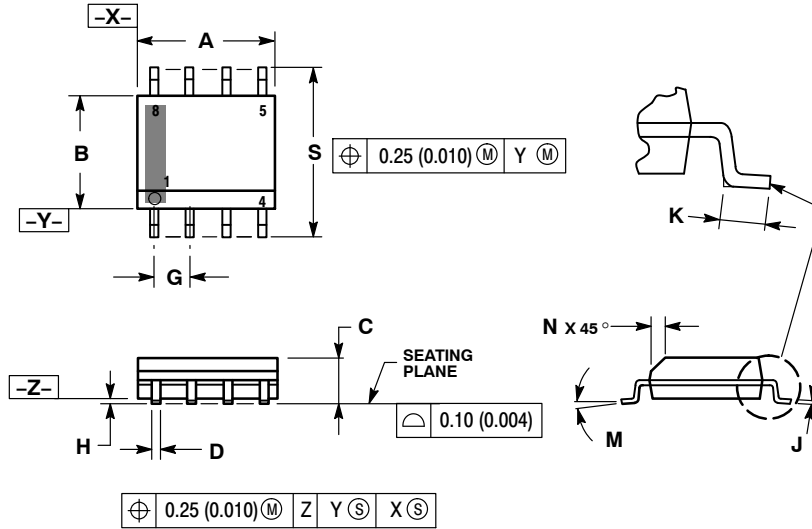

- NOTES:
1. DIMENSIONING AND TOLERANCING PER ANSI Y14.5M, 1982.
 2. CONTROLLING DIMENSION: MILLIMETER.
 3. DIMENSION A AND B DO NOT INCLUDE MOLD PROTRUSION.
 4. MAXIMUM MOLD PROTRUSION 0.15 (0.006) PER SIDE.
 5. DIMENSION D DOES NOT INCLUDE DAMBAR PROTRUSION. ALLOWABLE DAMBAR PROTRUSION SHALL BE 0.127 (0.005) TOTAL IN EXCESS OF THE D DIMENSION AT MAXIMUM MATERIAL CONDITION.
 6. 751-01 THRU 751-06 ARE OBSOLETE. NEW STANDARD IS 751-07.

DIM	MILLIMETERS		INCHES	
	MIN	MAX	MIN	MAX
A	4.80	5.00	0.189	0.197
B	3.80	4.00	0.150	0.157
C	1.35	1.75	0.053	0.069
D	0.33	0.51	0.013	0.020
G	1.27 BSC		0.050 BSC	
H	0.10	0.25	0.004	0.010
J	0.19	0.25	0.007	0.010
K	0.40	1.27	0.016	0.050
M	0°	8°	0°	8°
N	0.25	0.50	0.010	0.020
S	5.80	6.20	0.228	0.244

SOLDERING FOOTPRINT*

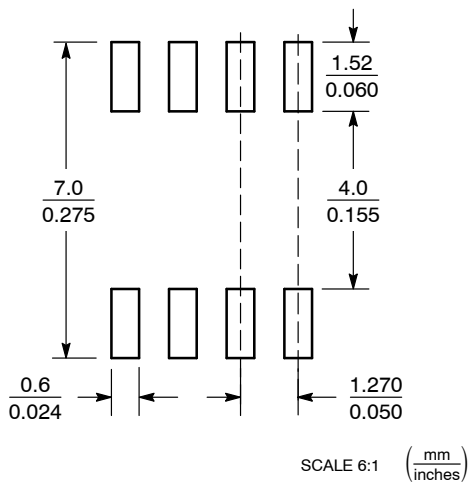

*For additional information on our Pb-Free strategy and soldering details, please download the ON Semiconductor Soldering and Mounting Techniques Reference Manual, SOLDERRM/D.

GENERIC MARKING DIAGRAM*

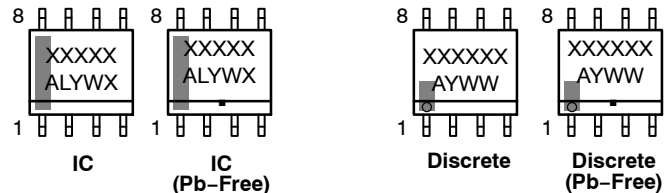

XXXXX = Specific Device Code
 A = Assembly Location
 L = Wafer Lot
 Y = Year
 W = Work Week
 ■ = Pb-Free Package

XXXXXX = Specific Device Code
 A = Assembly Location
 Y = Year
 WW = Work Week
 ■ = Pb-Free Package

*This information is generic. Please refer to device data sheet for actual part marking. Pb-Free indicator, "G" or microdot "•", may or may not be present. Some products may not follow the Generic Marking.

STYLES ON PAGE 2

DOCUMENT NUMBER:	98ASB42564B	Electronic versions are uncontrolled except when accessed directly from the Document Repository. Printed versions are uncontrolled except when stamped "CONTROLLED COPY" in red.
DESCRIPTION:	SOIC-8 NB	PAGE 1 OF 2

onsemi and ONsemi are trademarks of Semiconductor Components Industries, LLC dba onsemi or its subsidiaries in the United States and/or other countries. onsemi reserves the right to make changes without further notice to any products herein. onsemi makes no warranty, representation or guarantee regarding the suitability of its products for any particular purpose, nor does onsemi assume any liability arising out of the application or use of any product or circuit, and specifically disclaims any and all liability, including without limitation special, consequential or incidental damages. onsemi does not convey any license under its patent rights nor the rights of others.

SOIC-8 NB
CASE 751-07
ISSUE AK

DATE 16 FEB 2011

- | | | | |
|--|---|---|---|
| <p>STYLE 1:
 PIN 1. EMITTER
 2. COLLECTOR
 3. COLLECTOR
 4. EMITTER
 5. EMITTER
 6. BASE
 7. BASE
 8. EMITTER</p> | <p>STYLE 2:
 PIN 1. COLLECTOR, DIE, #1
 2. COLLECTOR, #1
 3. COLLECTOR, #2
 4. COLLECTOR, #2
 5. BASE, #2
 6. EMITTER, #2
 7. BASE, #1
 8. EMITTER, #1</p> | <p>STYLE 3:
 PIN 1. DRAIN, DIE #1
 2. DRAIN, #1
 3. DRAIN, #2
 4. DRAIN, #2
 5. GATE, #2
 6. SOURCE, #2
 7. GATE, #1
 8. SOURCE, #1</p> | <p>STYLE 4:
 PIN 1. ANODE
 2. ANODE
 3. ANODE
 4. ANODE
 5. ANODE
 6. ANODE
 7. ANODE
 8. COMMON CATHODE</p> |
| <p>STYLE 5:
 PIN 1. DRAIN
 2. DRAIN
 3. DRAIN
 4. DRAIN
 5. GATE
 6. GATE
 7. SOURCE
 8. SOURCE</p> | <p>STYLE 6:
 PIN 1. SOURCE
 2. DRAIN
 3. DRAIN
 4. SOURCE
 5. SOURCE
 6. GATE
 7. GATE
 8. SOURCE</p> | <p>STYLE 7:
 PIN 1. INPUT
 2. EXTERNAL BYPASS
 3. THIRD STAGE SOURCE
 4. GROUND
 5. DRAIN
 6. GATE 3
 7. SECOND STAGE Vd
 8. FIRST STAGE Vd</p> | <p>STYLE 8:
 PIN 1. COLLECTOR, DIE #1
 2. BASE, #1
 3. BASE, #2
 4. COLLECTOR, #2
 5. COLLECTOR, #2
 6. EMITTER, #2
 7. EMITTER, #1
 8. COLLECTOR, #1</p> |
| <p>STYLE 9:
 PIN 1. EMITTER, COMMON
 2. COLLECTOR, DIE #1
 3. COLLECTOR, DIE #2
 4. EMITTER, COMMON
 5. EMITTER, COMMON
 6. BASE, DIE #2
 7. BASE, DIE #1
 8. EMITTER, COMMON</p> | <p>STYLE 10:
 PIN 1. GROUND
 2. BIAS 1
 3. OUTPUT
 4. GROUND
 5. GROUND
 6. BIAS 2
 7. INPUT
 8. GROUND</p> | <p>STYLE 11:
 PIN 1. SOURCE 1
 2. GATE 1
 3. SOURCE 2
 4. GATE 2
 5. DRAIN 2
 6. DRAIN 2
 7. DRAIN 1
 8. DRAIN 1</p> | <p>STYLE 12:
 PIN 1. SOURCE
 2. SOURCE
 3. SOURCE
 4. GATE
 5. DRAIN
 6. DRAIN
 7. DRAIN
 8. DRAIN</p> |
| <p>STYLE 13:
 PIN 1. N.C.
 2. SOURCE
 3. SOURCE
 4. GATE
 5. DRAIN
 6. DRAIN
 7. DRAIN
 8. DRAIN</p> | <p>STYLE 14:
 PIN 1. N-SOURCE
 2. N-GATE
 3. P-SOURCE
 4. P-GATE
 5. P-DRAIN
 6. P-DRAIN
 7. N-DRAIN
 8. N-DRAIN</p> | <p>STYLE 15:
 PIN 1. ANODE 1
 2. ANODE 1
 3. ANODE 1
 4. ANODE 1
 5. CATHODE, COMMON
 6. CATHODE, COMMON
 7. CATHODE, COMMON
 8. CATHODE, COMMON</p> | <p>STYLE 16:
 PIN 1. EMITTER, DIE #1
 2. BASE, DIE #1
 3. EMITTER, DIE #2
 4. BASE, DIE #2
 5. COLLECTOR, DIE #2
 6. COLLECTOR, DIE #2
 7. COLLECTOR, DIE #1
 8. COLLECTOR, DIE #1</p> |
| <p>STYLE 17:
 PIN 1. VCC
 2. V2OUT
 3. V1OUT
 4. TXE
 5. RXE
 6. VEE
 7. GND
 8. ACC</p> | <p>STYLE 18:
 PIN 1. ANODE
 2. ANODE
 3. SOURCE
 4. GATE
 5. DRAIN
 6. DRAIN
 7. CATHODE
 8. CATHODE</p> | <p>STYLE 19:
 PIN 1. SOURCE 1
 2. GATE 1
 3. SOURCE 2
 4. GATE 2
 5. DRAIN 2
 6. MIRROR 2
 7. DRAIN 1
 8. MIRROR 1</p> | <p>STYLE 20:
 PIN 1. SOURCE (N)
 2. GATE (N)
 3. SOURCE (P)
 4. GATE (P)
 5. DRAIN
 6. DRAIN
 7. DRAIN
 8. DRAIN</p> |
| <p>STYLE 21:
 PIN 1. CATHODE 1
 2. CATHODE 2
 3. CATHODE 3
 4. CATHODE 4
 5. CATHODE 5
 6. COMMON ANODE
 7. COMMON ANODE
 8. CATHODE 6</p> | <p>STYLE 22:
 PIN 1. I/O LINE 1
 2. COMMON CATHODE/VCC
 3. COMMON CATHODE/VCC
 4. I/O LINE 3
 5. COMMON ANODE/GND
 6. I/O LINE 4
 7. I/O LINE 5
 8. COMMON ANODE/GND</p> | <p>STYLE 23:
 PIN 1. LINE 1 IN
 2. COMMON ANODE/GND
 3. COMMON ANODE/GND
 4. LINE 2 IN
 5. LINE 2 OUT
 6. COMMON ANODE/GND
 7. COMMON ANODE/GND
 8. LINE 1 OUT</p> | <p>STYLE 24:
 PIN 1. BASE
 2. EMITTER
 3. COLLECTOR/ANODE
 4. COLLECTOR/ANODE
 5. CATHODE
 6. CATHODE
 7. COLLECTOR/ANODE
 8. COLLECTOR/ANODE</p> |
| <p>STYLE 25:
 PIN 1. VIN
 2. N/C
 3. REXT
 4. GND
 5. IOUT
 6. IOUT
 7. IOUT
 8. IOUT</p> | <p>STYLE 26:
 PIN 1. GND
 2. dv/dt
 3. ENABLE
 4. ILIMIT
 5. SOURCE
 6. SOURCE
 7. SOURCE
 8. VCC</p> | <p>STYLE 27:
 PIN 1. ILIMIT
 2. OVLO
 3. UVLO
 4. INPUT+
 5. SOURCE
 6. SOURCE
 7. SOURCE
 8. DRAIN</p> | <p>STYLE 28:
 PIN 1. SW_TO_GND
 2. DASIC OFF
 3. DASIC_SW_DET
 4. GND
 5. V_MON
 6. VBULK
 7. VBULK
 8. VIN</p> |
| <p>STYLE 29:
 PIN 1. BASE, DIE #1
 2. EMITTER, #1
 3. BASE, #2
 4. EMITTER, #2
 5. COLLECTOR, #2
 6. COLLECTOR, #2
 7. COLLECTOR, #1
 8. COLLECTOR, #1</p> | <p>STYLE 30:
 PIN 1. DRAIN 1
 2. DRAIN 1
 3. GATE 2
 4. SOURCE 2
 5. SOURCE 1/DRAIN 2
 6. SOURCE 1/DRAIN 2
 7. SOURCE 1/DRAIN 2
 8. GATE 1</p> | | |

DOCUMENT NUMBER:	98ASB42564B	Electronic versions are uncontrolled except when accessed directly from the Document Repository. Printed versions are uncontrolled except when stamped "CONTROLLED COPY" in red.
DESCRIPTION:	SOIC-8 NB	PAGE 2 OF 2

onsemi and **ONSEMI** are trademarks of Semiconductor Components Industries, LLC dba **onsemi** or its subsidiaries in the United States and/or other countries. **onsemi** reserves the right to make changes without further notice to any products herein. **onsemi** makes no warranty, representation or guarantee regarding the suitability of its products for any particular purpose, nor does **onsemi** assume any liability arising out of the application or use of any product or circuit, and specifically disclaims any and all liability, including without limitation special, consequential or incidental damages. **onsemi** does not convey any license under its patent rights nor the rights of others.

onsemi, **Onsemi**, and other names, marks, and brands are registered and/or common law trademarks of Semiconductor Components Industries, LLC dba "**onsemi**" or its affiliates and/or subsidiaries in the United States and/or other countries. **onsemi** owns the rights to a number of patents, trademarks, copyrights, trade secrets, and other intellectual property. A listing of **onsemi**'s product/patent coverage may be accessed at www.onsemi.com/site/pdf/Patent-Marking.pdf. **onsemi** reserves the right to make changes at any time to any products or information herein, without notice. The information herein is provided "as-is" and **onsemi** makes no warranty, representation or guarantee regarding the accuracy of the information, product features, availability, functionality, or suitability of its products for any particular purpose, nor does **onsemi** assume any liability arising out of the application or use of any product or circuit, and specifically disclaims any and all liability, including without limitation special, consequential or incidental damages. Buyer is responsible for its products and applications using **onsemi** products, including compliance with all laws, regulations and safety requirements or standards, regardless of any support or applications information provided by **onsemi**. "Typical" parameters which may be provided in **onsemi** data sheets and/or specifications can and do vary in different applications and actual performance may vary over time. All operating parameters, including "Typicals" must be validated for each customer application by customer's technical experts. **onsemi** does not convey any license under any of its intellectual property rights nor the rights of others. **onsemi** products are not designed, intended, or authorized for use as a critical component in life support systems or any FDA Class 3 medical devices or medical devices with a same or similar classification in a foreign jurisdiction or any devices intended for implantation in the human body. Should Buyer purchase or use **onsemi** products for any such unintended or unauthorized application, Buyer shall indemnify and hold **onsemi** and its officers, employees, subsidiaries, affiliates, and distributors harmless against all claims, costs, damages, and expenses, and reasonable attorney fees arising out of, directly or indirectly, any claim of personal injury or death associated with such unintended or unauthorized use, even if such claim alleges that **onsemi** was negligent regarding the design or manufacture of the part. **onsemi** is an Equal Opportunity/Affirmative Action Employer. This literature is subject to all applicable copyright laws and is not for resale in any manner.

ADDITIONAL INFORMATION

TECHNICAL PUBLICATIONS:

Technical Library: www.onsemi.com/design/resources/technical-documentation
onsemi Website: www.onsemi.com

ONLINE SUPPORT: www.onsemi.com/support

For additional information, please contact your local Sales Representative at www.onsemi.com/support/sales