

3.3V / 2.5V / 1.8V / 1.5V 2:1:5 LVCMOS Fanout Buffer

NB3F8L3005C

Description

The NB3F8L3005C is a 2:1:5 Clock / Data fanout buffer operating on a 3.3 V / 2.5 V Core V_{DD} and two flexible 3.3 V / 2.5 V / 1.8 V / 1.5 V V_{DDO_x} supplies which must be equal or less than V_{DD} .

A Mux selects between a Crystal input, or a differential/SE Clock / Data inputs. Differential Inputs accept LVPECL, LVDS, HCSL, or SSTL and Single-Ended levels. The MUX control line, SEL selects CLK/ $\overline{\text{CLK}}$, or Crystal input pins per Table 3. The Crystal input is disabled when a Clock input is selected. Output enable pin, OE, synchronously forces a High Impedance state (Hi-Z) when Low per Table 4.

Outputs consist of five single-ended LVCMOS outputs.

Features

- Five LVCMOS / LVTTTL Outputs up to 200 MHz
- Differential Inputs Accept LVPECL, LVDS, HCSL, SSTL, or LVCMOS/LVTTTL
- Crystal Interface
- Crystal Input Frequency Range: 10 MHz to 50 MHz
- Output Skew: 10 ps Typical
- Additive RMS Phase Jitter @ 156.25 MHz, (12 kHz – 20 MHz): 0.03 ps (Typical)
- Synchronous Output Enable
- Output Defined Level When Input is Floating
- Power Supply Modes:
 - ◆ Single 3.3 V \pm 5%
 - ◆ Single 2.5 V \pm 5%
 - ◆ Mixed 3.3 V \pm 5% Core/2.5 V \pm 5% Output Operating Supply
 - ◆ Mixed 3.3 V \pm 5% Core/1.8 V \pm 0.2 V Output Operating Supply
 - ◆ Mixed 3.3 V \pm 5% Core/1.5 V \pm 0.15 V Output Operating Supply
 - ◆ Mixed 2.5 V \pm 5% Core/ 1.8 V \pm 0.2 V Output Operating Supply
 - ◆ Mixed 2.5 V \pm 5% Core /1.5 V \pm 0.15 V Output Operating Supply
- Two Separate Output Bank Power Supplies
- Industrial Temperature Range: -40°C to 85°C
- These are Pb-Free Devices

Applications

- Clock Distribution
- Networking and Communications
- High End Computing
- Wireless and Wired Infrastructure

End Products

- Servers
- Ethernet Switch/Routers
- ATE
- Test and Measurement



ON Semiconductor®

www.onsemi.com

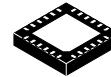

QFN24
G SUFFIX
CASE 485DJ

MARKING DIAGRAM

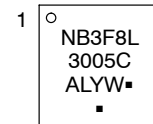

A = Assembly Location
L = Wafer Lot
Y = Year
W = Work Week
▪ = Pb-Free Package

(Note: Microdot may be in either location)

ORDERING INFORMATION

See detailed ordering and shipping information on page 12 of this data sheet.

NB3F8L3005C

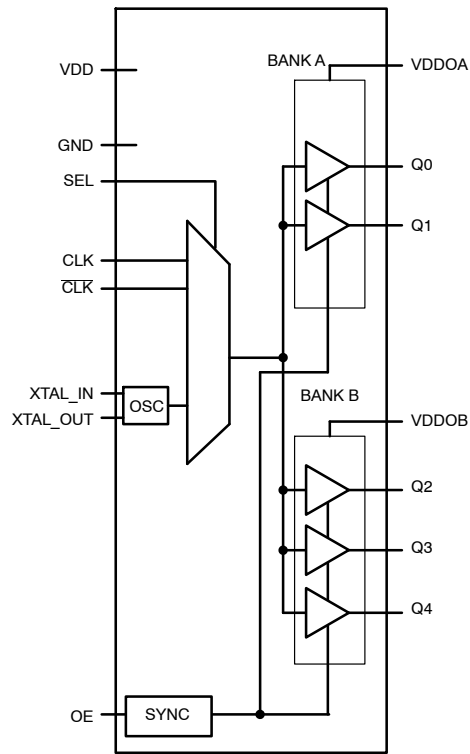

Figure 1. Simplified Logic Diagram

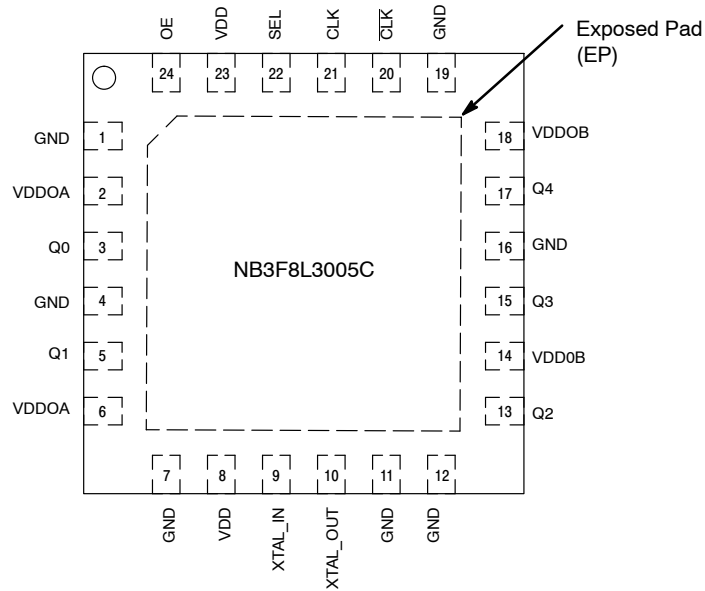

Figure 2. Pinout Configuration (Top View)

NB3F8L3005C

Table 1. PIN DESCRIPTION

Number	Name	Type	Input Default	Description
3, 5	Q0, Q1	LVC MOS		Outputs – Bank A
13, 15, 17	Q2, Q3, Q4	LVC MOS		Outputs – Bank B
2, 6	VDDOA	Power		Positive Supply Pins for Bank A Outputs Q0 – Q1
14, 18	VDDOB	Power		Positive Supply Pins for Bank B Outputs Q2 – Q4
1, 4, 7, 11, 12, 16, 19	GND	GND		Ground Supply
8, 23	VDD	Power		V _{DD} Positive Supply pin for Core and Inputs.
9	XTAL_IN	XTAL OSC / CLK Input		Crystal Oscillator Interface or External Clock Source at LVC MOS Levels
10	XTAL_OUT	XTAL OSC Output		Crystal Interface
20	CLK	Diff / SE Input	Pullup / Pulldown	Inverting differential clock input
21	CLK	Diff / SE Input	Pulldown	Non-inverting clock input
22	SEL	LVC MOS / LV TTL Input	Pulldown	Input clock select. See Table 3 for function. Input Pulldown
24	OE	LVC MOS / LV TTL Input	Pulldown	Output Enable Control. See Table 4 for function.
–	EP	–		The Exposed Pad (EP) on the QFN–24 package bottom is thermally connected to the die for improved heat transfer out of package. The exposed pad must be attached to a heat-sinking conduit. The pad is electrically connected to the die, and must be electrically connected to GND.

- All VDD, VDDO_x and GND pins must be externally connected to a power supply to guarantee proper operation. Bypass each V_{DD} and VDDO_x with 0.01 μF CAP to GND.

Table 2. PIN CHARACTERISTICS

Symbol	Parameter	Min	Typ	Max	Unit
C _{IN}	Input Capacitance		4		pF
R _{PU}	Input Pullup Resistor		50		kΩ
R _{PD}	Input Pulldown Resistor		50		kΩ
C _{PD}	Power Dissipation Capacitance (per output) VDDO = 3.3 V VDDO = 2.5 V VDDO = 1.8 V VDDO = 1.5 V				pF
R _{OUT}	Output Impedance VDDO = 3.3 V VDDO = 2.5 V VDDO = 1.8 V VDDO = 1.5 V		20		Ω

NB3F8L3005C

FUNCTION TABLES

Table 3. CLOCK ENABLE (SELx) FUNCTION TABLE

SEL Input	Selected Input Clock
0	CLK/ $\overline{\text{CLK}}$
1	Crystal Osc Input

Table 4. CLOCK OUTPUT ENABLE (OE) FUNCTION TABLE

OE Input	Q_n Outputs
0	Disabled, High Impedance
1	Outputs Enabled

Table 5. CLK INPUT VS. OUTPUT STATUS

Input Condition	Output
CLK/ $\overline{\text{CLK}}$ = OPEN	Logic LOW
CLK/ $\overline{\text{CLK}}$ = GND	Undefined
CLK = HIGH; $\overline{\text{CLK}}$ = LOW	Logic HIGH
CLK = LOW; $\overline{\text{CLK}}$ = HIGH	Logic LOW

Table 6. CRYSTAL CHARACTERISTICS

Parameter	Min	Typ	Max	Unit
Mode of Oscillation	Fundamental			
Frequency	10		50	MHz
Equivalent Series Resistance (ESR)			50	Ω
Shunt Capacitance			7	pF
Drive Power			100	μW

Table 7. ATTRIBUTES

Characteristic	Value
ESD Protection Human Body Model Machine Model	>2 kV 200 V
Moisture Sensitivity Level (Note 2) QFN24	MSL 1
Flammability Rating Oxygen Index: 28 to 34	UL 94 V-0 @ 0.125 in
Transistor Count	474
Meets or exceeds JEDEC Spec EIA/JESD78 IC Latchup Test	

2. For additional information, see Application Note AND8003/D.

Table 8. MAXIMUM RATINGS (Note 3)

Symbol	Parameter	Condition	Rating	Unit
V_{DD} , V_{DDO_x}	Positive Power Supply	GND = 0 V	4.6	V
V_I	Input Voltage XTAL_IN Diff, SELx, OE Inputs		$0 \leq V_I \leq V_{DD}$ $-0.5 \leq V_I \leq V_{DD} + 0.5$	V
V_O	Output Voltage		$-0.5 \leq V_O \leq V_{DDO_x} + 0.5$	V
T_{stg}	Storage Temperature Range		-65 to +150	$^{\circ}\text{C}$
θ_{JA}	Thermal Resistance (Junction-to-Ambient)	QFN24 QFN24	0 lfpm 500 lfpm	$^{\circ}\text{C}/\text{W}$
θ_{JC}	Thermal Resistance (Junction-to-Case)	QFN24	(Note 3)	$^{\circ}\text{C}/\text{W}$

Stresses exceeding those listed in the Maximum Ratings table may damage the device. If any of these limits are exceeded, device functionality should not be assumed, damage may occur and reliability may be affected.

3. JEDEC standard multilayer board – 2S2P (2 signal, 2 power).

NB3F8L3005C

Table 9. POWER SUPPLY CHARACTERISTICS $V_{DD} \geq V_{DDO}$; $V_{DD} = 3.3 \text{ V} \pm 5\%$ (3.135 V to 3.465 V) or $V_{DD} = 2.5 \text{ V} \pm 5\%$ (2.375 V to 2.625 V) and $V_{DDOx} = 3.3 \text{ V} \pm 5\%$ (3.135 V to 3.465 V) or $2.5 \text{ V} \pm 5\%$ (2.375 V to 2.625 V) or $1.8 \text{ V} \pm 0.2 \text{ V}$ (1.6 V to 2.0 V) or $1.5 \text{ V} \pm 0.15 \text{ V}$ (1.35 V to 1.65 V); $T_A = -40^\circ\text{C}$ to 85°C

Symbol	Parameter	Test Conditions	Min	Typ	Max	Unit
I_{DD}	V_{DD} Power Supply Current	$f_{IN} = 0 \text{ MHz}$ $V_{DDO} = 3.3 \text{ V}, f_{IN} = 100 \text{ MHz}$ $V_{DDO} = 2.5 \text{ V}, f_{IN} = 100 \text{ MHz}$		30 30 20	38	mA
I_{DDO}	V_{DDO} Power Supply Current	OE = 0, no load $V_{DDO} = 3.3 \text{ V}, OE = 1, f_{IN} = 100 \text{ MHz}$ $V_{DDO} = 2.5 \text{ V}, OE = 1, f_{IN} = 100 \text{ MHz}$		0.1 7 5		mA
$I_{DD} + I_{DDO}$	Total Device Current with Loads on All Outputs	OE = 1, $f_{IN} = 100 \text{ MHz}$ OE = 0		48 16		mA

NOTE: Device will meet the specifications after thermal equilibrium has been established when mounted in a test socket or printed circuit board with maintained transverse airflow greater than 500 lpm.

Table 10. DC CHARACTERISTICS $T_A = -40^\circ\text{C}$ to 85°C

Symbol	Parameter	Test Conditions	Min	Typ	Max	Unit
V_{IH}	LVC MOS / LVTTTL Input High Voltage (OE, SEL)	$V_{DD} = 3.3 \text{ V} \pm 5\%$ $V_{DD} = 2.5 \text{ V} \pm 5\%$	1.6 1.3		$V_{DD} + 0.3$ $V_{DD} + 0.3$	V
V_{IL}	LVC MOS / LVTTTL Input Low Voltage (OE, SEL)	$V_{DD} = 3.3 \text{ V} \pm 5\%$ $V_{DD} = 2.5 \text{ V} \pm 5\%$	-0.3 -0.3		0.8 0.4	V
I_{IH}	Input High Current OE, SEL CLK/CLK	$V_{DD} = V_{IN} = 3.465 \text{ V}$ $V_{DD} = V_{IN} = 3.465 \text{ V}$ or 2.625 V			100 100	μA
I_{IL}	Input Low Current OE, SEL CLK CLK	$V_{DD} = 3.465 \text{ V}; V_{IN} = 0.0 \text{ V}$ $V_{DD} = 3.465 \text{ V}$ or $2.625 \text{ V}; V_{IN} = 0.0 \text{ V}$ $V_{DD} = 3.465 \text{ V}$ or $2.625 \text{ V}; V_{IN} = 0.0 \text{ V}$	-5 -5 -150		5	μA
V_{OH}	Output High Voltage		V_{DDO} - 0.1			V
V_{OL}	Output Low Voltage	$V_{DDOx} = 3.3 \text{ V} \pm 5\%$ or $2.5 \text{ V} \pm 5\%$			0.5	V
		$V_{DDOx} = 1.8 \text{ V} \pm 0.2 \text{ V}$			0.4	
		$V_{DDOx} = 1.5 \text{ V} \pm 0.15 \text{ V}$			0.37	
V_{PP}	Peak-to-Peak Input Voltage $V_{IL} > -0.3 \text{ V}$ CLKx/CLKx	$V_{DD} = 3.3 \text{ V} \pm 5\%$ or $V_{DD} = 2.5 \text{ V} \pm 5\%$	0.15		1.3	V
V_{IHCMR}	Input High Level Common Mode Range $V_{CM} = V_{IH}; V_{IL} > -0.3 \text{ V}$ CLKx/CLKx	$V_{DD} = 3.3 \text{ V} \pm 5\%$ or $V_{DD} = 2.5 \text{ V} \pm 5\%$	0.5		$V_{DD} - 0.85$	V

NOTE: Device will meet the specifications after thermal equilibrium has been established when mounted in a test socket or printed circuit board with maintained transverse airflow greater than 500 lpm.

NB3F8L3005C

Table 11. AC CHARACTERISTICS $V_{DD} \geq V_{DDO}$; $V_{DD} = 3.3 \text{ V} \pm 5\%$ (3.135 V to 3.465 V) or $V_{DD} = 2.5 \text{ V} \pm 5\%$ (2.375 V to 2.625 V) and $V_{DDOx} = 3.3 \text{ V} \pm 5\%$ (3.135 V to 3.465 V) or $2.5 \text{ V} \pm 5\%$ (2.375 V to 2.625 V) or $1.8 \text{ V} \pm 0.2 \text{ V}$ (1.6 V to 2.0 V) or $1.5 \text{ V} \pm 0.15 \text{ V}$ (1.35 V to 1.65 V); $T_A = -40^\circ\text{C}$ to 85°C

Symbol	Parameter		Test Conditions	Min	Typ	Max	Unit
f_{MAX}	Output Frequency	Using External Crystal		10		50	MHz
		Using External Clock Source (Note 4)		DC		200	MHz
$t_{sk(o)}$	Output Skew (Notes 5 and 6)				10	25	ps
$t_{JITTER\Phi}$	Additive RMS Phase Jitter (Integrated 12 kHz – 20 MHz) $f_C = 156.25 \text{ MHz}$	Input clock from CLK/CLK	$V_{DDOx} = 3.3 \text{ V} \pm 5\%$		0.03		ps
			$V_{DDOx} = 2.5 \text{ V} \pm 5\%$		0.03		
			$V_{DDOx} = 1.8 \text{ V} \pm 0.2 \text{ V}$		0.03		
			$V_{DDOx} = 1.5 \text{ V} \pm 0.15 \text{ V}$		0.03		
		External clock over drives crystal interface	$V_{DDOx} = 3.3 \text{ V} \pm 5\%$		0.03		
			$V_{DDOx} = 2.5 \text{ V} \pm 5\%$		0.03		
			$V_{DDOx} = 1.8 \text{ V} \pm 0.2 \text{ V}$		0.03		
			$V_{DDOx} = 1.5 \text{ V} \pm 0.15 \text{ V}$		0.03		
		Input clock from crystal	$V_{DDOx} = 3.3 \text{ V} \pm 5\%$		0.03		
			$V_{DDOx} = 2.5 \text{ V} \pm 5\%$		0.03		
			$V_{DDOx} = 1.8 \text{ V} \pm 0.2 \text{ V}$		0.03		
			$V_{DDOx} = 1.5 \text{ V} \pm 0.15 \text{ V}$		0.03		
t_R / t_F	Output Rise/Fall Time (20% and 80%) $C_L = 10 \text{ pF}$	$V_{DDOx} = 3.3 \text{ V} \pm 5\%$	150	350	500	ps	
		$V_{DDOx} = 2.5 \text{ V} \pm 5\%$	150	350	500		
		$V_{DDOx} = 1.8 \text{ V} \pm 0.2 \text{ V}$	150	350	600		
		$V_{DDOx} = 1.5 \text{ V} \pm 0.15 \text{ V}$	150	350	600		
odc	Output Duty Cycle	$V_{DDOx} = 3.3 \text{ V} \pm 5\%$	45		55	%	
		$V_{DDOx} = 2.5 \text{ V} \pm 5\%$	40		60		
		$V_{DDOx} = 1.8 \text{ V} \pm 0.2 \text{ V}$	40		60		
		$V_{DDOx} = 1.5 \text{ V} \pm 0.15 \text{ V}$	40		60		
PSRR	Power Supply Ripple Rejection		100 kHz, 100 mV _{pp} Ripple Injected on V_{DD} , $V_{DDO} = 2.5 \text{ V}$		-44		dBc
t_{EN}	Output Enable Time (Note 7)	OE				4	cycles
t_{DIS}	Output Disable Time (Note 7)	OE				4	cycles
MUX_ISOLATION	MUX_ISOLATION		155.52 MHz	55			dB

NOTE: Device will meet the specifications after thermal equilibrium has been established when mounted in a test socket or printed circuit board with maintained transverse airflow greater than 500 lfm.

4. XTAL_IN can be overdriven relative to a signal a crystal would provide.
5. Defined as skew between outputs at the same supply voltage and with equal load conditions. Measured at $V_{DDOx}/2$.
6. This parameter is defined in accordance with JEDEC Standard 65.
7. These parameters are guaranteed by characterization. Not tested in production. See Parameter Measurement Information
8. AC parameters for LVCMOS are dependent upon output capacitive loading.

PARAMETER MEASUREMENT INFORMATION

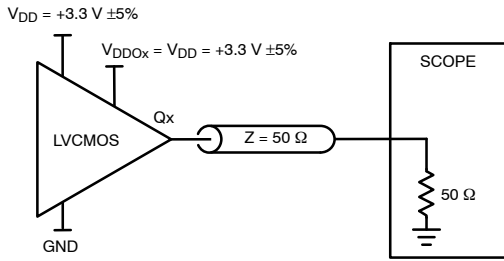

3.3 V Core / 3.3 V Output Load AC Test Circuit

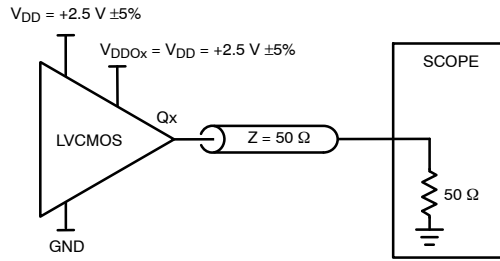

2.5 V Core / 2.5 V Output Load AC Test Circuit

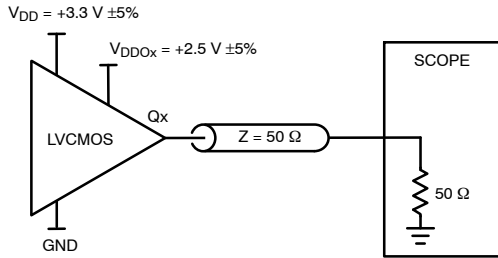

3.3 V Core / 2.5 V Output Load AC Test Circuit

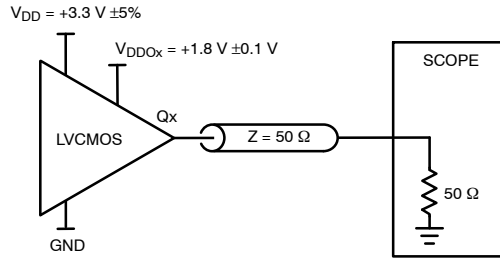

3.3 V Core / 1.8 V Output Load AC Test Circuit

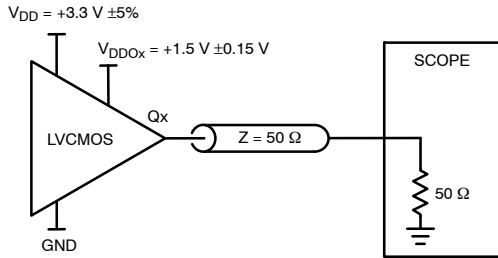

3.3 V Core / 1.5 V Output Load AC Test Circuit

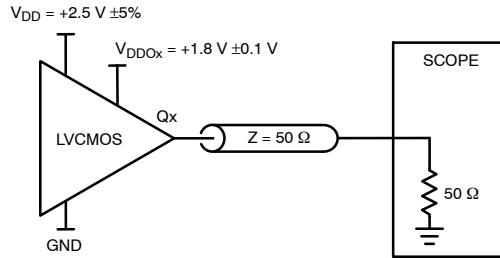

2.5 V Core / 1.8 V Output Load AC Test Circuit

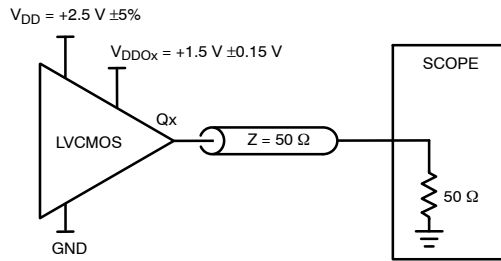

2.5 V Core / 1.5 V Output Load AC Test Circuit

Figure 3. Operational Supply and Termination Test Conditions

PARAMETER MEASUREMENT INFORMATION

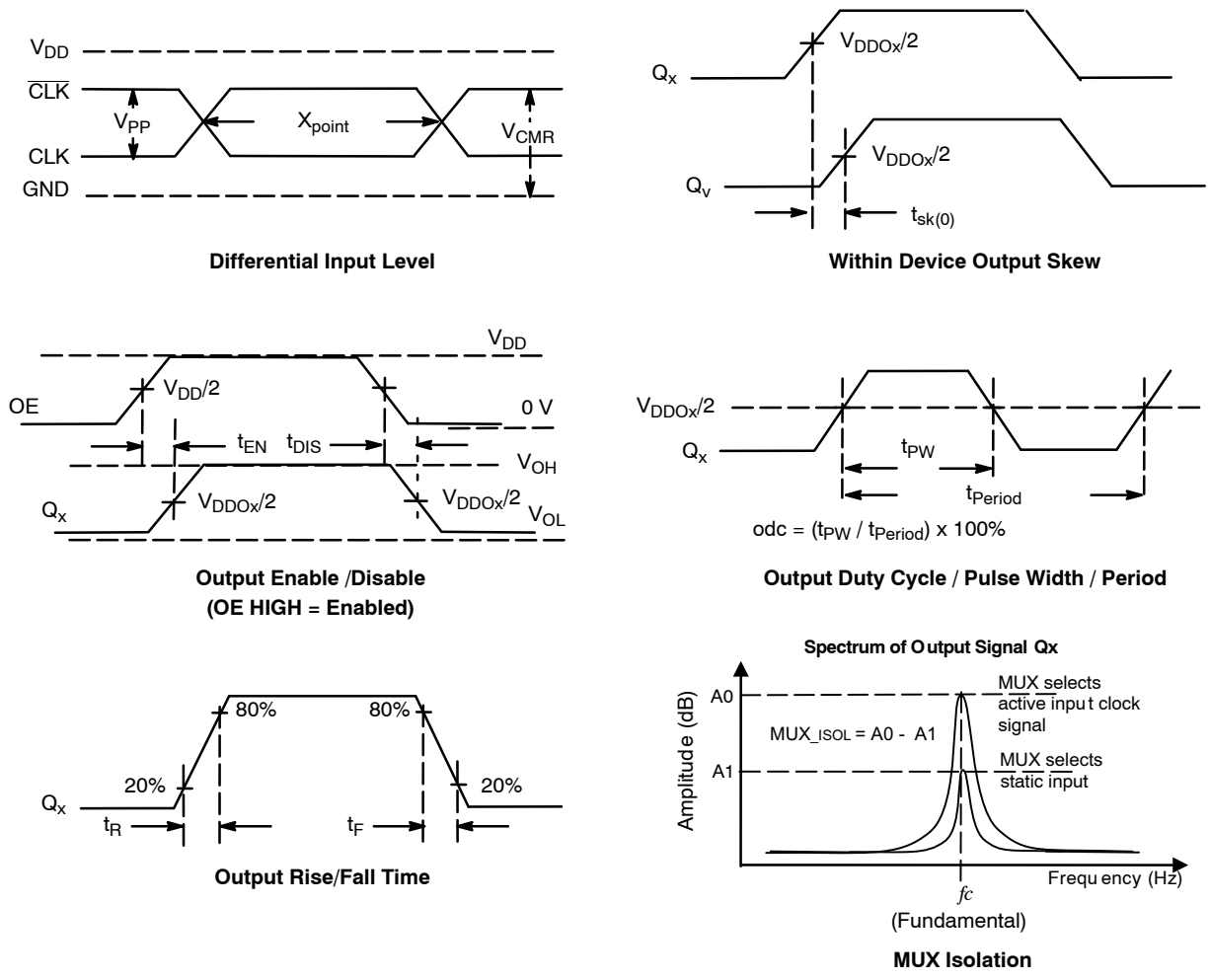

Figure 4. Operational Waveforms and MUX Input Isolation Plot

APPLICATION INFORMATION

Recommendations for Unused LVCMOS Output Pins

Inputs:

CLK/CLK Inputs

For applications not requiring the use of the differential input, both CLK and $\overline{\text{CLK}}$ can be left floating. Though not required, but for additional protection, a 1 kΩ resistor can be tied from CLK to ground.

Crystal Inputs

For applications not requiring the use of the crystal oscillator input, both XTAL_IN and XTAL_OUT can be left floating. Though not required, but for additional protection, a 1 kΩ resistor can be tied from XTAL_IN to ground.

LVCMOS Control Pins

All control pins have internal pulldowns; additional resistance is not required but can be added for additional protection. A 1 kΩ resistor can be used.

Power Supplies

VDD is the power supply for the core and input circuitry.

VDDOA and VDDOB are two separate positive power supplies for two banks of outputs:

VDDOA pins 2 and 6 are connected internally for outputs Q0 – Q1.

VDDOB pins 14 and 18 are connected internally for outputs Q2 – Q4.

Differential Input with Single-Ended Interconnect

Refer to Figure 5 to interconnect a single-ended to a Differential Pair of inputs. The reference bias voltage $V_{REF} = V_{DD}/2$ is generated by the resistor divider of R3 and R4. Bypass capacitor (C1) can filter noise on the DC bias. This bias circuit should be located as close to the input pin as possible. Adjust R1 and R2 to common mode voltage of the signal input swing to preserve duty cycle.

This configuration requires that the sum of the output impedance of the driver (R_o) and the series resistance (R_s) equals the transmission line impedance. In addition, matched termination by R1 and R2 will attenuate the signal

amplitude in half. Termination may be done by using R_s or by using R1 and R2. First, $R_s = 0$ and then R3 and R4 in parallel should equal the transmission line impedance. For most 50 Ω applications, R1 and R2 can be 100 Ω . The differential input can handle full rail LVCMOS signaling, but it is recommended that the amplitude be reduced. The datasheet specifies a differential amplitude which needs to be doubled for a single ended equivalent stimulus. V_{ILmin} cannot be less than -0.3 V and V_{IHmax} cannot be more than $V_{DD} + 0.3$ V. The datasheet specifications are characterized and guaranteed by using a differential signal.

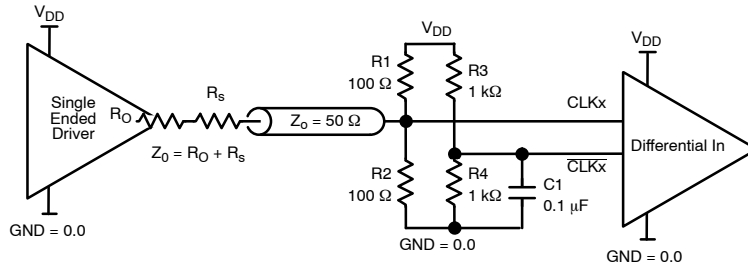

Figure 5. Differential Input with Single-ended Interconnect

Crystal Input Interface

The device has been characterized with 18 pF parallel resonant crystals. The capacitor values, C1 and C2, shown in Figure 6 below as 15 pF were determined using an 18 pF parallel resonant crystal and were chosen to minimize the ppm error. The optimum C1 and C2 values can be slightly adjusted for different board layouts.

CLOCK Overdriving the XTAL Interface

The XTAL_IN input can accept a single-ended LVCMOS signal through an AC coupling capacitor. A general LVCMOS interface diagram is shown in Figure 7 and a general LVPECL interface in Figure 8. The XTAL_OUT pin must be left floating. The maximum amplitude of the input signal should not exceed 2 V and the input edge rate can be as slow as 10 ns. This configuration requires that the output impedance of the driver (R_o) plus the series resistance (R_s) equals the transmission line impedance. In addition, matched termination at the crystal input will attenuate the signal in half. This can be done in one of two ways. First, R1 and R2 in parallel should equal the transmission line impedance. For most 50 Ω applications, R1 and R2 can be 100 Ω . This can also be accomplished by removing R1 and making R2 50 Ω . By overdriving the crystal oscillator, the device will be functional, but note, the device performance is guaranteed by using a quartz crystal.

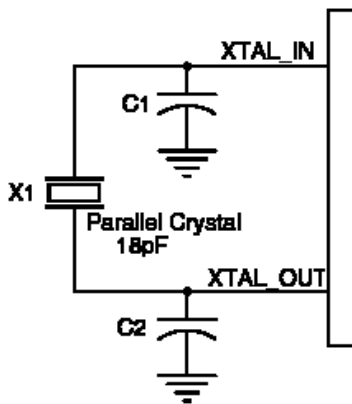

Figure 6. Crystal Input Interface

NB3F8L3005C

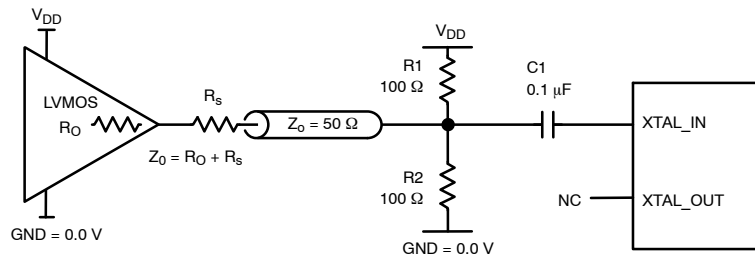

Figure 7. General Diagram for LVMOS Driver to XTAL Input Interface Use R_s or R_1 / R_2

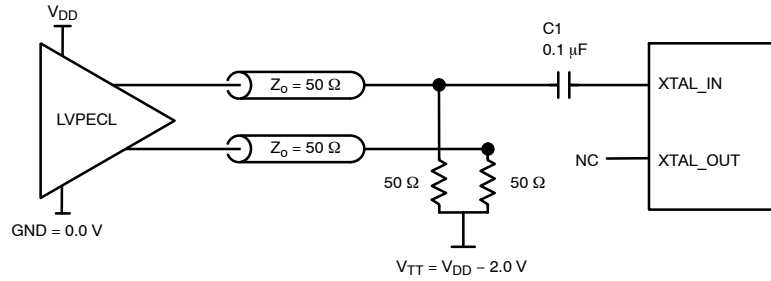

Figure 8. General Diagram for LVPECL Driver to XTAL Input Interface

Differential Clock Input Interface

The CLK / $\overline{\text{CLK}}$ accept LVDS, LVPECL, SSTL, HCSL differential signals. Signals must meet the V_{PP} and V_{CMR} input requirements. Figures 9 to 13 show interface examples for the CLK / $\overline{\text{CLK}}$ input with built-in 50 Ω terminations driven by the most common driver types. The

input interfaces suggested here are examples only. If the driver is from another vendor, use their termination recommendation. Please consult with the vendor of the driver component to confirm the driver termination requirements.

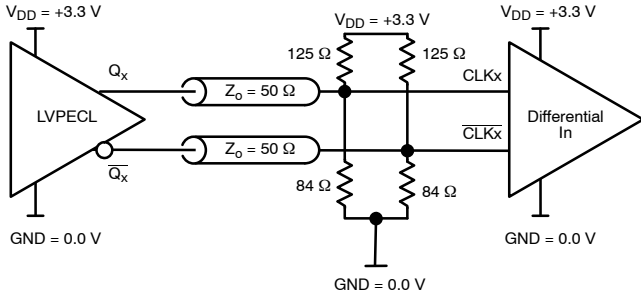

Figure 9. CLK / $\overline{\text{CLK}}$ Input Driven by 3.3 V LVPECL Driver (Thevenin Parallel Termination)

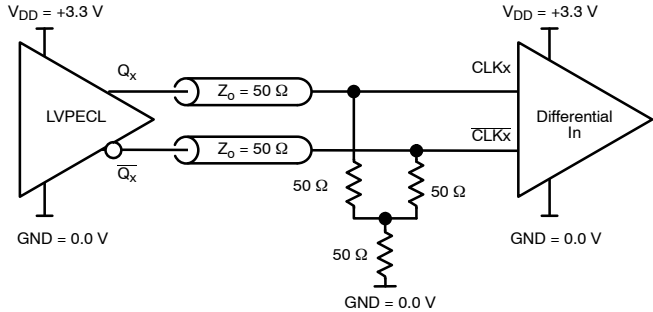

Figure 10. CLK / $\overline{\text{CLK}}$ Input Driven by 3.3 V LVPECL Driver ("Y" Parallel Termination)

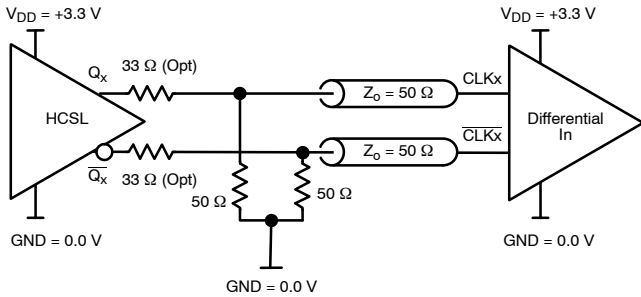

Figure 11. CLK / $\overline{\text{CLK}}$ Input Driven by a 3.3 V HCSL Driver

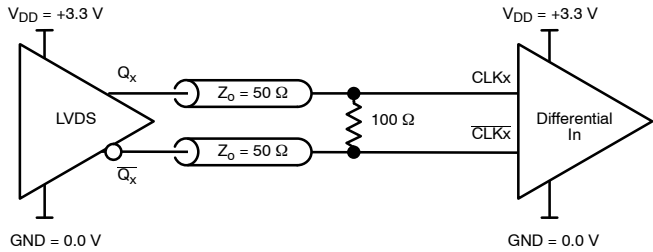

Figure 12. CLK / $\overline{\text{CLK}}$ Input Driven by 3.3 V LVDS Driver

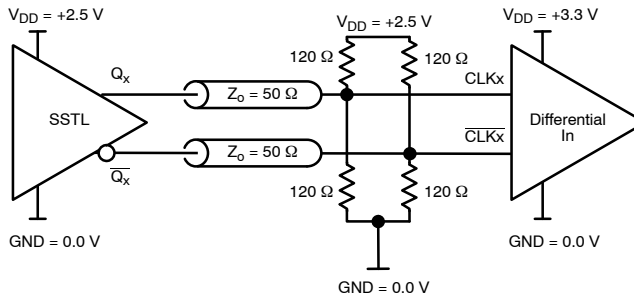

Figure 13. CLK / $\overline{\text{CLK}}$ Input Driven by 2.5 V SSTL Driver

NB3F8L3005C

VFQFN EPAD Thermal Release Path

In order to maximize both the removal of heat from the package and the electrical performance, a land pattern must be incorporated on the Printed Circuit Board (PCB) within the footprint of the package corresponding to the exposed metal pad or exposed heat slug on the package, as shown in Figure 14. The solderable area on the PCB, as defined by the solder mask, should be at least the same size/shape as the exposed pad/slug area on the package to maximize the thermal/electrical performance. Sufficient clearance should be designed on the PCB between the outer edges of the land pattern and the inner edges of pad pattern for the leads to avoid any shorts. While the land pattern on the PCB provides a means of heat transfer and electrical grounding from the package to the board through a solder joint, thermal vias are necessary to effectively conduct from the surface of the PCB to the ground plane(s). The land pattern must be connected

to ground through these vias. The vias act as “heat pipes”. The number of vias (i.e. “heat pipes”) is application specific and dependent upon the package power dissipation as well as electrical conductivity requirements. Thus, thermal and electrical analysis and/or testing are recommended to determine the minimum number needed. Maximum thermal and electrical performance is achieved when an array of vias is incorporated in the land pattern. It is recommended to use as many vias connected to ground as possible. It is also recommended that the via diameter should be 12 to 13 mils (0.30 to 0.33 mm) with 1 oz copper via barrel plating. This is desirable to avoid any solder wicking inside the via during the soldering process which may result in voids in solder between the exposed pad/slug and the thermal land. Precautions should be taken to eliminate any solder voids between the exposed heat slug and the land pattern. Note: These recommendations are to be used as a guideline only.

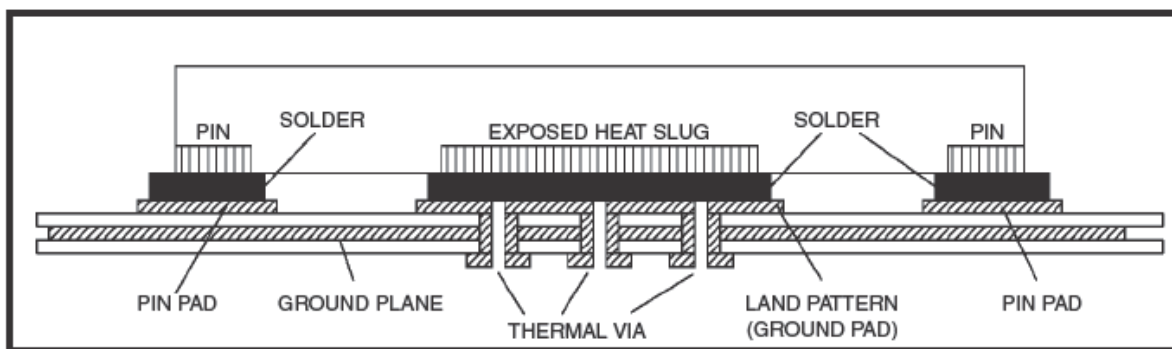

Figure 14. Suggested Assembly for Exposed Pad Thermal Release Path – Cut-away View (not to scale)

ORDERING INFORMATION

Device	Package	Shipping†
NB3F8L3005CMNTXG	QFN24 (Pb-Free)	3000 / Tape & Reel
NB3F8L3005CMNTBG	QFN24 (Pb-Free)	1000 / Tape & Reel

†For information on tape and reel specifications, including part orientation and tape sizes, please refer to our Tape and Reel Packaging Specifications Brochure, BRD8011/D.

MECHANICAL CASE OUTLINE

PACKAGE DIMENSIONS

ON Semiconductor®

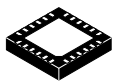

SCALE 2:1

QFN24, 4x4, 0.5P
CASE 485DJ
ISSUE O

DATE 28 OCT 2013

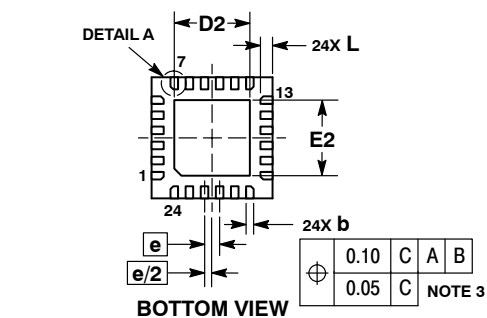
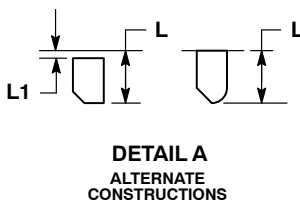
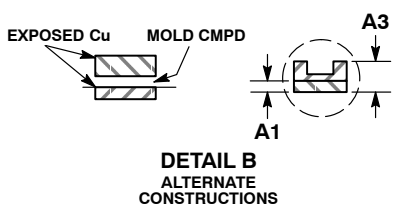
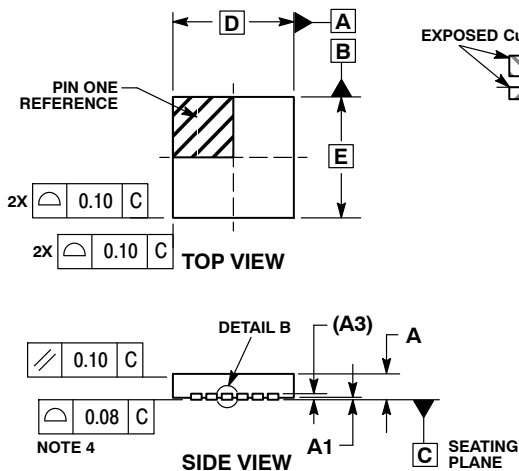

- NOTES:
1. DIMENSIONING AND TOLERANCING PER ASME Y14.5M, 1994.
 2. CONTROLLING DIMENSION: MILLIMETERS.
 3. DIMENSION b APPLIES TO PLATED TERMINAL AND IS MEASURED BETWEEN 0.25 AND 0.30 MM FROM THE TERMINAL TIP.
 4. COPLANARITY APPLIES TO THE EXPOSED PAD AS WELL AS THE TERMINALS.

MILLIMETERS		
DIM	MIN	MAX
A	0.80	0.90
A1	0.00	0.05
A3	0.20	REF
b	0.20	0.30
D	4.00	BSC
E2	2.40	2.60
E	4.00	BSC
E2	2.40	2.60
e	0.50	BSC
L	0.30	0.50
L1	---	0.15

GENERIC MARKING DIAGRAM*

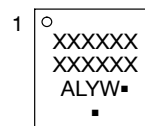

- XXXXXX= Specific Device Code
 A = Assembly Location
 L = Wafer Lot
 Y = Year
 W = Work Week
 ■ = Pb-Free Package

(Note: Microdot may be in either location)

*This information is generic. Please refer to device data sheet for actual part marking. Pb-Free indicator, "G" or microdot "■", may or may not be present.

RECOMMENDED SOLDERING FOOTPRINT*

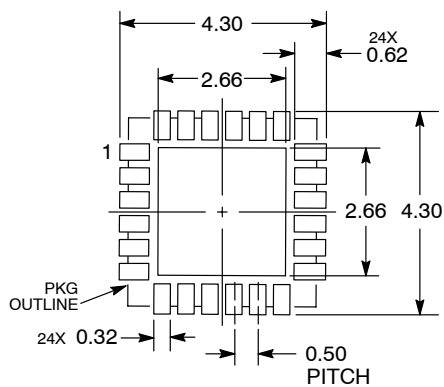

DIMENSIONS: MILLIMETERS

*For additional information on our Pb-Free strategy and soldering details, please download the ON Semiconductor Soldering and Mounting Techniques Reference Manual, SOLDERRM/D.

DOCUMENT NUMBER:	98AON79518F	Electronic versions are uncontrolled except when accessed directly from the Document Repository. Printed versions are uncontrolled except when stamped "CONTROLLED COPY" in red.
DESCRIPTION:	QFN24, 4X4, 0.5P	PAGE 1 OF 1

ON Semiconductor and ON are trademarks of Semiconductor Components Industries, LLC dba ON Semiconductor or its subsidiaries in the United States and/or other countries. ON Semiconductor reserves the right to make changes without further notice to any products herein. ON Semiconductor makes no warranty, representation or guarantee regarding the suitability of its products for any particular purpose, nor does ON Semiconductor assume any liability arising out of the application or use of any product or circuit, and specifically disclaims any and all liability, including without limitation special, consequential or incidental damages. ON Semiconductor does not convey any license under its patent rights nor the rights of others.

onsemi, **Onsemi**, and other names, marks, and brands are registered and/or common law trademarks of Semiconductor Components Industries, LLC dba "**onsemi**" or its affiliates and/or subsidiaries in the United States and/or other countries. **onsemi** owns the rights to a number of patents, trademarks, copyrights, trade secrets, and other intellectual property. A listing of **onsemi**'s product/patent coverage may be accessed at www.onsemi.com/site/pdf/Patent-Marking.pdf. **onsemi** reserves the right to make changes at any time to any products or information herein, without notice. The information herein is provided "as-is" and **onsemi** makes no warranty, representation or guarantee regarding the accuracy of the information, product features, availability, functionality, or suitability of its products for any particular purpose, nor does **onsemi** assume any liability arising out of the application or use of any product or circuit, and specifically disclaims any and all liability, including without limitation special, consequential or incidental damages. Buyer is responsible for its products and applications using **onsemi** products, including compliance with all laws, regulations and safety requirements or standards, regardless of any support or applications information provided by **onsemi**. "Typical" parameters which may be provided in **onsemi** data sheets and/or specifications can and do vary in different applications and actual performance may vary over time. All operating parameters, including "Typicals" must be validated for each customer application by customer's technical experts. **onsemi** does not convey any license under any of its intellectual property rights nor the rights of others. **onsemi** products are not designed, intended, or authorized for use as a critical component in life support systems or any FDA Class 3 medical devices or medical devices with a same or similar classification in a foreign jurisdiction or any devices intended for implantation in the human body. Should Buyer purchase or use **onsemi** products for any such unintended or unauthorized application, Buyer shall indemnify and hold **onsemi** and its officers, employees, subsidiaries, affiliates, and distributors harmless against all claims, costs, damages, and expenses, and reasonable attorney fees arising out of, directly or indirectly, any claim of personal injury or death associated with such unintended or unauthorized use, even if such claim alleges that **onsemi** was negligent regarding the design or manufacture of the part. **onsemi** is an Equal Opportunity/Affirmative Action Employer. This literature is subject to all applicable copyright laws and is not for resale in any manner.

ADDITIONAL INFORMATION

TECHNICAL PUBLICATIONS:

Technical Library: www.onsemi.com/design/resources/technical-documentation
onsemi Website: www.onsemi.com

ONLINE SUPPORT: www.onsemi.com/support

For additional information, please contact your local Sales Representative at www.onsemi.com/support/sales