

N24RF04E

RFID 4 Kb EEPROM Tag ISO 15693 RF, I²C Bus, Energy Harvesting

Description

The N24RF04E is a RFID/NFC tag with a 4 Kb EEPROM device, offering both contactless and contact interface. In addition to the ISO/IEC 15693 radio frequency identification (RFID) interface protocol, the device features an I²C interface to communicate with a microcontroller. The I²C contact interface requires an external power supply.

The 4 Kb EEPROM array is internally organized as 128 x 32 bits in RF mode and as 512 x 8 bits when accessed from the I²C interface.

Features

- Contactless Transmission of Data
- ISO 15693 / ISO 18000–3 Mode1 Compliant
 - ◆ Vicinity Range Communication (up to 150 cm)
 - ◆ Air Interface Communication at 13.56 MHz (HF)
 - ◆ To Tag: ASK Modulation with 1.65 Kbit/s or 26.48 Kbit/s Data Rate
 - ◆ From Tag: Load Modulation Using Manchester Coding with 423 kHz and 484 kHz Subcarriers in Low (6.6 Kbit/s) or High (26 Kbit/s) Data Rate Mode. Supports the 53 Kbit/s Data Rate with Fast Commands
- Read & Write 32-bit Block Mode
- Anti-collision Support
- Security:
 - ◆ 64-bit Unique Identifier (UID)
 - ◆ Multiple 32-bit Passwords and Lock Feature for Each User Memory Sector
- Supports Fast (400 kHz) and Fast-Plus (1 MHz) I²C Protocol
- 1.8 V to 5.5 V Supply Voltage Range
- 4-Byte Page Write Buffer
- I²C Timeout
- Schmitt Triggers and Noise Suppression Filters on I²C Bus Inputs (SCL and SDA)
- 128 Blocks x 32 Bits (4 Sectors of 32 Blocks Each): RF Mode
- 512 x 8 Bits I²C Mode
- 2,000,000 Program/Erase Cycles
- 200 Year Data Retention
- -40°C to +105°C Temperature Range
- Configurable Output Pin: RF Write in Progress or RF Busy
- Energy Harvesting Analog Output
- SOIC, TSSOP 8-lead Packages
- These Devices are Pb-Free, Halogen Free/BFR Free and are RoHS Compliant*



ON Semiconductor®

www.onsemi.com



SOIC 8
CASE 751BD



TSSOP8, 4.4x3
CASE 948AL

PIN CONFIGURATION

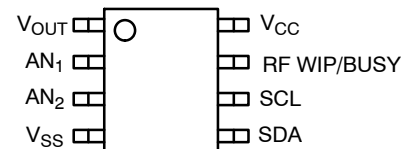

SOIC (W, X), TSSOP (Y)

PIN FUNCTION

Pin Name	Function
SDA	Serial Data
SCL	Serial Clock
AN1, AN2	Antenna Coil
V _{CC}	Power Supply
V _{SS}	Ground
V _{OUT}	Energy Harvesting Output
RF WIP/BUSY	Internal Write or RF command in progress

MARKING DIAGRAMS

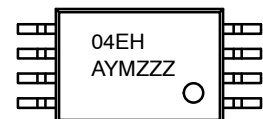
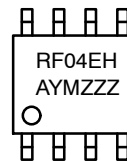

A = Assembly Site Code
 Y = Production Year (Last Digit)
 M = Production Month Code
 ZZZ = Last 3 Characters of Assembly Lot Number

ORDERING INFORMATION

See detailed ordering and shipping information on page 22 of this data sheet.

*For additional information on our Pb-Free strategy and soldering details, please download the ON Semiconductor Soldering and Mounting Techniques Reference Manual, SOLDERRM/D.

N24RF04E

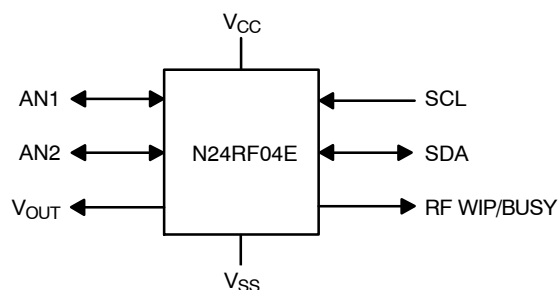

Figure 1. Functional Symbol

Table 1. ABSOLUTE MAXIMUM RATINGS

Parameter	Rating	Unit
Storage Temperature	-65 to +150	°C
Ambient Operating Temperature	-40 to +105	°C
Voltage on SCL, SDA, RF WIP/BUSY and V _{CC} pins with respect to Ground (Note 1)	-0.5 to 6.5	V
RF Input Voltage Peak to Peak Amplitude between AN1 and AN2, V _{SS} pad floating	28	V
AC Voltage on AN1 or AN2 with respect to GND	-1 to 15	V

Stresses exceeding those listed in the Maximum Ratings table may damage the device. If any of these limits are exceeded, device functionality should not be assumed, damage may occur and reliability may be affected.

1. During transitions, the voltage undershoot on any pin should not exceed 1 V for more than 20 ns. Voltage overshoot on the SCL and SDA I²C pins should not exceed the absolute maximum ratings, irrespective of V_{CC}.

Table 2. RELIABILITY CHARACTERISTICS – EEPROM (Note 2)

Symbol	Parameter	Test Conditions	Max	Unit
NEND	Endurance	T _A ≤ 25°C, 1.8 V < V _{CC} < 5.5 V	2,000,000	Write Cycles (Note 3)
		T _A = 85°C, 1.8 V < V _{CC} < 5.5 V	800,000	
		T _A = 105°C, 1.8 V < V _{CC} < 5.5 V	300,000	
TDR	Data Retention	T _A = 25°C	200	Year

2. Determined through qualification/characterization.

3. A Write Cycle refers to writing a Byte or a Page.

N24RF04E

Table 3. DC CHARACTERISTICS – I²C MODE ($V_{CC} = 1.8\text{ V to }5.5\text{ V}$, $T_A = -40^\circ\text{C to }+105^\circ\text{C}$, unless otherwise specified)

Symbol	Parameter	Test Conditions		Min	Max	Unit
ICCR	Supply Current (Read Mode)	Read, $f_{SCL} = 400\text{ kHz}$	$V_{CC} = 1.8\text{ V}$	–	0.15	mA
			$V_{CC} = 2.5\text{ V}$	–	0.2	
			$V_{CC} = 5.5\text{ V}$	–	0.3	
ICCW	Supply Current (Write Mode)	Write Cycle		–	0.4	mA
ISB1	Standby Current	$V_{IN} = \text{GND or } V_{CC}$	No RF Field on antenna coil	–	10	μA
			Both V_{CC} Supply and RF Field on antenna coil	–	100	μA
IL	Input Leakage Current	$V_{IN} = \text{GND or } V_{CC}$		–2	2	μA
ILO	Output Leakage Current	SDA = Hi Z, $V_{OUT} = \text{GND or } V_{CC}$		–2	2	μA
VIL1	Input Low Voltage	$V_{CC} \geq 2.5\text{ V}$		–0.5	$0.3 V_{CC}$	V
VIH1	Input High Voltage	$V_{CC} \geq 2.5\text{ V}$		$0.7 V_{CC}$	$V_{CC}+0.5$	V
VIL2	Input Low Voltage	$V_{CC} < 2.5\text{ V}$		–0.5	$0.25 V_{CC}$	V
VIH2	Input High Voltage	$V_{CC} < 2.5\text{ V}$		$0.75 V_{CC}$	$V_{CC}+0.5$	V
VOL1	Output Low Voltage	$V_{CC} \geq 2.5\text{ V}$, $I_{OL} = 3.0\text{ mA}$		–	0.4	V
VOL2	Output Low Voltage	$V_{CC} < 2.5\text{ V}$, $I_{OL} = 2.1\text{ mA}$		–	0.2	V

Product parametric performance is indicated in the Electrical Characteristics for the listed test conditions, unless otherwise noted. Product performance may not be indicated by the Electrical Characteristics if operated under different conditions.

Table 4. PIN IMPEDANCE CHARACTERISTICS

Symbol	Parameter	Conditions	Max	Unit
C_{IN} (Note 4)	I/O Pin Capacitance (SDA, RF WIP/BUSY)	$V_{IN} = 0\text{ V}$	8	pF
C_{IN} (Note 4)	Input Capacitance (other pins)	$V_{IN} = 0\text{ V}$	6	pF

4. These parameters are tested initially and after a design or process change that affects the parameter according to appropriate AEC-Q100 and JEDEC test methods.

N24RF04E

Table 5. AC CHARACTERISTICS – I²C MODE (Note 5) ($V_{CC} = 1.8\text{ V to }5.5\text{ V}$, $T_A = -40^\circ\text{C to }+105^\circ\text{C}$, unless otherwise specified)

Symbol	Parameter	I ² C Fast		I ² C Fast Plus		Unit
		Min	Max	Min	Max	
F _{SCL}	Clock Frequency	25	400	25	1000	kHz
t _{LOW}	Low Period of SCL Clock	1.3	20000	0.45	20000	μs
t _{HIGH}	High Period of SCL Clock	0.6	20000	0.40	20000	μs
t _{SU:STA}	START Condition Setup Time	0.6	–	0.25		μs
t _{HD:STA}	START Condition Hold Time	0.6	20000	0.25	20000	μs
t _{HD:DAT}	Data In Hold Time	0	–	0	–	μs
t _{SU:DAT}	Data In Setup Time	100	–	50	–	ns
t _R (Note 6)	SDA and SCL Rise Time	–	300	–	100	ns
t _F (Note 6)	SDA and SCL Fall Time	–	300	–	100	ns
t _{SU:STO}	STOP Condition Setup Time	0.6	–	0.25	–	μs
t _{BUF}	Bus Free Time Between STOP and START	1.3	–	0.5	–	μs
t _{AA}	SCL Low to Data Out Valid	–	0.9	–	0.4	μs
t _{DH}	Data Out Hold Time	100	–	50	–	ns
T _i (Note 6)	Noise Pulse Filtered at SCL and SDA Inputs	–	50	–	50	ns
t _{WR}	Write Cycle Time	–	5	–	5	ms
t _{PU} (Notes 6, 7)	Power-up to Ready Mode	–	1	–	1	ms

5. Test conditions according to “AC Test Conditions” table.

6. Tested initially and after a design or process change that affects this parameter.

7. t_{PU} is the delay between the time V_{CC} is stable and the device is ready to accept commands.

Table 6. AC TEST CONDITIONS

Parameter	Condition
Input Levels	0.2 x V _{CC} to 0.8 x V _{CC}
Input Rise and Fall Times	≤ 50 ns
Output Reference Levels	0.5 x V _{CC}
Output Load	Current Source: I _{OL} = 3 mA (V _{CC} ≥ 2.5 V); I _{OL} = 2 mA (V _{CC} < 2.5 V); C _L = 100 pF

N24RF04E

Table 7. RF CHARACTERISTICS ($T_A = -40^{\circ}\text{C}$ to $+105^{\circ}\text{C}$, unless otherwise specified)

Symbol	Parameter	Test Conditions	Min	Typ	Max	Unit
f_{CC}	External RF signal frequency		13.553	13.56	13.567	MHz
H_{ISO}	Operating field		150	–	5000	mA/m
MI_Carrier (10%)	10% Carrier Modulation Index $MI = (a - b) / (a + b)$	150 mA/m < H_{ISO} < 1000 mA/m	10	–	30	%
		H_{ISO} > 1000 mA/m	15	–	30	%
$t_{1:10\%}$	10% Fall and Low Time	$t_1 = t_2$	6.0	–	9.44	μs
$t_{2:10\%}$	10% Minimum Low Time	$t_1 = 9.44 \mu\text{s}$	4.5	–	t_1	μs
$t_{3:10\%}$	10% Rise Time	$t_1 = 9.44 \mu\text{s}$	0	–	4.5	μs
MI_Carrier (100%)	100% Carrier Modulation Index	$MI = (a - b) / (a + b)$	95	–	100	%
$t_{1:100\%}$	100% Fall and Low Time	$t_1 = t_2$	6.0	–	9.44	μs
$t_{2:100\%}$	100% Minimum Pulse Width Low Time	$t_1 = 9.44 \mu\text{s}$	2.1	–	t_1	μs
$t_{3:100\%}$	100% Rise Time	$t_1 = 9.44 \mu\text{s}$	0	–	3	μs
$t_{4:100\%}$	100% Rise Time to 60% of Amplitude		0	–	0.8	μs
$t_{MIN\ C-D}$	Minimum delay from Carrier generation to first Data	150 mA/m < H_{ISO} < 1000 mA/m	–	–	1	ms
		$H_{ISO} > 1000 \text{ mA/m}$	–	–	2	ms
f_{SH}	Subcarrier Frequency High	$f_{CC}/32$	–	423.75	–	kHz
f_{SL}	Subcarrier Frequency Low	$f_{CC}/28$	–	484.28	–	kHz
t_{RESP}	N24RF04E Tag Response Time	4352/FS	318.4	320.9	323.5	μs
t_{WRF}	RF Write Time (with internal Verify)	78080/FS	5.753	5.758	5.763	ms
C_{TUN}	Internal Tuning Capacitor (TSSOP-8) (Note 10)	$f = 13.56 \text{ MHz};$ $V_{an1} - V_{an2} = 1 \text{ V}_{p-p}$	–	26	–	pF
V_{MAX-1}	RF Input Voltage between AN1 and AN2 (peak to peak), V_{SS} pad floating (Note 10)		–	–	22	V
V_{MAX-2}	AC voltage on AN1 or AN2 with respect to GND (Note 10)		–1	–	11	V
V_{MIN-1}	RF Input Voltage between AN1 and AN2 (peak to peak), V_{SS} pad floating (Note 10)		–	4	–	V
V_{MIN-2}	AC voltage on AN1 or AN2 with respect to GND (Note 10)		–	2.1	–	V
V_{BACK}	Backscattered Level (ISO Test)	ISO10373-7	10	–	–	mV
T_{RF-OFF}	RF Off Time	Chip reset	2	–	–	ms

8. Characterized only.

9. All measurements performed on an antenna with the following characteristics:

- External size: 72 mm x 42 mm
- Number of turns: 7
- Antenna is printed on the PCB plated with 35 μm of Cooper
- Track width: 0.8 mm
- Space: 0.5 mm
- Coil: 5 μH

10. Characterized at room temperature only.

N24RF04E

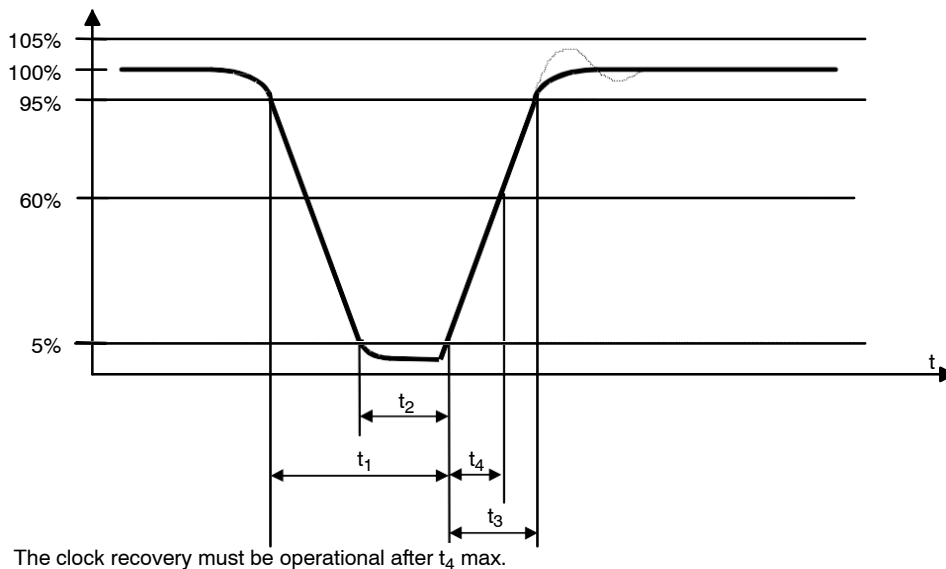

Figure 2. 100% Modulation Waveform

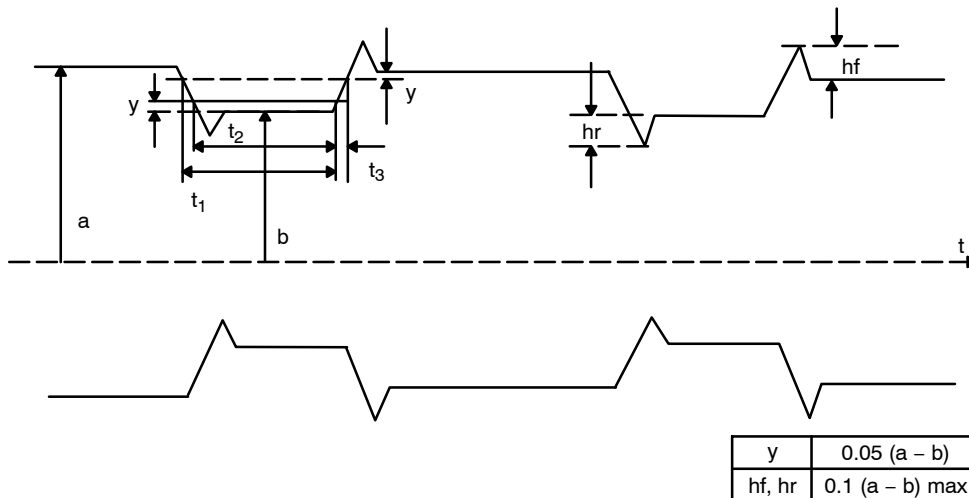

Figure 3. 10% Modulation Waveform

Power-On Reset (POR)

The N24RF04E incorporates Power-On Reset (POR) circuitry which protects the internal logic against powering up in the wrong state. The N24RF04E will power up into Standby mode after V_{CC} exceeds the POR trigger level and will power down into Reset mode when V_{CC} drops below the

POR trigger level. This bi-directional POR behavior protects the device against 'brown-out' failure following a temporary loss of power.

Pin Description

- **SCL:** The Serial Clock input pin accepts the clock signal generated by the Master
- **SDA:** The Serial Data I/O pin accepts input data and delivers output data. In transmit mode, this pin is open drain. Data is acquired on the positive edge, and is delivered on the negative edge of SCL
- **AN1, AN2:** These inputs are used to connect the device to an external antenna. The coil is used to power and access the device through the ISO 15693 and ISO 18000-3 mode 1 RF protocols
- **RF WIP/BUSY:** This configurable output signal is used either to indicate that the N24RF04E is executing an internal write cycle from the RF channel or that an RF command is in progress. RF WIP and signals are available only when the N24RF04E is powered by the V_{CC} pin. It is an open drain output and a pull-up resistor must be connected from RF WIP/BUSY to V_{CC}
- **V_{OUT} :** This analog output pin is used to deliver the analog voltage V_{out} available when the Energy harvesting mode is enabled and the RF field strength is sufficient. When the Energy harvesting mode is disabled or the RF field strength is not sufficient, the energy harvesting analog voltage output V_{out} is in High-Z state

N24RF04E

Functional Description

The N24RF04E is a dual interface RFID/NFC tag with 4 Kb EEPROM.

The device follows the ISO 15693 and ISO 18000–3 mode 1 standard for the radio frequency power and signal interface via the 13.56 MHz carrier. When connected to an antenna coil, no external power supply is required, as the operating power is derived from the RF energy. The communication from the RF Reader to the N24RF04E tag takes place using the ASK modulation with a 1.65 Kb/s data rate using the 1/256 pulse coding or a data rate of 26.48 Kb/s using the 1/4 pulse coding. The communication from the EEPROM tag to the RF reader takes place via load modulation using Manchester coding with 423 kHz and 484 kHz subcarrier frequencies at 6.62 Kb/s or 26.48 Kb/s data rate. The device supports also the 53 Kb/s fast mode.

The N24RF04E supports the Inter-Integrated Circuit (I²C) Bus protocol. The protocol relies on the use of a Master device, which provides the clock and directs bus traffic and Slave devices which execute requests. The N24RF04E operates as a Slave device with a 4-bit device identifier code (1010b) according to the I²C standard definition.

Memory Organization

In the RF mode, the user memory area is organized into 4 sectors of 32 blocks each for a total of 128 blocks x 32 bits. The memory access from the I²C interface is organized as 512 x 8 bits, divided into 4 sectors of 128 bytes each. The user and system memory organization is shown in Figure 4. Each memory sector can be individually read and/or write protected using a specific password. The N24RF04E provides four 32-bit blocks to store three RF password and one I²C password codes.

In RF mode, the read and write access is done by 32-bit block. Read and Write access is controlled by a Sector Security Status (SSS) byte which includes 5 significant bits: Sector Lock bit, two Read / Write protection bits and two Password Control Bits.

In I²C mode, a sector has 128 bytes that can be individually accessed for Read and Write. Each sector can be protected against write operations using the I²C-Write_Lock bit from the 4-bit block area.

The N24RF04E features a 64-bit block to store the 64-bit Unique Identifier (UID) per the ISO 15963 requirements. The UID value is written by ON Semiconductor during manufacturing and it is used during the anti-collision sequence.

The system memory area also includes the application family identifier (AFI) and a data storage family identifier (DSFID) used in the anti-collision algorithm.

The access to the user memory area requires the A2 bit from the Slave address byte (Figure 6) set to “0”. All system memory blocks (Table 8) are accessed with A2 bit set to “1”

Unique Identifier

The N24RF is programmed at the factory with a 64-bit unique identifier. The UID conforms to ISO 15693 / ISO 18000 and is read-only. The UID is comprised of:

- Eight MSBs with a value of 0xE0
- IC manufacturer code for ON Semiconductor 0x67
- Unique 48 bit serial number

MSB					
63	56	55	48	47	0
0xE0		0x67		Unique serial number	

Table 8. SYSTEM MEMORY

I ² C Byte Address		Bits [31:24]	Bits [23:16]	Bits [15:8]	Bits [7:0]
A2=1	0	SSS 3 (00h)	SSS 2 (00h)	SSS 1 (00h)	SSS 0 (00h)
A2=1	2048	-	-	-	I ² C Write Lock [3:0] (00h)
A2=1	2304	I ² C password (0000 0000h)			
A2=1	2308	RF password 1 (0000 0000h)			
A2=1	2312	RF password 2 (0000 0000h)			
A2=1	2316	RF password 3 (0000 0000h)			
A2=1	2320	DSFID (FFh)	AFI (00h)	ON reserved	Configuration byte (F4h)
A2=1	2324	UID	UID	UID	UID
A2=1	2328	UID (E0h)	UID (67h)	UID	UID
A2=1	2332	ON reserved	Mem Size (03 7Fh)		IC Ref (2Eh)
A2=1	2336	-	-	-	Control Register

Sector	Area
0	1 Kbit EEPROM Sector
1	1 Kbit EEPROM Sector
2	1 Kbit EEPROM Sector
3	1 Kbit EEPROM Sector
System	I ² C Password
System	RF Password 1
System	RF Password 2
System	RF Password 3
System	8-bit DSFID
System	8-bit AFI
System	64-bit UID
System	4-bit I ² C Write Lock bits
System	20-bit SSS

Figure 4. Memory Organization

Sector Security Status

The five Sector Security Status bits are organized as follows (Table 9):

Table 9. SECTOR SECURITY STATUS BITS

b4	b3	b2	b1	b0
Password control bits		Read/Write Protection bits		Sector Lock

The Sector Lock bit enables (1) or disables (0) the sector protection. The read/write protection bits (Table 10) determine whether reading and/or writing the sector is permitted. The password control bits (Table 11) determine whether and which password protects the sector.

Table 10. READ/WRITE PROTECTION BITS

Sector Lock (b0)	b2, b1	Sector Access When Password Presented		Sector Access When Password Not Presented	
		Read	Write	Read	Write
0	xx	Read	Write	Read	Write
1	00	Read	Write	Read	No Write
1	01	Read	Write	Read	Write
1	10	Read	Write	No Read	No Write
1	11	Read	No Write	No Read	No Write

Table 11. PASSWORD CONTROL BITS

b4, b3	Password
00	Sector not protected by password
01	Sector protected by Password 1
10	Sector protected by Password 2
11	Sector protected by Password 3

I²C Bus Protocol

The 2-wire I²C bus consists of two lines, SCL and SDA, connected to the V_{CC} supply via pull-up resistors. The Master provides the clock to the SCL line, and either the Master or the Slaves drive the SDA line. A '0' is transmitted by pulling a line LOW and a '1' by letting it stay HIGH. Data transfer may be initiated only when the bus is not busy (see AC Characteristics). During data transfer, SDA must remain stable while SCL is HIGH.

START/STOP Condition

An SDA transition while SCL is HIGH creates a START or STOP condition (Figure 5). The START consists of a HIGH to LOW SDA transition, while SCL is HIGH. Absent the START, a Slave will not respond to the Master. The STOP completes all commands, and consists of a LOW to HIGH SDA transition, while SCL is HIGH.

Device Addressing

The Master addresses a Slave by creating a START condition and then broadcasting an 8-bit Slave address. For the N24RF64, the first four bits of the Slave address are set to 1010. The A2 bit is used to control the access to the user or system memory area. The next 2 bits are set to 11. The R/W bit tells the Slave whether the Master intends to read (1) or write (0) data (Figure 6).

Acknowledge

After processing the Slave address, the Slave responds with an acknowledge (ACK) by pulling down the SDA line during the 9th clock cycle (Figure 7). The Slave will also acknowledge all address bytes and every data byte presented in Write mode if the addressed location is not write protected. In Read mode the Slave shifts out a data byte, and then releases the SDA line during the 9th clock cycle. As long as the Master acknowledges the data, the Slave will continue transmitting. The Master terminates the session by not acknowledging the last data byte (NoACK) and by issuing a STOP condition. Bus timing is illustrated in Figure 8.

N24RF04E

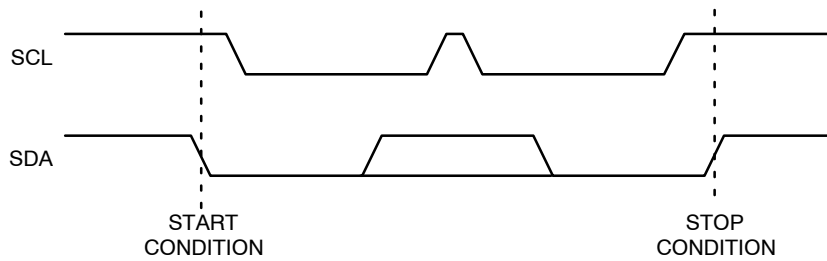
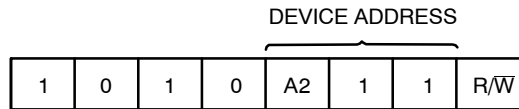

Figure 5. START/STOP Conditions



NOTE: A2 bit is used to control the memory addressing: A2 = 0: User memory area; A2 = 1: System memory area

Figure 6. Slave Address Bits

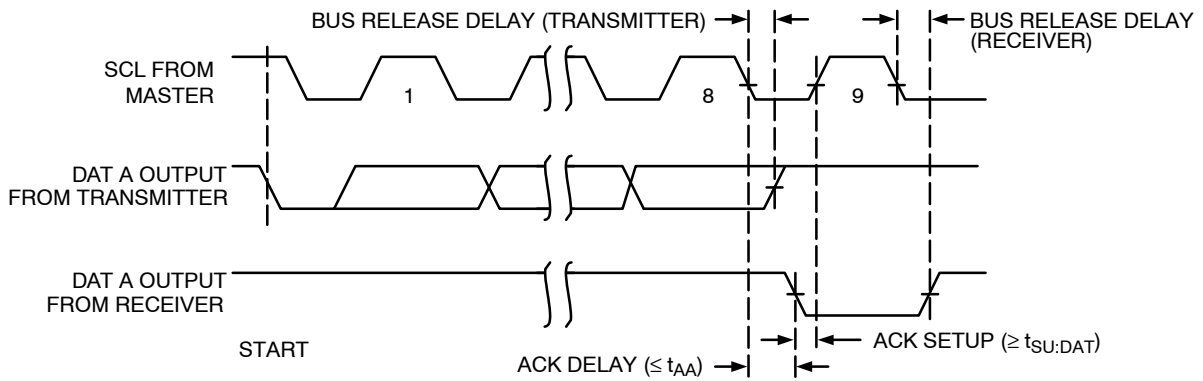

Figure 7. Acknowledge Timing

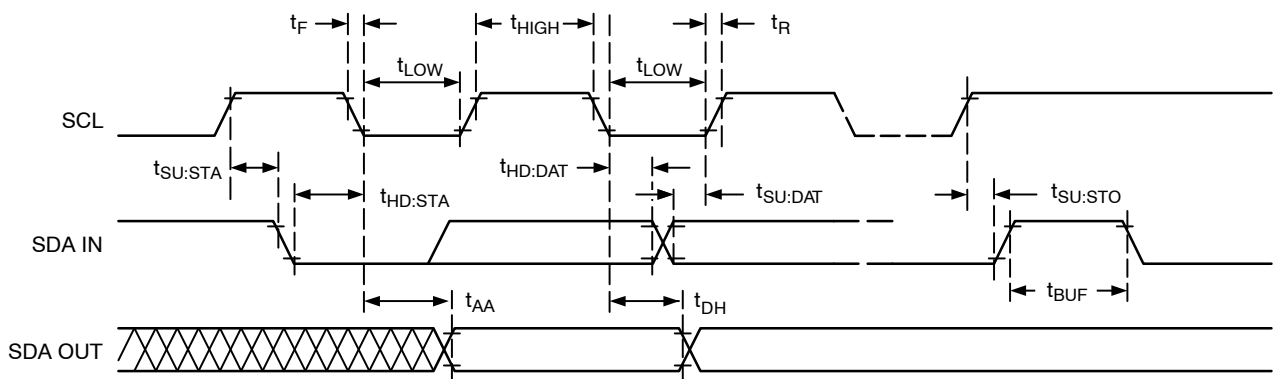

Figure 8. Bus Timing

WRITE OPERATIONS

Byte Write

To write data to memory, the Master creates a START condition on the bus and then broadcasts a Slave address with the R/\overline{W} bit set to '0'. The Master then sends two address bytes and a data byte and concludes the session by creating a STOP condition on the bus. The Slave responds with ACK after every byte sent by the Master (Figure 9). The STOP starts the internal Write cycle, and while this operation is in progress (t_{WR}), the SDA output is tri-stated and the Slave does not acknowledge the Master (Figure 10).

Page Write

The Byte Write operation can be expanded to Page Write, by sending more than one data byte to the Slave before issuing the STOP condition (Figure 11). Up to 4 distinct data bytes can be loaded into the internal Page Write Buffer starting at the address provided by the Master. The page address is latched, and as long as the Master keeps sending

data, the internal byte address is incremented up to the end of page, where it then wraps around (within the page). New data can therefore replace data loaded earlier. Following the STOP, data loaded during the Page Write session will be written to memory in a single internal Write cycle (t_{WR}).

Acknowledge Polling

As soon (and as long) as internal Write is in progress, the Slave will not acknowledge the Master. This feature enables the Master to immediately follow-up with a new Read or Write request, rather than wait for the maximum specified Write time (t_{WR}) to elapse. Upon receiving a NoACK response from the Slave, the Master simply repeats the request until the Slave responds with ACK.

The remainder of the instruction is identical to a normal Page Write.

Delivery State

The N24RF04E is shipped erased, i.e., all bytes from user memory area are FFh.

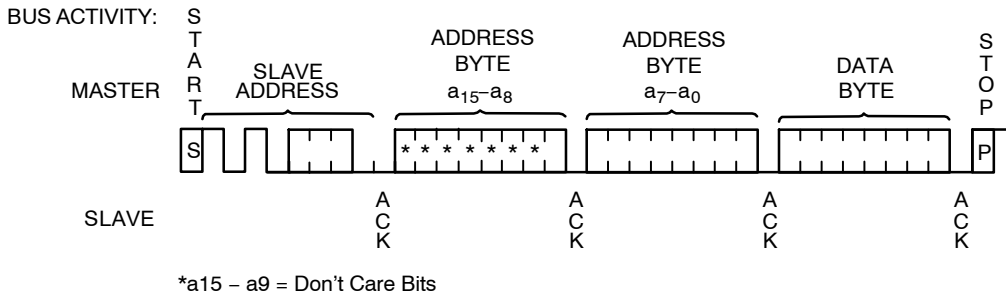

Figure 9. Byte Write Sequence

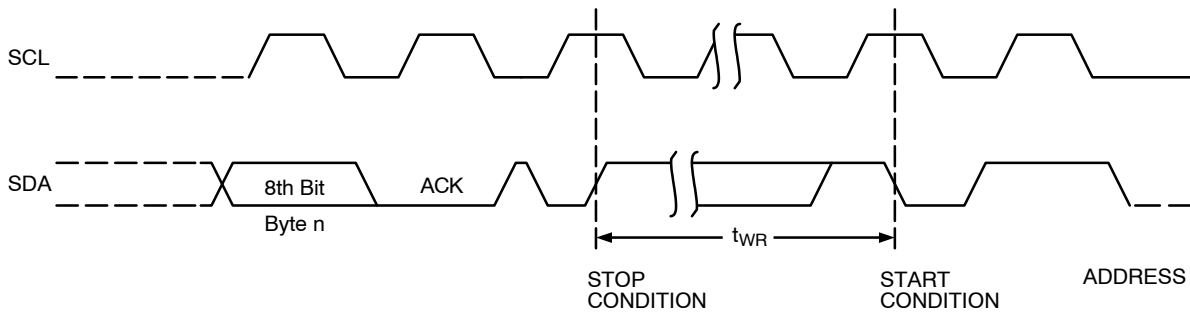

Figure 10. Write Cycle Timing

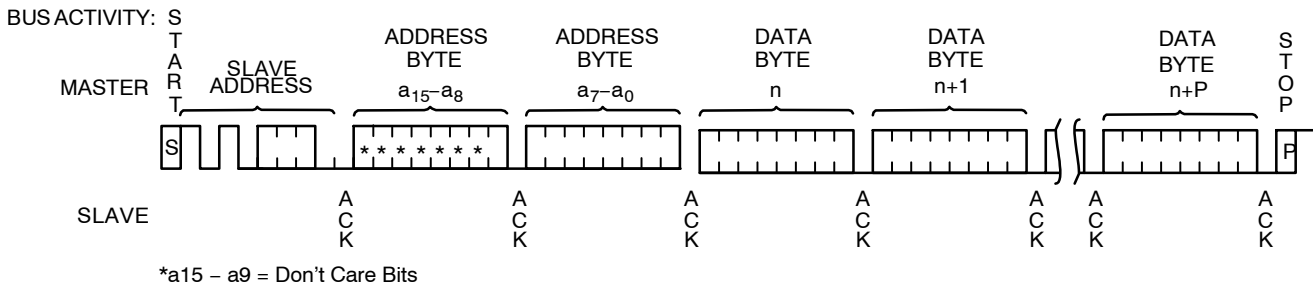

Figure 11. Page Write Sequence

READ OPERATIONS

Immediate Read

To read data from memory, the Master creates a START condition on the bus and then broadcasts a Slave address with the R/\overline{W} bit set to '1'. The Slave responds with ACK and starts shifting out data residing at the current address. After receiving the data, the Master responds with NoACK and terminates the session by creating a STOP condition on the bus (Figure 12). The Slave then returns to Standby mode.

Selective Read

To read data residing at a specific address, the selected address must first be loaded into the internal address register. This is done by starting a Byte Write sequence, whereby the Master creates a START condition, then broadcasts a Slave address with the R/\overline{W} bit set to '0' and then sends two address bytes to the Slave. Rather than completing the Byte Write sequence by sending data, the Master then creates a START condition and broadcasts a Slave address with the R/\overline{W} bit set to '1'. The Slave responds with ACK after every byte sent by the Master and then sends out data residing at the selected address. After receiving the data, the Master responds with NoACK and then terminates the session by creating a STOP condition on the bus (Figure 13).

Sequential Read

If, after receiving data sent by the Slave, the Master responds with ACK, then the Slave will continue transmitting until the Master responds with NoACK followed by STOP (Figure 14). During Sequential Read the internal byte address is automatically incremented up to the end of memory, where it then wraps around to the beginning of memory.

I²C SECURITY

In the I²C mode it is possible to protect each memory sector from user area against write operations. The sector write access is controlled using the 4-bit I2C_Write_Lock bit area and the 32-bit I²C password. There are two commands to control the I²C password: I²C Present Password and I²C Write Password.

I²C Present Password

The I²C Present Password command is used to modify the write access rights of the sectors protected by the I²C Write-Lock bits, including the password itself. N24RF04E will allow this only if the correct password is presented, via I²C bus. If the password is correct, the access rights remain activated until a new I²C Present Password command is received, or the device is powered off.

Following a Start condition, the master sends a write instruction with the slave address with the Read/Write bit

equal to 0 and the A2 bit equal to 1 (system memory). The device acknowledges this and expects two I²C password address bytes, 09h and 00h. The device responds to each address byte with an ACK. The device then expects the 4 password data bytes, the validation code, 09h, and a resend of the 4 password data bytes. The most significant byte of the password is sent first, followed by the least significant bytes.

The 32-bit password must be sent twice to prevent any data corruption during the sequence. If the two 32-bit passwords sent are not exactly the same, the command will not be accepted.

When the bus master generates a Stop condition immediately after the Ack bit, an internal delay equivalent to the write cycle time is triggered. A Stop condition at any other time does not trigger the internal delay. During that delay, the N24RF04E compares the 32 received data bits with the 32 bits of the stored I²C password.

If the values match, the write access rights to all protected sectors are modified after the internal delay. If the values do not match, the protected sectors remains protected.

During the internal delay, the SDA output is tri-stated and the Slave does not acknowledge the Master.

I²C Write Password

The I²C Write Password command is used to overwrite the 32-bit I²C password block. This command is used in I²C mode to update the I²C password value. It cannot be used to modify any of the RF passwords. After the write cycle, the new I²C password value is automatically activated. The I²C password value can only be modified after issuing a valid I²C Present Password command.

Following a Start condition, the master sends a write instruction with the slave address with the Read/Write bit equal to 0 and the A2 bit equal to 1 (system memory). The device acknowledges this and expects two I²C password address bytes, 09h and 00h. The device responds to each address byte with an ACK. The device then expects the 4 password data bytes, the validation code, 07h, and a resend of the 4 password data bytes. The most significant byte of the password is sent first, followed by the least significant bytes. N24RF04E is shipped with the default I²C password 00000000h. By default, the password is activated.

The 32-bit password must be sent twice to prevent any data corruption during the sequence. If the two 32-bit passwords sent are not exactly the same, the command will not be accepted.

When the bus master generates a Stop condition immediately after the Ack bit, the internal write cycle is triggered. A Stop condition at any other time does not trigger the internal write cycle.

During the internal write cycle, the SDA output is tri-stated and the Slave does not acknowledge the Master.

N24RF04E

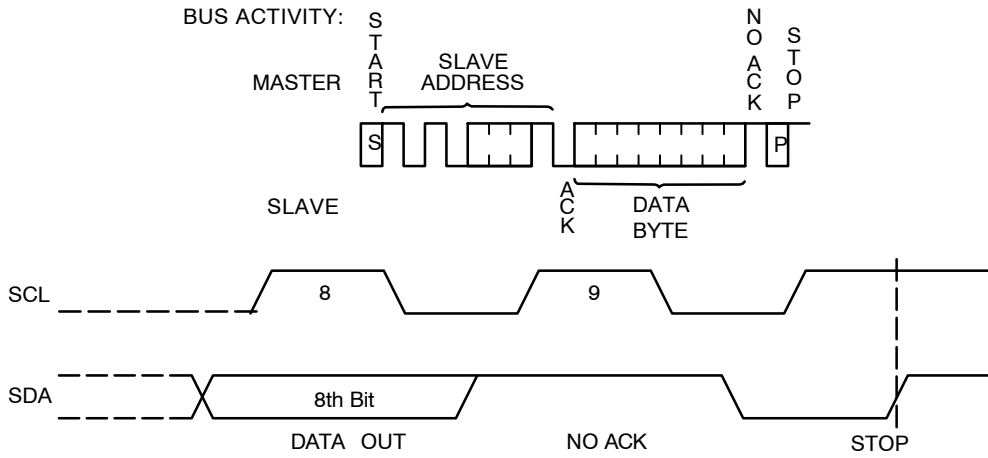

Figure 12. Immediate Read Sequence and Timing

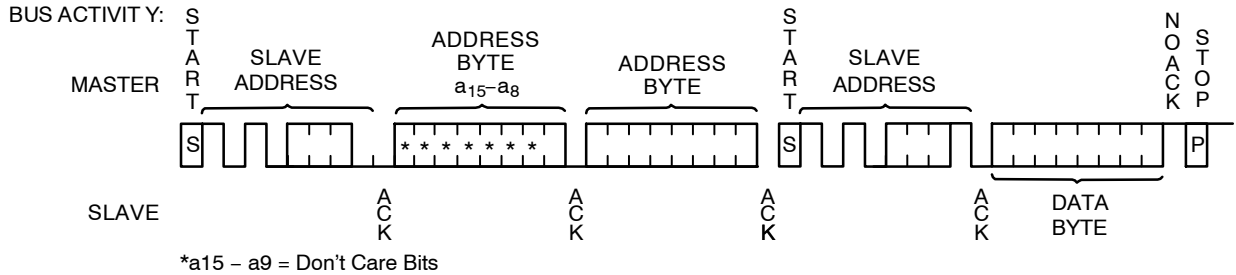

Figure 13. Selective Read Sequence

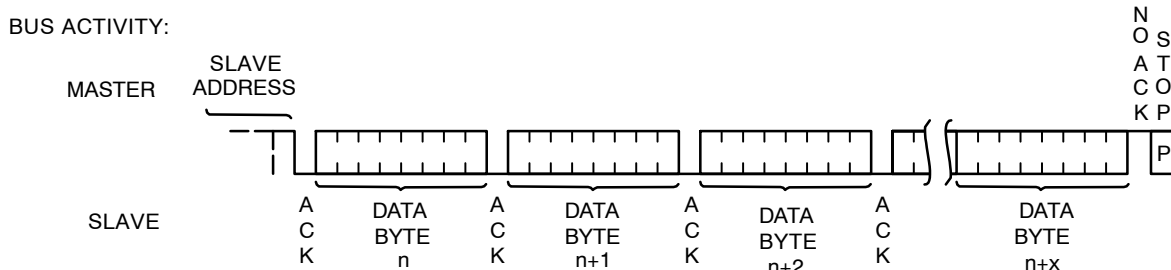

Figure 14. Sequential Read Sequence

Configuration Byte

The configuration byte, as shown in Table 12, contains 8-bit non-volatile.

Table 12. CONFIGURATION BYTE

I ² C byte Address	7	6	5	4	3	2	1	0
A2=1 2320	x	x	x	x	RF WIP/BUSY	EH_mode	EH_cfg1	EH_cfg1

NOTE: bit 4– bit 7 = don't care bits

The EH_cfg0 and EH_cfg1 (Energy Harvesting configuration) bits determine the limit of the current consumption on the V_{OUT} pin. They are set/reset in RF mode by using the WriteEHCfg command.

The typical characteristics of the V_{OUT} vs. I_{Load} for each configuration are shown in Figure 15.

N24RF04E

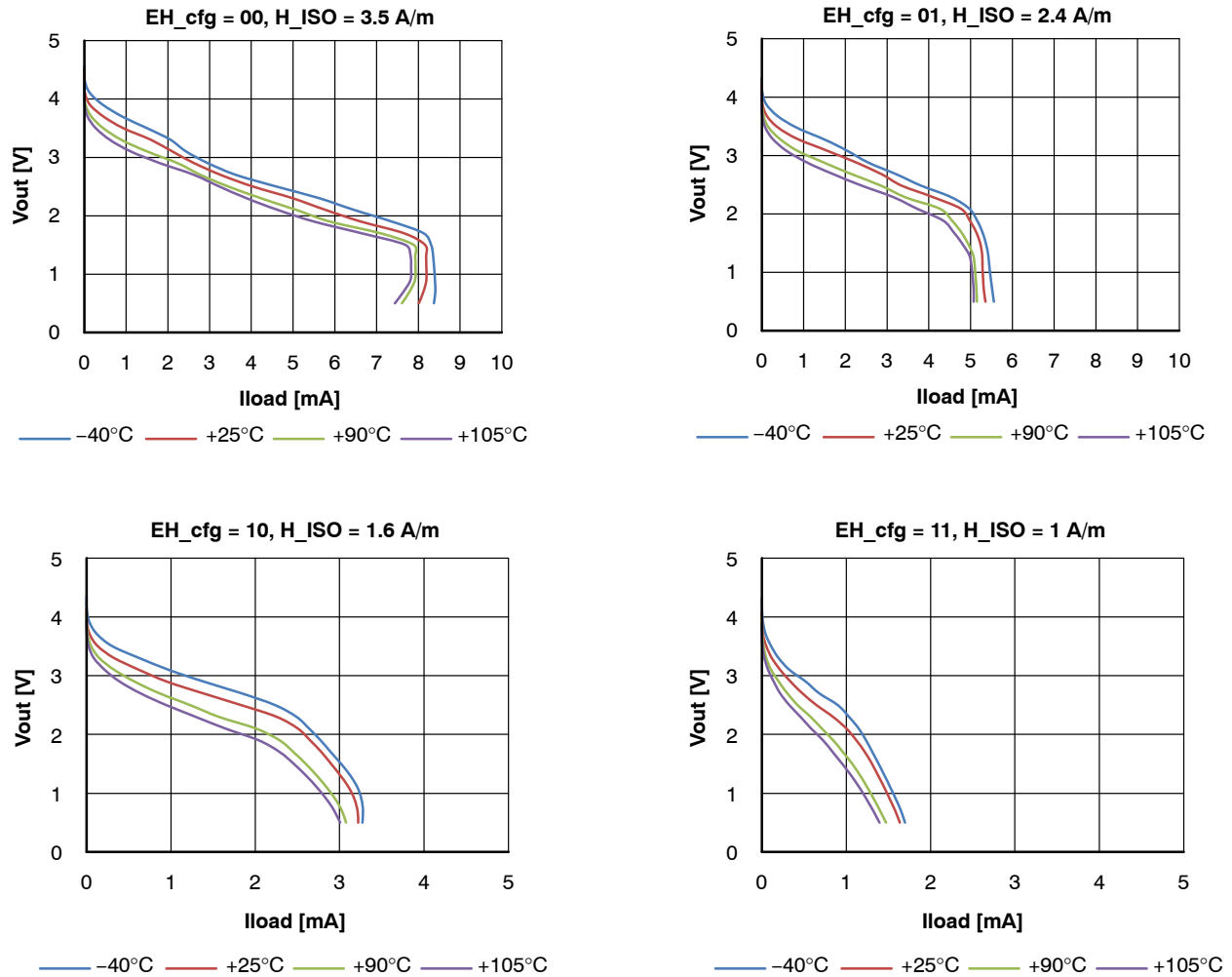

Figure 15. VOUT vs. ILOAD

The EH_mode (Energy Harvesting mode) bit determine the value of the EH_enable bit from the control register after power-up (Table 14). This is set/reset in RF mode by using the WriteEHCfg command.

The RF WIP/BUSY bit is used to configure the RF WIP/BUSY output. When set to 0, the RF WIP/BUSY output is configured in the RF busy mode and the RF WIP/BUSY output is tied to 0 from the SOF until to the end of the RF command. When set to 1, the RF WIP/BUSY output is configured in the RF write in progress mode and the

RF WIP/BUSY output is tied to 0 during an internal write cycle. During an I²C write operation the RF WIP/BUSY output is in High-Z state. This is set/reset in the RF mode by using the WriteDOCfg command.

In the I²C mode, the configuration byte can be read and write by using an I²C instruction.

Control Register

The control register, as shown in Table 13, contains 8-bit volatile.

Table 13. CONTROL REGISTER

I ² C byte Address		7	6	5	4	3	2	1	0
A2=1	2336	WTL	0	0	0	0	0	FIELD_ON	EH_enable

NOTE: bit 1- bit 7 = read-only bits

The EH_enable (Energy Harvesting enable) bit is set/reset by using the SetRstEHEen command in the RF mode or by using a write instruction in the I²C mode. When set to 1, the Energy Harvesting mode is enabling and when set to 0, the Energy Harvesting mode is disabling. After

power-up, this bit is updated according to the value of the EH_mode bit from Configuration byte (Table 12).

The FIELD_ON bit indicates if the RF field is strong enough to execute RF commands. When the FIELD_ON is 1 the N24RF04E is able to execute RF commands and when

N24RF04E

the FIELD_ON is 0 the N24RF04E is not able to execute RF commands.

The WTL (Write Time Latch) bit indicates whether the device has performed a write operation. This bit is automatically reset to 0 at the beginning of each internal

write cycle and set to 1 at the end of the internal write cycle. This bit is read-only and reset to 0 after power-up.

In the I²C mode the control register can be read and write by using an I²C instruction.

Table 14. EH_enable BIT AFTER POWER-UP

EH_mode	EH_enable after Power-up	Energy Harvesting after Power-up
0	1	enabled
1	0	disabled

N24RF04E

RF MODE OPERATION

The communication protocol between the RF Reader and the N24RF04E tag is based on the RTF technique (Reader Talks First):

- Activation of the N24RF04E memory tag by the electromagnetic field of the RF Reader
- Transmission of a command / request by the RF Reader
- Transmission of a response by the memory tag

The memory tag operates continuously under the electromagnetic field (H) generated by the RF Reader. The transmission of data and power is based on inductive coupling using the carrier frequency (f_c) as 13.56 MHz ± 7 kHz per ISO 15693 standard.

Each request from the Reader and each response from the N24RF04E tag are organized in a frame, delimited by a start of frame (SOF) and an end of frame (EOF).

Communication from RF Reader to N24RF04E Tag

The communication between the RF Reader and memory tag uses the ASK (Amplitude Shift Keying) modulation. The received signal is demodulated by the ASK demodulator of the memory tag. The N24RF04E supports both 100% and 10% modulation index. The Reader selects which index is used. Figure 2 shows the 100% ASK modulation waveform.

The data transmission uses pulse position coding described in the ISO 15693: 1 out of 256 data coding with a resulting data rate of 1.65 Kb/s or 1 out of 4 data coding with a data rate of 26.48 Kb/s.

The request from RF Reader to the memory tag consists of: a request SOF, flags, command code, parameters, data, 2-byte CRC, a request EOF. The SOF defines the data coding mode that will be used by the RF Reader for the following command. Figure 16 shows a SOF to select 1 out of 256 data coding and Figure 17 illustrates the SOF to select 1 out of 4.

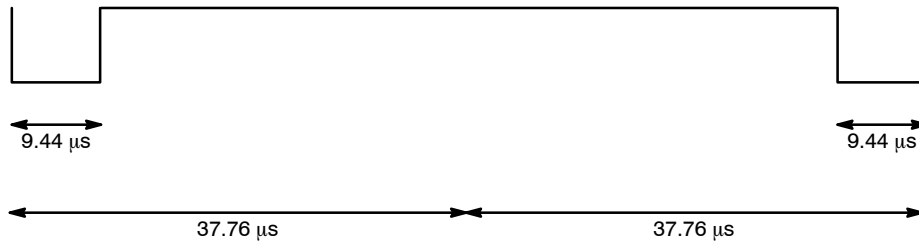

Figure 16. Request SOF for 1 Out of 256 Data Coding

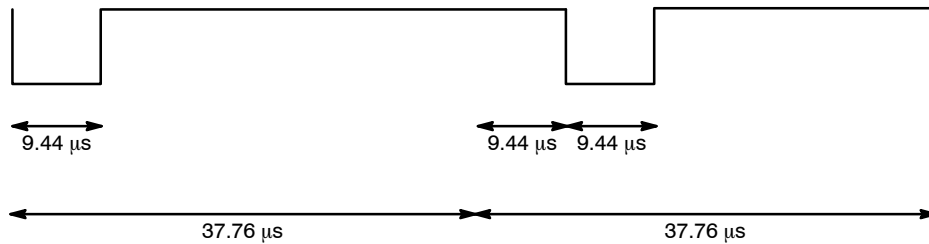

Figure 17. Request SOF for 1 Out of 4 Data Coding

Communication from N24RF64 Tag to RF Reader

The communication between the N24RF04E memory tag and the RF reader uses the load modulation with Manchester data coding. Via the inductive coupling, the carrier is loaded to generate a subcarrier with f_s frequency. The device supports the one-subcarrier with 423.75 kHz ($f_c/32$) frequency and two-subcarrier response with 423.75 kHz ($f_c/32$) and 484.28 kHz ($f_c/28$) frequencies. The one-subcarrier or two-subcarrier response format is selected by the RF Reader.

The N24RF04E responds using the low or high data rate for standard commands. The fast commands use a data rate multiplied by two. The data rate is selected by the RF Reader through the protocol header. Table 15 shows the data rates

supported by the memory tag using one carrier and two carriers format.

Table 15. TAG RESPONSE DATA RATES

Command Type	Data Rate	One-Subcarrier	Two-Subcarrier
Standard Commands	Low	6.62 Kb/s ($f_c/2048$)	6.67 Kb/s ($f_c/2032$)
Fast Commands	Low	13.24 Kb/s ($f_c/1024$)	N/A
Standard Commands	High	26.48 Kb/s ($f_c/512$)	26.69 Kb/s ($f_c/508$)
Fast Commands	High	52.97 Kb/s ($f_c/256$)	N/A

N24RF04E

The N24RF64 supports the following commands in RF mode:

Table 16. RF COMMAND DESCRIPTION

Nr	Command Name	Command Description
1	Inventory	Perform the anticollision sequence
2	Stay quiet	Set the N24RF04E in the quiet state
3	Read single block	Read the requested block
4	Write single block	Write the requested block if it is not locked
5	Read multiple blocks	Read the requested blocks
6	Select	Set the N24RF04E in the selected state
7	Reset to ready	Set the N24RF04E in the ready state
8	Write AFI	Write the AFI register
9	Lock AFI	Lock the AFI register
10	Write DSFID	Write the DSFID register
11	Lock DSFID	Lock the DSFID register.
12	Get system information	Read the system information value
13	Get multiple block security status	Read the sector security status of the requested blocks
14	Write sector password	Write the selected password
15	Lock sector	Write the sector security status bits of the requested sector
16	Present sector password	Allows the user to present a password to unprotect the sectors or to change the password
17	Fast read single block	Read the requested block
18	Fast inventory initiated	Perform the anticollision sequence if the internal initiate flag is set
19	Fast initiate	Set the internal initiate flag
20	Fast read multiple blocks	Read the requested blocks
21	Inventory initiated	Perform the anticollision sequence if the internal initiate flag is set
22	Initiate	Set the internal initiate flag
23	ReadCfg	Read the Configuration byte
24	WriteEHCfg	Write the energy harvesting configuration bits into the Configuration byte
25	SetRstEHEn	Write the EH_enable bit into the Control register
26	CheckEHEn	Read the Control register
27	WriteDOCfg	Write the RF WIP/BUSY bit into the Configuration byte

Table 17. RF COMMAND FORMAT

Nr. Crt.	Function	SOF	Flags	Command	IC Mfg. Code	UID	Optional AFI	Number	Data	CRC16	EOF
1	Inventory	x	8 bits	01h	–	–	8 bits	8 bits (Note 12)	0 to 8 bytes (Note 15)	16 bits	x
2	Stay quiet	x	8 bits	02h	–	8 bytes	–	–	–	16 bits	x
3	Read single block	x	8 bits	20h	–	8 bytes (Note 11)	–	8 bits (Note 13)	–	16 bits	x
4	Write single block	x	8 bits	21H	–	8 bytes (Note 11)	–	8 bits (Note 13)	32 bits	16 bits	x
5	Read multiple blocks	x	8 bits	23H	–	8 bytes (Note 11)	–	8 bits (Note 13)	8 bits (Note 16)	16 bits	x
6	Select	x	8 bits	25h	–	8 bytes	–	–	–	16 bits	x

N24RF04E

Table 17. RF COMMAND FORMAT (continued)

Nr. Crt.	Function	SOF	Flags	Command	IC Mfg. Code	UID	Optional AFI	Number	Data	CRC16	EOF
7	Reset to ready	x	8 bits	26h	–	8 bytes (Note 11)	–	–	–	16 bits	x
8	Write AFI	x	8 bits	27h	–	8 bytes (Note 11)	–	–	8 bits	16 bits	x
9	Lock AFI	x	8 bits	28h	–	8 bytes (Note 11)	–	–	–	16 bits	x
10	Write DSFID	x	8 bits	29h	–	8 bytes (Note 11)	–	–	8 bits	16 bits	x
11	Lock DSFID	x	8 bits	2Ah	–	8 bytes (Note 11)	–	–	–	16 bits	x
12	GET system information	x	8 bits	2Bh	–	8 bytes (Note 11)	–	–	–	16 bits	x
13	Get multiple block security status	x	8 bits	2Ch	–	8 bytes (Note 11)	–	8 bits (Note 13)	8 bits (Note 16)	16 bits	x
14	Write sector password	x	8 bits	B1h	67h	8 bytes (Note 11)	–	8 bits (Note 14)	32 bits	16 bits	x
15	Lock sector	x	8 bits	B2h	67h	8 bytes (Note 11)	–	8 bits (Note 13)	8 bits	16 bits	x
16	Present sector password	x	8 bits	B3h	67h	8 bytes (Note 11)	–	8 bits (Note 14)	32 bits	16 bits	x
17	Fast read single block	x	8 bits	C0h	67h	8 bytes (Note 11)	–	8 bits (Note 13)	–	16 bits	x
18	Fast inventory initiated	x	8 bits	C1h	67h	–	8 bits	8 bits (Note 12)	0 to 8 bytes (Note 15)	16 bits	x
19	Fast initiate	x	8 bits	C2h	67h	–	–	–	–	16 bits	x
20	Fast read multiple blocks	x	8 bits	C3h	67h	8 bytes (Note 11)	–	8 bits (Note 13)	8 bits (Note 16)	16 bits	x
21	Inventory initiated	x	8 bits	D1h	67h	–	8 bits	8 bits (Note 12)	0 to 8 bytes (Note 15)	16 bits	x
22	Initiate	x	8 bits	D2h	67h	–	–	–	–	16 bits	x
23	ReadCfg	x	8 bits	A0h	67h	8 bytes (Note 11)	–	–	–	16 bits	x
24	WriteEHCfg	x	8 bits	A1h	67h	8 bytes (Note 11)	–	–	8 bits	16 bits	x
25	SetRstEHEn	x	8 bits	A2h	67h	8 bytes (Note 11)	–	–	8 bits	16 bits	x
26	CheckEHEn	x	8 bits	A3h	67h	8 bytes (Note 11)	–	–	–	16 bits	x
27	WriteDoCfg	x	8 bits	A4h	67h	8 bytes (Note 11)	–	–	8 bits	16 bits	x

11. UID optional.

12. Mask length.

13. Block number/First block number.

14. Password number.

15. Mask value.

16. Number of blocks.

N24RF04E

Table 18. INSTRUCTION RESPONSE FORMAT (No Error)

Nr. Crt.	Function	SOF	Flags Response	Data Byte	UID	DSFID	AFI	Memory Size	IC Ref	Data	CRC16	EOF
1	Inventory	x	00h	DSFID	8 bytes	-	-	-	-	-	16 bits	x
2	Stay quiet	-	-	-	-	-	-	-	-	-	-	-
3	Read single block	x	00h	SSS (Note 17)	-	-	-	-	-	32 bits	16 bits	x
4	Write single block	x	00h	-	-	-	-	-	-	-	16 bits	x
5	Read multiple blocks	x	00h	SSS (Note 17, 18)	-	-	-	-	-	32 bits (Note 18)	16 bits	x
6	Select	x	00h	-	-	-	-	-	-	-	16 bits	x
7	Reset to ready	x	00h	-	-	-	-	-	-	-	16 bits	x
8	Write AFI	x	00h	-	-	-	-	-	-	-	16 bits	x
9	Lock AFI	x	00h	-	-	-	-	-	-	-	16 bits	x
10	Write DSFID	x	00h	-	-	-	-	-	-	-	16 bits	x
11	Lock DSFID	x	00h	-	-	-	-	-	-	-	16 bits	x
12	Get system information	x	00h	0Fh	8 bytes	8 bits	8 bits	16 bits	8 bits	-	16 bits	x
13	Get multiple block security status	x	00h	SSS (Note 18)	-	-	-	-	-	-	16 bits	x
14	Write sector password	x	00h	-	-	-	-	-	-	-	16 bits	x
15	Lock sector	x	00h	-	-	-	-	-	-	-	16 bits	x
16	Present sector password	x	00h	-	-	-	-	-	-	-	16 bits	x
17	Fast read single block	x	00h	SSS (Note 17)	-	-	-	-	-	32 bits	16 bits	x
18	Fast inventory Initiated	x	00h	DSFID	8 bytes	-	-	-	-	-	16 bits	x
19	Fast initiate	x	00h	DSFID	8 bytes	-	-	-	-	-	16 bits	x
20	Fast read multiple blocks	x	00h	SSS (Note 17, 18)	-	-	-	-	-	32 bits (Note 18)	16 bits	x
21	Inventory initiated	x	00h	DSFID	8 bytes	-	-	-	-	-	16 bits	x
22	Initiate	x	00h	DSFID	8 bytes	-	-	-	-	-	16 bits	x
23	ReadCfg	x	00h	-	-	-	-	-	-	8 bits	16 bits	x
24	WriteEHCfg	x	00h	-	-	-	-	-	-	-	16 bits	x
25	SetRstEHEn	x	00h	-	-	-	-	-	-	-	16 bits	x
26	CheckEHEn	x	00h	-	-	-	-	-	-	8 bits	16 bits	x
27	WriteDoCfg	x	00h	-	-	-	-	-	-	-	16 bits	x

17. SSS optional (FL_OPT = 1).

18. Repeated as needed.

N24RF04E

Table 19. INSTRUCTION RESPONSE FORMAT (Error Flag = 1)

Nr. Crt.	Function	SOF	Flags Response	Error Code	CRC16	EOF
1	Inventory	-	-	-	-	-
2	Stay quiet	-	-	-	-	-
3	Read single block	x	01h	8 bits	16 bits	x
4	Write single block	x	01h	8 bits	16 bits	x
5	Read multiple block	x	01h	8 bits	16 bits	x
6	Select	x	01h	8 bits	16 bits	x
7	Reset to ready	x	01h	8 bits	16 bits	x
8	Write AFI	x	01h	8 bits	16 bits	x
9	Lock AFI	x	01h	8 bits	16 bits	x
10	Write DSFID	x	01h	8 bits	16 bits	x
11	Lock DSFID	x	01h	8 bits	16 bits	x
12	Get system information	x	01h	8 bits	16 bits	x
13	Get multiple block security status	x	01h	8 bits	16 bits	x
14	Write sector password	x	01h	8 bits	16 bits	x
15	Lock sector	x	01h	8 bits	16 bits	x
16	Present sector password	x	01h	8 bits	16 bits	x
17	Fast read single block	x	01h	8 bits	16 bits	x
18	Fast inventory initiated	-	-	-	-	-
19	Fast initiate	-	-	-	-	-
20	Fast read multiple blocks	x	01h	8 bits	16 bits	x
21	Inventory initiated	-	-	-	-	-
22	Initiate	-	-	-	-	-
23	ReadCfg	x	01h	8 bits	16 bits	x
24	WriteEHCfg	x	01h	8 bits	16 bits	x
25	SetRstEHEn	x	01h	8 bits	16 bits	x
26	CheckEHEn	x	01h	8 bits	16 bits	x
27	WriteDoCfg	x	01h	8 bits	16 bits	x

N24RF04E

Table 20. RESPONSE ERROR CODE

Nr. Crt.	Function	Error Code								
		02h	03h	0Fh	10h	11h	12h	13h	14h	15h
1	Inventory	-	-	-	-	-	-	-	-	-
2	Stay quiet	-	-	-	-	-	-	-	-	-
3	Read single block	-	x	-	x	-	-	-	-	x
4	Write single block	-	x	-	x	-	x	x	-	-
5	Read multiple blocks	-	x	x	x	-	-	-	-	x
6	Select	-	x	-	-	-	-	-	-	-
7	Reset to ready	-	x	-	-	-	-	-	-	-
8	Write AFI	-	x	-	-	-	x	x	-	-
9	Lock AFI	-	x	-	-	x	-	-	x	-
10	Write DSFID	-	x	-	-	-	x	x	-	-
11	Lock DSFID	-	x	-	-	x	-	-	x	-
12	Get system information	-	x	-	-	-	-	-	-	-
13	Get multiple block security status	-	x	x	x	-	-	-	-	-
14	Write sector password	x	x	-	x	-	x	x	-	-
15	Lock sector	x	x	-	x	x	-	-	x	-
16	Present sector password	x	x	x	x	-	-	-	-	-
17	Fast read single block	x	x	-	x	-	-	-	-	x
18	Fast inventory initiated	-	-	-	-	-	-	-	-	-
19	Fast initiate	-	-	-	-	-	-	-	-	-
20	Fast read multiple blocks	x	x	x	x	-	-	-	-	x
21	Inventory initiated	-	-	-	-	-	-	-	-	-
22	Initiate	-	-	-	-	-	-	-	-	-
23	ReadCfg	x	x	-	-	-	-	-	-	-
24	WriteEHCfg	x	x	-	-	-	-	x	-	-
25	SetRstEHEn	x	x	-	-	-	-	-	-	-
26	CheckEHEn	x	x	-	-	-	-	-	-	-
27	WriteDoCfg	x	x	-	-	-	-	x	-	-

Table 21. ERROR CODE

Error Code	Meaning
02h	The command is not recognized
03h	The option is not supported
0Fh	Error with no information given
10h	The specified block is not available (doesn't exist)
11h	The specified block is already locked and thus cannot be locked again
12h	The specified block is locked and its content cannot be changed
13h	The specified block was not successfully programmed
14h	The specified block was not successfully locked
15h	The specified block is read-protected

N24RF04E

Table 22. REQUEST FLAGS

Nr. Crt.	Function	Bit 7	Bit 6	Bit 5		Bit 4		Bit 3	Bit 2	Bit 1	Bit 0
		RFU	Option Flag	Address Flag	Nb_Slots Flag	Select Flag	AFI Flag	Protocol Extension Flag	Inventory Flag	Data Rate Flag	Sub – Carrier Flag
1	Inventory	0	0	–	0/1	–	0/1	0	1	0/1	0/1
2	Stay quiet	0	0	1	–	0	–	0	0	0/1	0/1
3	Read single block	0	0/1	0/1	–	0/1	–	0	0	0/1	0/1
4	Write single block	0	0/1	0/1	–	0/1	–	0	0	0/1	0/1
5	Read multiple blocks	0	0/1	0/1	–	0/1	–	0	0	0/1	0/1
6	Select	0	0	1	–	0	–	0	0	0/1	0/1
7	Reset to ready	0	0	0/1	–	0/1	–	0	0	0/1	0/1
8	Write AFI	0	0/1	0/1	–	0/1	–	0	0	0/1	0/1
9	Lock AFI	0	0/1	0/1	–	0/1	–	0	0	0/1	0/1
10	Write DSFID	0	0/1	0/1	–	0/1	–	0	0	0/1	0/1
11	Lock DSFID	0	0/1	0/1	–	0/1	–	0	0	0/1	0/1
12	Get system information	0	0	0/1	–	0/1	–	0	0	0/1	0/1
13	Get multiple block security status	0	0	0/1	–	0/1	–	0	0	0/1	0/1
14	Write sector password	0	0/1	0/1	–	0/1	–	0	0	0/1	0/1
15	Lock sector	0	0/1	0/1	–	0/1	–	0	0	0/1	0/1
16	Present sector password	0	0	0/1	–	0/1	–	0	0	0/1	0/1
17	Fast read single block	0	0/1	0/1	–	0/1	–	0	0	0/1	0
18	Fast inventory initiated	0	0	–	0/1	–	0/1	0	1	0/1	0
19	Fast initiate	0	0	0	–	0	–	0	0	0/1	0
20	Fast read multiple blocks	0	0/1	0/1	–	0/1	–	0	0	0/1	0
21	Inventory initiated	0	0	–	0/1	–	0/1	0	1	0/1	0/1
22	Initiate	0	0	0	–	0	–	0	0	0/1	0/1
23	ReadCfg	0	0	0/1	–	0/1	–	0	0	0/1	0/1
24	WriteEHCfg	0	0/1	0/1	–	0/1	–	0	0	0/1	0/1
25	SetRstEHEn	0	0	0/1	–	0/1	–	0	0	0/1	0/1
26	CheckEHEn	0	0	0/1	–	0/1	–	0	0	0/1	0/1
27	WriteDoCfg	0	0/1	0/1	–	0/1	–	0	0	0/1	0/1

N24RF04E

ORDERING INFORMATION

Device Order Number	Specific Device Marking	Package Type	Temperature Range	Lead Finish	Shipping [†]
N24RF04EDWPT3G	RF04EH	SOIC-8 (Pb-Free)	-40°C to 105°C	NiPdAu	3000 / Tape & Reel
N24RF04EDTPT3G	04EH	TSSOP-8 (Pb-Free)	-40°C to 105°C	NiPdAu	3000 / Tape & Reel

[†]For information on tape and reel specifications, including part orientation and tape sizes, please refer to our Tape and Reel Packaging Specifications Brochure, BRD8011/D.

19. All packages are RoHS-compliant (Pb-Free, Halogen-free).

20. Contact factory for availability.

MECHANICAL CASE OUTLINE
PACKAGE DIMENSIONS



SOIC-8, 150 mils
CASE 751BD
ISSUE O

DATE 19 DEC 2008

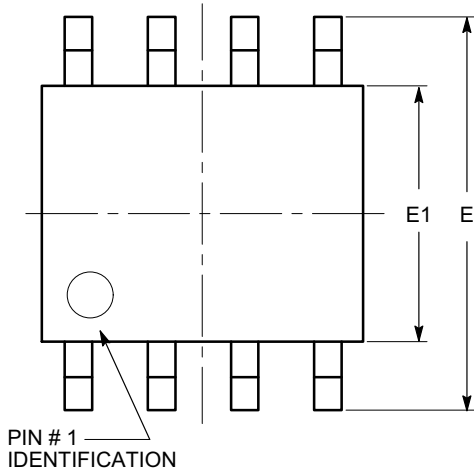

TOP VIEW

SYMBOL	MIN	NOM	MAX
A	1.35		1.75
A1	0.10		0.25
b	0.33		0.51
c	0.19		0.25
D	4.80		5.00
E	5.80		6.20
E1	3.80		4.00
e	1.27 BSC		
h	0.25		0.50
L	0.40		1.27
θ	0°		8°

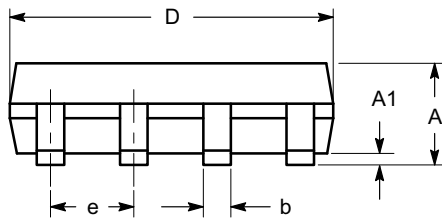

SIDE VIEW

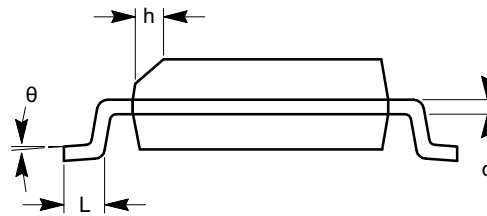

END VIEW

Notes:

- (1) All dimensions are in millimeters. Angles in degrees.
- (2) Complies with JEDEC MS-012.

DOCUMENT NUMBER:	98AON34272E	Electronic versions are uncontrolled except when accessed directly from the Document Repository. Printed versions are uncontrolled except when stamped "CONTROLLED COPY" in red.
DESCRIPTION:	SOIC 8, 150 MILS	PAGE 1 OF 1

onsemi and onsemi are trademarks of Semiconductor Components Industries, LLC dba onsemi or its subsidiaries in the United States and/or other countries. onsemi reserves the right to make changes without further notice to any products herein. onsemi makes no warranty, representation or guarantee regarding the suitability of its products for any particular purpose, nor does onsemi assume any liability arising out of the application or use of any product or circuit, and specifically disclaims any and all liability, including without limitation special, consequential or incidental damages. onsemi does not convey any license under its patent rights nor the rights of others.

MECHANICAL CASE OUTLINE PACKAGE DIMENSIONS

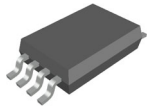

TSSOP8, 4.4x3.0, 0.65P
CASE 948AL
ISSUE A

DATE 20 MAY 2022

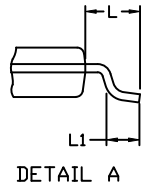
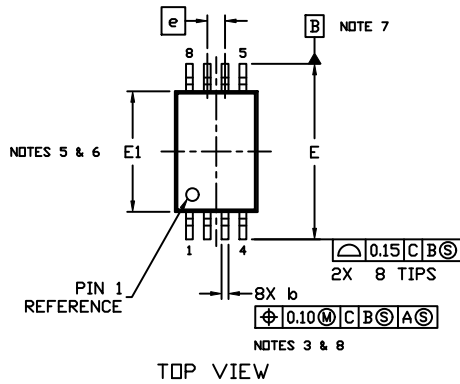

NOTES:

1. DIMENSIONING AND TOLERANCING PER ASME Y14.5, 2009..
2. CONTROLLING DIMENSION: MILLIMETERS
3. DIMENSION *b* DOES NOT INCLUDE DAMBAR PROTRUSION. ALLOWABLE PROTRUSION SHALL NOT BE 0.15 IN EXCESS OF MAXIMUM MATERIAL CONDITION.
4. DIMENSION *D* DOES NOT INCLUDE MOLD FLASH, PROTRUSIONS OR GATE BURRS. MOLD FLASH, PROTRUSIONS OR GATE BURRS SHALL NOT EXCEED 0.15 PER SIDE.
5. DIMENSION *E1* DOES NOT INCLUDE INTERLEAD FLASH OR PROTRUSION. INTERLEAD FLASH OR PROTRUSION SHALL NOT EXCEED 0.25 PER SIDE.
6. THE PACKAGE TOP MAY BE SMALLER THAN THE PACKAGE BOTTOM. DIMENSIONS *D* AND *E1* ARE DETERMINED AT THE OUTERMOST EXTREMES OF THE PLASTIC BODY AT DATUM PLANE *H*.
7. DATUMS *A* AND *B* ARE TO BE DETERMINED AT DATUM *H*.
8. DIMENSIONS *b* AND *c* APPLY TO THE FLAT SECTION OF THE LEAD BETWEEN 0.10 AND 0.25 FROM THE LEAD TIP..
9. *A1* IS DEFINED AS THE LOWEST VERTICAL DISTANCE FROM THE SEATING PLANE TO THE LOWEST POINT ON THE PACKAGE BODY..

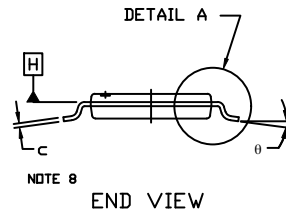
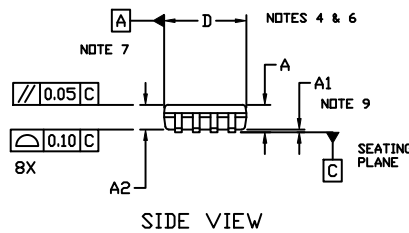

DIM	MILLIMETERS		
	MIN.	NOM.	MAX.
A	---	---	1.20
A1	0.05	---	0.15
A2	0.80	0.90	1.05
<i>b</i>	0.19	---	0.30
<i>c</i>	0.09	---	0.20
D	2.90	3.00	3.10
E	6.30	6.40	6.50
E1	4.30	4.40	4.50
<i>e</i>	0.65 BSC		
L	1.00 REF		
L1	0.50	0.60	0.70
θ	0°	---	8°

GENERIC MARKING DIAGRAM*

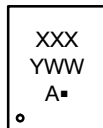

- XXX = Specific Device Code
- Y = Year
- WW = Work Week
- A = Assembly Location
- = Pb-Free Package

*This information is generic. Please refer to device data sheet for actual part marking. Pb-Free indicator, "G" or microdot "▪", may or may not be present. Some products may not follow the Generic Marking.

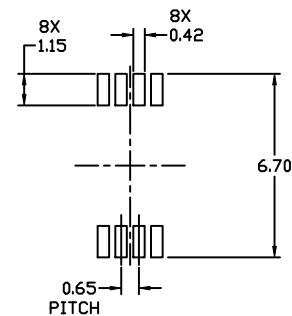

* For additional information on our Pb-Free strategy and soldering details, please download the ON Semiconductor Soldering and Mounting Techniques Reference Manual, SOLDERRM/D.

DOCUMENT NUMBER:	98AON34428E	Electronic versions are uncontrolled except when accessed directly from the Document Repository. Printed versions are uncontrolled except when stamped "CONTROLLED COPY" in red.
DESCRIPTION:	TSSOP8, 4.4X3.0, 0.65P	PAGE 1 OF 1

onsemi and ONSEMI are trademarks of Semiconductor Components Industries, LLC dba onsemi or its subsidiaries in the United States and/or other countries. onsemi reserves the right to make changes without further notice to any products herein. onsemi makes no warranty, representation or guarantee regarding the suitability of its products for any particular purpose, nor does onsemi assume any liability arising out of the application or use of any product or circuit, and specifically disclaims any and all liability, including without limitation special, consequential or incidental damages. onsemi does not convey any license under its patent rights nor the rights of others.

onsemi, **Onsemi**, and other names, marks, and brands are registered and/or common law trademarks of Semiconductor Components Industries, LLC dba "**onsemi**" or its affiliates and/or subsidiaries in the United States and/or other countries. **onsemi** owns the rights to a number of patents, trademarks, copyrights, trade secrets, and other intellectual property. A listing of **onsemi**'s product/patent coverage may be accessed at www.onsemi.com/site/pdf/Patent-Marking.pdf. **onsemi** reserves the right to make changes at any time to any products or information herein, without notice. The information herein is provided "as-is" and **onsemi** makes no warranty, representation or guarantee regarding the accuracy of the information, product features, availability, functionality, or suitability of its products for any particular purpose, nor does **onsemi** assume any liability arising out of the application or use of any product or circuit, and specifically disclaims any and all liability, including without limitation special, consequential or incidental damages. Buyer is responsible for its products and applications using **onsemi** products, including compliance with all laws, regulations and safety requirements or standards, regardless of any support or applications information provided by **onsemi**. "Typical" parameters which may be provided in **onsemi** data sheets and/or specifications can and do vary in different applications and actual performance may vary over time. All operating parameters, including "Typicals" must be validated for each customer application by customer's technical experts. **onsemi** does not convey any license under any of its intellectual property rights nor the rights of others. **onsemi** products are not designed, intended, or authorized for use as a critical component in life support systems or any FDA Class 3 medical devices or medical devices with a same or similar classification in a foreign jurisdiction or any devices intended for implantation in the human body. Should Buyer purchase or use **onsemi** products for any such unintended or unauthorized application, Buyer shall indemnify and hold **onsemi** and its officers, employees, subsidiaries, affiliates, and distributors harmless against all claims, costs, damages, and expenses, and reasonable attorney fees arising out of, directly or indirectly, any claim of personal injury or death associated with such unintended or unauthorized use, even if such claim alleges that **onsemi** was negligent regarding the design or manufacture of the part. **onsemi** is an Equal Opportunity/Affirmative Action Employer. This literature is subject to all applicable copyright laws and is not for resale in any manner.

ADDITIONAL INFORMATION

TECHNICAL PUBLICATIONS:

Technical Library: www.onsemi.com/design/resources/technical-documentation
onsemi Website: www.onsemi.com

ONLINE SUPPORT: www.onsemi.com/support

For additional information, please contact your local Sales Representative at www.onsemi.com/support/sales