

MTP12P10

Preferred Device

Power MOSFET 12 Amps, 100 Volts

P-Channel TO-220

This Power MOSFET is designed for medium voltage, high speed power switching applications such as switching regulators, converters, solenoid and relay drivers.

Features

- Silicon Gate for Fast Switching Speeds – Switching Times Specified at 100°C
- Designer's Data – I_{DSS} , $V_{DS(on)}$, $V_{GS(th)}$ and SOA Specified at Elevated Temperature
- Rugged – SOA is Power Dissipation Limited
- Source-to-Drain Diode Characterized for Use With Inductive Loads
- Pb-Free Package is Available*

MAXIMUM RATINGS ($T_C = 25^\circ\text{C}$ unless otherwise noted)

Rating	Symbol	Value	Unit
Drain-Source Voltage	V_{DSS}	100	Vdc
Drain-Gate Voltage ($R_{GS} = 1.0\text{ M}\Omega$)	V_{DGR}	100	Vdc
Gate-Source Voltage – Continuous – Non-repetitive ($t_p \leq 50\ \mu\text{s}$)	V_{GS} V_{GSM}	± 20 ± 40	Vdc Vpk
Drain Current – Continuous – Pulsed	I_D I_{DM}	12 28	Adc
Total Power Dissipation Derate above 25°C	P_D	75 0.6	W W/°C
Operating and Storage Temperature Range	T_J, T_{stg}	-65 to 150	°C
Thermal Resistance – Junction-to-Case – Junction-to-Ambient	$R_{\theta JC}$ $R_{\theta JA}$	1.67 62.5	°C/W
Maximum Lead Temperature for Soldering Purposes, 1/8" from case for 10 seconds	T_L	260	°C

Stresses exceeding Maximum Ratings may damage the device. Maximum Ratings are stress ratings only. Functional operation above the Recommended Operating Conditions is not implied. Extended exposure to stresses above the Recommended Operating Conditions may affect device reliability.



ON Semiconductor®

<http://onsemi.com>

12 AMPERES, 100 VOLTS

$R_{DS(on)} = 300\text{ m}\Omega$

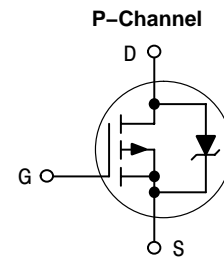

MARKING DIAGRAM AND PIN ASSIGNMENT

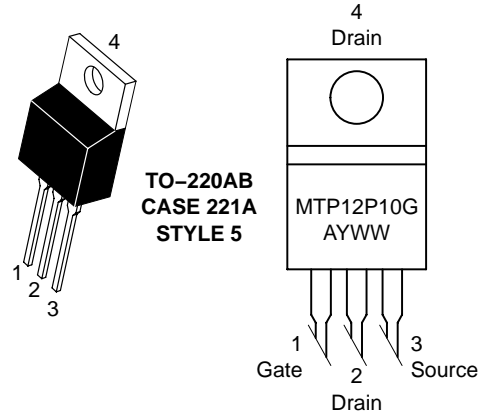

MTP12P10 = Device Code
A = Location Code
Y = Year
WW = Work Week
G = Pb-Free Package

ORDERING INFORMATION

Device	Package	Shipping
MTP12P10	TO-220AB	50 Units/Rail
MTP12P10G	TO-220AB (Pb-Free)	50 Units/Rail

Preferred devices are recommended choices for future use and best overall value.

*For additional information on our Pb-Free strategy and soldering details, please download the ON Semiconductor Soldering and Mounting Techniques Reference Manual, SOLDERRM/D.

MTP12P10

ELECTRICAL CHARACTERISTICS (T_J = 25°C unless otherwise noted)

Characteristic	Symbol	Min	Max	Unit
----------------	--------	-----	-----	------

OFF CHARACTERISTICS

Drain–Source Breakdown Voltage (V _{GS} = 0, I _D = 0.25 mA)	V _{(BR)DSS}	100	–	Vdc
Zero Gate Voltage Drain Current (V _{DS} = Rated V _{DSS} , V _{GS} = 0) (V _{DS} = Rated V _{DSS} , V _{GS} = 0, T _J = 125°C)	I _{DSS}	–	10 100	μAdc
Gate–Body Leakage Current, Forward (V _{GSF} = 20 Vdc, V _{DS} = 0)	I _{GSSF}	–	100	nAdc
Gate–Body Leakage Current, Reverse (V _{GSR} = 20 Vdc, V _{DS} = 0)	I _{GSSR}	–	100	nAdc

ON CHARACTERISTICS (Note 1)

Gate Threshold Voltage (V _{DS} = V _{GS} , I _D = 1.0 mA) T _J = 100°C	V _{GS(th)}	2.0 1.5	4.5 4.0	Vdc
Static Drain–Source On–Resistance (V _{GS} = 10 Vdc, I _D = 6.0 Adc)	R _{DS(on)}	–	0.3	Ω
Drain–Source On–Voltage (V _{GS} = 10 V) (I _D = 12 Adc) (I _D = 6.0 Adc, T _J = 100°C)	V _{DS(on)}	–	4.2 3.8	Vdc
Forward Transconductance (V _{DS} = 15 V, I _D = 6.0 A)	g _{FS}	2.0	–	mhos

DYNAMIC CHARACTERISTICS

Input Capacitance	(V _{DS} = 25 V, V _{GS} = 0, f = 1.0 MHz) See Figure 10	C _{iss}	–	920	pF
Output Capacitance		C _{oss}	–	575	
Reverse Transfer Capacitance		C _{rss}	–	200	

SWITCHING CHARACTERISTICS (Note 1) (T_J = 100°C)

Turn–On Delay Time	(V _{DD} = 25 V, I _D = 0.5 Rated I _D , R _G = 50 Ω) See Figures 12 and 13	t _{d(on)}	–	50	ns
Rise Time		t _r	–	150	
Turn–Off Delay Time		t _{d(off)}	–	150	
Fall Time		t _f	–	150	
Total Gate Charge	(V _{DS} = 0.8 Rated V _{DSS} , I _D = Rated I _D , V _{GS} = 10 V) See Figure 11	Q _g	33 (Typ)	50	nC
Gate–Source Charge		Q _{gs}	16 (Typ)	–	
Gate–Drain Charge		Q _{gd}	17 (Typ)	–	

SOURCE–DRAIN DIODE CHARACTERISTICS (Note 1)

Forward On–Voltage	(I _S = Rated I _D , V _{GS} = 0)	V _{SD}	4.0 (Typ)	5.5	Vdc
Forward Turn–On Time		t _{on}	Limited by stray inductance		
Reverse Recovery Time		t _{rr}	300 (Typ)	–	ns

INTERNAL PACKAGE INDUCTANCE (TO–204)

Internal Drain Inductance, (Measured from the contact screw on the header closer to the source pin and the center of the die)	L _d	5.0 (Typ)	–	nH
Internal Source Inductance (Measured from the source pin, 0.25" from the package to the source bond pad)	L _s	12.5 (Typ)	–	

INTERNAL PACKAGE INDUCTANCE (TO–220)

Internal Drain Inductance (Measured from the contact screw on tab to center of die) (Measured from the drain lead 0.25" from package to center of die)	L _d	3.5 (Typ) 4.5 (Typ)	– –	nH
Internal Source Inductance (Measured from the source lead 0.25" from package to source bond pad)	L _s	7.5 (Typ)	–	

1. Pulse Test: Pulse Width ≤ 300 μs, Duty Cycle ≤ 2%.

MTP12P10

TYPICAL ELECTRICAL CHARACTERISTICS

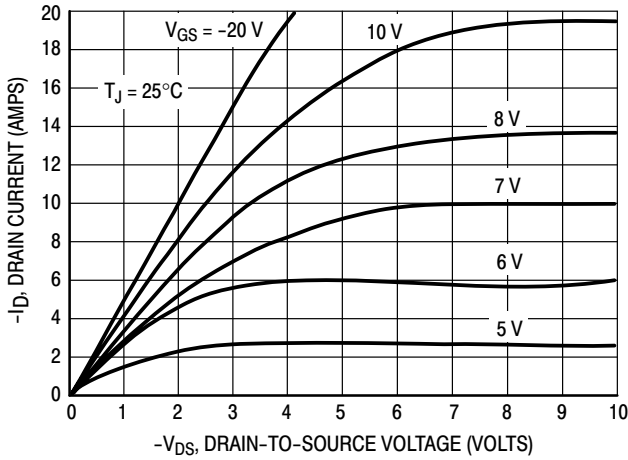

Figure 1. On-Region Characteristics

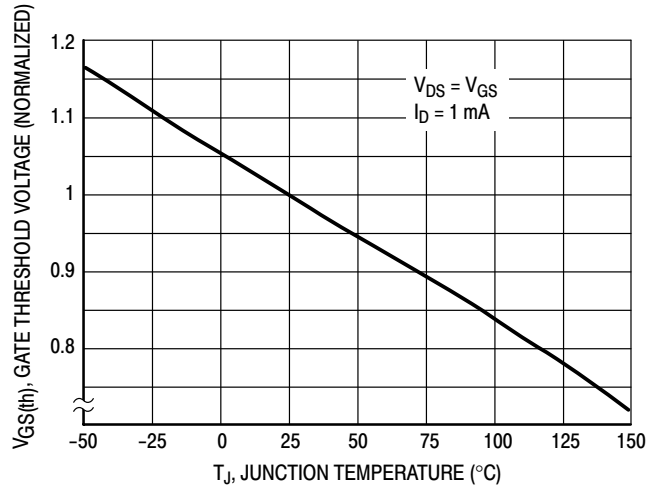

Figure 2. Gate-Threshold Voltage Variation With Temperature

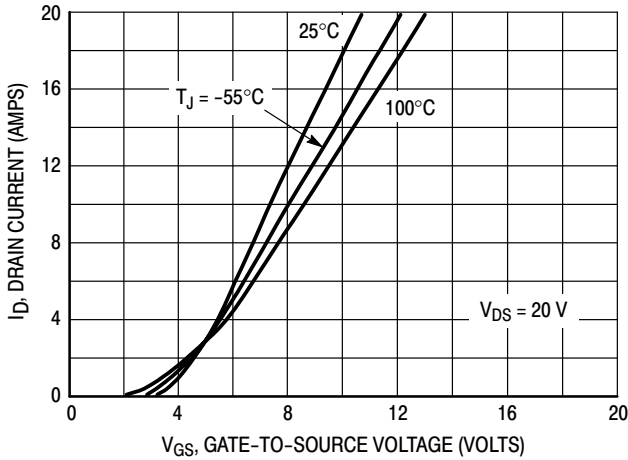

Figure 3. Transfer Characteristics

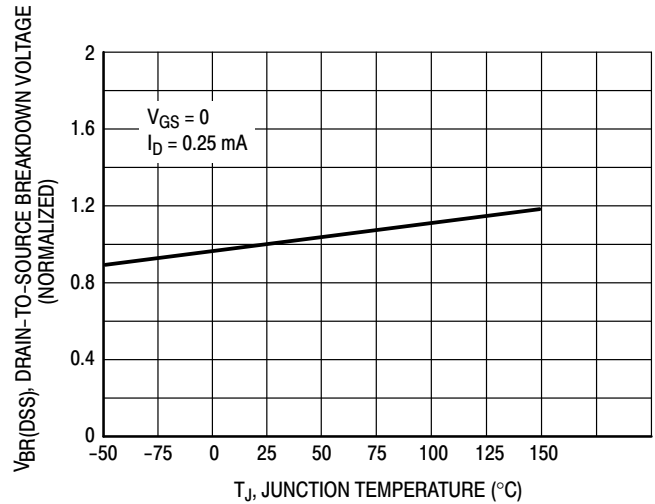

Figure 4. Normalized Breakdown Voltage versus Temperature

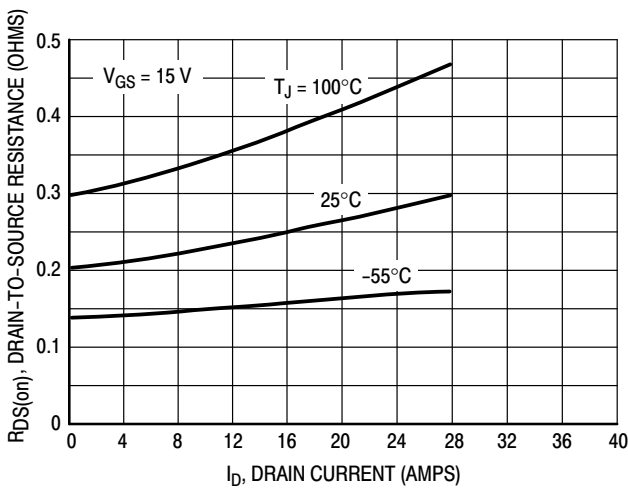

Figure 5. On-Resistance versus Drain Current

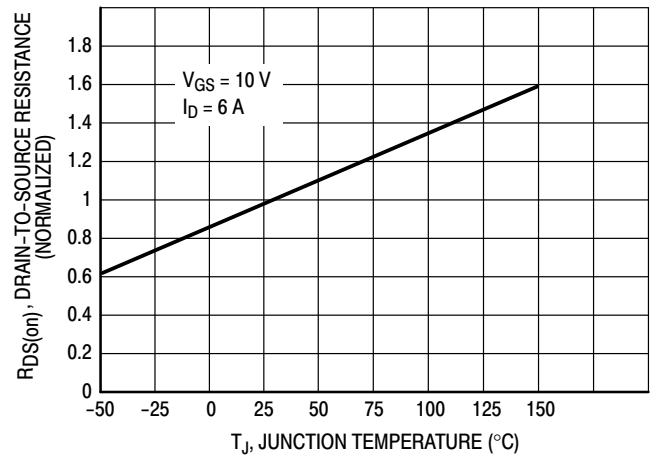

Figure 6. On-Resistance Variation With Temperature

MTP12P10

SAFE OPERATING AREA INFORMATION

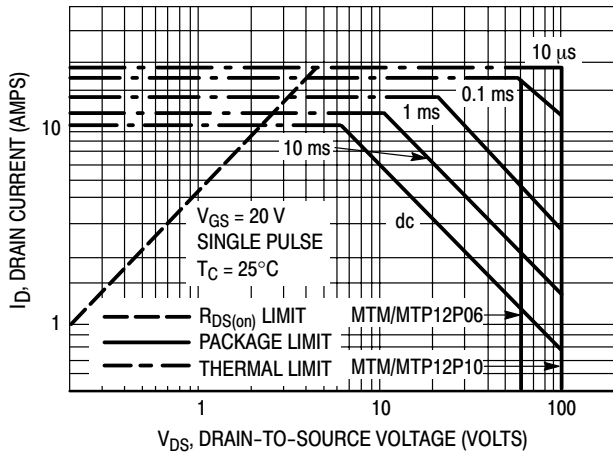

Figure 7. Maximum Rated Forward Biased Safe Operating Area

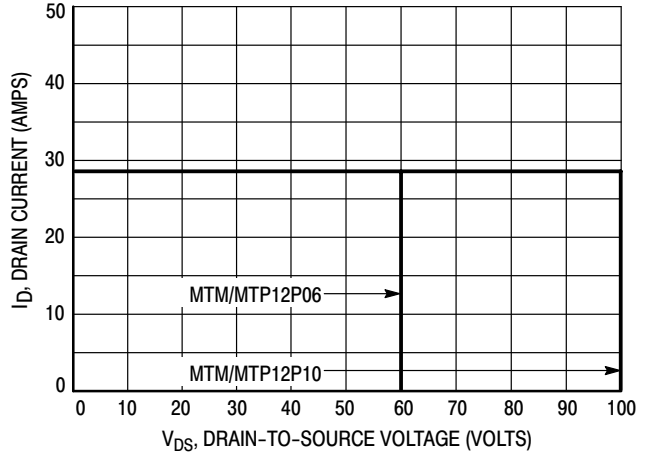

Figure 8. Maximum Rated Switching Safe Operating Area

FORWARD BIASED SAFE OPERATING AREA

The FBSOA curves define the maximum drain-to-source voltage and drain current that a device can safely handle when it is forward biased, or when it is on, or being turned on. Because these curves include the limitations of simultaneous high voltage and high current, up to the rating of the device, they are especially useful to designers of linear systems. The curves are based on a case temperature of 25°C and a maximum junction temperature of 150°C. Limitations for repetitive pulses at various case temperatures can be determined by using the thermal response curves. ON Semiconductor Application Note, AN569, “Transient Thermal Resistance—General Data and Its Use” provides detailed instructions.

SWITCHING SAFE OPERATING AREA

The switching safe operating area (SOA) of Figure 8 is the boundary that the load line may traverse without incurring damage to the MOSFET. The fundamental limits are the peak current, I_{DM} and the breakdown voltage, $V_{(BR)DSS}$. The switching SOA shown in Figure 8 is applicable for both turn-on and turn-off of the devices for switching times less than one microsecond.

The power averaged over a complete switching cycle must be less than:

$$\frac{T_{J(max)} - T_C}{R_{\theta JC}}$$

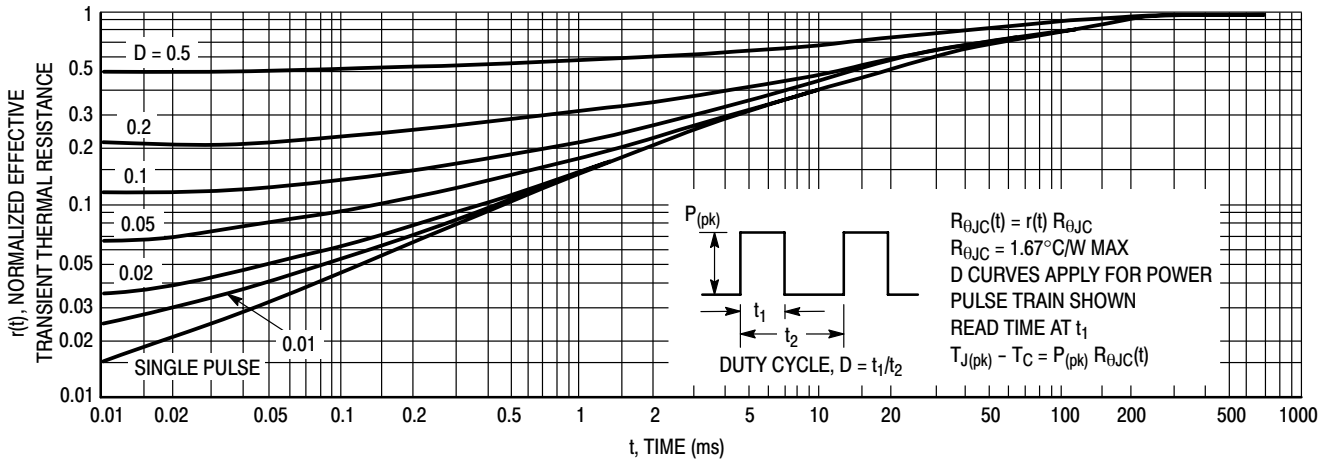

Figure 9. Thermal Response

MTP12P10

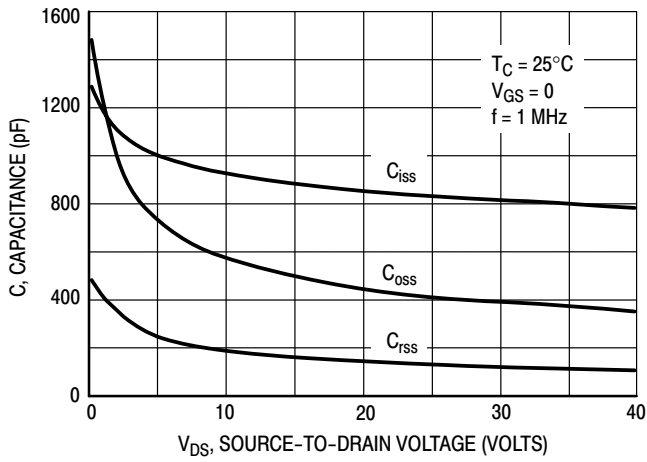

Figure 10. Capacitance Variation

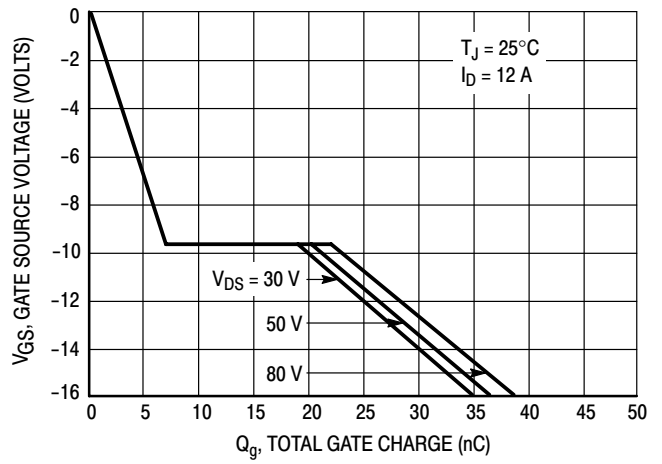

Figure 11. Gate Charge versus Gate-to-Source Voltage

RESISTIVE SWITCHING

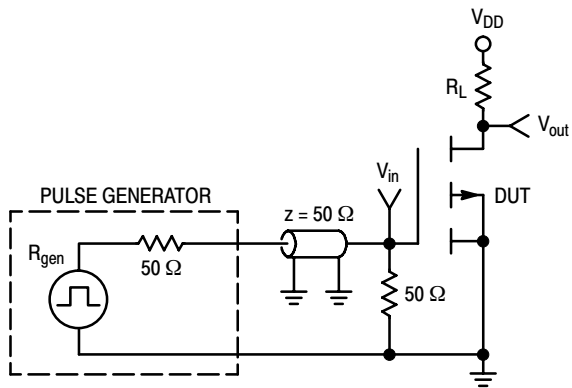

Figure 12. Switching Test Circuit

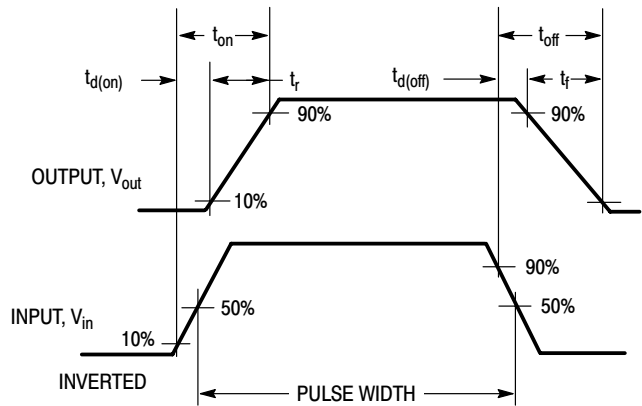

Figure 13. Switching Waveforms

onsemi, **Onsemi**, and other names, marks, and brands are registered and/or common law trademarks of Semiconductor Components Industries, LLC dba "**onsemi**" or its affiliates and/or subsidiaries in the United States and/or other countries. **onsemi** owns the rights to a number of patents, trademarks, copyrights, trade secrets, and other intellectual property. A listing of **onsemi**'s product/patent coverage may be accessed at www.onsemi.com/site/pdf/Patent-Marking.pdf. **onsemi** reserves the right to make changes at any time to any products or information herein, without notice. The information herein is provided "as-is" and **onsemi** makes no warranty, representation or guarantee regarding the accuracy of the information, product features, availability, functionality, or suitability of its products for any particular purpose, nor does **onsemi** assume any liability arising out of the application or use of any product or circuit, and specifically disclaims any and all liability, including without limitation special, consequential or incidental damages. Buyer is responsible for its products and applications using **onsemi** products, including compliance with all laws, regulations and safety requirements or standards, regardless of any support or applications information provided by **onsemi**. "Typical" parameters which may be provided in **onsemi** data sheets and/or specifications can and do vary in different applications and actual performance may vary over time. All operating parameters, including "Typicals" must be validated for each customer application by customer's technical experts. **onsemi** does not convey any license under any of its intellectual property rights nor the rights of others. **onsemi** products are not designed, intended, or authorized for use as a critical component in life support systems or any FDA Class 3 medical devices or medical devices with a same or similar classification in a foreign jurisdiction or any devices intended for implantation in the human body. Should Buyer purchase or use **onsemi** products for any such unintended or unauthorized application, Buyer shall indemnify and hold **onsemi** and its officers, employees, subsidiaries, affiliates, and distributors harmless against all claims, costs, damages, and expenses, and reasonable attorney fees arising out of, directly or indirectly, any claim of personal injury or death associated with such unintended or unauthorized use, even if such claim alleges that **onsemi** was negligent regarding the design or manufacture of the part. **onsemi** is an Equal Opportunity/Affirmative Action Employer. This literature is subject to all applicable copyright laws and is not for resale in any manner.

ADDITIONAL INFORMATION

TECHNICAL PUBLICATIONS:

Technical Library: www.onsemi.com/design/resources/technical-documentation
onsemi Website: www.onsemi.com

ONLINE SUPPORT: www.onsemi.com/support

For additional information, please contact your local Sales Representative at www.onsemi.com/support/sales