

MSC2712GT1G, MSC2712YT1G

General Purpose Amplifier Transistor

NPN Surface Mount

Features

- Moisture Sensitivity Level: 1
- These Devices are Pb-Free, Halogen Free/BFR Free and are RoHS Compliant

MAXIMUM RATINGS ($T_A = 25^\circ\text{C}$)

Rating	Symbol	Value	Unit
Collector-Base Voltage	$V_{(BR)CBO}$	60	Vdc
Collector-Emitter Voltage	$V_{(BR)CEO}$	50	Vdc
Emitter-Base Voltage	$V_{(BR)EBO}$	7.0	Vdc
Collector Current – Continuous	I_C	100	mAdc
Collector Current – Peak	$I_{C(P)}$	200	mAdc

THERMAL CHARACTERISTICS

Characteristic	Symbol	Max	Unit
Power Dissipation	P_D	200	mW
Junction Temperature	T_J	150	$^\circ\text{C}$
Storage Temperature	T_{stg}	-55 to +150	$^\circ\text{C}$

Stresses exceeding those listed in the Maximum Ratings table may damage the device. If any of these limits are exceeded, device functionality should not be assumed, damage may occur and reliability may be affected.



ON Semiconductor®

www.onsemi.com



SC-59
CASE 318D
STYLE 1

MARKING DIAGRAMS

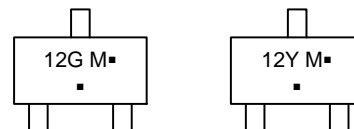

12M, 12Y = Specific Device Code
M = Date Code
▪ = Pb-Free Package
(Note: Microdot may be in either location)

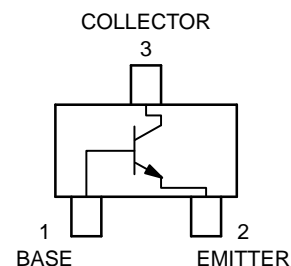

ORDERING INFORMATION

Device	Package	Shipping†
MSC2712GT1G	SC-59 (Pb-Free)	3000 / Tape & Reel
MSC2712YT1G	SC-59 (Pb-Free)	3000 / Tape & Reel

†For information on tape and reel specifications, including part orientation and tape sizes, please refer to our Tape and Reel Packaging Specifications Brochure, BRD8011/D.

MSC2712GT1G, MSC2712YT1G

ELECTRICAL CHARACTERISTICS ($T_A = 25^\circ\text{C}$ unless otherwise noted)

Characteristic	Symbol	Min	Max	Unit
Collector–Emitter Breakdown Voltage ($I_C = 2.0\text{ mAdc}$, $I_E = 0$)	$V_{(BR)CEO}$	50	–	Vdc
Collector–Base Breakdown Voltage ($I_C = 10\ \mu\text{Adc}$, $I_E = 0$)	$V_{(BR)CBO}$	60	–	Vdc
Emitter–Base Breakdown Voltage ($I_E = 10\ \mu\text{Adc}$, $I_C = 0$)	$V_{(BR)EBO}$	7.0	–	Vdc
Collector–Base Cutoff Current ($V_{CB} = 45\text{ Vdc}$, $I_E = 0$)	I_{CBO}	–	0.1	μAdc
Collector–Emitter Cutoff Current ($V_{CE} = 10\text{ Vdc}$, $I_B = 0$) ($V_{CE} = 30\text{ Vdc}$, $I_B = 0$) ($V_{CE} = 30\text{ Vdc}$, $I_B = 0$, $T_A = 80^\circ\text{C}$)	I_{CEO}	– – –	0.1 2.0 1.0	μAdc μAdc mAdc
DC Current Gain (Note 1) ($V_{CE} = 6.0\text{ Vdc}$, $I_C = 2.0\text{ mAdc}$)	h_{FE}			–
		200 120	400 240	
Collector–Emitter Saturation Voltage ($I_C = 100\text{ mAdc}$, $I_B = 10\text{ mAdc}$)	$V_{CE(sat)}$	–	0.5	Vdc
Current – Gain – Bandwidth Product ($I_C = 1\text{ mA}$, $V_{CE} = 10.0\text{ V}$, $f = 10\text{ MHz}$)	f_T	50	–	MHz

Product parametric performance is indicated in the Electrical Characteristics for the listed test conditions, unless otherwise noted. Product performance may not be indicated by the Electrical Characteristics if operated under different conditions.

1. Pulse Test: Pulse Width $\leq 300\ \mu\text{s}$, D.C. $\leq 2\%$.

TYPICAL ELECTRICAL CHARACTERISTICS

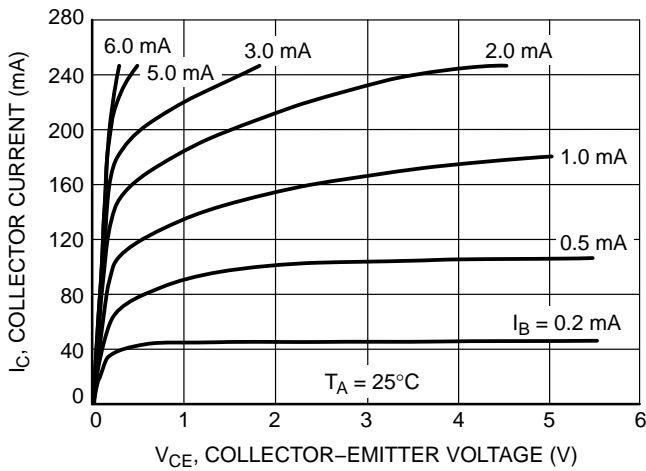

Figure 1. Collector Saturation Voltage

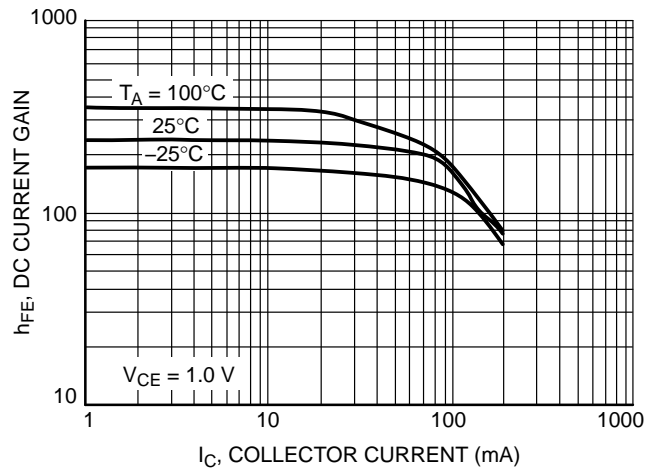

Figure 2. DC Current Gain

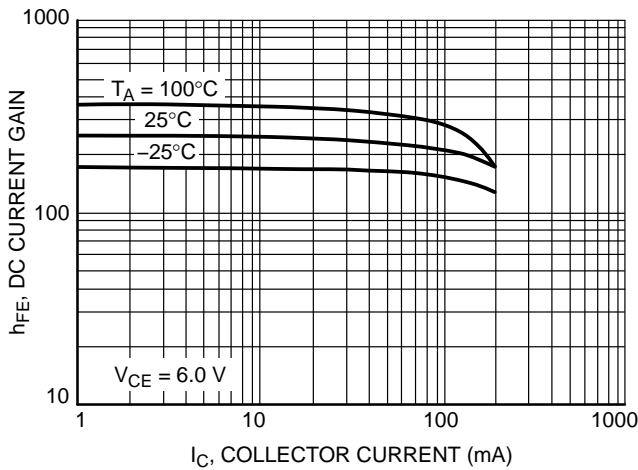

Figure 3. DC Current Gain

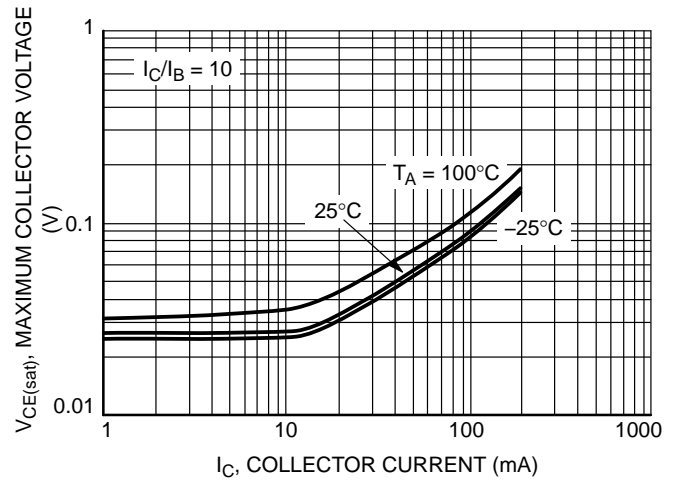

Figure 4. $V_{CE(sat)}$ versus I_C

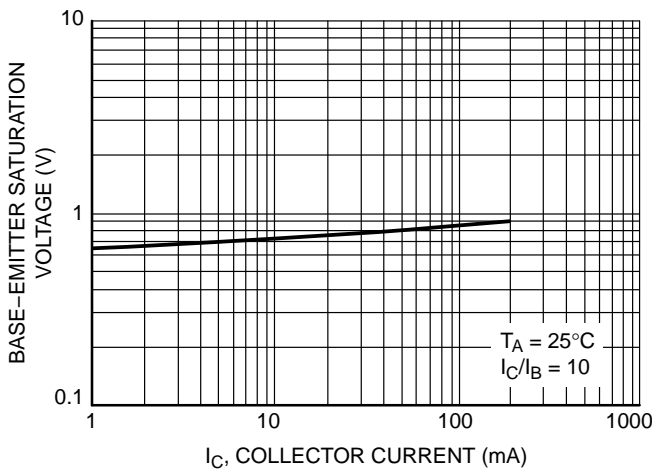

Figure 5. $V_{BE(sat)}$ versus I_C

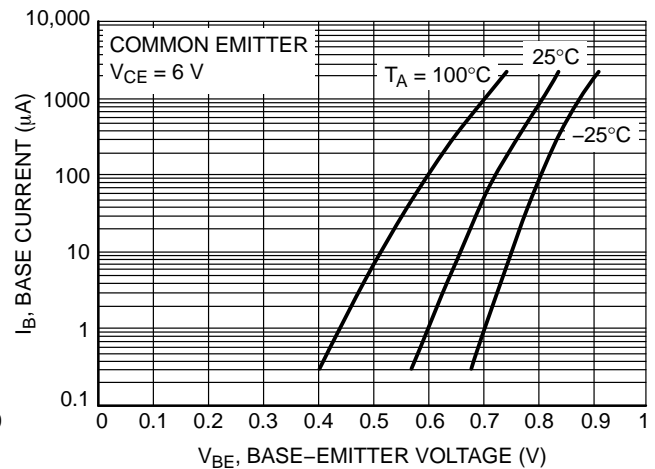

Figure 6. Base-Emitter Voltage

MSC2712GT1G, MSC2712YT1G

TYPICAL ELECTRICAL CHARACTERISTICS

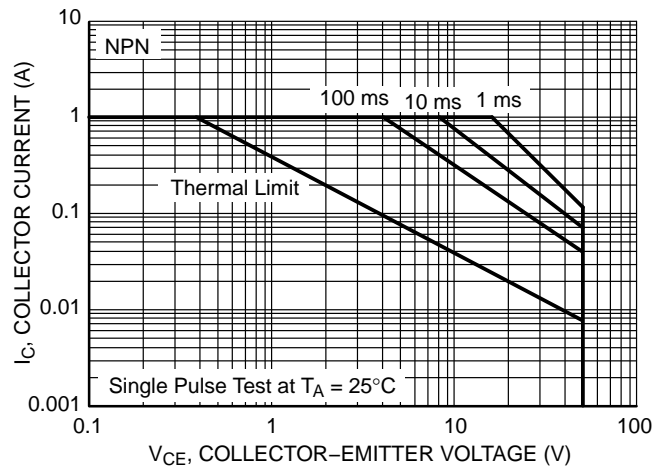

Figure 7. NPN Safe Operating Area

MECHANICAL CASE OUTLINE

PACKAGE DIMENSIONS

ON Semiconductor®



SC-59
CASE 318D-04
ISSUE H

DATE 28 JUN 2012

SCALE 2:1

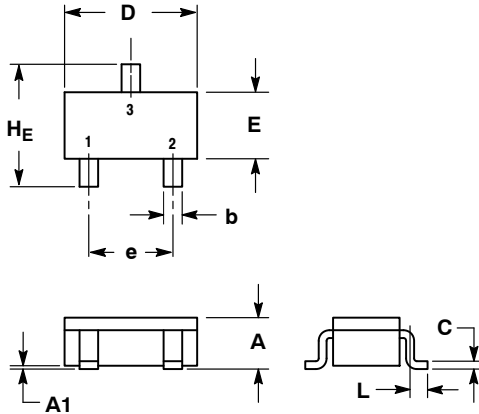

SOLDERING FOOTPRINT*

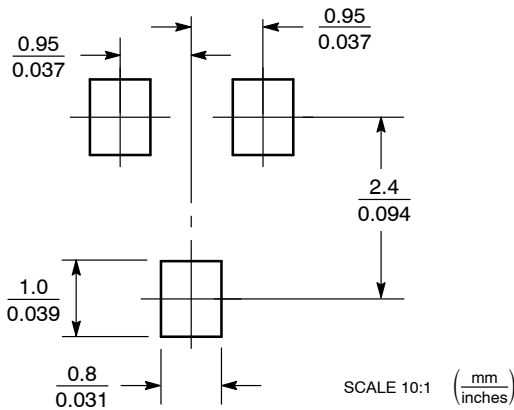

*For additional information on our Pb-Free strategy and soldering details, please download the ON Semiconductor Soldering and Mounting Techniques Reference Manual, SOLDERRM/D.

NOTES:
1. DIMENSIONING AND TOLERANCING PER ANSI Y14.5M, 1982.
2. CONTROLLING DIMENSION: MILLIMETER.

DIM	MILLIMETERS			INCHES		
	MIN	NOM	MAX	MIN	NOM	MAX
A	1.00	1.15	1.30	0.039	0.045	0.051
A1	0.01	0.06	0.10	0.001	0.002	0.004
b	0.35	0.43	0.50	0.014	0.017	0.020
c	0.09	0.14	0.18	0.003	0.005	0.007
D	2.70	2.90	3.10	0.106	0.114	0.122
E	1.30	1.50	1.70	0.051	0.059	0.067
e	1.70	1.90	2.10	0.067	0.075	0.083
L	0.20	0.40	0.60	0.008	0.016	0.024
HE	2.50	2.80	3.00	0.099	0.110	0.118

GENERIC MARKING DIAGRAM

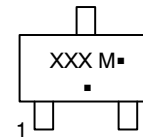

XXX = Specific Device Code
M = Date Code
▪ = Pb-Free Package*

(*Note: Microdot may be in either location)

*This information is generic. Please refer to device data sheet for actual part marking. Pb-Free indicator, "G" or microdot "▪", may or may not be present.

STYLE 1:
PIN 1. BASE
2. EMITTER
3. COLLECTOR

STYLE 2:
PIN 1. ANODE
2. N.C.
3. CATHODE

STYLE 3:
PIN 1. ANODE
2. ANODE
3. CATHODE

STYLE 4:
PIN 1. CATHODE
2. N.C.
3. ANODE

STYLE 5:
PIN 1. CATHODE
2. CATHODE
3. ANODE

STYLE 6:
PIN 1. ANODE
2. CATHODE
3. ANODE/CATHODE

DOCUMENT NUMBER:	98ASB42664B	Electronic versions are uncontrolled except when accessed directly from the Document Repository. Printed versions are uncontrolled except when stamped "CONTROLLED COPY" in red.
DESCRIPTION:	SC-59	PAGE 1 OF 1

ON Semiconductor and ON are trademarks of Semiconductor Components Industries, LLC dba ON Semiconductor or its subsidiaries in the United States and/or other countries. ON Semiconductor reserves the right to make changes without further notice to any products herein. ON Semiconductor makes no warranty, representation or guarantee regarding the suitability of its products for any particular purpose, nor does ON Semiconductor assume any liability arising out of the application or use of any product or circuit, and specifically disclaims any and all liability, including without limitation special, consequential or incidental damages. ON Semiconductor does not convey any license under its patent rights nor the rights of others.

onsemi, **Onsemi**, and other names, marks, and brands are registered and/or common law trademarks of Semiconductor Components Industries, LLC dba "**onsemi**" or its affiliates and/or subsidiaries in the United States and/or other countries. **onsemi** owns the rights to a number of patents, trademarks, copyrights, trade secrets, and other intellectual property. A listing of **onsemi**'s product/patent coverage may be accessed at www.onsemi.com/site/pdf/Patent-Marking.pdf. **onsemi** reserves the right to make changes at any time to any products or information herein, without notice. The information herein is provided "as-is" and **onsemi** makes no warranty, representation or guarantee regarding the accuracy of the information, product features, availability, functionality, or suitability of its products for any particular purpose, nor does **onsemi** assume any liability arising out of the application or use of any product or circuit, and specifically disclaims any and all liability, including without limitation special, consequential or incidental damages. Buyer is responsible for its products and applications using **onsemi** products, including compliance with all laws, regulations and safety requirements or standards, regardless of any support or applications information provided by **onsemi**. "Typical" parameters which may be provided in **onsemi** data sheets and/or specifications can and do vary in different applications and actual performance may vary over time. All operating parameters, including "Typicals" must be validated for each customer application by customer's technical experts. **onsemi** does not convey any license under any of its intellectual property rights nor the rights of others. **onsemi** products are not designed, intended, or authorized for use as a critical component in life support systems or any FDA Class 3 medical devices or medical devices with a same or similar classification in a foreign jurisdiction or any devices intended for implantation in the human body. Should Buyer purchase or use **onsemi** products for any such unintended or unauthorized application, Buyer shall indemnify and hold **onsemi** and its officers, employees, subsidiaries, affiliates, and distributors harmless against all claims, costs, damages, and expenses, and reasonable attorney fees arising out of, directly or indirectly, any claim of personal injury or death associated with such unintended or unauthorized use, even if such claim alleges that **onsemi** was negligent regarding the design or manufacture of the part. **onsemi** is an Equal Opportunity/Affirmative Action Employer. This literature is subject to all applicable copyright laws and is not for resale in any manner.

ADDITIONAL INFORMATION

TECHNICAL PUBLICATIONS:

Technical Library: www.onsemi.com/design/resources/technical-documentation
onsemi Website: www.onsemi.com

ONLINE SUPPORT: www.onsemi.com/support

For additional information, please contact your local Sales Representative at www.onsemi.com/support/sales