

6-Pin DIP Random-Phase Triac Driver Optocoupler (600 Volt Peak)

MOC3051M, MOC3052M, MOC3053M

The MOC3051M, MOC3052M and MOC3053M consist of a GaAs infrared emitting diode optically coupled to a non-zero-crossing silicon bilateral AC switch (triac). These devices isolate low voltage logic from 115 V_{AC} and 240 V_{AC} lines to provide random phase control of high current triacs or thyristors. These devices feature greatly enhanced static dv/dt capability to ensure stable switching performance of inductive loads.

Features

- Excellent I_{FT} Stability—IR Emitting Diode Has Low Degradation
- 600 V Peak Blocking Voltage
- Safety and Regulatory Approvals
 - ◆ UL1577, 4,170 V_{ACRMS} for 1 Minute
 - ◆ DIN EN/IEC60747-5-5

Typical Applications

- Solenoid/Valve Controls
- Lamp Ballasts
- Static AC Power Switch
- Interfacing Microprocessors to 115 V_{AC} and 240 V_{AC} Peripherals
- Solid State Relay
- Incandescent Lamp Dimmers
- Temperature Controls
- Motor Controls

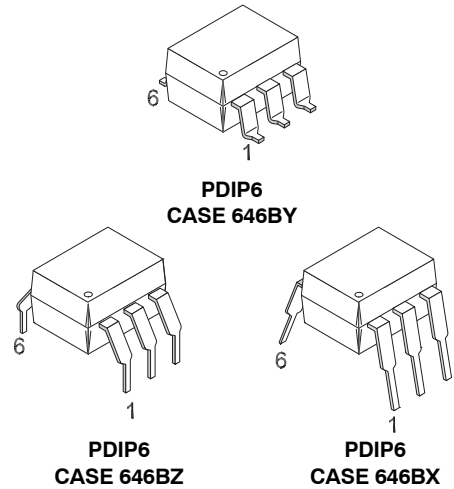

MARKING DIAGRAM

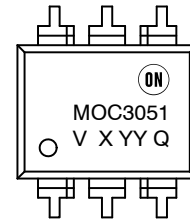

- | | |
|---------|------------------------------|
| ON | = ON Semiconductor Logo |
| MOC3051 | = Device Code |
| V | = DIN EN/IEC60747-5-5 Option |
| X | = One-Digit Year Code |
| YY | = Two-Digit Work Week, |
| Q | = Assembly Package Code |

PIN CONNECTIONS

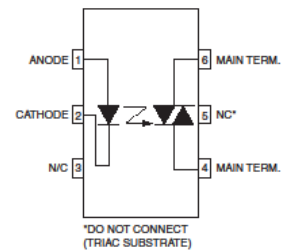

ORDERING INFORMATION

See detailed ordering, marking and shipping information on page 9 of this data sheet.

MOC3051M, MOC3052M, MOC3053M

SAFETY AND INSULATIONS RATINGS

As per DIN EN/IEC 60747-5-5, this optocoupler is suitable for "safe electrical insulation" only within the safety limit data. Compliance with the safety ratings shall be ensured by means of protective circuits.

Parameter	Characteristics	
Installation Classifications per DIN VDE 0110/1.89 Table 1, For Rated Mains Voltage	< 150 V _{RMS}	I-IV
	< 300 V _{RMS}	I-IV
Climatic Classification	40/85/21	
Pollution Degree (DIN VDE 0110/1.89)	2	
Comparative Tracking Index	175	

Symbol	Parameter	Value	Unit
V _{PR}	Input-to-Output Test Voltage, Method A, V _{IORM} × 1.6 = V _{PR} , Type and Sample Test with t _m = 10 s, Partial Discharge < 5 pC	1360	V _{peak}
	Input-to-Output Test Voltage, Method B, V _{IORM} × 1.875 = V _{PR} , 100% Production Test with t _m = 1 s, Partial Discharge < 5 pC	1594	V _{peak}
V _{IORM}	Maximum Working Insulation Voltage	850	V _{peak}
V _{IOTM}	Highest Allowable Over-Voltage	6000	V _{peak}
	External Creepage	≥ 7	mm
	External Clearance	≥ 7	mm
	External Clearance (for Option TV, 0.4" Lead Spacing)	≥ 10	mm
DTI	Distance Through Insulation (Insulation Thickness)	≥ 0.5	mm
R _{IO}	Insulation Resistance at T _S , V _{IO} = 500 V	> 10 ⁹	Ω

MOC3051M, MOC3052M, MOC3053M

MAXIMUM RATINGS $T_A = 25^\circ\text{C}$ unless otherwise specified.

Symbol	Parameter	Value	Unit
TOTAL DEVICE			
T_{STG}	Storage Temperature	-40 to +125	$^\circ\text{C}$
T_{OPR}	Operating Temperature	-40 to +85	$^\circ\text{C}$
T_J	Junction Temperature Range	-40 to +100	$^\circ\text{C}$
T_{SOL}	Lead Solder Temperature	260 for 10 seconds	$^\circ\text{C}$
P_D	Total Device Power Dissipation at 25°C Ambient	330	mW
	Derate Above 25°C	4.4	$\text{mW}/^\circ\text{C}$

EMITTER

I_F	Continuous Forward Current	60	mA
V_R	Reverse Voltage	3	V
P_D	Total Power Dissipation at 25°C Ambient	100	mW
	Derate Above 25°C	1.33	$\text{mW}/^\circ\text{C}$

DETECTOR

V_{DRM}	Off-State Output Terminal Voltage	600	V
I_{TSM}	Peak Non-Repetitive Surge Current (Single Cycle 60 Hz Sine Wave)	1	A
P_D	Total Power Dissipation at 25°C Ambient	300	mW
	Derate Above 25°C	4	$\text{mW}/^\circ\text{C}$

Stresses exceeding those listed in the Maximum Ratings table may damage the device. If any of these limits are exceeded, device functionality should not be assumed, damage may occur and reliability may be affected.

ELECTRICAL CHARACTERISTICS ($T_A = 25^\circ\text{C}$ unless otherwise specified)

INDIVIDUAL COMPONENT CHARACTERISTICS

Symbol	Parameters	Characteristic	Min	Typ	Max	Unit
--------	------------	----------------	-----	-----	-----	------

EMITTER

V_F	Input Forward Voltage	$I_F = 10\text{ mA}$		1.18	1.50	V
I_R	Reverse Leakage Current	$V_R = 3\text{ V}$		0.05	100	μA

DETECTOR

I_{DRM}	Peak Blocking Current, Either Direction	$V_{DRM} = 600\text{ V}$, $I_F = 0$ (Note 1)		10	100	nA
V_{TM}	Peak On-State Voltage, Either Direction	$I_{TM} = 100\text{ mA peak}$, $I_F = 0$		2.2	2.5	V
dv/dt	Critical Rate of Rise of Off-State Voltage	$I_F = 0$, $V_{DRM} = 600\text{ V}$	1000			$\text{V}/\mu\text{s}$

TRANSFER CHARACTERISTICS

Symbol	DC Characteristic	Test Conditions	Device	Min	Typ	Max	Unit
I_{FT}	LED Trigger Current, Either Direction	Main Terminal Voltage = 3 V (Note 2)	MOC3051M			15	mA
			MOC3052M			10	
			MOC3053M			6	
I_H	Holding Current, Either Direction		All		540		μA

MOC3051M, MOC3052M, MOC3053M

ELECTRICAL CHARACTERISTICS ($T_A = 25^\circ\text{C}$ unless otherwise specified) (continued)

INDIVIDUAL COMPONENT CHARACTERISTICS

Symbol	Characteristic	Test Conditions	Min	Typ	Max	Unit
--------	----------------	-----------------	-----	-----	-----	------

ISOLATION CHARACTERISTICS

V_{ISO}	Input-Output Isolation Voltage (Note 3)	$f = 60 \text{ Hz}, t = 1 \text{ Minute}$	4170			$V_{AC_{RMS}}$
R_{ISO}	Isolation Resistance	$V_{I-O} = 500 \text{ V}_{DC}$		10^{11}		Ω
C_{ISO}	Isolation Capacitance	$V = 0 \text{ V}, f = 1 \text{ MHz}$		0.2		pF

- Test voltage must be applied within dv/dt rating.
- All devices will trigger at an I_F value greater than or equal to the maximum I_{FT} specification. For optimum operation over temperature and lifetime of the device, the LED should be biased with an I_F that is at least 50% higher than the maximum I_{FT} specification. The I_F should not exceed the absolute maximum rating of 60 mA.
Example: For MOC3052M, the minimum I_F bias should be $10 \text{ mA} \times 150\% = 15 \text{ mA}$.
- Isolation voltage, V_{ISO} , is an internal device dielectric breakdown rating. For this test, pins 1 and 2 are common, and pins 4, 5 and 6 are common.

TYPICAL CHARACTERISTICS

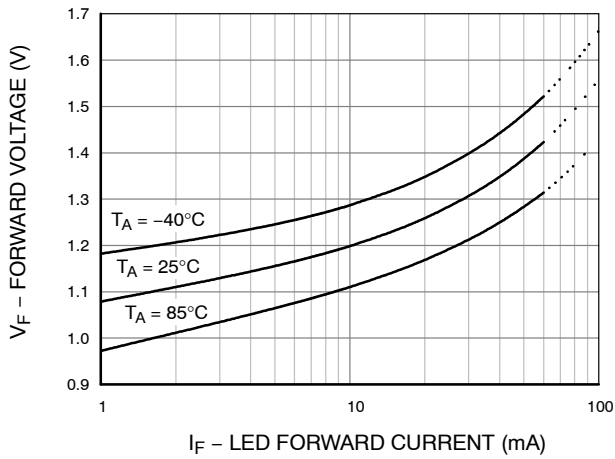

Figure 1. LED Forward Voltage vs. Forward Current

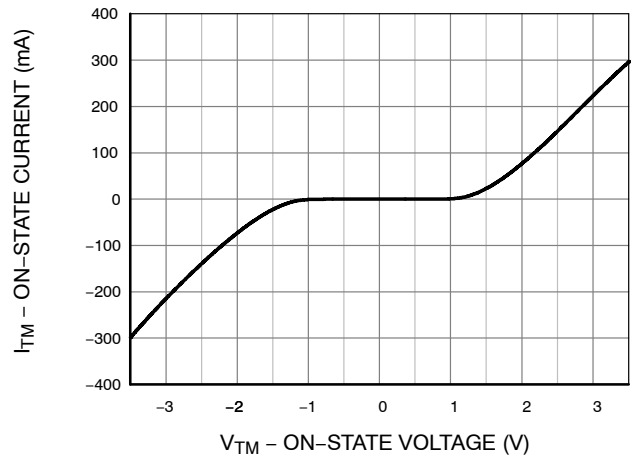

Figure 2. On-State Characteristics

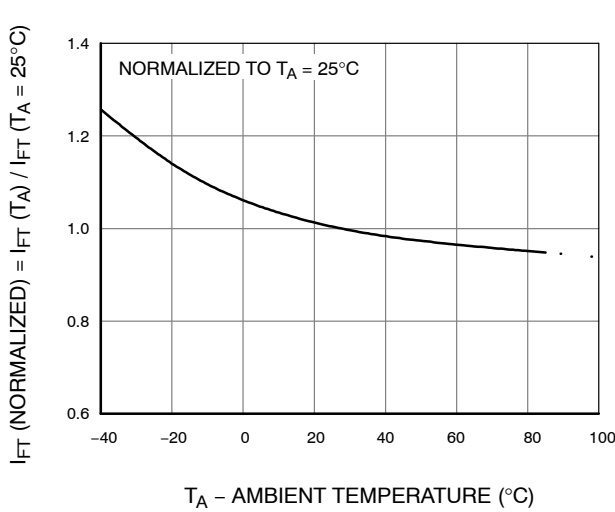

Figure 3. LED Trigger Current vs. Ambient Temperature

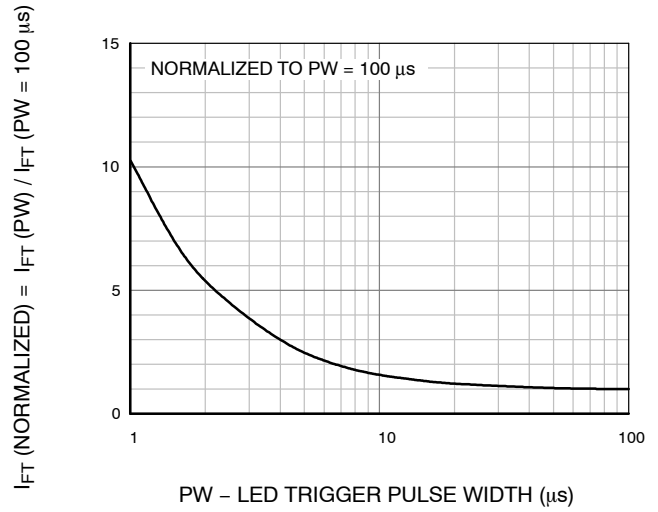

Figure 4. LED Trigger Current vs. LED Pulse Width

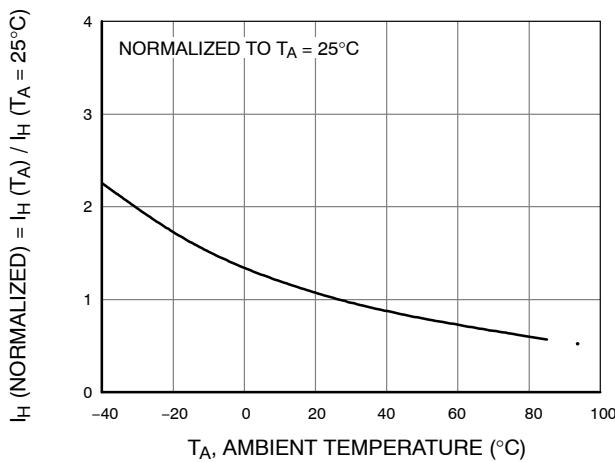

Figure 5. Holding Current vs. Ambient Temperature

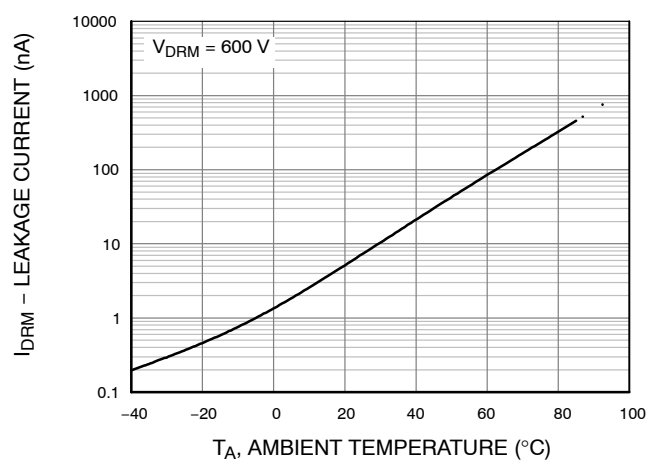

Figure 6. Leakage Current vs. Ambient Temperature

APPLICATIONS INFORMATION

Basic Triac Driver Circuit

The random phase triac drivers MOC3051M, MOC3052M and MOC3053M can allow snubberless operations in applications where load is resistive and the external generated noise in the AC line is below its guaranteed dv/dt withstand capability. For these applications, a snubber circuit is not necessary when a noise insensitive power triac is used. Figure 7 shows the circuit diagram. The triac driver is directly connected to the triac main terminal 2 and a series resistor R which limits the current to the triac driver. Current limiting resistor R must have a minimum value which restricts the current into the driver to maximum 1 A.

The power dissipation of this current limiting resistor and the triac driver is very small because the power triac carries the load current as soon as the current through driver and current limiting resistor reaches the trigger current of the power triac. The switching transition times for the driver is only one micro second and for power triacs typical four micro seconds.

Triac Driver Circuit for Noisy Environments

When the transient rate of rise and amplitude are expected to exceed the power triacs and triac drivers maximum ratings a snubber circuit as shown in Figure 8 is recommended. Fast transients are slowed by the R-C snubber and excessive amplitudes are clipped by the Metal Oxide Varistor MOV.

Triac Driver Circuit for Extremely Noisy Environments

As specified in the noise standards IEEE472 and IEC255-4.

Industrial control applications do specify a maximum transient noise dv/dt and peak voltage which is super-imposed onto the AC line voltage. In order to pass this environment noise test a modified snubber network as shown in Figure 9 is recommended.

LED Trigger Current versus Temperature

Recommended operating LED control current I_F lies between the guaranteed I_{FT} and absolute maximum I_F . Figure 3 shows the increase of the trigger current when the device is expected to operate at an ambient temperature below 25°C. Multiply the datasheet guaranteed I_{FT} with the normalized I_{FT} shown on this graph and an allowance for LED degradation over time.

Example:

$$I_{FT} = 10 \text{ mA, LED degradation factor} = 20\%$$

$$I_F \text{ at } -40^\circ\text{C} = 10 \text{ mA} \times 1.25 \times 120\% = 15 \text{ mA}$$

LED Trigger Current vs. Pulse Width

Random phase triac drivers are designed to be phase controllable. They may be triggered at any phase angle within the AC sine wave. Phase control may be accomplished by an AC line zero cross detector and a variable pulse delay generator which is synchronized to the zero cross detector. The same task can be accomplished by a microprocessor which is synchronized to the AC zero crossing. The phase controlled trigger current may be a very short pulse which saves energy delivered to the input LED. LED trigger pulse currents shorter than 100 μs must have increased amplitude as shown on Figure 4. This graph shows the dependency of the trigger current I_{FT} versus the pulse width. I_{FT} in this graph is normalized in respect to the minimum specified I_{FT} for static condition, which is specified in the device characteristic. The normalized I_{FT} has to be multiplied with the devices guaranteed static trigger current.

Example:

$$I_{FT} = 10 \text{ mA, Trigger PW} = 4 \mu\text{s}$$

$$I_F \text{ (pulsed)} = 10 \text{ mA} \times 3 = 30 \text{ mA}$$

Minimum LED Off Time in Phase Control Applications

In phase control applications, one intends to be able to control each AC sine half wave from 0° to 180°. Turn on at 0° means full power and turn on at 180° means zero power. This is not quite possible in reality because triac driver and triac have a fixed turn on time when activated at zero degrees. At a phase control angle close to 180° the driver's turn on pulse at the trailing edge of the AC sine wave must be limited to end 200 μs before AC zero cross as shown in Figure 10. This assures that the triac driver has time to switch off. Shorter times may cause loss of control at the following half cycle.

Static dv/dt

Critical rate of rise of off-state voltage or static dv/dt is a triac characteristic that rates its ability to prevent false triggering in the event of fast rising line voltage transients when it is in the off-state. When driving a discrete power triac, the triac driver optocoupler switches back to off-state once the power triac is triggered. However, during the commutation of the power triac in application where the load is inductive, both triacs are subjected to fast rising voltages. The static dv/dt rating of the triac driver optocoupler and the commutating dv/dt rating of the power triac must be taken into consideration in snubber circuit design to prevent false triggering and commutation failure.

MOC3051M, MOC3052M, MOC3053M

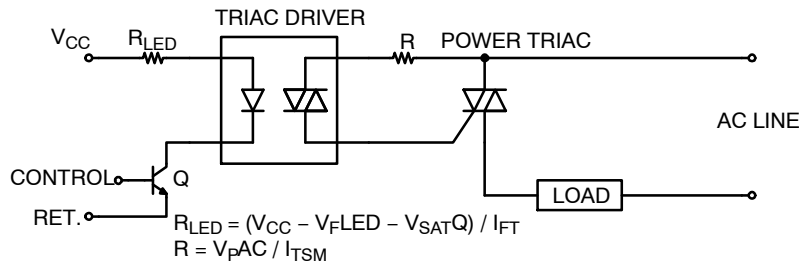
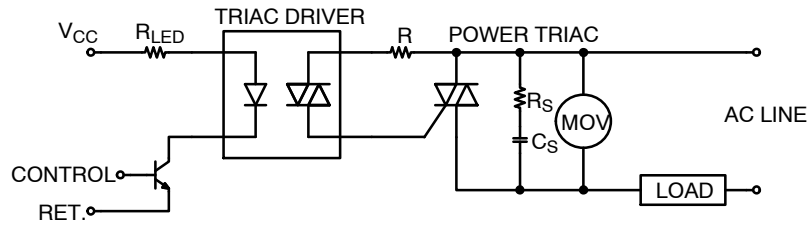
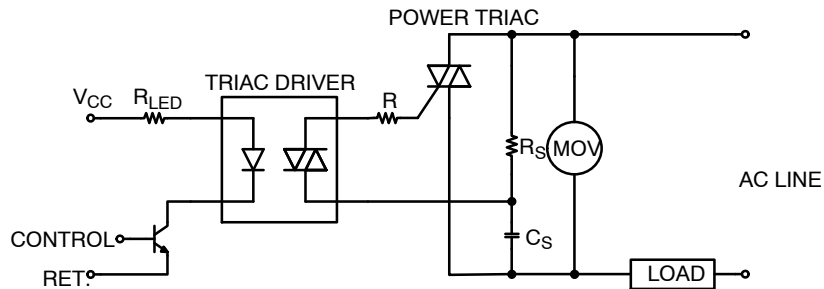

Figure 7. Basic Driver Circuit



Typical Snubber values $R_S = 33 \Omega$, $C_S = 0.01 \mu F$
 MOV (Metal Oxide Varistor) protects power triac and driver from transient overvoltages $> V_{DRM \max}$

Figure 8. Triac Driver Circuit for Noisy Environments



Recommended snubber to pass IEEE472 and IEC255-4 noise tests
 $R_S = 47 \Omega$, $C_S = 0.01 \mu F$

Figure 9. Triac Driver Circuit for Extremely Noisy Environments

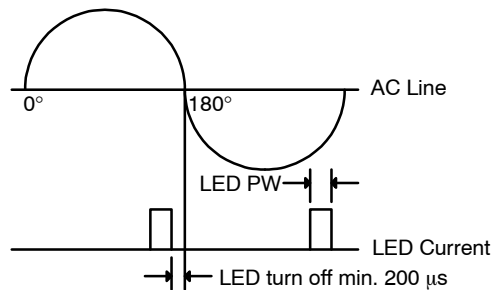

Figure 10. Minimum Time for LED Turn Off to Zero Crossing

REFLOW PROFILE

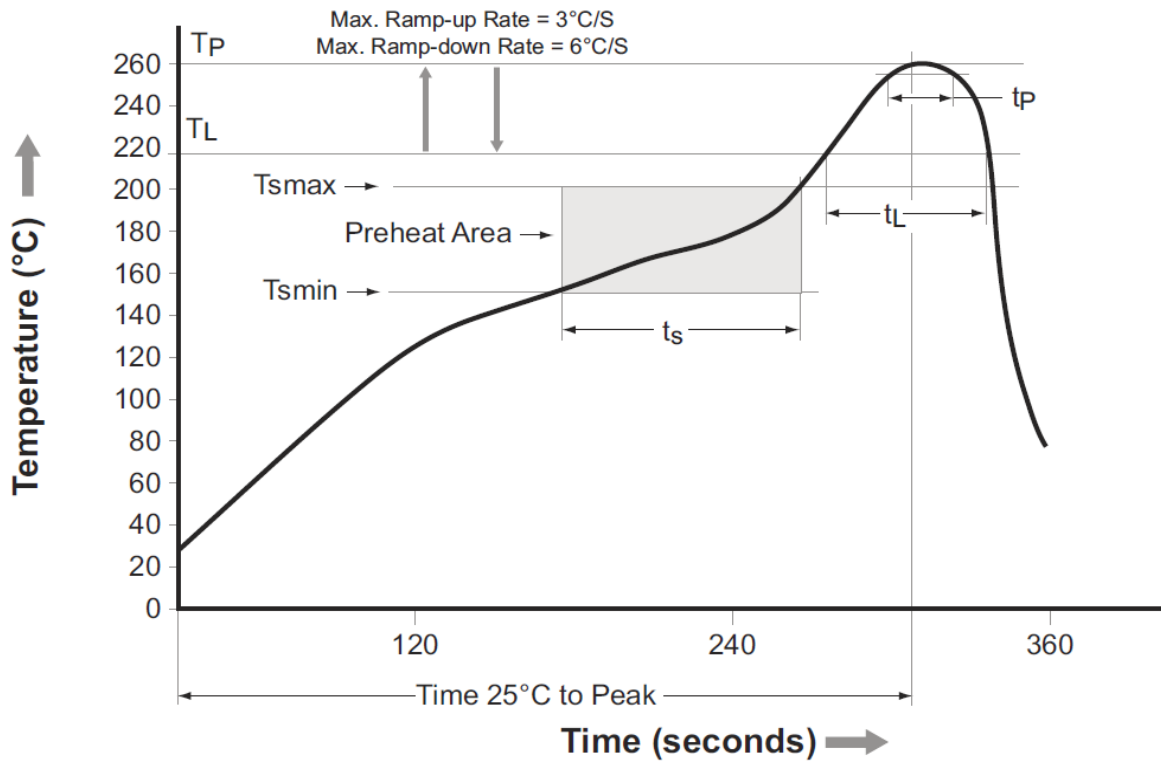

Figure 11. Reflow Profile

Profile Feature	Pb-Free Assembly Profile
Temperature Minimum (Tsmín)	150°C
Temperature Maximum (Tsmáx)	200°C
Time (ts) from (Tsmín to Tsmáx)	60 seconds to 120 seconds
Ramp-up Rate (TL to TP)	3°C/second maximum
Liquidous Temperature (TL)	217°C
Time (tl) Maintained Above (TL)	60 seconds to 150 seconds
Peak Body Package Temperature	260°C +0°C / -5°C
Time (tp) within 5°C of 260°C	30 seconds
Ramp-down Rate (TP to TL)	6°C/second maximum
Time 25°C to Peak Temperature	8 minutes maximum

MOC3051M, MOC3052M, MOC3053M

ORDERING INFORMATION (Note 4)

Device	Package	Shipping
MOC3051M	DIP 6-Pin	Tube (50 Units)
MOC3051SM	SMT 6-Pin (Lead Bend)	Tube (50 Units)
MOC3051SR2M	SMT 6-Pin (Lead Bend)	Tape and Reel (1000 Units)
MOC3051VM	DIP 6-Pin, DIN EN/IEC60747-5-5 Option	Tube (50 Units)
MOC3051SVM	SMT 6-Pin (Lead Bend), DIN EN/IEC60747-5-5 Option	Tube (50 Units)
MOC3051SR2VM	SMT 6-Pin (Lead Bend), DIN EN/IEC60747-5-5 Option	Tape and Reel (1000 Units)
MOC3051TVM	DIP 6-Pin, 0.4" Lead Spacing, DIN EN/IEC60747-5-5 Option	Tube (50 Units)

4. The product orderable part number system listed in this table also applies to the MOC3052M and MOC3053M product families.

MECHANICAL CASE OUTLINE

PACKAGE DIMENSIONS

ON Semiconductor®



PDIP6 8.51x6.35, 2.54P
CASE 646BX
ISSUE O

DATE 31 JUL 2016



NOTES:

- A) NO STANDARD APPLIES TO THIS PACKAGE.
- B) ALL DIMENSIONS ARE IN MILLIMETERS.
- C) DIMENSIONS ARE EXCLUSIVE OF BURRS, MOLD FLASH, AND TIE BAR EXTRUSION

DOCUMENT NUMBER:	98AON13449G	Electronic versions are uncontrolled except when accessed directly from the Document Repository. Printed versions are uncontrolled except when stamped "CONTROLLED COPY" in red.
DESCRIPTION:	PDIP6 8.51X6.35, 2.54P	PAGE 1 OF 1

ON Semiconductor and are trademarks of Semiconductor Components Industries, LLC dba ON Semiconductor or its subsidiaries in the United States and/or other countries. ON Semiconductor reserves the right to make changes without further notice to any products herein. ON Semiconductor makes no warranty, representation or guarantee regarding the suitability of its products for any particular purpose, nor does ON Semiconductor assume any liability arising out of the application or use of any product or circuit, and specifically disclaims any and all liability, including without limitation special, consequential or incidental damages. ON Semiconductor does not convey any license under its patent rights nor the rights of others.

MECHANICAL CASE OUTLINE

PACKAGE DIMENSIONS

ON Semiconductor®



PDIP6 8.51x6.35, 2.54P

CASE 646BY

ISSUE A

DATE 15 JUL 2019



NOTES:

1. DIMENSIONING AND TOLERANCING PER ASME Y14.5M, 2009.
2. CONTROLLING DIMENSION: MILLIMETERS
3. DIMENSIONS A, A1, AND L ARE MEASURED WITH THE PACKAGE SEATED.
4. DIMENSIONS D, D1, AND E1 DO NOT INCLUDE MOLD FLASH OR PROTRUSIONS. MOLD FLASH OR PROTRUSIONS ARE NOT TO EXCEED 2.54mm.
5. PACKAGE CONTOUR IS OPTIONAL (ROUNDED OR SQUARE CORNERS).
6. CENTER LINE OF CORNER LEADS ARE LOCATED BY LOCATING THE CENTER OF FEATURE b2 AND b3.

DIM	MILLIMETERS		
	MIN.	NOM.	MAX.
A	---	---	4.80
A1	0.38	---	---
A2	3.28	3.40	3.53
A3	2.49 REF		
A4	1.89 REF		
b	0.41	0.46	0.51
b1	0.76	0.92	1.14
b2	0.25	0.28	0.36
b3	1.02	1.40	1.78
b4	1.778 REF		
c	0.20	0.25	0.30
D	8.13	8.51	8.89
D1	0.86 REF		
E	6.10	6.35	6.60
E1	8.43	9.17	9.90
E2	8.13 REF		
e	2.54 BSC		
L	0.16	0.52	0.88

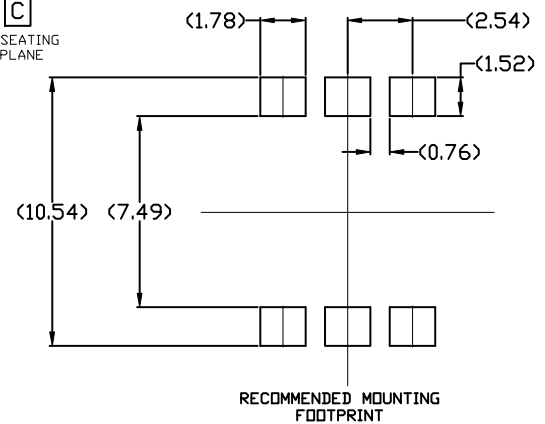
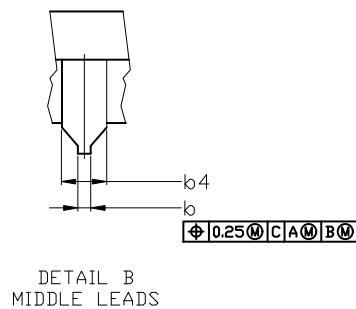
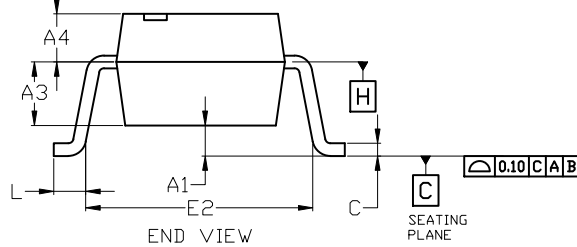

For additional information on our Pb-Free strategy and soldering details, please download the ON Semiconductor Soldering and Mounting Techniques Reference Manual, SOLDERM/D.

DOCUMENT NUMBER:	98AON13450G	Electronic versions are uncontrolled except when accessed directly from the Document Repository. Printed versions are uncontrolled except when stamped "CONTROLLED COPY" in red.
DESCRIPTION:	PDIP6 8.51x6.35, 2.54P	PAGE 1 OF 1

ON Semiconductor and are trademarks of Semiconductor Components Industries, LLC dba ON Semiconductor or its subsidiaries in the United States and/or other countries. ON Semiconductor reserves the right to make changes without further notice to any products herein. ON Semiconductor makes no warranty, representation or guarantee regarding the suitability of its products for any particular purpose, nor does ON Semiconductor assume any liability arising out of the application or use of any product or circuit, and specifically disclaims any and all liability, including without limitation special, consequential or incidental damages. ON Semiconductor does not convey any license under its patent rights nor the rights of others.

MECHANICAL CASE OUTLINE
PACKAGE DIMENSIONS

PDIP6 8.51x6.35, 2.54P
CASE 646BZ
ISSUE O

DATE 31 JUL 2016

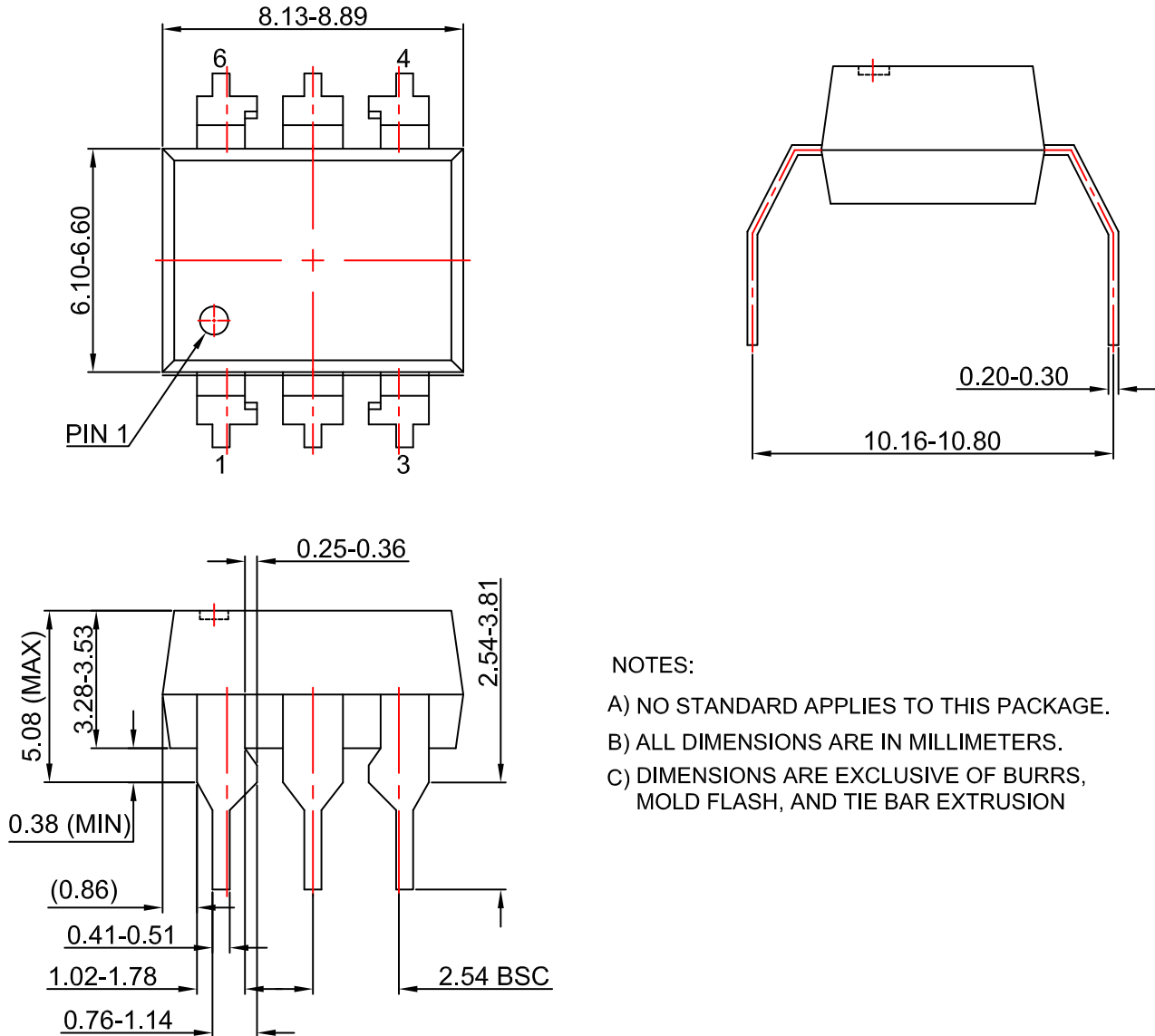

NOTES:

- A) NO STANDARD APPLIES TO THIS PACKAGE.
- B) ALL DIMENSIONS ARE IN MILLIMETERS.
- C) DIMENSIONS ARE EXCLUSIVE OF BURRS, MOLD FLASH, AND TIE BAR EXTRUSION

DOCUMENT NUMBER:	98AON13451G	Electronic versions are uncontrolled except when accessed directly from the Document Repository. Printed versions are uncontrolled except when stamped "CONTROLLED COPY" in red.
DESCRIPTION:	PDIP6 8.51X6.35, 2.54P	PAGE 1 OF 1

ON Semiconductor and  are trademarks of Semiconductor Components Industries, LLC dba ON Semiconductor or its subsidiaries in the United States and/or other countries. ON Semiconductor reserves the right to make changes without further notice to any products herein. ON Semiconductor makes no warranty, representation or guarantee regarding the suitability of its products for any particular purpose, nor does ON Semiconductor assume any liability arising out of the application or use of any product or circuit, and specifically disclaims any and all liability, including without limitation special, consequential or incidental damages. ON Semiconductor does not convey any license under its patent rights nor the rights of others.

onsemi, **Onsemi**, and other names, marks, and brands are registered and/or common law trademarks of Semiconductor Components Industries, LLC dba "**onsemi**" or its affiliates and/or subsidiaries in the United States and/or other countries. **onsemi** owns the rights to a number of patents, trademarks, copyrights, trade secrets, and other intellectual property. A listing of **onsemi**'s product/patent coverage may be accessed at www.onsemi.com/site/pdf/Patent-Marking.pdf. **onsemi** reserves the right to make changes at any time to any products or information herein, without notice. The information herein is provided "as-is" and **onsemi** makes no warranty, representation or guarantee regarding the accuracy of the information, product features, availability, functionality, or suitability of its products for any particular purpose, nor does **onsemi** assume any liability arising out of the application or use of any product or circuit, and specifically disclaims any and all liability, including without limitation special, consequential or incidental damages. Buyer is responsible for its products and applications using **onsemi** products, including compliance with all laws, regulations and safety requirements or standards, regardless of any support or applications information provided by **onsemi**. "Typical" parameters which may be provided in **onsemi** data sheets and/or specifications can and do vary in different applications and actual performance may vary over time. All operating parameters, including "Typicals" must be validated for each customer application by customer's technical experts. **onsemi** does not convey any license under any of its intellectual property rights nor the rights of others. **onsemi** products are not designed, intended, or authorized for use as a critical component in life support systems or any FDA Class 3 medical devices or medical devices with a same or similar classification in a foreign jurisdiction or any devices intended for implantation in the human body. Should Buyer purchase or use **onsemi** products for any such unintended or unauthorized application, Buyer shall indemnify and hold **onsemi** and its officers, employees, subsidiaries, affiliates, and distributors harmless against all claims, costs, damages, and expenses, and reasonable attorney fees arising out of, directly or indirectly, any claim of personal injury or death associated with such unintended or unauthorized use, even if such claim alleges that **onsemi** was negligent regarding the design or manufacture of the part. **onsemi** is an Equal Opportunity/Affirmative Action Employer. This literature is subject to all applicable copyright laws and is not for resale in any manner.

ADDITIONAL INFORMATION

TECHNICAL PUBLICATIONS:

Technical Library: www.onsemi.com/design/resources/technical-documentation
onsemi Website: www.onsemi.com

ONLINE SUPPORT: www.onsemi.com/support

For additional information, please contact your local Sales Representative at www.onsemi.com/support/sales

