

## Product Datasheet

### MFA2P10-A007-C

#### Mellanox® Compatible 25Gb/s SFP28 Active Optical Cable, Active, 7m

##### FEATURES

- Electrical interface compliant to SFF-8431
- 850nm VCSEL laser and PIN photo-detector
- Low power consumption of max 3.5W
- Maximum link length of 70m on OM3 MMF and 100m on OM4 MMF
- Digital diagnostics functions are available via the I2C interface
- Hot pluggable electrical interface
- RoHS compliant
- 0 to 70°C case temperature operating range

##### APPLICATIONS

- 25GBASE-SR Ethernet
- InfiniBand QDR, SDR, DDR
- Servers, switches, storage and host card adapters

##### DESCRIPTION

ATGBICS MFA2P10-A007 is a Single-Channel, Pluggable, Fiber-Optic SFP28 for 25 Gigabit Ethernet and Infiniband EDR Applications. It is a high-performance module for short-range data communication and interconnect applications which operate at 25.78125 Gbps up to 70 m using OM3 fiber or 100 m using OM4 fiber. This module is designed to operate over multimode fiber systems using a nominal wavelength of 850nm. The electrical interface uses a 20 contact edge type connector.

## Product Datasheet

### Absolute Maximum Ratings

Parameter	Symbol	Min	Max	Unit
Storage Temperature	TST	-20	85	°C
Relative Humidity	RH	0	85	%
Case Operating Temperature	TOPC	0	70	°C
Supply Voltage	VCC	-0.3	3.6	V

### Recommended Operating Conditions

Parameter	Symbol	Min	Typical	Max	Unit
Operating Case temperature	TA	0		+70	°C
Supply Voltage	VCC	3.13	3.3	3.47	V
Supply current	I <sub>cc</sub>			300	mA
Channel Data Rate	Dr		25.78125		Gbps

### Transmitter

**Measured condition:** Channel Data Rate 25.78125Gbps, V<sub>CC</sub>R=3.3V, PRBS31, Case Operating Temperature 0~70°C

Parameter	Symbol	Min	Typical	Max	Unit
Input differential impedance	Z <sub>in</sub>	90	100	110	Ω
Differential Data Input Swing	V <sub>in</sub> PP	300		1100	mV
Transmit Enable Voltage	V <sub>EN</sub>			0.8	V
Transmit Disable Voltage	V <sub>D</sub>	2.0			V
Average launch power	PAVG	-7.5	-1	+2.5	dBm
Extinction Ratio	ER	2.0			dB
Centre Wavelength	λ <sub>c</sub>	840	850	860	nm

## Product Datasheet

### Receiver

Measured condition: Channel Data Rate 25.78125Gbps, VR<sub>CC</sub>R=3.3V, PRBS31, Case Operating Temperature 0~70°C

Parameter	Symbol	Min	Typical	Max	Unit
Center Wavelength	$\lambda_c$	840	850	860	nm
Differential Data Output Swing	V <sub>out</sub> PP	500		800	mV
Bit Error Rate	BER			E-12	
Receiver Overload	PinMAX	2.5			dBm
Output Differential Impedance	Z <sub>out</sub>	90	100	110	ohm
LOS Fault	V <sub>OH</sub>	2.4			V
LOS Normal	V <sub>OL</sub>			0.4	V

## Product Datasheet

### Pin Descriptions

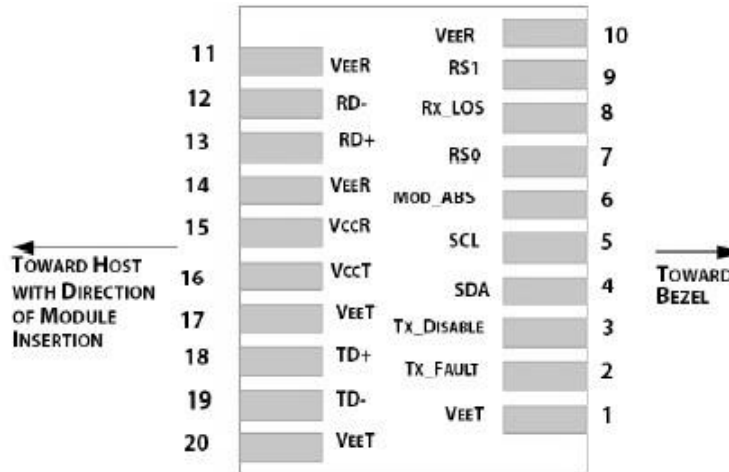

PIN	Name	Function/Description
1	VeeT	Transmitter Ground
2	Tx_Fault	Transmitter Fault - High indicates a fault condition
3	Tx_Disable	Transmitter Disable - High or open disables the transmitter
4	SDA	Two wire serial interface Data Line
5	SCL	Two wire serial interface Clock Line
6	MOD_ABS	Module Absent (Output), connected to VeeT or VeeR in the module
7	RS0	Rx Rate Select, not used
9	RS1	Tx Rate Select, not used
10	VeeR	Receiver Ground
11	VeeR	Receiver Ground
12	RD-	Receiver Inverted DATA out
13	RD+	Receiver Non-inverted DATA out
14	VeeR	Receiver Ground
15	VccR	Receiver Power Supply
16	VccT	Transmitter Power Supply
17	VeeT	Transmitter Ground
18	TD+	Transmitter Non-Inverted DATA in
19	TD-	Transmitter Inverted DATA in
20	VeeT	Transmitter Ground

## Product Datasheet

### Module Power Supply Tolerance Filtering

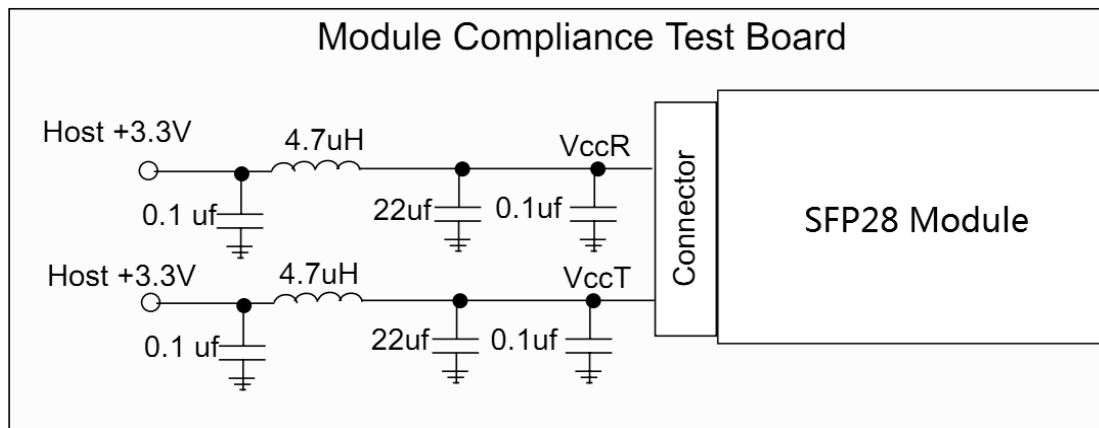

### Mechanical Design Diagram

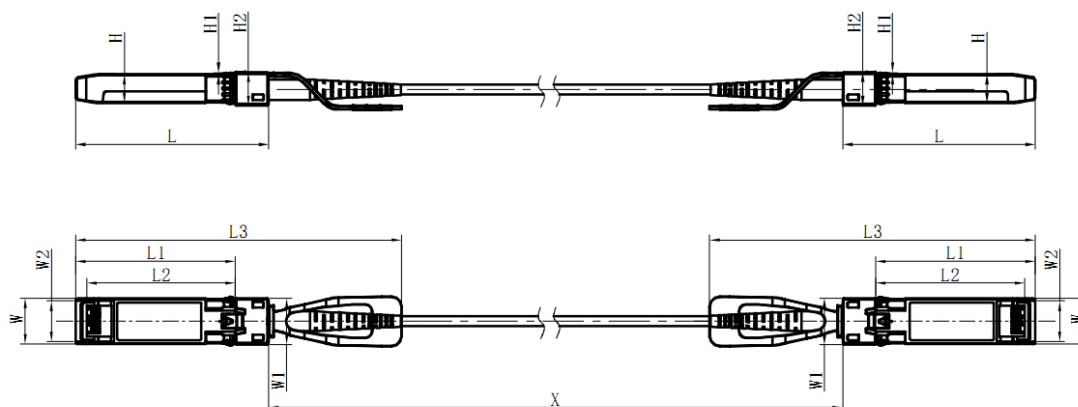

Unit: mm

	L	L1	L2	L3	W	W1	W2	H	H1	H2
MAX	57.75	48.0	44.65	102.5	13.75	14.0	12.25	8.65	0.55	10.4
Typical	57.55	47.8	44.45	101.5	13.65	13.9	12.15	8.55	0.5	10.2
MIN	57.35	47.6	44.25	100.5	13.55	13.8	12.05	8.45	0.45	10.0

Length	Note
<b>3m</b>	OM3 Round Cable
<b>5m</b>	OM3 Round Cable
<b>10m</b>	OM3 Round Cable
<b>20m</b>	OM3 Round Cable
<b>30m</b>	OM3 Round Cable
<b>50m</b>	OM3 Round Cable
<b>70m</b>	OM3 Round Cable
<b>100m</b>	OM4 Round Cable

## Product Datasheet