

Product Datasheet

AOC-Q-Q-100G-1M-C

Arista® Compatible 100GBASE-SR4 QSFP28 to QSFP28 Active Optical Cable, Active, 1m

FEATURES

- Compliant with 100GBASE-SR4 and CAUI-4 specification per IEEE 802.3bm
- Compliant to SFF-8665 (QSFP28 Solution) Revision 1.8
- Supports 100 Gbps data rate links up to 70m/100 m via OM3/OM4, respectively.
- VCSEL array transmitter and PIN array receiver
- Low power consumption of max 3.5W
- Hot pluggable electrical interface
- Using standard 12/8 lane optical fiber with 3-mm round cable
- 0 to 70°C case temperature operating range
- RoHS-6 Compliant (lead-free)

APPLICATIONS

- Ethernet for 100GBASE-SR4
- InfiniBand EDR, FDR, & QDR
- HPC Interconnects
- Proprietary Interconnections

DESCRIPTION

ATGBICS AOC-Q-Q-100G-1M-C QSFP28 active optical cables are high-performance active optical cable with bi-directional signal transmission and aggregate 100-Gbps bandwidth for both InfiniBand EDR and Ethernet 100G-SR4 applications. Compared to conventional copper cables, longer and lighter optical cables enable the ease of complicated data-center cabling. The AOCs utilize multimode fiber with 850-nm VCSELs and PIN PDs. The certificated cables have superior signal integrity and bit- error-rate, which enables reliable operation performance.

Product Datasheet

Absolute Maximum Ratings

Not necessarily applied together. Exceeding these values may cause permanent damage. Functional operation under these conditions is not implied.

Parameter	Min	Max	Unit	Note
Storage Temperature	0	70	°C	1
3.3V Power Supply Voltage	-0.5	3.6	V	
Data Input Voltage-Single Ended	-0.5		V _{cc} +0.5	
Control Input Voltage	-0.5	3.6	V	
Relative Humidity	5	85	%	2

Note:

1. Limited by the fiber cable jacket, not the active ends
2. Non-condensing

Recommended Operating Conditions

Parameter	Min	Typical	Max	Unit	Note
Case Operating Temperature	0		70	°C	
Power Supply Voltage	3.135	3.3	3.465	V	
Data Rate per Channel			25.78125	Gbps	
Bit Error Ratio (BER)		10-12			1, 2
Control Input Voltage High	2		V _{cc} +0.3	V	
Control Input Voltage Low	-0.3		0.8	V	
Two Wire Serial (TWS) Interface Clock Rate			400	kHz	
Differential Data Input / Output Load		100		Ohms	+/- 10%
Standard Cable Lengths			100	m	3

Note:

1. Bit-Error-Rate (BER) is tested with PRBS 2³¹-1 pattern
2. 100G QSFP28 AOC cable requires an electrical connector compliant with SFF-8662 or SFF-8672 which is used on the host board in order to guarantee its electrical interface specification.
3. Per 100GBASE-SR4 Standard, cable length supports up to 70m / 100m via OM3 / OM4, respectively. Different cable length within this range upon customization.

Product Datasheet

Functional Description of Transceiver

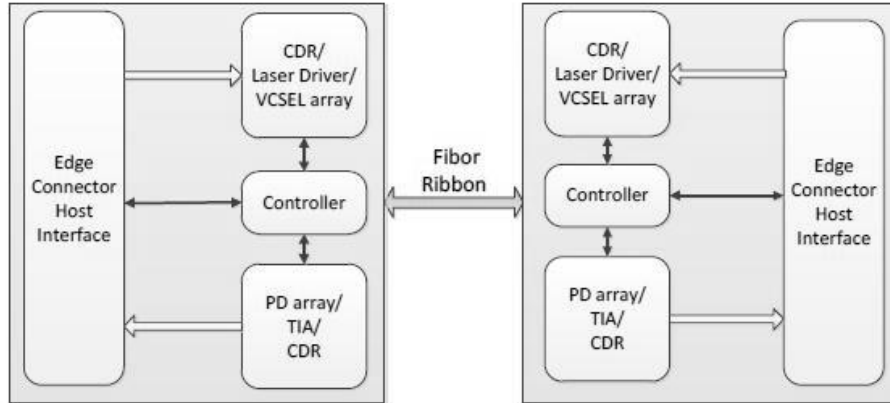

Product Datasheet

Electrical Specifications

Parameter	Symbol	Min	Typical	Max	Unit	Note
Transceiver Electrical Characteristics						
TRx Power Consumption			2.5	3.5	W	
TRx Power-on Initialization Time				2000	ms	
CAUI-4 Module Electrical Input Characteristics (TP1)						
Single Ended Input Voltage Tolerance		-0.4		3.3	V	
Differential pk-pk input voltage tolerance		900			mV	
Differential Input Return Loss	Sdd11		See Eq. 1		dB	1
Differential to Common-mode Input Return Loss	Sdc11		See Eq. 2		dB	2
DC common mode voltage		-350		2850	mV	

Notes:

$$1. \quad RLd(f) \geq \begin{cases} 9.5 - 0.37f & 0.01 \leq f < 8 \\ 4.75 - 7.4 \log_{10} \left(\frac{f}{14} \right) & 8 \leq f < 19 \end{cases} \text{ (dB)} \quad \text{(Eq.1)}$$

where

f is the frequency in GHz

RLd is the CAUI-4 Chip-to-module input differential return loss

$$2. \quad RLdc(f) \geq \begin{cases} 22 - 20 \left(\frac{f}{25.78} \right) & 0.01 \leq f < 12.89 \\ 15 - 6 \left(\frac{f}{25.78} \right) & 12.89 \leq f < 19 \end{cases} \text{ (dB)} \quad \text{(Eq.2)}$$

where

f is the frequency in GHz

$RLdc$ loss is the CAUI-4 Chip-to-module input differential to common mode input return loss

Product Datasheet

Parameter	Symbol	Min	Typical	Max	Unit	Note
CAUI-4 Module Electrical Output Characteristics (TP4)						
AC Common-Mode Output Voltage (RMS)				17.5	mV	
Differential Output Voltage				900	mV	
Eye Width		0.57			UI	
Eye Height, Differential		228			mV	
Vertical Eye Closure				5.5	dB	
Differential Output Return Loss	Sdd22	See Eq. 1			dB	1
Common to Differential Mode Conversion Return Loss	Scd22	See Eq. 2			dB	2
Transition Time (20% to 80%)		12			ps	
DC Common Voltage		-350		2850	mV	

Notes:

$$1. \quad RLd(f) \geq \begin{cases} 9.5 - 0.37f & 0.01 \leq f < 8 \\ 4.75 - 7.4 \log_{10} \left(\frac{f}{14} \right) & 8 \leq f < 19 \end{cases} \quad (\text{dB}) \quad (\text{Eq.1})$$

where

f is the frequency in GHz

RLd is the CAUI-4 Chip-to-module host output differential return loss

$$2. \quad RLdc(f) \geq \begin{cases} 22 - 20 \left(\frac{f}{25.78} \right) & 0.01 \leq f < 12.89 \\ 15 - 6 \left(\frac{f}{25.78} \right) & 12.89 \leq f < 19 \end{cases} \quad (\text{dB}) \quad (\text{Eq.2})$$

where

f is the frequency in GHz

$RLdc$ is the CAUI-4 Chip-to-module output common to differential mode conversion return loss

Optical Cable Specification

Parameter	Specification	Notes
Minimum Cable Bending Radius	~30 mm	
Cable Cross-Section Dimension	Round Cable with 3 mm in Diameter	
Cable Cover Type	LSZH	1
Standard Cable Length	10, 20, 30, 50, 70, 100-m	2
Cable Length Tolerance	+100/-0 cm	

Notes:

1. Cable cover type standard is LSZH. Other types can be available upon request.
2. Different cable length within this range upon customization.

Product Datasheet

QSFP28 Module Pad Assignments and Descriptions

Pin	Logic	Symbol	Description	Plug Sequence
1		GND	Ground	1
2	CML-I	Tx2n	Transmitter Inverted Data Input	3
3	CML-I	Tx2p	Transmitter Non-Inverted Data Input	3
4		GND	Ground	1
5	CML-I	Tx4n	Transmitter Inverted Data Input	3
6	CML-I	Tx4p	Transmitter Non-Inverted Data Input	3
7		GND	Ground	1
8	LVTTL-I	ModSelL	Module Select	3
9	LVTTL-I	ResetL	Module Reset	3
10		Vcc Rx	+3.3V Power Supply Receiver	2
11	LVCMOS-I/O	SCL	2-wire serial interface clock	3
12	LVCMOS-I/O	SDA	2-wire serial interface data	3
13		GND	Ground	1
14	CML-O	Rx3p	Receiver Non-Inverted Data Output	3
15	CML-O	Rx3n	Receiver Inverted Data Output	3
16		GND	Ground	1
17	CML-O	Rx1p	Receiver Non-Inverted Data Output	3
18	CML-O	Rx1n	Receiver Inverted Data Output	3
19		GND	Ground	1
20		GND	Ground	1
21	CML-O	Rx2n	Receiver Inverted Data Output	3
22	CML-O	Rx2p	Receiver Non-Inverted Data Output	3
23		GND	Ground	1
24	CML-O	Rx4n	Receiver Inverted Data Output	3
25	CML-O	Rx4p	Receiver Non-Inverted Data Output	3
26		GND	Ground	1
27	LVTTL-O	ModPrsL	Module Present	3
28	LVTTL-O	IntL	Interrupt	3
29		Vcc Tx	+3.3V Power supply transmitter	2
30		Vcc1	+3.3V Power supply	2
31	LVTTL-I	LPMODE	Low Power Mode	3
32		GND	Ground	1
33	CML-I	Tx3p	Transmitter Non-Inverted Data Input	3
34	CML-I	Tx3n	Transmitter Inverted Data Input	3
35		GND	Ground	1
36	CML-I	Tx1p	Transmitter Non-Inverted Data Input	3
37	CML-I	Tx1n	Transmitter Inverted Data Input	3
38		GND	Ground	1

Product Datasheet

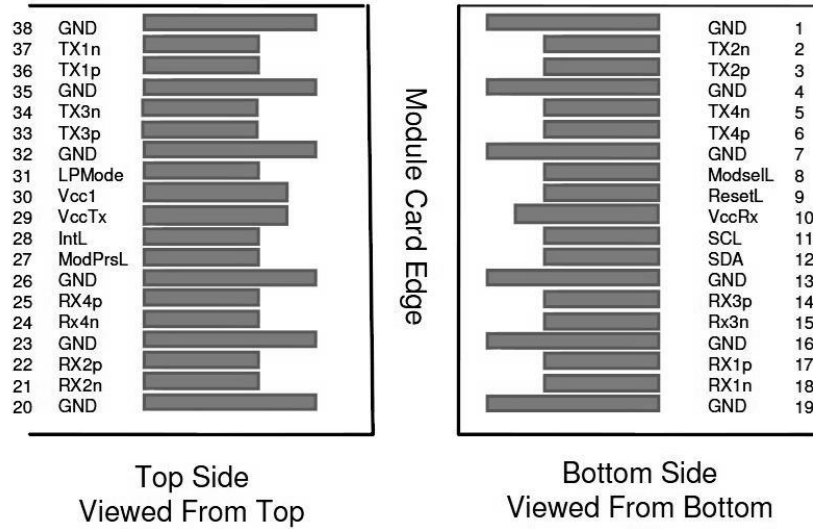

RECOMMENDED HOST BOARD POWER SUPPLY CIRCUIT

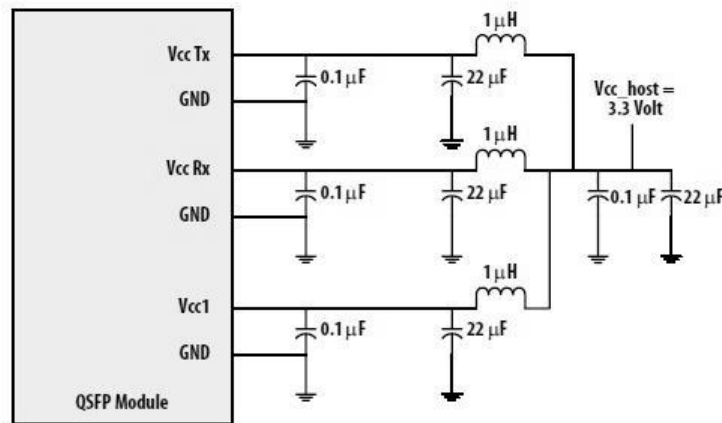

RECOMMENDED INTERFACE CIRCUIT

Product Datasheet

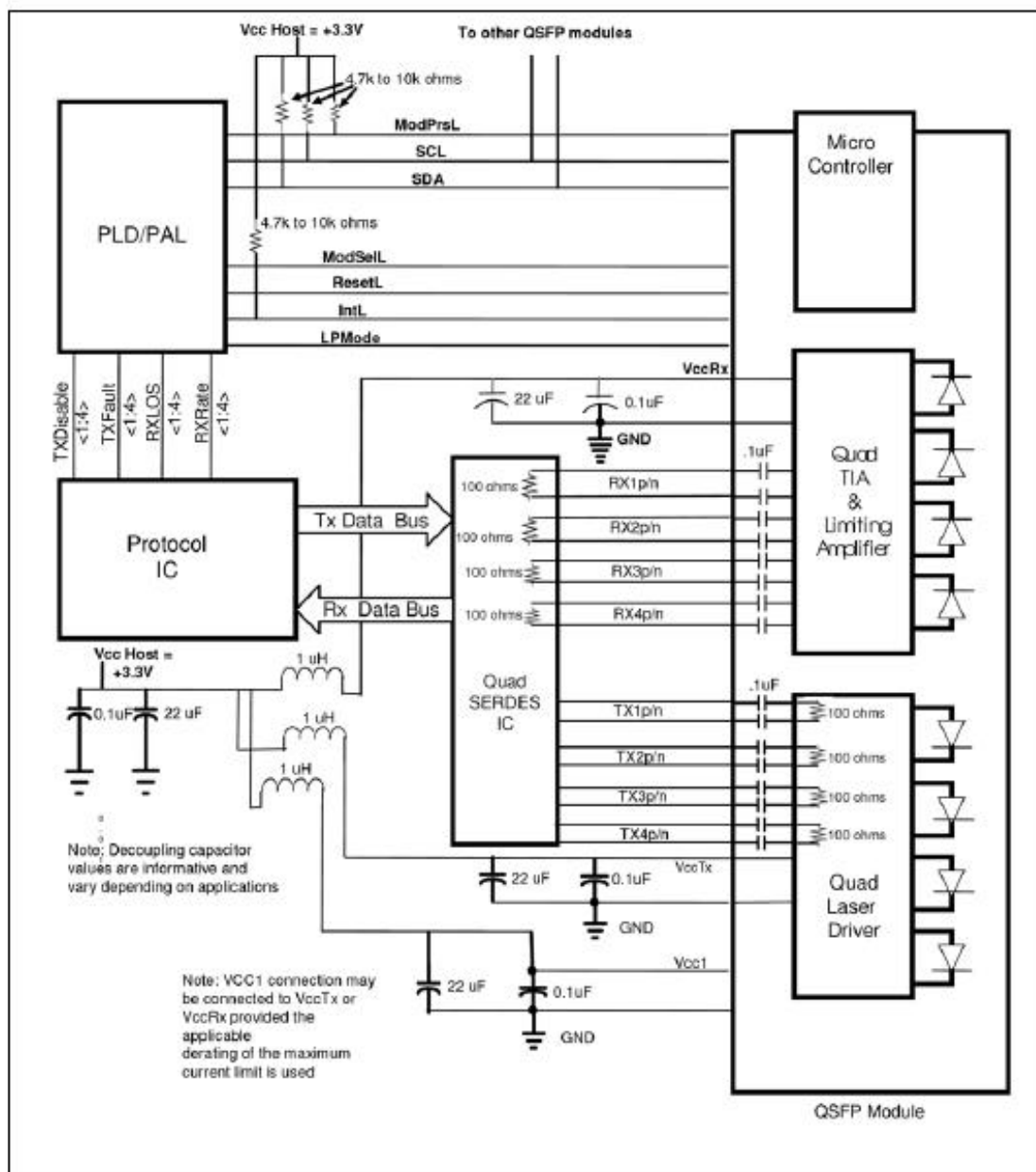

Product Datasheet

Memory Map

The memory map is structured as a single address and multiple page approaches, according to the QSFP28 SFF-8636 MSA specification as shown in the below. For a more detailed description of this memory map or lower pages, please see our memory map document with flexible customization settings.

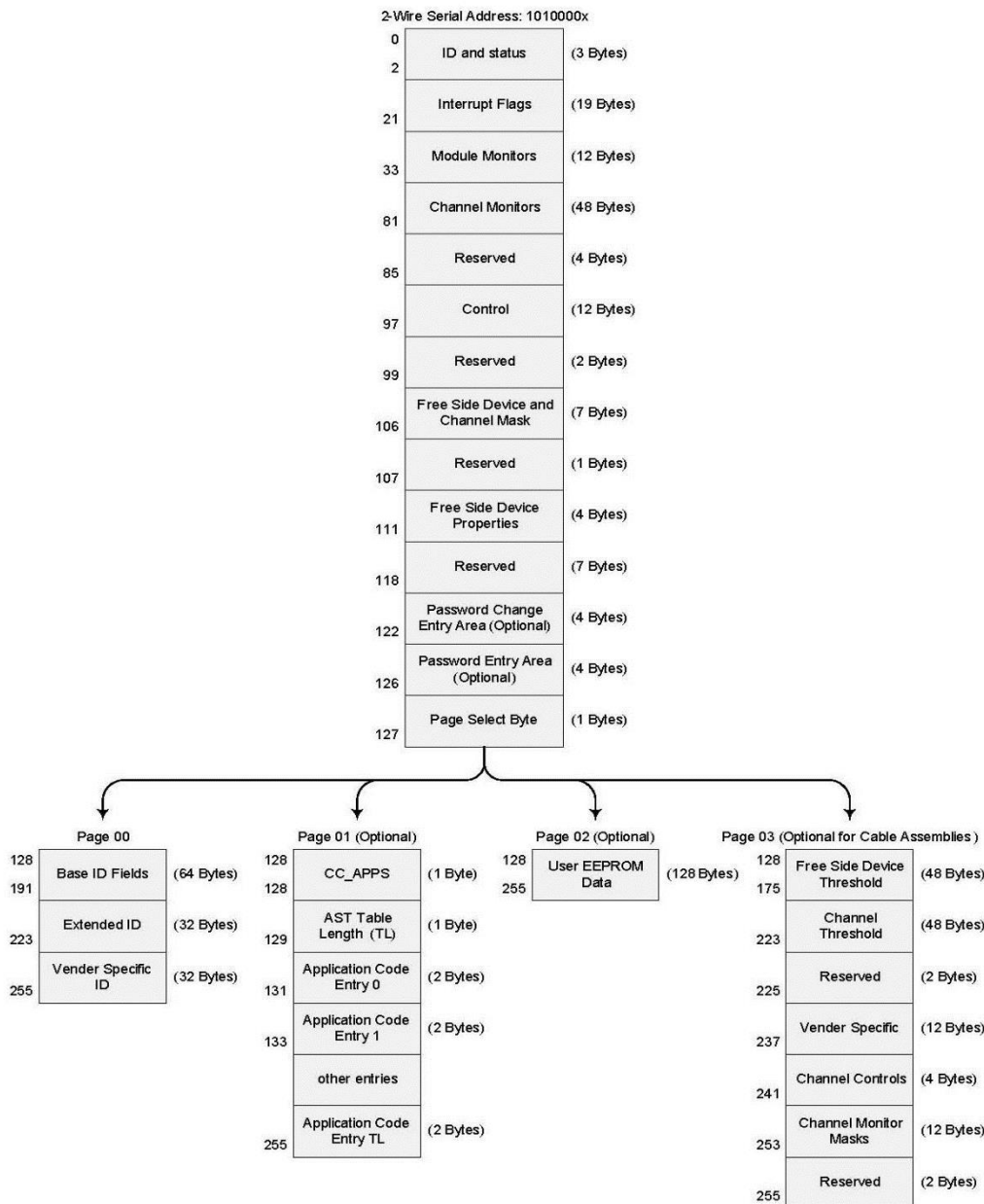

Product Datasheet

MECHANICAL DIMENSIONS



Ordering Information

Length	Note
3m	OM3 Round Cable
5m	OM3 Round Cable
10m	OM3 Round Cable
20m	OM3 Round Cable
30m	OM3 Round Cable
50m	OM3 Round Cable
70m	OM3 Round Cable
100m	OM4 Round Cable