

Product Datasheet

MC2309124-004-C

Mellanox® Compatible 40Gb/s QSFP+ to 10Gb/s SFP+ Direct Attach Cable, Copper, 4m, Passive

FEATURES

- Compliant with SFF- 8436, SFF-8431, SFF-8432 and SFF-8472
- Up to 10.3125Gb/s data rate per channel
- Up to 7m transmission
- Temperature Range: 0 ~ 70 °C
- Single 3.3V power supply
- RoHS compliant

BENEFITS

- Cost-effective copper solution
- Low total system power solution
- Low total system EMI solution
- Optimized design for signal integrity

DESCRIPTION

ATGBICS® MC2309124-004-C 40G QSFP+ to 1 x 10G SFP+ Direct Attach Cable is compliant with the SFF-8436, SFF-8431, SFF-8432 and SFF-8472 specifications. This cable is available in lengths of 1m to 7m, wire gauge is dependent on cable length.

General Product Characteristics

QSFP/SFP+ DAC Specifications	
Number of Lanes	Tx & Rx
Channel Data Rate	10.3125 Gbps
Operating Temperature	0 to + 70°C
Storage Temperature	-40 to + 85°C
Supply Voltage	3.3 V nominal
Electrical Interface	38 pins edge connector (QSFP+) 20 pins edge connector (SFP+)
Management Interface	2 Serial, I C

Product Datasheet

High Speed Characteristics

Parameter	Symbol	Min	Typical	Max	Unit	Note
Differential Impedance	TDR	90	100	110	Ω	
Insertion loss	SDD21	-17.04			dB	At 5.15625 GHz
Differential Return Loss	SDD11			See 1	dB	At 0.05 to 4.1 GHz
	SDD22			See 2	dB	At 4.1 to 11.1 GHz
Differential to common-mode return loss	SCD11					
	SCD22			-10	dB	At 0.2 to 11.1 GHz
Common-mode to common-mode output return loss	SCC11	-3				
	SCC22				dB	At 0.01 to 11.1 GHz

Notes:

1. Reflection Coefficient given by equation $SDD11(\text{dB}) < -12 + 2 \times \text{SQRT}(f)$, with f in GHz
2. Reflection Coefficient given by equation $SDD11(\text{dB}) < -6.3 + 13 \times \log_{10}(f/5.5)$, with f in GHz

Product Datasheet

QSFP+ Pin Function Definition

Pin	Logic	Symbol	Description
1		GND	Ground
2	CML-I	Tx2n	Transmitter Inverted Data Input
3	CML-I	Tx2p	Transmitter Non-Inverted Data Input
4		GND	Ground
5	CML-I	Tx4n	Transmitter Inverted Data Input
6	CML-I	Tx4p	Transmitter Non-Inverted Data Input
7		GND	Ground
8	LVTTL-I	ModSelL	Module Select
9	LVTTL-I	ResetL	Module Reset
10		Vcc Rx	+3.3V Power Supply Receiver
11	LVC MOS-I/O	SCL	2-wire serial interface clock
12	LVC MOS-I/O	SDA	2-wire serial interface data
13		GND	Ground
14	CML-O	Rx3p	Receiver Non-Inverted Data Output
15	CML-O	Rx3n	Receiver Inverted Data Output
16		GND	Ground
17	CML-O	Rx1p	Receiver Non-Inverted Data Output
18	CML-O	Rx1n	Receiver Inverted Data Output
19		GND	Ground
20		GND	Ground
21	CML-O	Rx2n	Receiver Inverted Data Output
22	CML-O	Rx2p	Receiver Non-Inverted Data Output

Product Datasheet

23		GND	Ground
24	CML-O	Rx4n	Receiver Inverted Data Output
25	CML-O	Rx4p	Receiver Non-Inverted Data Output
26		GND	Ground
27	LVTTL-O	ModPrsL	Module Present
28	LVTTL-O	IntL	Interrupt
29		Vcc Tx	+3.3V Power supply transmitter
30		Vcc1	+3.3V Power supply
31	LVTTL-I	LPMode	Low Power Mode
32		GND	Ground
33	CML-I	Tx3p	Transmitter Non-Inverted Data Input
34	CML-I	Tx3n	Transmitter Inverted Data Input
35		GND	Ground
36	CML-I	Tx1p	Transmitter Non-Inverted Data Input
37	CML-I	Tx1n	Transmitter Inverted Data Input
38		GND	Ground

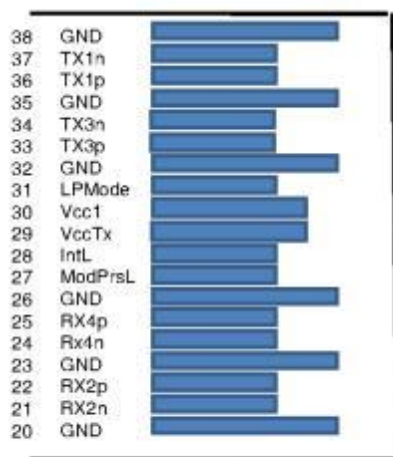

Top Side
Viewed From Top

Module Card Edge

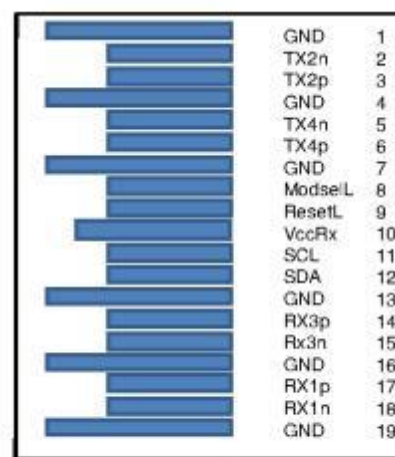

Bottom Side
Viewed From Bottom

Product Datasheet

SFP+ Pin Function Definition

Pin	Logic	Symbol	Description
1		VeeT	Module Transmitter Ground
2	LVTTL-O	Tx_Fault	Module Transmitter Fault
3	LVTTL-I	Tx_Disable	Transmitter disable; Turns off transmitter laser output
4	LVTTL-I/O	SDA	2-wire Serial Interface Data Line (Same as MOD-DEF2 in INF-8074i)
5	LVTTL-I/O	SCL	2-wire Serial Interface Clock (Same as MOD-DEF1 in INF-8074i)
6		Mod_ABS	Module Absent, connected to VeeT or VeeR in the module
7	LVTTL-I	RS0	Rate Select 0, optionally controls SFP+ module receiver
8	LVTTL-O	Rx_LOS	Receiver Loss of Signal Indication (In FC designated as Rx_LOS and in Ethernet designated as Signal Detect)
9	LVTTL-I	RS1	Rate Select 1, optionally controls SFP+ module transmitter
10		VeeR	Module Receiver Ground
11		VeeR	Module Receiver Ground
12	CML-O	RD-	Receiver Inverted Data Output
13	CML-O	RD+	Receiver Non-Inverted Data Output
14		VeeR	Module Receiver Ground
15		VccR	Module Receiver 3.3 V Supply
16		VccT	Module Transmitter 3.3 V Supply
17		VeeT	Module Transmitter Ground
18	CML-I	TD+	Transmitter Non-Inverted Data Input
19	CML-I	TD-	Transmitter Inverted Data Input
20		VeeT	Module Transmitter Ground

Product Datasheet

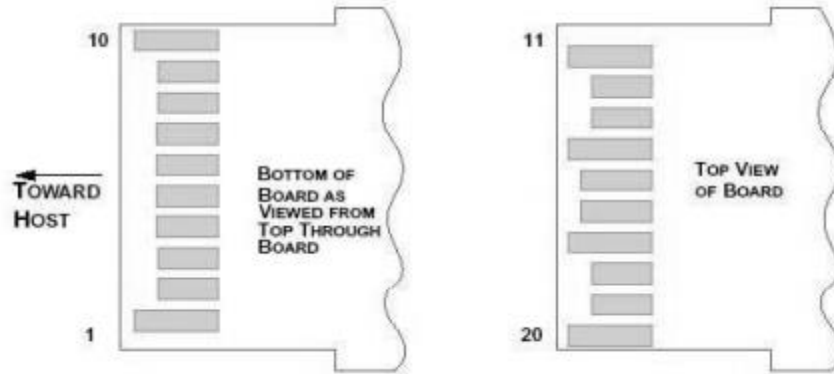

Mechanical Specifications

The connector is compatible with the SFF-8436 and SFF-8432 specification.

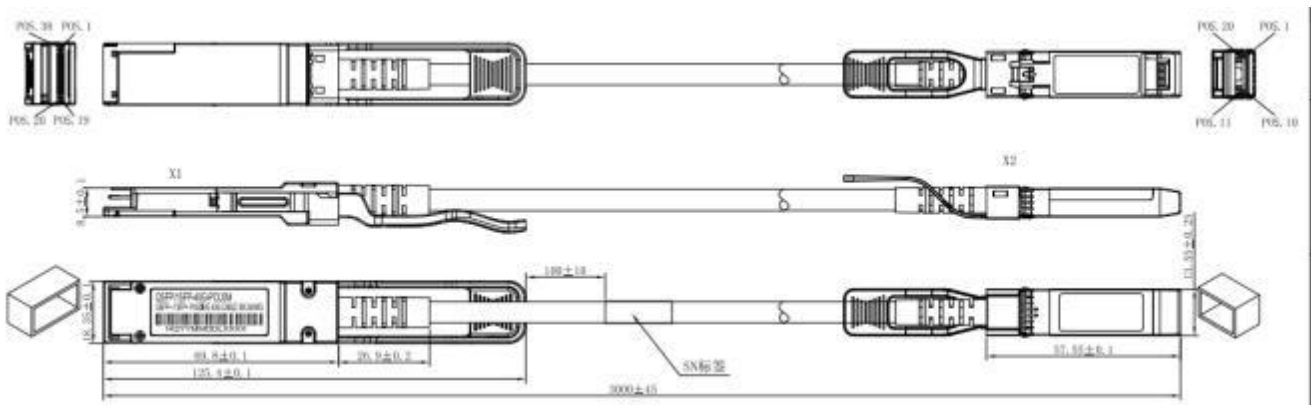

Length (m)	Wire AWG
1	30
2	30
3	30
5	26
7	24

Product Datasheet

Regulatory Compliance

Feature	Test Method	Performance
Electrostatic Discharge (ESD) to the Electrical Pins	MIL-STD-883C Method 3015.7	Class 1(>2000 Volts)
Electromagnetic Interference (EMI)	FCC Class B	Compliant with Standards
	CENELEC EN55022 Class B	
	CISPR22 ITE Class B	
RF Immunity (RFI)	IEC61000-4-3	Typically Show no Measurable Effect from a 10V/m Field Swept from 80 to 1000MHz
RoHS Compliance	RoHS Directive 2011/65/EU and it's Amendment Directives (EU)	RoHS (EU) 2015/863 compliant
REACH Compliance	REACH Regulation (EC) No 1907/2006	REACH (EC) No 1907/2006 compliant