



## Small Signal Schottky Diodes



### FEATURES

- Integrated protection ring against static discharge
- Low capacitance
- Low leakage current
- Low forward voltage drop
- Material categorization: for definitions of compliance please see [www.vishay.com/doc?99912](http://www.vishay.com/doc?99912)



**RoHS**  
COMPLIANT  
HALOGEN  
**FREE**

### LINKS TO ADDITIONAL RESOURCES



### MECHANICAL DATA

**Case:** MicroMELF

**Weight:** approx. 12 mg

**Cathode band color:** black

**Packaging codes/options:**

TR3/10K per 13" reel (8 mm tape), 10K/box

TR/2.5K per 7" reel (8 mm tape), 12.5K/box

### APPLICATIONS

- IHF-detector
- Protection circuit
- Small battery charger
- AC/DC / DC/DC converter for notebooks

### PARTS TABLE

PART	TYPE DIFFERENTIATION	ORDERING CODE	CIRCUIT CONFIGURATION	REMARKS
MCL103A	$V_R = 40\text{ V}$	MCL103A-TR3 or MCL103A-TR	Single	Tape and reel
MCL103B	$V_R = 30\text{ V}$	MCL103B-TR3 or MCL103B-TR	Single	Tape and reel
MCL103C	$V_R = 20\text{ V}$	MCL103C-TR3 or MCL103C-TR	Single	Tape and reel

### ABSOLUTE MAXIMUM RATINGS ( $T_{amb} = 25\text{ }^\circ\text{C}$ , unless otherwise specified)

PARAMETER	TEST CONDITION	PART	SYMBOL	VALUE	UNIT
Reverse voltage		MCL103A	$V_R$	40	V
		MCL103B	$V_R$	30	V
		MCL103C	$V_R$	20	V
Forward continuous current			$I_F$	200	mA
Peak forward surge current	$t_p = 300\text{ }\mu\text{s}$ , square pulse		$I_{FSM}$	15	A
Power dissipation			$P_{tot}$	400	mW

### THERMAL CHARACTERISTICS ( $T_{amb} = 25\text{ }^\circ\text{C}$ , unless otherwise specified)

PARAMETER	TEST CONDITION	SYMBOL	VALUE	UNIT
Thermal resistance junction to ambient air	On PC board 50 mm x 50 mm x 1.6 mm	$R_{thJA}$	250	K/W
Junction temperature		$T_j$	125	$^\circ\text{C}$
Storage temperature range		$T_{stg}$	-65 to +150	$^\circ\text{C}$



ELECTRICAL CHARACTERISTICS (T <sub>amb</sub> = 25 °C, unless otherwise specified)							
PARAMETER	TEST CONDITION	SYMBOL	SYMBOL	MIN.	TYP.	MAX.	UNIT
Reverse breakdown voltage	I <sub>R</sub> = 10 μA	MCL103A	V <sub>(BR)</sub>	40			V
		MCL103B	V <sub>(BR)</sub>	30			V
		MCL103C	V <sub>(BR)</sub>	20			V
Leakage current	V <sub>R</sub> = 30 V	MCL103A	I <sub>R</sub>			5	μA
	V <sub>R</sub> = 20 V	MCL103B	I <sub>R</sub>			5	μA
	V <sub>R</sub> = 10 V	MCL103C	I <sub>R</sub>			5	μA
Forward voltage drop	I <sub>F</sub> = 20 mA		V <sub>F</sub>			370	mV
	I <sub>F</sub> = 200 mA		V <sub>F</sub>			600	mV
Diode capacitance	V <sub>R</sub> = 0 V, f = 1 MHz		C <sub>D</sub>		50		pF
Reverse recovery time	I <sub>F</sub> = I <sub>R</sub> = 50 mA to 200 mA, recovery to 0.1 I <sub>R</sub>		t <sub>rr</sub>		10		ns

**TYPICAL CHARACTERISTICS** (T<sub>amb</sub> = 25 °C, unless otherwise specified)

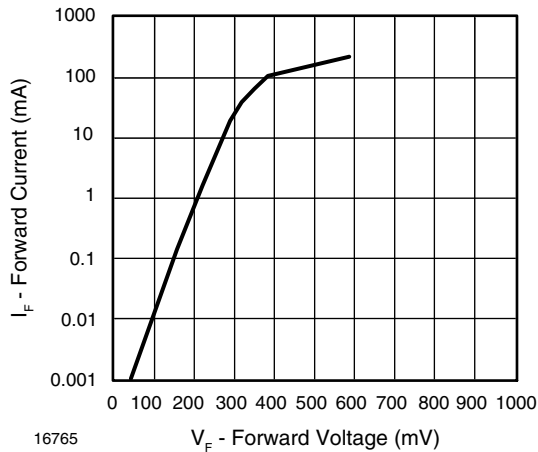

16765 Fig. 1 - Forward Current vs. Forward Voltage

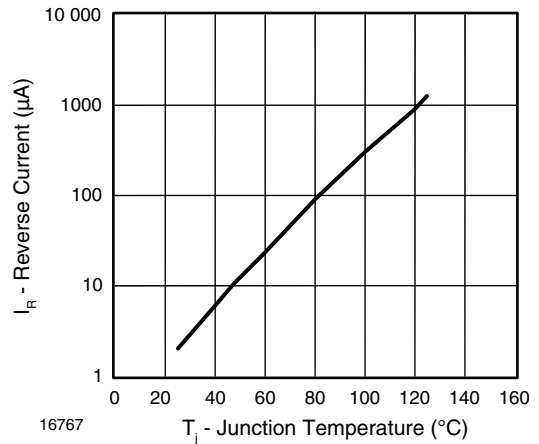

16767 Fig. 3 - Reverse Current vs. Junction Temperature

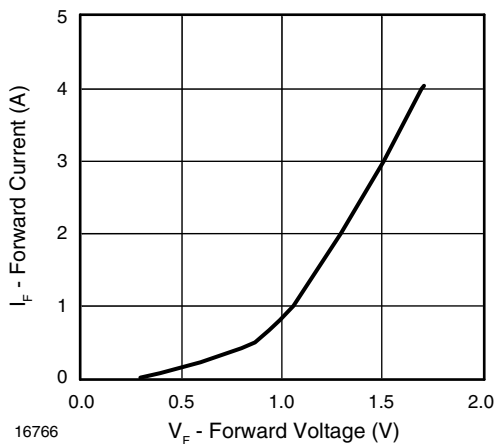

16766 Fig. 2 - Forward Current vs. Forward Voltage

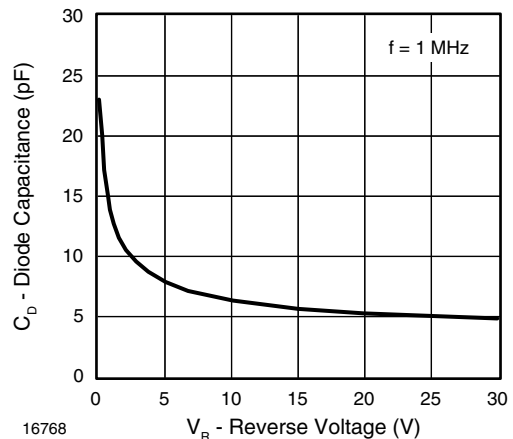

16768 Fig. 4 - Diode Capacitance vs. Reverse Voltage

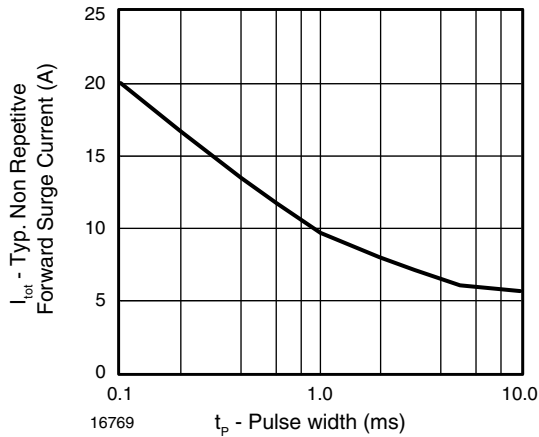
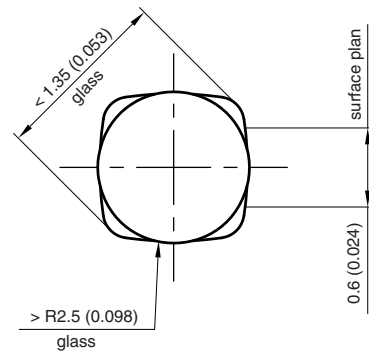
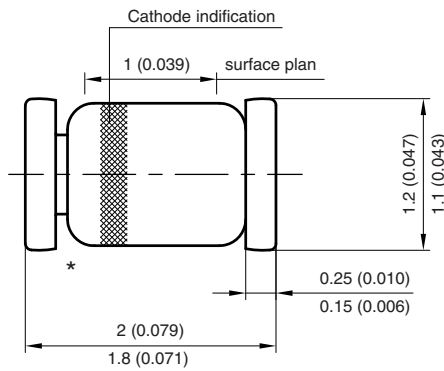

Fig. 5 - Typical Non-Repetitive Forward Surge Current vs. Pulse Width

## PACKAGE DIMENSIONS in millimeters (inches): MicroMELF



\* The gap between plug and glass can be either on cathode or anode side

Foot print recommendation:

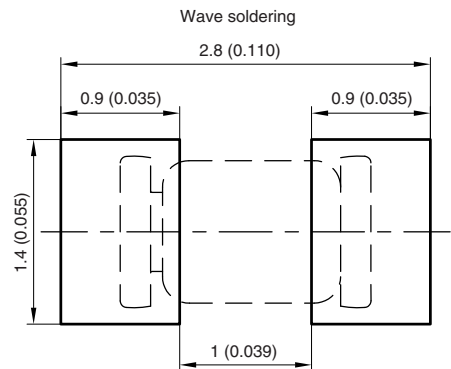
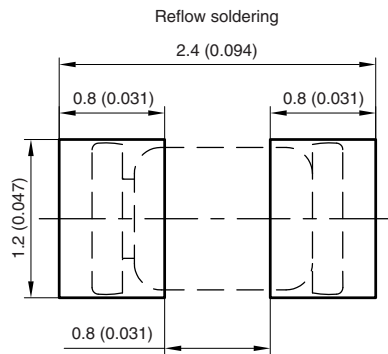

Created - Date: 26.July.1996  
 Rev. 13 - Date: 07.June.2006  
 Document no.:6.560-5007.01-4  
 96 12072



## Disclaimer

ALL PRODUCT, PRODUCT SPECIFICATIONS AND DATA ARE SUBJECT TO CHANGE WITHOUT NOTICE TO IMPROVE RELIABILITY, FUNCTION OR DESIGN OR OTHERWISE.

Vishay Intertechnology, Inc., its affiliates, agents, and employees, and all persons acting on its or their behalf (collectively, "Vishay"), disclaim any and all liability for any errors, inaccuracies or incompleteness contained in any datasheet or in any other disclosure relating to any product.

Vishay makes no warranty, representation or guarantee regarding the suitability of the products for any particular purpose or the continuing production of any product. To the maximum extent permitted by applicable law, Vishay disclaims (i) any and all liability arising out of the application or use of any product, (ii) any and all liability, including without limitation special, consequential or incidental damages, and (iii) any and all implied warranties, including warranties of fitness for particular purpose, non-infringement and merchantability.

Statements regarding the suitability of products for certain types of applications are based on Vishay's knowledge of typical requirements that are often placed on Vishay products in generic applications. Such statements are not binding statements about the suitability of products for a particular application. It is the customer's responsibility to validate that a particular product with the properties described in the product specification is suitable for use in a particular application. Parameters provided in datasheets and / or specifications may vary in different applications and performance may vary over time. All operating parameters, including typical parameters, must be validated for each customer application by the customer's technical experts. Product specifications do not expand or otherwise modify Vishay's terms and conditions of purchase, including but not limited to the warranty expressed therein.

Hyperlinks included in this datasheet may direct users to third-party websites. These links are provided as a convenience and for informational purposes only. Inclusion of these hyperlinks does not constitute an endorsement or an approval by Vishay of any of the products, services or opinions of the corporation, organization or individual associated with the third-party website. Vishay disclaims any and all liability and bears no responsibility for the accuracy, legality or content of the third-party website or for that of subsequent links.

Except as expressly indicated in writing, Vishay products are not designed for use in medical, life-saving, or life-sustaining applications or for any other application in which the failure of the Vishay product could result in personal injury or death. Customers using or selling Vishay products not expressly indicated for use in such applications do so at their own risk. Please contact authorized Vishay personnel to obtain written terms and conditions regarding products designed for such applications.

No license, express or implied, by estoppel or otherwise, to any intellectual property rights is granted by this document or by any conduct of Vishay. Product names and markings noted herein may be trademarks of their respective owners.