

# Noninverting 3-State Buffer

## MC74VHC1G125, MC74VHC1GT125

The MC74VHC1G125 / MC74VHC1GT125 is a single non-inverting 3-state buffer in tiny footprint packages. The MC74VHC1G125 has CMOS-level input thresholds while the MC74VHC1GT125 has TTL-level input thresholds.

The internal circuit is composed of three stages, including a buffered 3-state output which provides high noise immunity and stable output.

The input structures provide protection when voltages up to 5.5 V are applied, regardless of the supply voltage. This allows the device to be used to interface 5 V circuits to 3 V circuits. Some output structures also provide protection when  $V_{CC} = 0$  V and when the output voltage exceeds  $V_{CC}$ . These input and output structures help prevent device destruction caused by supply voltage – input/output voltage mismatch, battery backup, hot insertion, etc.

### Features

- Designed for 2.0 V to 5.5 V  $V_{CC}$  Operation
- 3.5 ns  $t_{PD}$  at 5 V (typ)
- Inputs/Outputs Over-Voltage Tolerant up to 5.5 V
- $I_{OFF}$  Supports Partial Power Down Protection
- Source/Sink 8 mA at 3.0 V
- Available in SC-88A, SC-74A, SOT-953 and UDFN6 Packages
- Chip Complexity < 100 FETs
- -Q Suffix for Automotive and Other Applications Requiring Unique Site and Control Change Requirements; AEC-Q100 Qualified and PPAP Capable
- These Devices are Pb-Free, Halogen Free/BFR Free and are RoHS Compliant

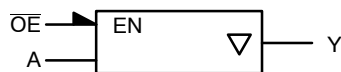
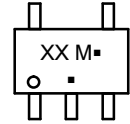

Figure 1. Logic Symbol

### MARKING DIAGRAMS



SC-88A  
DF SUFFIX  
CASE 419A



SC-74A  
DBV SUFFIX  
CASE 318BQ

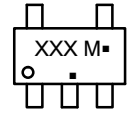

SOT-953  
P5 SUFFIX  
CASE 527AE

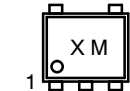

UDFN6  
1.45 x 1.0  
CASE 517AQ



UDFN6  
1.2 x 1.0  
CASE 517AA



UDFN6  
1.0 x 1.0  
CASE 517BX



XX = Specific Device Code  
M = Date Code\*  
▪ = Pb-Free Package

(Note: Microdot may be in either location)

\*Date Code orientation and/or position may vary depending upon manufacturing location.

### ORDERING INFORMATION

See detailed ordering, marking and shipping information in the package dimensions section on page 8 of this data sheet.

# MC74VHC1G125, MC74VHC1GT125

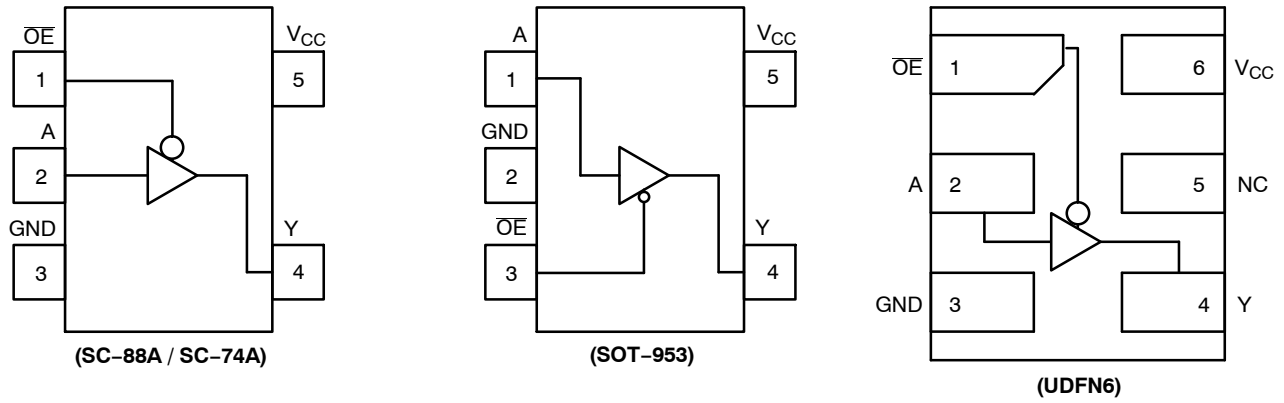

Figure 2. Pinout (Top View)

## PIN ASSIGNMENT (SC-88A / SC-74A)

Pin	Function
1	OE
2	A
3	GND
4	Y
5	V <sub>CC</sub>

## PIN ASSIGNMENT (SOT-953)

Pin	Function
1	A
2	GND
3	OE
4	Y
5	V <sub>CC</sub>

## PIN ASSIGNMENT (UDFN)

Pin	Function
1	OE
2	A
3	GND
4	Y
5	NC
6	V <sub>CC</sub>

## FUNCTION TABLE

Input		Output
OE	A	Y
L	L	L
L	H	H
H	X	Z

X = Don't Care

# MC74VHC1G125, MC74VHC1GT125

## MAXIMUM RATINGS

Symbol	Characteristics	Value	Unit	
V <sub>CC</sub>	DC Supply Voltage	-0.5 to +6.5	V	
V <sub>IN</sub>	DC Input Voltage	-0.5 to +6.5	V	
V <sub>OUT</sub>	DC Output Voltage Active-Mode (High or Low State) Tri-State Mode (Note 1) Power-Down Mode (V <sub>CC</sub> = 0 V)	-0.5 to V <sub>CC</sub> + 0.5 -0.5 to +6.5 -0.5 to +6.5	V	
I <sub>IK</sub>	DC Input Diode Current V <sub>IN</sub> < GND	-20	mA	
I <sub>OK</sub>	DC Output Diode Current V <sub>OUT</sub> < GND	-20	mA	
I <sub>OUT</sub>	DC Output Source/Sink Current	±25	mA	
I <sub>CC</sub> or I <sub>GND</sub>	DC Supply Current per Supply Pin or Ground Pin	±50	mA	
T <sub>STG</sub>	Storage Temperature Range	-65 to +150	°C	
T <sub>L</sub>	Lead Temperature, 1 mm from Case for 10 secs	260	°C	
T <sub>J</sub>	Junction Temperature Under Bias	+150	°C	
θ <sub>JA</sub>	Thermal Resistance (Note 2)	SC-88A SC-74A SOT-553 SOT-953 UDFN6	377 320 324 254 154	°C/W
P <sub>D</sub>	Power Dissipation in Still Air	SC-88A SC-74A SOT-553 SOT-953 UDFN6	332 390 386 491 812	mW
MSL	Moisture Sensitivity	Level 1	-	
F <sub>R</sub>	Flammability Rating Oxygen Index: 28 to 34	UL 94 V-0 @ 0.125 in	-	
V <sub>ESD</sub>	ESD Withstand Voltage (Note 3) Human Body Model Charged Device Model	2000 1000	V	
I <sub>Latchup</sub>	Latchup Performance (Note 4)	±100	mA	

Stresses exceeding those listed in the Maximum Ratings table may damage the device. If any of these limits are exceeded, device functionality should not be assumed, damage may occur and reliability may be affected.

1. Applicable to devices with outputs that may be tri-stated.
2. Measured with minimum pad spacing on an FR4 board, using 10mm-by-1inch, 2 ounce copper trace no air flow per JESD51-7.
3. HBM tested to ANSI/ESDA/JEDEC JS-001-2017. CDM tested to EIA/JESD22-C101-F. JEDEC recommends that ESD qualification to EIA/JESD22-A115-A (Machine Model) be discontinued per JEDEC/JEP172A.
4. Tested to EIA/JESD78 Class II.

# MC74VHC1G125, MC74VHC1GT125

## RECOMMENDED OPERATING CONDITIONS

Symbol	Characteristics	Min	Max	Unit
$V_{CC}$	Positive DC Supply Voltage	2.0	5.5	V
$V_{IN}$	DC Input Voltage	0	5.5	V
$V_{OUT}$	DC Output Voltage	0	$V_{CC}$	V
	Active-Mode (High or Low State)	0	5.5	
	Tri-State Mode (Note 1)	0	5.5	
	Power-Down Mode ( $V_{CC} = 0$ V)	0	5.5	
$T_A$	Operating Temperature Range	-55	+125	°C
$t_r, t_f$	Input Rise and Fall Time	0	20	ns/V
	$V_{CC} = 2.0$ V	0	20	
	$V_{CC} = 2.3$ V to $2.7$ V	0	20	
	$V_{CC} = 3.0$ V to $3.6$ V	0	10	
	$V_{CC} = 4.5$ V to $5.5$ V	0	5	

Functional operation above the stresses listed in the Recommended Operating Ranges is not implied. Extended exposure to stresses beyond the Recommended Operating Ranges limits may affect device reliability.

## DC ELECTRICAL CHARACTERISTICS (MC74VHC1G125)

Symbol	Parameter	Test Conditions	$V_{CC}$ (V)	$T_A = 25^\circ\text{C}$			$-40^\circ\text{C} \leq T_A \leq 85^\circ\text{C}$		$-55^\circ\text{C} \leq T_A \leq 125^\circ\text{C}$		Unit
				Min	Typ	Max	Min	Max	Min	Max	
$V_{IH}$	High-Level Input Voltage		2.0	1.5	-	-	1.5	-	1.5	-	V
			3.0	2.1	-	-	2.1	-	2.1	-	
			4.5	3.15	-	-	3.15	-	3.15	-	
			5.5	3.85	-	-	3.85	-	3.85	-	
$V_{IL}$	Low-Level Input Voltage		2.0	-	-	0.5	-	0.5	-	0.5	V
			3.0	-	-	0.9	-	0.9	-	0.9	
			4.5	-	-	1.35	-	1.35	-	1.35	
			5.5	-	-	1.65	-	1.65	-	1.65	
$V_{OH}$	High-Level Output Voltage	$V_{IN} = V_{IH}$ or $V_{IL}$ $I_{OH} = -50 \mu\text{A}$ $I_{OH} = -50 \mu\text{A}$ $I_{OH} = -50 \mu\text{A}$ $I_{OH} = -4 \text{ mA}$ $I_{OH} = -8 \text{ mA}$	2.0	1.9	2.0	-	1.9	-	1.9	-	V
			3.0	2.9	3.0	-	2.9	-	2.9	-	
			4.5	4.4	4.5	-	4.4	-	4.4	-	
			3.0	2.58	-	-	2.48	-	2.34	-	
			4.5	3.94	-	-	3.80	-	3.66	-	
$V_{OL}$	Low-Level Output Voltage	$V_{IN} = V_{IH}$ or $V_{IL}$ $I_{OL} = 50 \mu\text{A}$ $I_{OL} = 50 \mu\text{A}$ $I_{OL} = 50 \mu\text{A}$ $I_{OL} = 4 \text{ mA}$ $I_{OL} = 8 \text{ mA}$	2.0	-	0.0	0.1	-	0.1	-	0.1	V
			3.0	-	0.0	0.1	-	0.1	-	0.1	
			4.5	-	0.0	0.1	-	0.1	-	0.1	
			3.0	-	-	0.36	-	0.44	-	0.52	
			4.5	-	-	0.36	-	0.44	-	0.52	
$I_{IN}$	Input Leakage Current	$V_{IN} = 5.5$ V or GND	2.0 to 5.5	-	-	$\pm 0.1$	-	$\pm 1.0$	-	$\pm 1.0$	$\mu\text{A}$
$I_{OZ}$	3-State Output Leakage Current	$V_{OUT} = 0$ V to $5.5$ V	5.5	-	-	$\pm 0.25$	-	$\pm 2.5$	-	$\pm 2.5$	$\mu\text{A}$
$I_{OFF}$	Power Off Leakage Current	$V_{IN} = 5.5$ V or $V_{OUT} = 5.5$ V	0.0	-	-	1.0	-	10	-	10	$\mu\text{A}$
$I_{CC}$	Quiescent Supply Current	$V_{IN} = V_{CC}$ or GND	5.5	-	-	1.0	-	20	-	40	$\mu\text{A}$

# MC74VHC1G125, MC74VHC1GT125

## DC ELECTRICAL CHARACTERISTICS (MC74VHC1GT125)

Symbol	Parameter	Test Conditions	V <sub>CC</sub> (V)	T <sub>A</sub> = 25°C			-40°C ≤ T <sub>A</sub> ≤ 85°C		-55°C ≤ T <sub>A</sub> ≤ 125°C		Unit
				Min	Typ	Max	Min	Max	Min	Max	
V <sub>IH</sub>	High-Level Input Voltage		2.0	1.0	-	-	1.0	-	1.0	-	V
			3.0	1.4	-	-	1.4	-	1.4	-	
			4.5	2.0	-	-	2.0	-	2.0	-	
			5.5	2.0	-	-	2.0	-	2.0	-	
V <sub>IL</sub>	Low-Level Input Voltage		2.0	-	-	0.28	-	0.28	-	0.28	V
			3.0	-	-	0.45	-	0.45	-	0.45	
			4.5	-	-	0.8	-	0.8	-	0.8	
			5.5	-	-	0.8	-	0.8	-	0.8	
V <sub>OH</sub>	High-Level Output Voltage	V <sub>IN</sub> = V <sub>IH</sub> or V <sub>IL</sub> I <sub>OH</sub> = -50 μA I <sub>OH</sub> = -50 μA I <sub>OH</sub> = -50 μA I <sub>OH</sub> = -4 mA I <sub>OH</sub> = -8 mA	2.0	1.9	2.0	-	1.9	-	1.9	-	V
			3.0	2.9	3.0	-	2.9	-	2.9	-	
			4.5	4.4	4.5	-	4.4	-	4.4	-	
			3.0	2.58	-	-	2.48	-	2.34	-	
			4.5	3.94	-	-	3.80	-	3.66	-	
V <sub>OL</sub>	Low-Level Output Voltage	V <sub>IN</sub> = V <sub>IH</sub> or V <sub>IL</sub> I <sub>OL</sub> = 50 μA I <sub>OL</sub> = 50 μA I <sub>OL</sub> = 50 μA I <sub>OL</sub> = 4 mA I <sub>OL</sub> = 8 mA	2.0	-	0.0	0.1	-	0.1	-	0.1	V
			3.0	-	0.0	0.1	-	0.1	-	0.1	
			4.5	-	0.0	0.1	-	0.1	-	0.1	
			3.0	-	-	0.36	-	0.44	-	0.52	
			4.5	-	-	0.36	-	0.44	-	0.52	
I <sub>IN</sub>	Input Leakage Current	V <sub>IN</sub> = 5.5 V or GND	2.0 to 5.5	-	-	±0.1	-	±1.0	-	±1.0	μA
I <sub>OZ</sub>	3-State Output Leakage Current	V <sub>OUT</sub> = 0 V to 5.5 V	5.5	-	-	±0.25	-	±2.5	-	±2.5	μA
I <sub>OFF</sub>	Power Off Leakage Current	V <sub>IN</sub> = 5.5 V or V <sub>OUT</sub> = 5.5 V	0	-	-	1.0	-	10	-	10	μA
I <sub>CC</sub>	Quiescent Supply Current	V <sub>IN</sub> = V <sub>CC</sub> or GND	5.5	-	-	1.0	-	20	-	40	μA
I <sub>CCCT</sub>	Increase in Quiescent Supply Current per Input Pin	One Input: V <sub>IN</sub> = 3.4 V; Other Input at V <sub>CC</sub> or GND	5.5	-	-	1.35	-	1.5	-	1.65	mA

# MC74VHC1G125, MC74VHC1GT125

## AC ELECTRICAL CHARACTERISTICS

Symbol	Parameter	Conditions	V <sub>CC</sub> (V)	T <sub>A</sub> = 25°C			-40°C ≤ T <sub>A</sub> ≤ 85°C		-55°C ≤ T <sub>A</sub> ≤ 125°C		Unit
				Min	Typ	Max	Min	Max	Min	Max	
t <sub>PLH</sub> , t <sub>PHL</sub>	Propagation Delay, A to Y (Figures 3 and 4)	C <sub>L</sub> = 15 pF	3.0 to 3.6	-	4.5	8.0	-	9.5	-	12.0	ns
		C <sub>L</sub> = 50 pF		-	6.4	11.5	-	13.0	-	16.0	
		C <sub>L</sub> = 15 pF	4.5 to 5.5	-	3.5	5.5	-	6.5	-	8.5	
		C <sub>L</sub> = 50 pF		-	4.5	7.5	-	8.5	-	10.5	
t <sub>PZL</sub> , t <sub>PZH</sub>	Output Enable Time, $\overline{OE}$ to Y (Figures 3 and 4)	C <sub>L</sub> = 15 pF	3.0 to 3.6	-	4.5	8.0	-	9.5	-	11.5	ns
		C <sub>L</sub> = 50 pF		-	6.4	11.5	-	13.0	-	15.0	
		C <sub>L</sub> = 15 pF	4.5 to 5.5	-	3.5	5.1	-	6.0	-	8.5	
		C <sub>L</sub> = 50 pF		-	4.5	7.1	-	8.0	-	10.5	
t <sub>PLZ</sub> , t <sub>PHZ</sub>	Output Disable Time, OE to Y (Figures 3 and 4)	C <sub>L</sub> = 15 pF	3.0 to 3.6	-	6.5	9.7	-	11.5	-	14.5	ns
		C <sub>L</sub> = 50 pF		-	8.0	13.2	-	15.0	-	18.0	
		C <sub>L</sub> = 15 pF	4.5 to 5.5	-	4.8	6.8	-	8.0	-	10.0	
		C <sub>L</sub> = 50 pF		-	7.0	8.8	-	10.0	-	12.0	
C <sub>IN</sub>	Input Capacitance			-	4.0	10	-	10	-	10	pF
C <sub>OUT</sub>	Output Capacitance	Output in High Impedance State		-	6.0	-	-	-	-	-	pF

C <sub>PD</sub>	Power Dissipation Capacitance (Note 5)	<b>Typical @ 25°C, V<sub>CC</sub> = 5.0 V</b>	pF
		8.0	

5. C<sub>PD</sub> is defined as the value of the internal equivalent capacitance which is calculated from the operating current consumption without load. Average operating current can be obtained by the equation: I<sub>CC(OPR)</sub> = C<sub>PD</sub> • V<sub>CC</sub> • f<sub>in</sub> + I<sub>CC</sub>. C<sub>PD</sub> is used to determine the no-load dynamic power consumption; P<sub>D</sub> = C<sub>PD</sub> • V<sub>CC</sub><sup>2</sup> • f<sub>in</sub> + I<sub>CC</sub> • V<sub>CC</sub>.

# MC74VHC1G125, MC74VHC1GT125

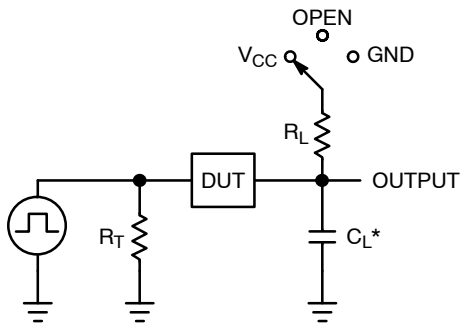

$C_L$  includes probe and jig capacitance  
 $R_T$  is  $Z_{OUT}$  of pulse generator (typically 50  $\Omega$ )  
 $f = 1$  MHz

**Figure 3. Test Circuit**

Test	Switch Position	$C_L$ , pF	$R_L$ , $\Omega$
$t_{PLH} / t_{PHL}$	Open	See AC Characteristics Table	X
$t_{PLZ} / t_{PZL}$	$V_{CC}$		1 k
$t_{PHZ} / t_{PZH}$	GND		1 k

X = Don't Care



**Figure 4. Switching Waveforms**

$V_{CC}$ , V	$V_{mi}$ , V	$V_{mo}$ , V		$V_Y$ , V
		$t_{PLH}$ , $t_{PHL}$	$t_{PZL}$ , $t_{PLZ}$ , $t_{PZH}$ , $t_{PHZ}$	
3.0 to 3.6	$V_{CC}/2$	$V_{CC}/2$	$V_{CC}/2$	0.3
4.5 to 5.5	$V_{CC}/2$	$V_{CC}/2$	$V_{CC}/2$	0.3

# MC74VHC1G125, MC74VHC1GT125

## ORDERING INFORMATION

Device	Packages	Specific Device Code	Pin 1 Orientation (See below)	Shipping <sup>†</sup>
MC74VHC1G125DFT1G	SC-88A	W0	Q2	3000 / Tape & Reel
MC74VHC1G125DFT2G	SC-88A	W0	Q4	3000 / Tape & Reel
MC74VHC1G125DFT1G-Q*	SC-88A	W0	Q2	3000 / Tape & Reel
MC74VHC1G125DFT2G-Q*	SC-88A	W0	Q4	3000 / Tape & Reel
MC74VHC1GT125DFT1G	SC-88A	W1	Q2	3000 / Tape & Reel
MC74VHC1GT125DFT2G	SC-88A	W1	Q4	3000 / Tape & Reel
MC74VHC1GT125DFT1G-Q*	SC-88A	W1	Q2	3000 / Tape & Reel
MC74VHC1GT125DFT2G-Q*	SC-88A	W1	Q4	3000 / Tape & Reel
MC74VHC1G125DBVT1G	SC-74A	W0	Q4	3000 / Tape & Reel
MC74VHC1GT125DBVT1G	SC-74A	W1	Q4	3000 / Tape & Reel
MC74VHC1G125P5T5G	SOT-953	T	Q2	8000 / Tape & Reel
MC74VHC1GT125P5T5G (Contact <b>onsemi</b> )	SOT-953	TBD	Q2	8000 / Tape & Reel
MC74VHC1G125MU1TCG (Contact <b>onsemi</b> )	UDFN6, 1.45 x 1.0, 0.5P	TBD	Q4	3000 / Tape & Reel
MC74VHC1GT125MU1TCG	UDFN6, 1.45 x 1.0, 0.5P	D	Q4	3000 / Tape & Reel
MC74VHC1GT125MU2TCG	UDFN6, 1.2 x 1.0, 0.4P	7	Q4	3000 / Tape & Reel
MC74VHC1G125MU3TCG (Contact <b>onsemi</b> )	UDFN6, 1.0 x 1.0, 0.35P	TBD	Q4	3000 / Tape & Reel
MC74VHC1GT125MU3TCG	UDFN6, 1.0 x 1.0, 0.35P	L	Q4	3000 / Tape & Reel

<sup>†</sup>For information on tape and reel specifications, including part orientation and tape sizes, please refer to our Tape and Reel Packaging Specifications Brochure, BRD8011/D.

\*-Q Suffix for Automotive and Other Applications Requiring Unique Site and Control Change Requirements; AEC-Q100 Qualified and PPAP Capable.

### Pin 1 Orientation in Tape and Reel

Direction of Feed

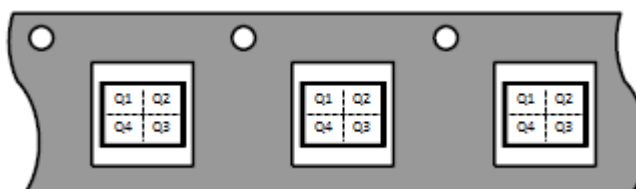



# MECHANICAL CASE OUTLINE

## PACKAGE DIMENSIONS

ON Semiconductor®

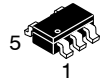

SCALE 2:1

### SC-74A CASE 318BQ ISSUE B

DATE 18 JAN 2018

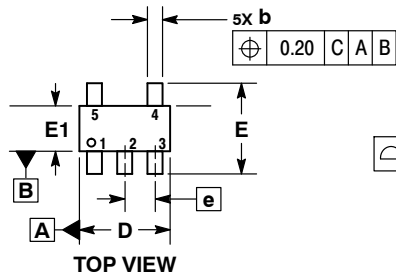

TOP VIEW

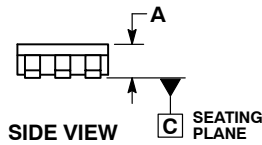

SIDE VIEW

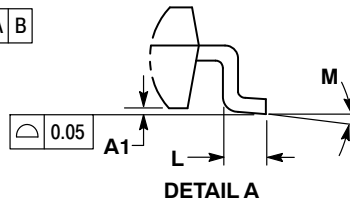

DETAIL A

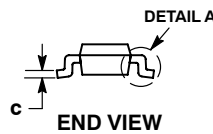

END VIEW

NOTES:

1. DIMENSIONING AND TOLERANCING PER ASME Y14.5M, 1994.
2. CONTROLLING DIMENSION: MILLIMETERS.
3. MAXIMUM LEAD THICKNESS INCLUDES LEAD FINISH THICKNESS. MINIMUM LEAD THICKNESS IS THE MINIMUM THICKNESS OF BASE MATERIAL.
4. DIMENSIONS A AND B DO NOT INCLUDE MOLD FLASH, PROTRUSIONS, OR GATE BURRS. MOLD FLASH, PROTRUSIONS, OR GATE BURRS SHALL NOT EXCEED 0.15 PER SIDE.

DIM	MILLIMETERS	
	MIN	MAX
A	0.90	1.10
A1	0.01	0.10
b	0.25	0.50
c	0.10	0.26
D	2.85	3.15
E	2.50	3.00
E1	1.35	1.65
e	0.95 BSC	
L	0.20	0.60
M	0°	10°

#### RECOMMENDED SOLDERING FOOTPRINT\*

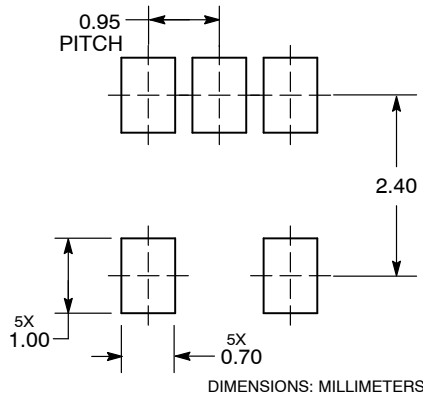

#### GENERIC MARKING DIAGRAM\*

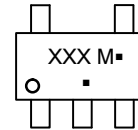

- XXX = Specific Device Code
- M = Date Code
- = Pb-Free Package

(Note: Microdot may be in either location)

\*This information is generic. Please refer to device data sheet for actual part marking. Pb-Free indicator, "G" or microdot "▪", may or may not be present. Some products may not follow the Generic Marking.

\*For additional information on our Pb-Free strategy and soldering details, please download the ON Semiconductor Soldering and Mounting Techniques Reference Manual, SOLDERRM/D.

<b>DOCUMENT NUMBER:</b>	<b>98AON66279G</b>	Electronic versions are uncontrolled except when accessed directly from the Document Repository. Printed versions are uncontrolled except when stamped "CONTROLLED COPY" in red.
<b>DESCRIPTION:</b>	<b>SC-74A</b>	<b>PAGE 1 OF 1</b>

ON Semiconductor and are trademarks of Semiconductor Components Industries, LLC dba ON Semiconductor or its subsidiaries in the United States and/or other countries. ON Semiconductor reserves the right to make changes without further notice to any products herein. ON Semiconductor makes no warranty, representation or guarantee regarding the suitability of its products for any particular purpose, nor does ON Semiconductor assume any liability arising out of the application or use of any product or circuit, and specifically disclaims any and all liability, including without limitation special, consequential or incidental damages. ON Semiconductor does not convey any license under its patent rights nor the rights of others.

# MECHANICAL CASE OUTLINE PACKAGE DIMENSIONS



SCALE 2:1

## SC-88A (SC-70-5/SOT-353) CASE 419A-02 ISSUE M

DATE 11 APR 2023

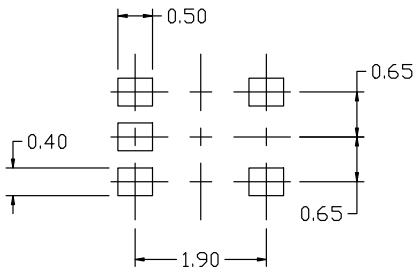

### RECOMMENDED MOUNTING FOOTPRINT

\* For additional information on our Pb-Free strategy and soldering details, please download the ON Semiconductor Soldering and Mounting Techniques Reference Manual, SOLDERM/D.

### NOTES:

1. DIMENSIONING AND TOLERANCING PER ANSI Y14.5M, 1982.
2. CONTROLLING DIMENSION: MILLIMETERS
3. 419A-01 OBSOLETE. NEW STANDARD 419A-02
4. DIMENSIONS D AND E1 DO NOT INCLUDE MOLD FLASH, PROTRUSIONS, OR GATE BURRS. MOLD FLASH, PROTRUSIONS, OR GATE BURRS SHALL NOT EXCEED 0.1016MM PER SIDE.

DIM	MILLIMETERS		
	MIN.	NOM.	MAX.
A	0.80	0.95	1.10
A1	---	---	0.10
A3	0.20 REF		
b	0.10	0.20	0.30
c	0.10	---	0.25
D	1.80	2.00	2.20
E	2.00	2.10	2.20
E1	1.15	1.25	1.35
e	0.65 BSC		
L	0.10	0.15	0.30

### GENERIC MARKING DIAGRAM\*

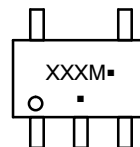

\*This information is generic. Please refer to device data sheet for actual part marking. Pb-Free indicator, "G" or microdot "▪", may or may not be present. Some products may not follow the Generic Marking.

XXX = Specific Device Code

M = Date Code

▪ = Pb-Free Package

(Note: Microdot may be in either location)

#### STYLE 1:

1. BASE
2. EMITTER
3. BASE
4. COLLECTOR
5. COLLECTOR

#### STYLE 2:

1. ANODE
2. EMITTER
3. BASE
4. COLLECTOR
5. CATHODE

#### STYLE 3:

1. ANODE 1
2. N/C
3. ANODE 2
4. CATHODE 2
5. CATHODE 1

#### STYLE 4:

1. SOURCE 1
2. DRAIN 1/2
3. SOURCE 1
4. GATE 1
5. GATE 2

#### STYLE 5:

1. CATHODE
2. COMMON ANODE
3. CATHODE 2
4. CATHODE 3
5. CATHODE 4

#### STYLE 6:

1. EMITTER 2
2. BASE 2
3. EMITTER 1
4. COLLECTOR
5. COLLECTOR 2/BASE 1

#### STYLE 7:

1. BASE
2. EMITTER
3. BASE
4. COLLECTOR
5. COLLECTOR

#### STYLE 8:

1. CATHODE
2. COLLECTOR
3. N/C
4. BASE
5. EMITTER

#### STYLE 9:

1. ANODE
2. CATHODE
3. ANODE
4. ANODE
5. ANODE

Note: Please refer to datasheet for style callout. If style type is not called out in the datasheet refer to the device datasheet pinout or pin assignment.

<b>DOCUMENT NUMBER:</b>	<b>98ASB42984B</b>	Electronic versions are uncontrolled except when accessed directly from the Document Repository. Printed versions are uncontrolled except when stamped "CONTROLLED COPY" in red.
<b>DESCRIPTION:</b>	<b>SC-88A (SC-70-5/SOT-353)</b>	<b>PAGE 1 OF 1</b>

onsemi and ONSEMI are trademarks of Semiconductor Components Industries, LLC dba onsemi or its subsidiaries in the United States and/or other countries. onsemi reserves the right to make changes without further notice to any products herein. onsemi makes no warranty, representation or guarantee regarding the suitability of its products for any particular purpose, nor does onsemi assume any liability arising out of the application or use of any product or circuit, and specifically disclaims any and all liability, including without limitation special, consequential or incidental damages. onsemi does not convey any license under its patent rights nor the rights of others.

# MECHANICAL CASE OUTLINE

## PACKAGE DIMENSIONS



UDFN6, 1.2x1.0, 0.4P  
CASE 517AA  
ISSUE D

DATE 03 SEP 2010

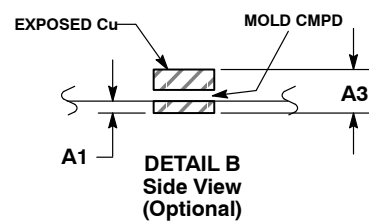
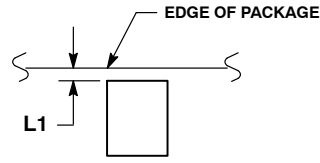
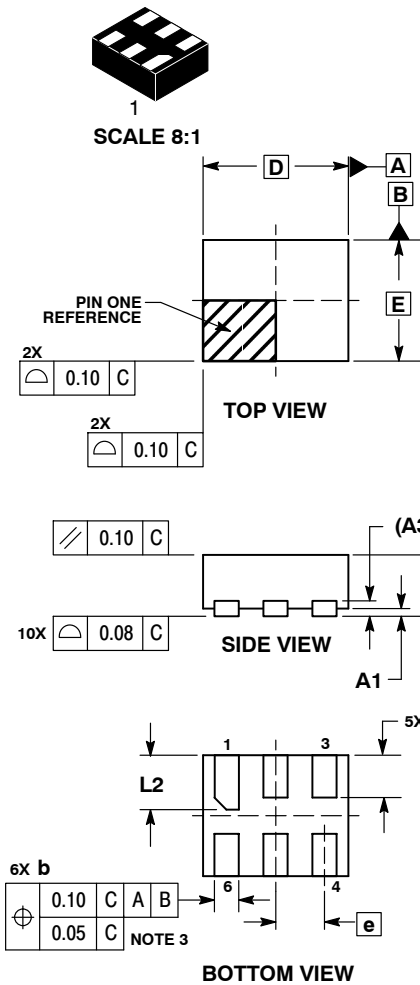

- NOTES:
1. DIMENSIONING AND TOLERANCING PER ASME Y14.5M, 1994.
  2. CONTROLLING DIMENSION: MILLIMETERS.
  3. DIMENSION b APPLIES TO PLATED TERMINAL AND IS MEASURED BETWEEN 0.25 AND 0.30 mm FROM TERMINAL.
  4. COPLANARITY APPLIES TO THE EXPOSED PAD AS WELL AS THE TERMINALS.

MILLIMETERS		
DIM	MIN	MAX
A	0.45	0.55
A1	0.00	0.05
A3	0.127	REF
b	0.15	0.25
D	1.20	BSC
E	1.00	BSC
e	0.40	BSC
L	0.30	0.40
L1	0.00	0.15
L2	0.40	0.50

### GENERIC MARKING DIAGRAM\*



X = Specific Device Code  
M = Date Code

\*This information is generic. Please refer to device data sheet for actual part marking. Pb-Free indicator, "G" or microdot "▪", may or may not be present.

### MOUNTING FOOTPRINT\*

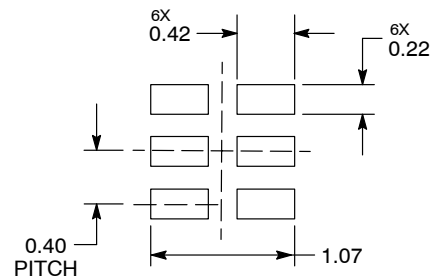

DIMENSIONS: MILLIMETERS

\*For additional information on our Pb-Free strategy and soldering details, please download the ON Semiconductor Soldering and Mounting Techniques Reference Manual, SOLDERRM/D.

<b>DOCUMENT NUMBER:</b>	<b>98AON22068D</b>	Electronic versions are uncontrolled except when accessed directly from the Document Repository. Printed versions are uncontrolled except when stamped "CONTROLLED COPY" in red.
<b>DESCRIPTION:</b>	<b>6 PIN UDFN, 1.2X1.0, 0.4P</b>	<b>PAGE 1 OF 1</b>

onsemi and onsemi are trademarks of Semiconductor Components Industries, LLC dba onsemi or its subsidiaries in the United States and/or other countries. onsemi reserves the right to make changes without further notice to any products herein. onsemi makes no warranty, representation or guarantee regarding the suitability of its products for any particular purpose, nor does onsemi assume any liability arising out of the application or use of any product or circuit, and specifically disclaims any and all liability, including without limitation special, consequential or incidental damages. onsemi does not convey any license under its patent rights nor the rights of others.

# MECHANICAL CASE OUTLINE PACKAGE DIMENSIONS



SCALE 4:1

UDFN6, 1.45x1.0, 0.5P  
CASE 517AQ  
ISSUE O

DATE 15 MAY 2008

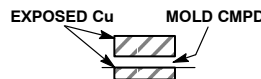

- NOTES:
1. DIMENSIONING AND TOLERANCING PER ASME Y14.5M, 1994.
  2. CONTROLLING DIMENSION: MILLIMETERS.
  3. DIMENSION b APPLIES TO PLATED TERMINAL AND IS MEASURED BETWEEN 0.15 AND 0.30 mm FROM THE TERMINAL TIP.

MILLIMETERS		
DIM	MIN	MAX
A	0.45	0.55
A1	0.00	0.05
A2	0.07	REF
b	0.20	0.30
D	1.45	BSC
E	1.00	BSC
e	0.50	BSC
L	0.30	0.40
L1	---	0.15

### MOUNTING FOOTPRINT

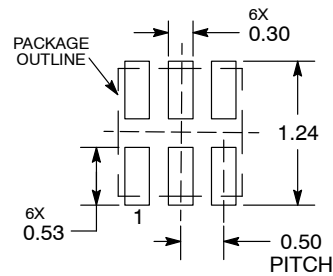

DIMENSIONS: MILLIMETERS

\*For additional information on our Pb-Free strategy and soldering details, please download the ON Semiconductor Soldering and Mounting Techniques Reference Manual, SOLDERRM/D.

### GENERIC MARKING DIAGRAM\*



X = Specific Device Code  
M = Date Code

\*This information is generic. Please refer to device data sheet for actual part marking. Pb-Free indicator, "G" or microdot "▪", may or may not be present.

<b>DOCUMENT NUMBER:</b>	<b>98AON30313E</b>	Electronic versions are uncontrolled except when accessed directly from the Document Repository. Printed versions are uncontrolled except when stamped "CONTROLLED COPY" in red.
<b>DESCRIPTION:</b>	<b>UDFN6, 1.45x1.0, 0.5P</b>	<b>PAGE 1 OF 1</b>

onsemi and ONsemi are trademarks of Semiconductor Components Industries, LLC dba onsemi or its subsidiaries in the United States and/or other countries. onsemi reserves the right to make changes without further notice to any products herein. onsemi makes no warranty, representation or guarantee regarding the suitability of its products for any particular purpose, nor does onsemi assume any liability arising out of the application or use of any product or circuit, and specifically disclaims any and all liability, including without limitation special, consequential or incidental damages. onsemi does not convey any license under its patent rights nor the rights of others.

# MECHANICAL CASE OUTLINE PACKAGE DIMENSIONS



UDFN6, 1x1, 0.35P  
CASE 517BX  
ISSUE O

SCALE 4:1

DATE 18 MAY 2011



- NOTES:
1. DIMENSIONING AND TOLERANCING PER ASME Y14.5M, 1994.
  2. CONTROLLING DIMENSION: MILLIMETERS.
  3. DIMENSION b APPLIES TO PLATED TERMINAL AND IS MEASURED BETWEEN 0.15 AND 0.20 MM FROM TERMINAL TIP.
  4. PACKAGE DIMENSIONS EXCLUSIVE OF BURRS AND MOLD FLASH.

MILLIMETERS		
DIM	MIN	MAX
A	0.45	0.55
A1	0.00	0.05
A3	0.13	REF
b	0.12	0.22
D	1.00	BSC
E	1.00	BSC
e	0.35	BSC
L	0.25	0.35
L1	0.30	0.40

### RECOMMENDED SOLDERING FOOTPRINT\*

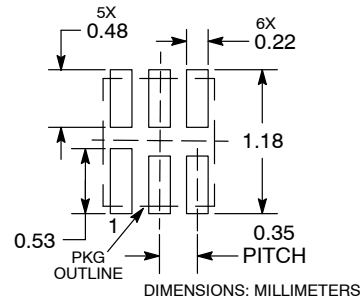

\*For additional information on our Pb-Free strategy and soldering details, please download the ON Semiconductor Soldering and Mounting Techniques Reference Manual, SOLDERRM/D.

### GENERIC MARKING DIAGRAM\*

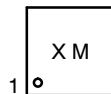

X = Specific Device Code  
M = Date Code

\*This information is generic. Please refer to device data sheet for actual part marking. Pb-Free indicator, "G" or microdot "▪", may or may not be present. Some products may not follow the Generic Marking.

<b>DOCUMENT NUMBER:</b>	<b>98AON56787E</b>	Electronic versions are uncontrolled except when accessed directly from the Document Repository. Printed versions are uncontrolled except when stamped "CONTROLLED COPY" in red.
<b>DESCRIPTION:</b>	<b>UDFN6, 1x1, 0.35P</b>	<b>PAGE 1 OF 1</b>

onsemi and onsemi are trademarks of Semiconductor Components Industries, LLC dba onsemi or its subsidiaries in the United States and/or other countries. onsemi reserves the right to make changes without further notice to any products herein. onsemi makes no warranty, representation or guarantee regarding the suitability of its products for any particular purpose, nor does onsemi assume any liability arising out of the application or use of any product or circuit, and specifically disclaims any and all liability, including without limitation special, consequential or incidental damages. onsemi does not convey any license under its patent rights nor the rights of others.

# MECHANICAL CASE OUTLINE PACKAGE DIMENSIONS

ON Semiconductor®



SCALE 4:1

**SOT-953**  
CASE 527AE  
ISSUE E

DATE 02 AUG 2011



TOP VIEW



SIDE VIEW

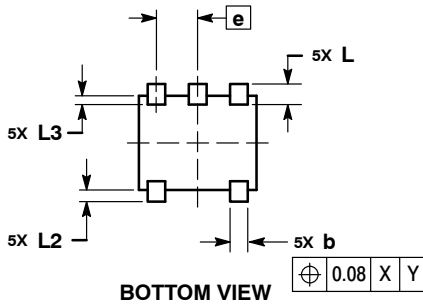

BOTTOM VIEW

### SOLDERING FOOTPRINT\*

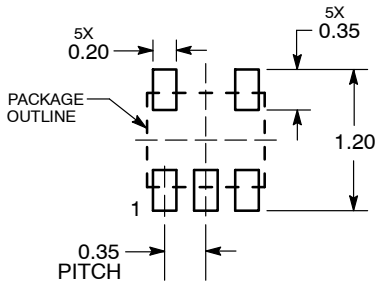

DIMENSIONS: MILLIMETERS

### NOTES:

1. DIMENSIONING AND TOLERANCING PER ASME Y14.5M, 1994.
2. CONTROLLING DIMENSION: MILLIMETERS
3. MAXIMUM LEAD THICKNESS INCLUDES LEAD FINISH. MINIMUM LEAD THICKNESS IS THE MINIMUM THICKNESS OF THE BASE MATERIAL.
4. DIMENSIONS D AND E DO NOT INCLUDE MOLD FLASH, PROTRUSIONS, OR GATE BURRS.

DIM	MILLIMETERS		
	MIN	NOM	MAX
A	0.34	0.37	0.40
b	0.10	0.15	0.20
C	0.07	0.12	0.17
D	0.95	1.00	1.05
E	0.75	0.80	0.85
e	0.35 BSC		
HE	0.95	1.00	1.05
L	0.175 REF		
L2	0.05	0.10	0.15
L3	---	---	0.15

### GENERIC MARKING DIAGRAM\*

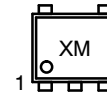

X = Specific Device Code  
M = Month Code

\*This information is generic. Please refer to device data sheet for actual part marking.

Pb-Free indicator, "G" or microdot "▪", may or may not be present.

\*For additional information on our Pb-Free strategy and soldering details, please download the ON Semiconductor Soldering and Mounting Techniques Reference Manual, SOLDERRM/D.

<b>DOCUMENT NUMBER:</b>	<b>98AON26457D</b>	Electronic versions are uncontrolled except when accessed directly from the Document Repository. Printed versions are uncontrolled except when stamped "CONTROLLED COPY" in red.
<b>DESCRIPTION:</b>	<b>SOT-953</b>	<b>PAGE 1 OF 1</b>

ON Semiconductor and are trademarks of Semiconductor Components Industries, LLC dba ON Semiconductor or its subsidiaries in the United States and/or other countries. ON Semiconductor reserves the right to make changes without further notice to any products herein. ON Semiconductor makes no warranty, representation or guarantee regarding the suitability of its products for any particular purpose, nor does ON Semiconductor assume any liability arising out of the application or use of any product or circuit, and specifically disclaims any and all liability, including without limitation special, consequential or incidental damages. ON Semiconductor does not convey any license under its patent rights nor the rights of others.

**onsemi**, **Onsemi**, and other names, marks, and brands are registered and/or common law trademarks of Semiconductor Components Industries, LLC dba "**onsemi**" or its affiliates and/or subsidiaries in the United States and/or other countries. **onsemi** owns the rights to a number of patents, trademarks, copyrights, trade secrets, and other intellectual property. A listing of **onsemi**'s product/patent coverage may be accessed at [www.onsemi.com/site/pdf/Patent-Marking.pdf](http://www.onsemi.com/site/pdf/Patent-Marking.pdf). **onsemi** reserves the right to make changes at any time to any products or information herein, without notice. The information herein is provided "as-is" and **onsemi** makes no warranty, representation or guarantee regarding the accuracy of the information, product features, availability, functionality, or suitability of its products for any particular purpose, nor does **onsemi** assume any liability arising out of the application or use of any product or circuit, and specifically disclaims any and all liability, including without limitation special, consequential or incidental damages. Buyer is responsible for its products and applications using **onsemi** products, including compliance with all laws, regulations and safety requirements or standards, regardless of any support or applications information provided by **onsemi**. "Typical" parameters which may be provided in **onsemi** data sheets and/or specifications can and do vary in different applications and actual performance may vary over time. All operating parameters, including "Typicals" must be validated for each customer application by customer's technical experts. **onsemi** does not convey any license under any of its intellectual property rights nor the rights of others. **onsemi** products are not designed, intended, or authorized for use as a critical component in life support systems or any FDA Class 3 medical devices or medical devices with a same or similar classification in a foreign jurisdiction or any devices intended for implantation in the human body. Should Buyer purchase or use **onsemi** products for any such unintended or unauthorized application, Buyer shall indemnify and hold **onsemi** and its officers, employees, subsidiaries, affiliates, and distributors harmless against all claims, costs, damages, and expenses, and reasonable attorney fees arising out of, directly or indirectly, any claim of personal injury or death associated with such unintended or unauthorized use, even if such claim alleges that **onsemi** was negligent regarding the design or manufacture of the part. **onsemi** is an Equal Opportunity/Affirmative Action Employer. This literature is subject to all applicable copyright laws and is not for resale in any manner.

## ADDITIONAL INFORMATION

### TECHNICAL PUBLICATIONS:

Technical Library: [www.onsemi.com/design/resources/technical-documentation](http://www.onsemi.com/design/resources/technical-documentation)  
onsemi Website: [www.onsemi.com](http://www.onsemi.com)

### ONLINE SUPPORT: [www.onsemi.com/support](http://www.onsemi.com/support)

For additional information, please contact your local Sales Representative at [www.onsemi.com/support/sales](http://www.onsemi.com/support/sales)