

Click [here](#) to ask an associate for production status of specific part numbers.

MAX49921

0 to 70V, High-Precision Current-Sense Amplifier

General Description

The MAX49921 is high-precision, unidirectional current-sense amplifier (CSA) with an operating input common-mode range from 0 to +70V, though the device is protected against input common-mode voltages down to -42V and up to +80V, thus providing protection against reverse-battery and high-voltage spikes. The MAX49921 is well-suited for current monitoring of inductive loads, such as DC motors and solenoids, where common-mode voltages can become negative due to inductive kickback, reverse-battery conditions, or transient events.

The low input offset of $\pm 0.5\mu\text{V}$ (typ) and low gain error of $\pm 0.05\%$ (typ) make this device best-suited for high-precision current measurements.

The MAX49921 operates from a supply voltage of +2.7V to +5.5V with a typical quiescent supply at 0.7mA. This device is specified over the full -40°C to $+125^\circ\text{C}$ automotive temperature range and is AEC-Q100 qualified. The MAX49921 is offered in a 2mm x 3mm, 8-pin, side-wettable TDFN package with gain options of 20V/V and 50V/V.

Applications

- Solenoid Current Sensing
- Battery Current Monitoring
- Current Monitoring of Inductive Loads
- High- and Low-Side Precision Current Sensing
- Supercapacitor Charge/Discharge Monitoring
- Precision High-Voltage Current Monitoring
- Automotive Current Sensing

Benefits and Features

- AEC-Q100 Qualified for Automotive Applications
- $\pm 0.5\mu\text{V}$ (typ) Input Offset Voltage
- $\pm 0.05\%$ (typ) Gain Error
- 0 to +70V Input Voltage Range
- -42V to +80V Protective Immunity
- 65kHz, -3dB Bandwidth
- 140dB DC CMRR
- Gain Options: 20V/V, 50V/V
- Rail-to-Rail Output
- 2mm x 3mm, 8-Pin TDFN Package
- -40°C to $+125^\circ\text{C}$ Automotive Temperature Range

[Ordering Information](#) appears at end of data sheet.

Simplified Block Diagram

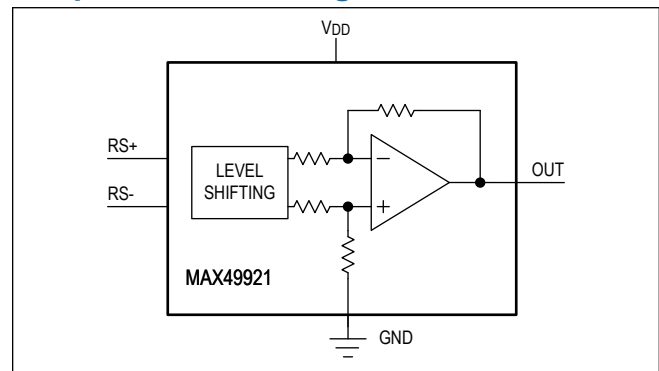

[Ordering Information](#) appears at end of data sheet.

19-100848; Rev 1; 9/21

© 2021 Analog Devices, Inc. All rights reserved. Trademarks and registered trademarks are the property of their respective owners.

One Analog Way, Wilmington, MA 01887 U.S.A. | Tel: 781.329.4700 | © 2021 Analog Devices, Inc. All rights reserved.

TABLE OF CONTENTS

General Description	1
Applications	1
Benefits and Features	1
Simplified Block Diagram	1
Absolute Maximum Ratings	3
Package Information	3
8 TDFN	3
Electrical Characteristics ($V_{DD} = 5V$)	4
Typical Operating Characteristics	6
Pin Configuration	9
MAX49921	9
Pin Description	9
Detailed Description	10
Applications Information	11
Recommended Component Values	11
Choosing the Sense Resistor	11
Voltage Loss	11
Accuracy	11
Efficiency and Power Dissipation	11
Stray Inductance	11
Important Considerations	11
Power-Supply Bypassing	11
Typical Application Circuits	12
Solenoid Current Measurement	12
DC Motor Current Measurement	12
Ordering Information	13
Revision History	14

Absolute Maximum Ratings

RS+ and RS- to GND	-42V to +80V	Operating Temperature Range	-40°C to +125°C
RS+ to RS-	±2V	Junction Temperature	+150°C
V _{DD} to GND	-0.3V to +6V	Storage Temperature Range	-65°C to +150°C
Continuous Power Dissipation (multilayer board) (T _A = +70°C, derate 16.7mW/°C above +70°C)	1333.3mW	Lead Temperature (soldering, 10s)	+300°C
		Soldering Temperature (reflow)	+260°C

Stresses beyond those listed under "Absolute Maximum Ratings" may cause permanent damage to the device. These are stress ratings only, and functional operation of the device at these or any other conditions beyond those indicated in the operational sections of the specifications is not implied. Exposure to absolute maximum rating conditions for extended periods may affect device reliability.

Package Information

8 TDFN

Package Code	T823Y+3C
Outline Number	21-100417
Land Pattern Number	90-0091
Thermal Resistance, Four-Layer Board:	
Junction to Ambient (θ_{JA})	60°C/W
Junction to Case (θ_{JC})	11°C/W

For the latest package outline information and land patterns (footprints), go to www.maximintegrated.com/packages. Note that a "+", "#", or "-" in the package code indicates RoHS status only. Package drawings may show a different suffix character, but the drawing pertains to the package regardless of RoHS status.

Package thermal resistances were obtained using the method described in JEDEC specification JESD51-7, using a four-layer board. For detailed information on package thermal considerations, refer to www.maximintegrated.com/thermal-tutorial.

Electrical Characteristics ($V_{DD} = 5V$)

($V_{RS+} = V_{RS-} = +50V$, $V_{DD} = +5V$, $V_{SENSE} = V_{RS+} - V_{RS-} = 1mV$, $T_A = -40^{\circ}C$ to $+125^{\circ}C$, unless otherwise noted. Typical values are at $T_A = +25^{\circ}C$. ([Note 1](#)))

PARAMETER	SYMBOL	CONDITIONS	MIN	TYP	MAX	UNITS
POWER-SUPPLY CHARACTERISTICS						
Supply Voltage	V_{DD}	Guaranteed by PSRR	2.7		5.5	V
Supply Current	I_{DD}	No loads		0.7	1	mA
Power-Up Time (Note 2)	t_{PWR_UP}	Output settles to 1%		200		μs
CURRENT-SENSE AMPLIFIER / DC CHARACTERISTICS						
Input-Protected Common-Mode Range	V_{CM_P}	(Note 3)	-42		+80	V
Input Common-Mode Range	V_{CM}	Guaranteed by CMRR	0		+70	V
Input Bias Current	I_{RS+}, I_{RS-}	(Note 3)			0.1	μA
Input Offset Current	$I_{RS+} - I_{RS-}$	(Note 3)			0.1	μA
Input Leakage Current	I_{RS+}, I_{RS-}	$V_{DD} = 0V$, $V_{RS\pm} = 70V$ (Note 3)			0.1	μA
Input Offset Voltage	V_{OS}	G = 20V/V	$T_A = +25^{\circ}C$	± 0.5	± 30	μV
			$-40^{\circ}C \leq T_A \leq +85^{\circ}C$		± 50	
			$-40^{\circ}C \leq T_A \leq +125^{\circ}C$		± 60	
		G = 50V/V	$T_A = +25^{\circ}C$	± 0.5	± 12	
			$-40^{\circ}C \leq T_A \leq +85^{\circ}C$		± 20	
			$-40^{\circ}C \leq T_A \leq +125^{\circ}C$		± 50	
Input Offset Voltage Drift	TCV_{OS}			380	$nV/^{\circ}C$	
Power-Supply Rejection Ratio	PSRR	$2.7V \leq V_{DD} \leq 5.5V$	108			dB
Common-Mode Rejection Ratio	CMRR	$0 \leq V_{CM} \leq +70V$	$-40^{\circ}C \leq T_A \leq +85^{\circ}C$	130	140	dB
			$-40^{\circ}C \leq T_A \leq +125^{\circ}C$	125	140	
Input Capacitance	C_{IN}	RS+, RS- input		3		pF
Input Sense Voltage	V_{SENSE}	G = 20V/V (MAX49921T)		100		mV
		G = 50V/V (MAX49921F)		90		
Gain	G	Full-scale (FS) $V_{SENSE} = 100mV$ (MAX49921T)		20		V/V
		FS $V_{SENSE} = 90mV$ (MAX49921F)		50		
Gain Error (Note 4)	GE	$T_A = +25^{\circ}C$		± 0.05	± 0.1	%
		$-40^{\circ}C \leq T_A \leq +85^{\circ}C$			± 0.15	
		$-40^{\circ}C \leq T_A \leq +125^{\circ}C$			± 0.2	
Nonlinearity Error		$10mV \leq V_{SENSE} \leq 95mV$		0.1		%
Output Resistance	R_{OUT}	$V_{OUT} = V_{DD}/2$, $I_{OUT} = \pm 500\mu A$		0.2		Ω
Output Voltage Swing High	V_{OH}	Source $500\mu A$	$V_{DD} - 0.015$			V

Electrical Characteristics ($V_{DD} = 5V$) (continued)

($V_{RS+} = V_{RS-} = +50V$, $V_{DD} = +5V$, $V_{SENSE} = V_{RS+} - V_{RS-} = 1mV$, $T_A = -40^{\circ}C$ to $+125^{\circ}C$, unless otherwise noted. Typical values are at $T_A = +25^{\circ}C$. (*Note 1*))

PARAMETER	SYMBOL	CONDITIONS	MIN	TYP	MAX	UNITS
Output Voltage Swing Low	V_{OL}	Sink $500\mu A$			15	mV
		No load			4	
Output Short-Circuit Current	I_{SC}	Shorted to either V_{DD} or GND		55		mA
CURRENT-SENSE AMPLIFIER / AC CHARACTERISTICS						
Signal Bandwidth	BW_{-3dB}	All gain configurations $V_{SENSE} > 5mV$		65		kHz
Output Slew Rate	SR	$2V_{P-P}$ output square wave, centered at 1.5V		0.25		V/ μs
AC Power-Supply Rejection Ratio	AC PSRR	$f = 200kHz$		35		dB
AC Common-Mode Rejection Ratio	AC CMRR	$f = 200kHz$, 100mV sine wave		58		dB
Capacitive Load Stability	C_{LOAD}	With 250Ω isolation resistor		20		nF
		Without any isolation resistor		200		pF
Input Voltage Noise Density	e_n	At 1kHz		75		nV/\sqrt{Hz}
Settling Time (Settling to 0.1%)	t_S	V_{SENSE} steps from 20% FS to 80% FS ($t_R = t_F = 5\mu s$), $C_L = 20pF$		20		μs

Note 1: All devices are 100% production tested at $T_A = +25^{\circ}C$. Limits over the operating temperature range and relevant supply voltage range are guaranteed by design and characterization.

Note 2: Output is high-Z during power-up.

Note 3: Guaranteed by design, not final production tested.

Note 4: Gain and offset voltage are calculated based on two point measurements: V_{SENSE1} and V_{SENSE2} . $V_{SENSE1} = 5mV$ and $V_{SENSE2} = 40mV$ for $G = 50V/V$. $V_{SENSE1} = 10mV$ and $V_{SENSE2} = 100mV$ for $G = 20V/V$.

Typical Operating Characteristics

($V_{DD} = 5V$, $V_{CM} = 50V$, $V_{SENSE} = V_{RS+} - V_{RS-} = 1mV$, $T_A = +25^{\circ}C$, unless otherwise noted.)

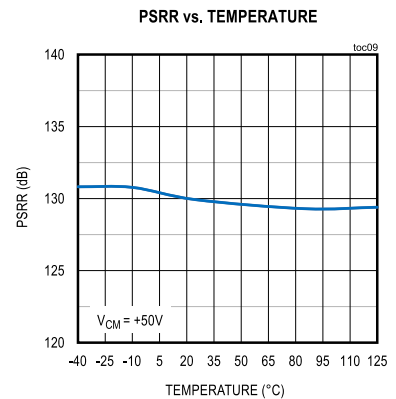
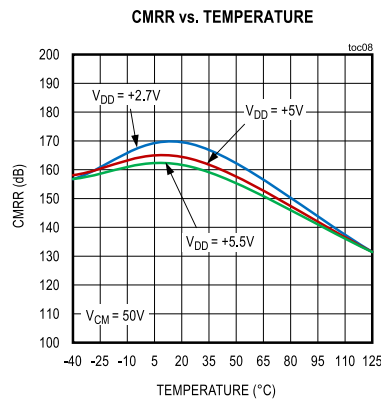
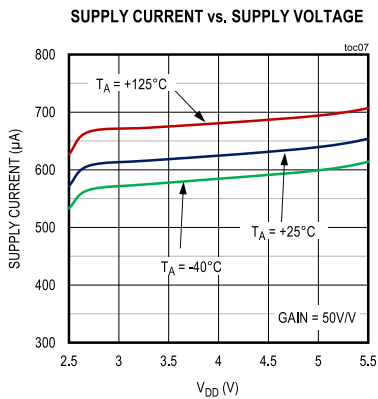
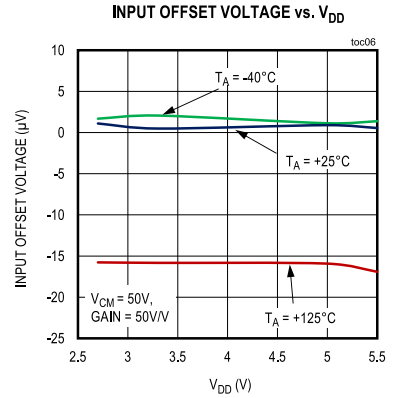
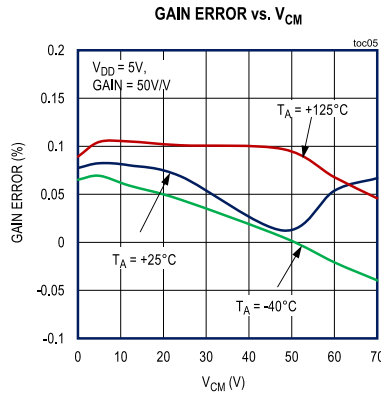
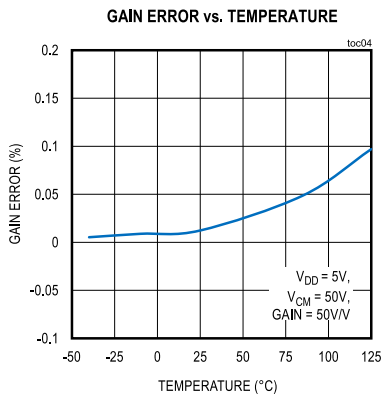
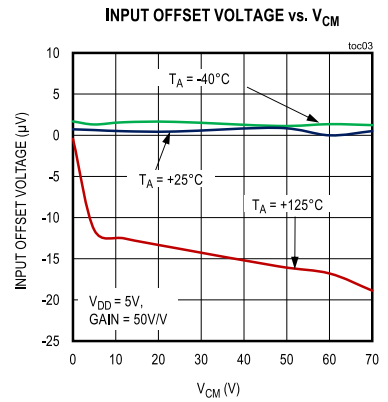
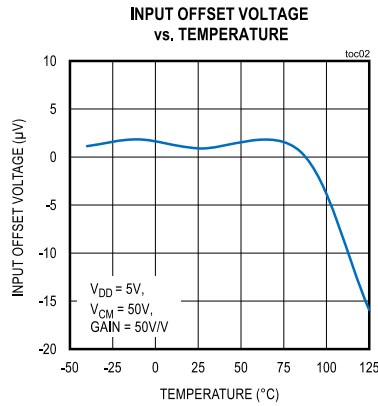
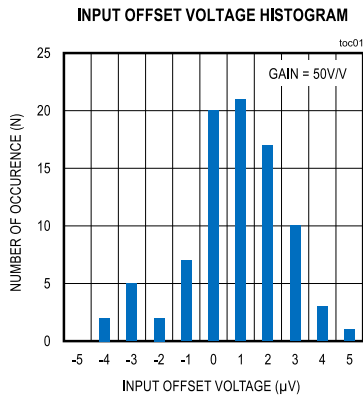

Typical Operating Characteristics (continued)

($V_{DD} = 5V$, $V_{CM} = 50V$, $V_{SENSE} = V_{RS+} - V_{RS-} = 1mV$, $T_A = +25^{\circ}C$, unless otherwise noted.)

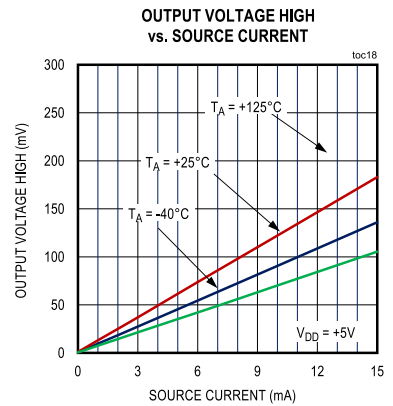
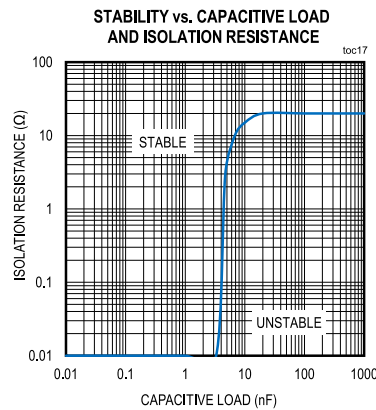
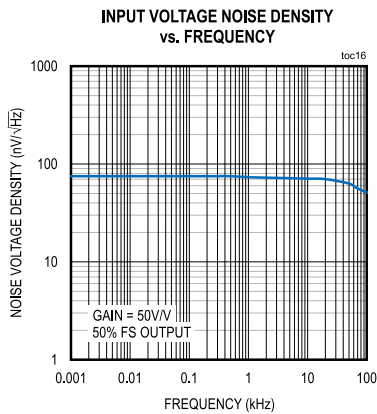
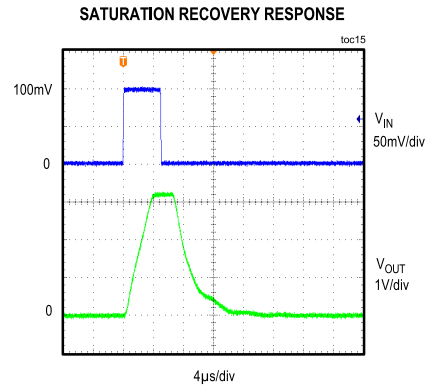
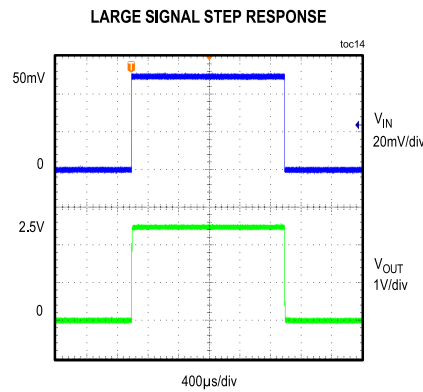
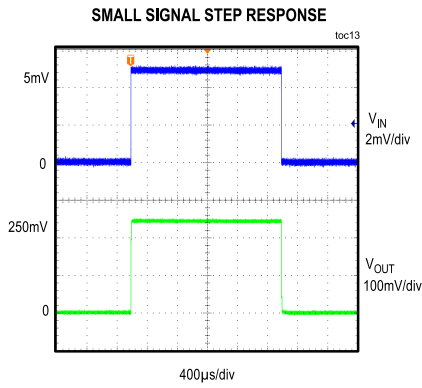
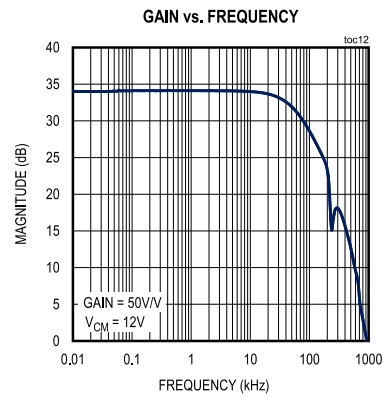
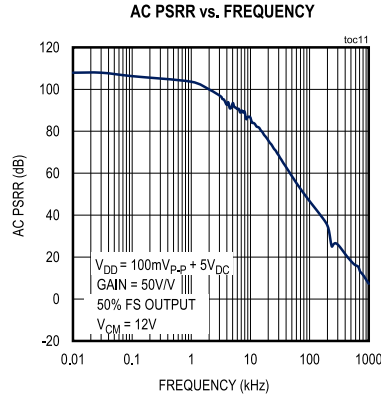
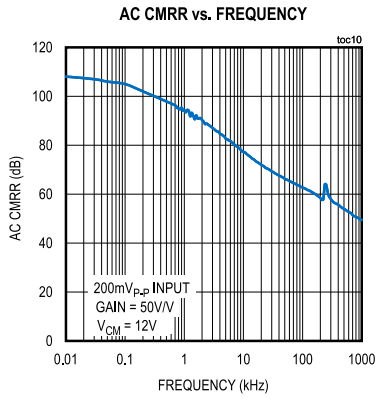

Typical Operating Characteristics (continued)

($V_{DD} = 5V$, $V_{CM} = 50V$, $V_{SENSE} = V_{RS+} - V_{RS-} = 1mV$, $T_A = +25^{\circ}C$, unless otherwise noted.)

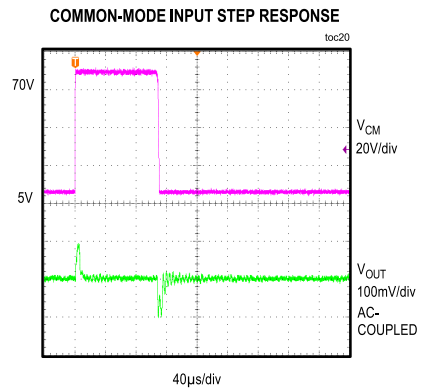
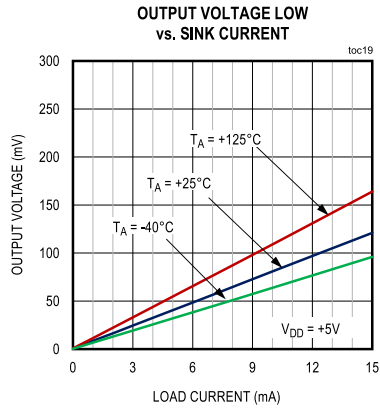

Pin Configuration

MAX49921

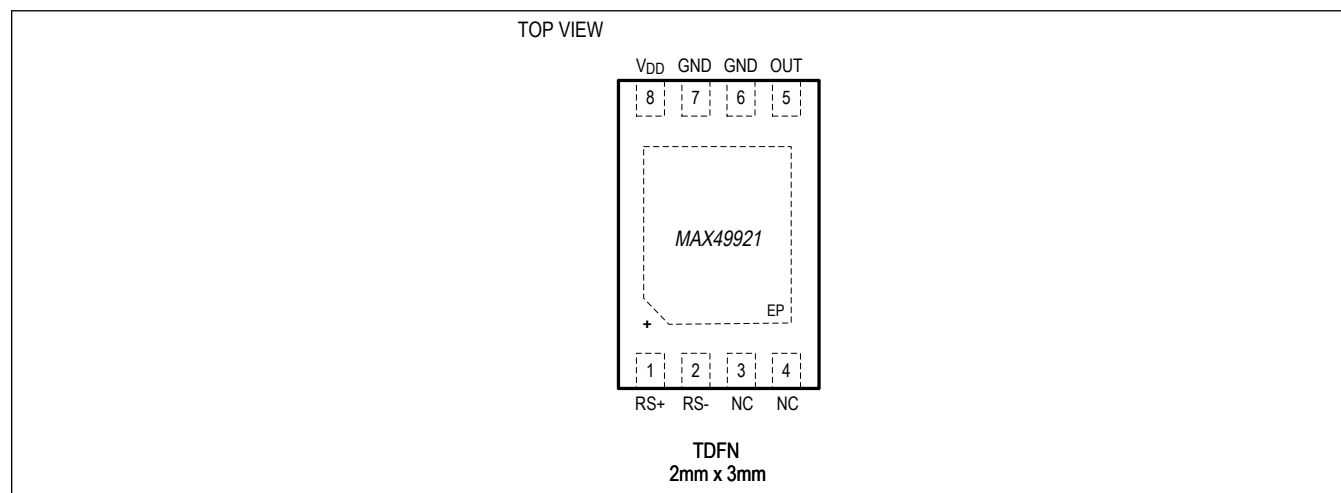

Pin Description

PIN	NAME	FUNCTION
1	RS+	Positive Current-Sensing Input. Power side connects to external sense resistor.
2	RS-	Negative Current-Sensing Input. Load side connects to external sense resistor.
5	OUT	Current-Sense Voltage Output. V_{OUT} is proportional to V_{SENSE} .
6, 7	GND	Ground (connect pins 6 and 7 together at the IC). All ground pins should be connected to a solid ground plane for best performance.
8	V _{DD}	+2.7V to +5.5V Supply Voltage Input. Bypass V _{DD} to GND with a 0.1μF capacitor.
3, 4	NC	No Connection. Not internally connected.
—	EP	Exposed Pad. Internally connected to GND.

Detailed Description

The MAX49921 is a high-precision, current-sense amplifier (CSA) with an operating input common-mode range from 0 to +70V, though the device is protected against input common-mode voltages down to -42V and up to +80V, thus providing protection against reverse-battery and high-voltage spikes. The CSA is well-suited for current monitoring of inductive loads such as DC motors and solenoids, where common-mode voltages can become negative due to inductive kickback, reverse-battery conditions, or transient events.

The low input offset of $\pm 0.5\mu\text{V}$ (typ) and low gain error of $\pm 0.05\%$ (typ) make the device best-suited for high-precision current measurements. The MAX49921 runs from a single supply voltage of +2.7V to +5.5V, consumes 0.7mA (typ) quiescent supply current, and features gains of 20V/V and 50V/V.

The MAX49921 is designed for unidirectional operation, allowing current measurements in one direction through the sense resistor R_{SENSE} . The device output voltage can be estimated as follows:

$$V_{\text{OUT}} = V_{\text{SENSE}} \times A_V$$

where $V_{\text{SENSE}} = (V_{\text{RS}+} - V_{\text{RS}-})$ = the sense voltage across the R_{SENSE} resistor, 100mV for gain of 20V/V, 90mV for gain of 50V/V, and A_V is the gain of the device.

Applications Information

Recommended Component Values

Ideally, the maximum load current develops the full-scale sense voltage across the current-sense resistor. Choose the gain needed to yield the maximum output voltage required for the application using the following equation:

$$V_{OUT} = V_{FS} \times A_V$$

where V_{FS} is the full-scale sense voltage, 100mV for gain of 20V/V, 90mV for gain of 50V/V, and A_V is the gain of the device.

The MAX49921 senses a wide variety of currents with different sense-resistor values. In applications monitoring a high current, ensure that R_{SENSE} is able to dissipate its own I^2R loss. If the resistor's power dissipation exceeds the nominal value, its value may drift or it may fail altogether.

Choosing the Sense Resistor

Choose R_{SENSE} based on the following criteria:

Voltage Loss

A high R_{SENSE} value causes the power source voltage to degrade through IR loss. For minimal voltage loss, use the lowest R_{SENSE} value.

Accuracy

A high R_{SENSE} value allows lower currents measured more accurately. This is due to offsets becoming less significant when the sense voltage is larger. For best performance, select R_{SENSE} to provide approximately 100mV (gain of 20V/V), 90mV (gain of 50V/V) of sense voltage for the full-scale current in each application.

Efficiency and Power Dissipation

At high current levels, the I^2R losses in R_{SENSE} can be significant. Consider this when choosing the resistor value and its power dissipation (wattage) rating. In addition, the sense resistor's value might drift if it heats up excessively.

Stray Inductance

The stray inductance due to package parasitics in the current sense resistor should be kept to a minimum. The unwanted voltage error produced by the stray inductance is proportional to the magnitude of the load current. Wire-wound resistors have the highest inductance, while metal film is comparably better. Low-inductance, metal-film resistors are also available. Instead of being spiral wrapped around a core, as in metal-film or wire-wound resistors, they are straight bands of metal and are available in values under 100mΩ.

Important Considerations

Due to the high currents that may flow through R_{SENSE} , be sure to eliminate solder and parasitic trace resistance to keep from causing errors in the sense voltage. Either use a four-terminal current sense resistor or use Kelvin (force and sense) PCB layout techniques.

Power-Supply Bypassing

Power-supply bypass capacitors are recommended for best performance and should be placed as close as possible to the supply V_{DD} and ground terminals of the device. A typical value for this supply bypass capacitor is 0.1μF (NP0/C0G type) close to the V_{DD}/GND pins. The capacitors should be rated for at least twice the maximum expected applied voltage. Applications with noisy or high-impedance power supplies may require additional decoupling capacitors to reject power-supply noise.

Typical Application Circuits

Solenoid Current Measurement

A solenoid is used to convert electrical energy into a mechanical movement to position an object like a car window. The following figure shows the example circuit that uses the MAX49921 to measure the current in the solenoid with a low-side shunt-sensing resistor. Even if the power supply is connected in reverse, the MAX49921 can still withstand up to -42V without needing a reverse-protection diode.

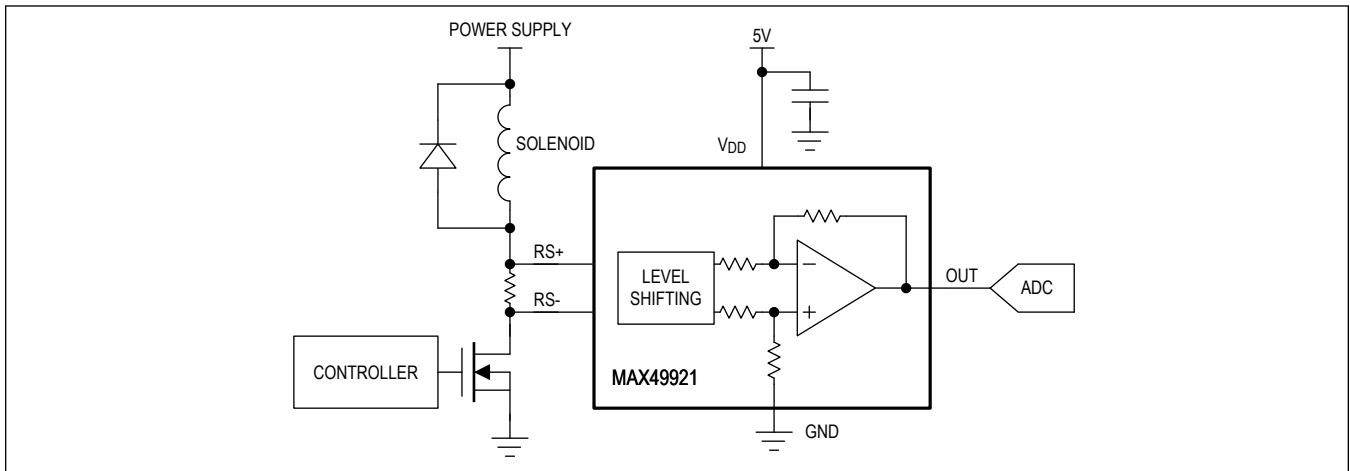

DC Motor Current Measurement

The following figure shows an example of high-side current sensing in a DC motor with the MAX49921. The high common-mode voltage range of the MAX49921 makes it capable of surviving the kick-back voltages in motor switching. The device is also protected up to -42V in case a reverse-battery connection occurs.

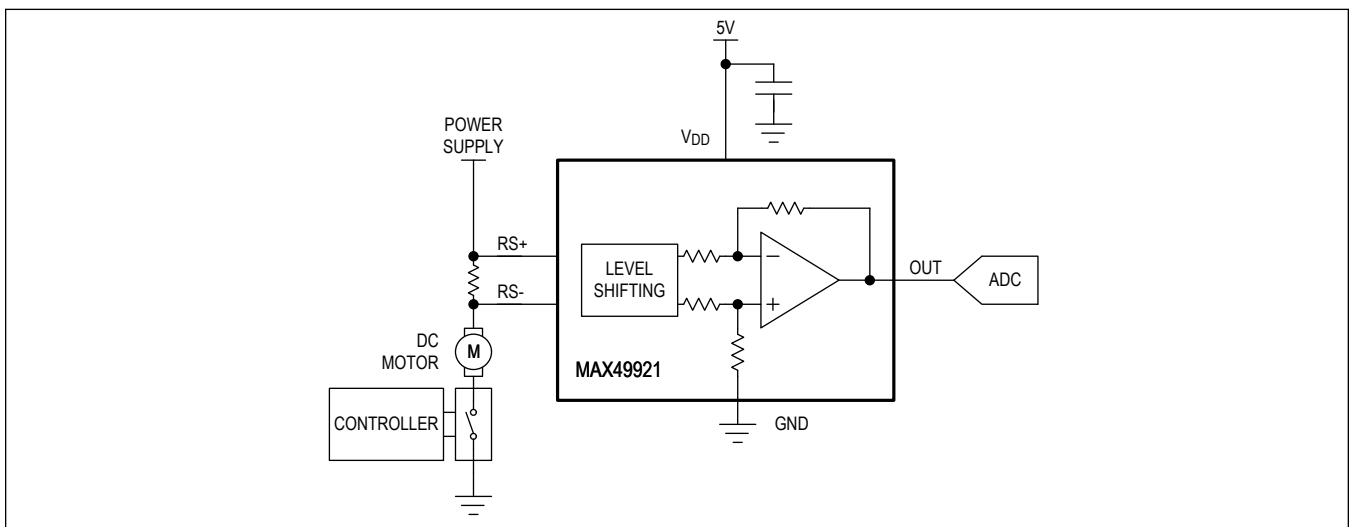

Ordering Information

PART NUMBER	TEMP RANGE	PIN-PACKAGE	TOP MARK	GAIN
MAX49921TATA/VY+	-40°C to +125°C	8 TDFN	BRR	20V/V
MAX49921TATA/VY+T	-40°C to +125°C	8 TDFN	BRR	20V/V
MAX49921FATA/VY+	-40°C to +125°C	8 TDFN	BRQ	50V/V
MAX49921FATA/VY+T	-40°C to +125°C	8 TDFN	BRQ	50V/V

+ Denotes a lead(Pb)-free/RoHS-compliant package.

/V denotes an automotive qualified part.

Revision History

REVISION NUMBER	REVISION DATE	DESCRIPTION	PAGES CHANGED
0	10/20	Release for intro	—
1	9/21	Updated <i>Electrical Characteristics</i> and <i>Ordering Information</i> tables	4, 5, 13