

MAX17672CEVKIT# Evaluation Kit

Evaluates: MAX17672 5V Buck Output Voltage and 1.8V Linear Regulator Output Voltage

General Description

The MAX17672CEVKIT# evaluation kit (EV kit) is a fully assembled and tested circuit board that demonstrates the performance of the MAX17672C dual-output regulator integrating a high-efficiency, high voltage, adjustable output voltage, synchronous step-down DC-DC converter, and a high-PSRR, low-noise, fixed-output linear regulator. The EV kit is designed for a balanced size and efficiency solution and generates a 5V step-down converter output voltage and a fixed 1.8V linear regulator output voltage at load currents up to 150mA and 50mA, respectively. When the linear regulator output is loaded, the step-down converter output current is reduced by I_{LDO} , where I_{LDO} is the load current on the linear regulator output in mA. The EV kit draws only 120 μ A supply current under no-load conditions. The step-down converter is programmed to a switching frequency of 600kHz and delivers a peak efficiency of 90.2% with the supplied components. The dual-output device is simple to use and easily configurable with minimal external components. The EV kit features adjustable input undervoltage lockout, open-drain \overline{RESET} signal, hysteretic peak current-limit protection and external clock synchronization. The EV kit also provides a good layout example, which is optimized for conducted and radiated EMI. For more details about the IC benefits and features, refer to the MAX17672 IC data sheet

Features

- 6.5V to 60V Input-Voltage Range for the Step-Down Converter
- 5V Step-Down Converter Output Voltage, Up To 150mA Continuous Load Current
- 1.8V Linear Regulator Output Voltage, Up To 50mA Continuous Load Current
- Peak Efficiency of 90.2% for the Step-Down Converter
- 120 μ A No-Load Supply Current
- 600kHz Switching Frequency
- Internal Soft-Start
- EN/UVLO Input, Resistor-Programmable UVLO Threshold
- MODE/SYNC Pin to Select PWM or PFM Mode
- Open-Drain \overline{RESET} Output to Monitor Dual Outputs
- External Clock Synchronization
- Overcurrent and Overtemperature Protection
- Proven PCB Layout
- Fully Assembled and Tested
- Complies with CISPR22(EN55022) Class B Conducted and Radiated Emissions

Ordering Information appears at end of data sheet.

MAX17672CEVKIT# Evaluation Kit

Evaluates: MAX17672 5V Buck Output Voltage and 1.8V Linear Regulator Output Voltage

Quick Start

Required Equipment

- MAX17672CEVKIT#
- 6.5V to 60V, 200mA DC-input power supply
- Two loads capable of sinking 150mA and 50mA
- Two digital voltmeters (DVM)

Procedure

The EV kit is fully assembled and tested. Follow the steps below to verify board operation.

Caution: Do not turn on the power supply until all connections are completed.

- 1) Set the power supply at a voltage between 6.5V and 60V. Disable the power supply.
- 2) Connect the positive terminal of the power supply to the VIN PCB pad and the negative terminal to the nearest GND PCB pad. Connect the positive terminal of the 150mA load to the VOUT PCB pad and the negative terminal to the nearest GND PCB pad. Connect the positive terminal of the 50mA load to the OUTL PCB pad and the negative terminal to the nearest GND PCB pad.
- 3) Connect the DVMs across the VOUT PCB pad and the nearest GND PCB pad, and across the OUTL PCB pad and the nearest GND PCB pad.
- 4) Verify that the jumper JU1 is open (see [Table 1](#)).
- 5) Select the shunt position on the jumper JU2 according to the intended mode of operation (see [Table 2](#)).
- 6) Turn on the DC power supply.
- 7) Enable the loads. If linear regulator output is not loaded, step-down converter output can be loaded up to 150mA. Else, it can be loaded up to $(150 - I_{LDO})$ mA, where I_{LDO} is the load current on the linear regulator output in mA.
- 8) Verify that the DVMs display 5V and 1.8V.
- 9) Vary the input voltage from 6.5V to 60V, and vary the load currents on step-down converter and linear regulator outputs, and verify that the output voltages of step-down converter and linear regulator are 5V and 1.8V, respectively.
- 10) Connect the DVM across the $\overline{\text{RESET}}$ pad and GND. Verify that the DVM displays 5V.
- 11) Reduce the input voltage to 5V which is below the EN/UVLO falling threshold.
- 12) Connect the DVM across the VOUT pad and nearest GND. Verify that the DVM displays 0V.
- 13) Connect the DVM across the OUTL pad and nearest GND. Verify that the DVM displays 0V.

- 14) Connect the DVM across the $\overline{\text{RESET}}$ pad and GND. Verify that the DVM displays 0V.
- 15) Disable the input power supply.

Detailed Description

The MAX17672CEVKIT# evaluation kit (EV kit) is a fully assembled and tested circuit board that demonstrates the performance of the MAX17672C dual-output regulators integrating a high-efficiency, high voltage, adjustable output voltage, synchronous step-down DC-DC converter, and a high-PSRR, low-noise, fixed output linear regulator. The step-down converter operates over a wide input range of 6.5V to 60V and the input of the linear regulator is connected to the output of the step-down converter. The EV kit is designed for a balanced size and efficiency solution and generates a 5V step-down converter output voltage and a fixed 1.8V linear regulator output voltage, at load currents up to 150mA and 50mA, respectively. When the linear regulator output is loaded, the step-down converter output current is reduced by I_{LDO} , where I_{LDO} is the load current on the linear regulator output in mA. The EV kit draws only 120 μ A supply current under no-load conditions. The step-down converter is programmed to a switching frequency of 600kHz and delivers a peak efficiency of 90.2% with the supplied components. The dual-output device is simple to use and easily configurable with minimal external components. The EV kit features adjustable-input undervoltage lockout, open-drain $\overline{\text{RESET}}$ signal, hysteresis peak current-limit protection and external frequency synchronization.

This EV kit includes an EN/UVLO PCB pad and JU1 to enable the step-down converter output at a desired input voltage. The MODE/SYNC PCB pad and JU2 are provided for selecting the intended mode of operation and to allow an external clock to synchronize the step-down converter. A $\overline{\text{RESET}}$ PCB pad is available for monitoring the $\overline{\text{RESET}}$ output.

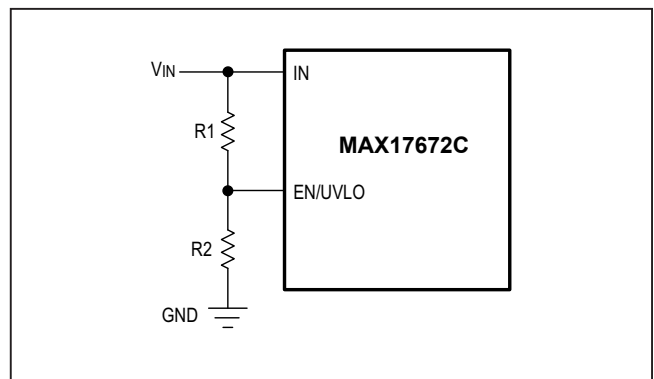

Figure 1. Setting the Input-Undervoltage Lockout

Enable/Undervoltage-Lockout (EN/UVLO) Programming

The MAX17672C offers an Enable and adjustable input undervoltage lockout feature. In this EV kit, for normal operation, leave the EN/UVLO jumper (JU1) open. When JU1 is left open, the MAX17672C is enabled when the input voltage rises above 6.4V. To disable the MAX17672C, install a jumper across pins 1-2 on JU1. See Table 1 for JU1 settings. The EN/UVLO PCB pad on the EV kit supports external Enable/Disable control of the device. Leave jumper JU1 open when external Enable/Disable control is desired. A potential divider formed by R1 and R2 sets the input voltage (V_{INU}) above which the converter is enabled when JU1 is left open.

Choose R1 to be 3.32MΩ (max), and then calculate R2 as follows:

$$R2 = \frac{R1 \times 1.215}{(V_{INU} - 1.215)}$$

where V_{INU} is the voltage at which the device is required to turn on, and R1 and R2 are in kΩ. The allowed minimum value of V_{INU} is 4V. For more details about setting the undervoltage lockout level, refer to the MAX17672 data sheet.

Mode Selection (MODE/SYNC)

The EV kit provides a jumper (JU2) that allows the MAX17672C to operate in PWM and PFM modes. Refer to the MAX17672 data sheet for more details on the modes of operation. Table 2 shows the mode selection jumper (JU2) settings that can be used to configure the desired mode of operation.

External Clock Synchronization (MODE/SYNC)

The EV kit provides a MODE/SYNC PCB pad to synchronize the MAX17672C to an optional external clock. Leave jumper (JU2) open when external clock signals are applied. In the presence of a valid external clock for synchronization, the MAX17672C operates in PWM mode only. For more details about external clock synchronization, refer to the MAX17672 data sheet.

Table 1. Step-Down Converter Enable (EN/UVLO) Jumper (JU1) Settings

SHUNT POSITION	EN/UVLO PIN	OUTPUT
Not installed*	Connected to the center node of resistor-divider R1 and R2	Enabled, UVLO level set through the R1 and R2 resistors
1-2	Connected to GND	Disabled

*Default position.

Active-Low, Open-Drain Reset Output ($\overline{\text{RESET}}$)

The EV kit provides a $\overline{\text{RESET}}$ PCB pad to monitor the status of the step-down converter output voltage and the linear regulator output voltage. $\overline{\text{RESET}}$ goes high 2.1ms after both step-down converter and linear regulator outputs rise above 95% of their nominal set value if V_{INL} is above V_{INL_UVLO} (2.18V typ) during startup. Otherwise, $\overline{\text{RESET}}$ only considers step-down converter output voltage for its high-impedance state. $\overline{\text{RESET}}$ goes low when one of the either output voltages fall below 92% (typ) of their nominal regulated voltage.

Hot Plug-In and Long Input Cables

The MAX17672CEVKIT# PCB layout provides an optional electrolytic capacitor (C5 = 22μF/100V). This capacitor limits the peak voltage at the input of the MAX17672C when the DC input source is “Hot-Plugged” to the EV kit input terminals with long input cables. The equivalent series resistance (ESR) of the electrolytic capacitor dampens the oscillations caused by interaction of the inductance of the long input cables, and the ceramic capacitors at the step-down converter input.

Electromagnetic Interference (EMI)

Compliance to conducted emissions (CE) standards requires an EMI filter at the input of a switching power converter. The EMI filter attenuates high-frequency currents drawn by the switching power converter and limits the noise injected back into the input power source.

The MAX17672CEVKIT# PCB has designated footprints for the placement of conducted EMI filter components. Use of these filter components results in lower conducted emissions below CISPR22 Class B limits. Cut open the trace at L2 before installing conducted EMI filter components. The MAX17672CEVKIT# PCB layout is also designed to limit radiated emissions from switching nodes of the power converter, resulting in radiated emissions below CISPR22 Class B limits.

Table 2. MODE Selection (MODE/SYNC) Jumper (JU2) Settings

SHUNT POSITION	MODE/SYNC PIN	MODE
1-2	Connected to GND	PWM Mode of operation
Not installed*	Unconnected	PFM Mode of operation

*Default position.

MAX17672CEVKIT# Performance Report

($V_{IN} = 24V$, unless otherwise noted.)

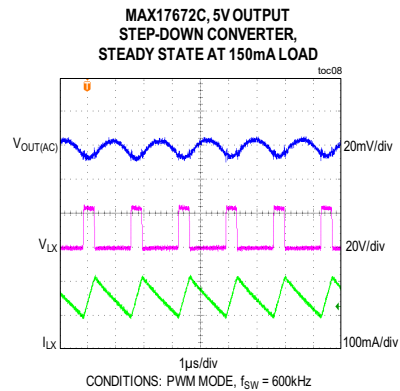
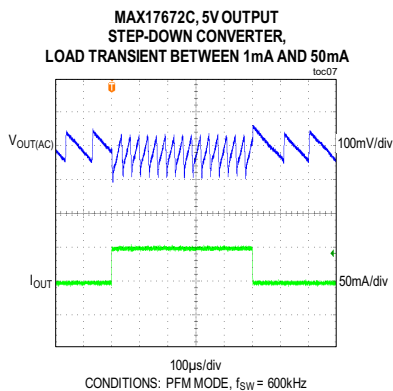
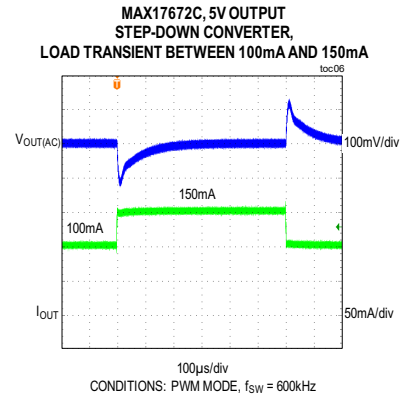
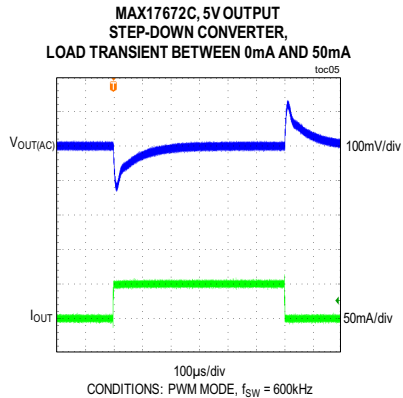
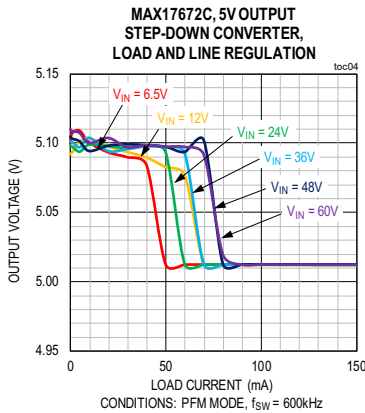
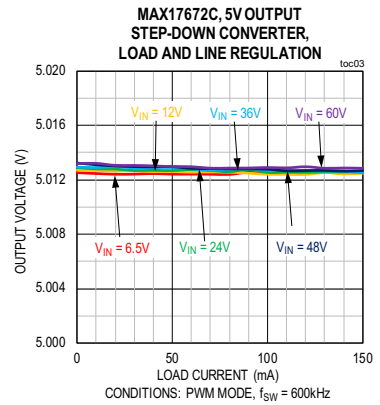
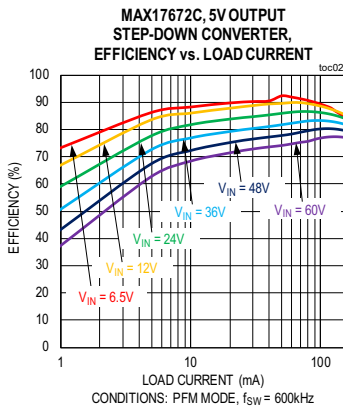
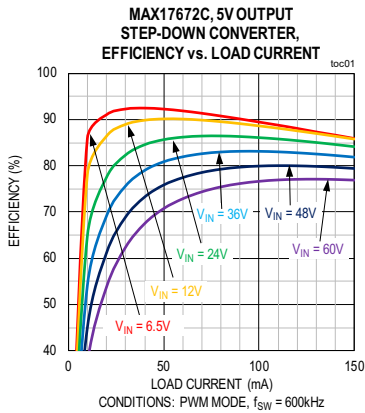

MAX17672CEVKIT# Performance Report (continued)

($V_{IN} = 24V$, unless otherwise noted.)

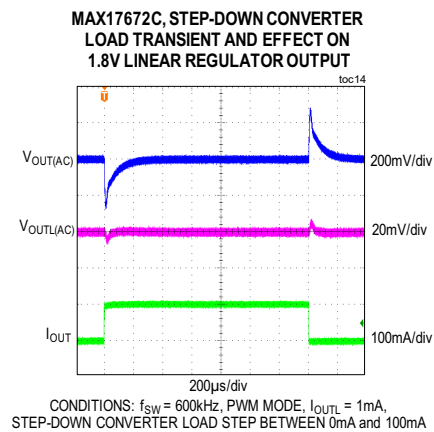
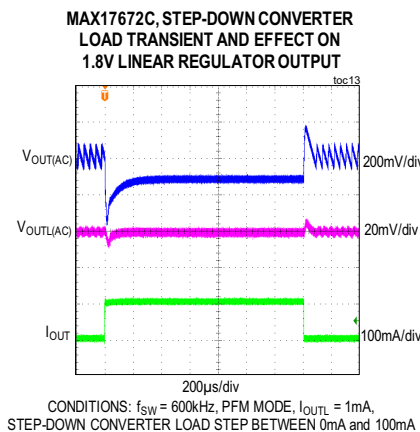
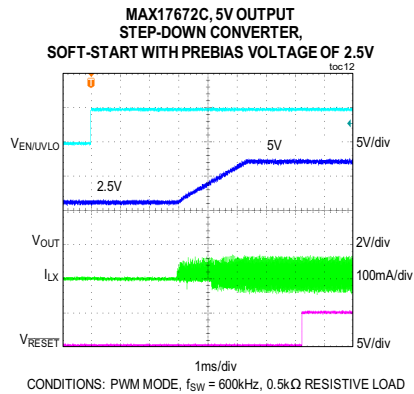
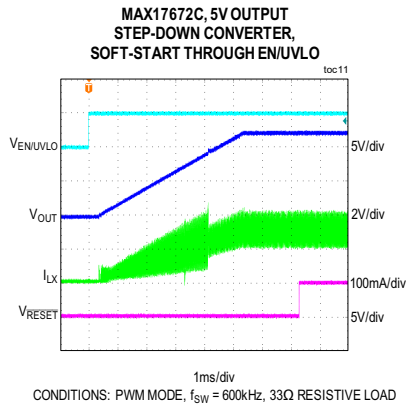
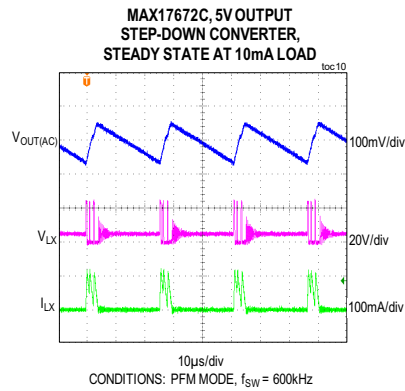
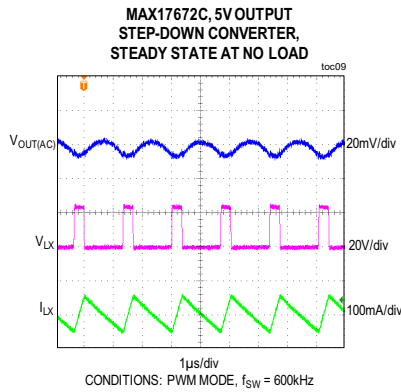

MAX17672CEVKIT# Evaluation Kit

Evaluates: MAX17672
5V Buck Output Voltage and
1.8V Linear Regulator Output Voltage

MAX17672C EV Kit Performance Report (continued)

($V_{IN} = 24V$, unless otherwise noted.)

MAX17672C, 1.8V OUTPUT
LINEAR REGULATOR,
LOAD TRANSIENT BETWEEN 1mA AND 25mA

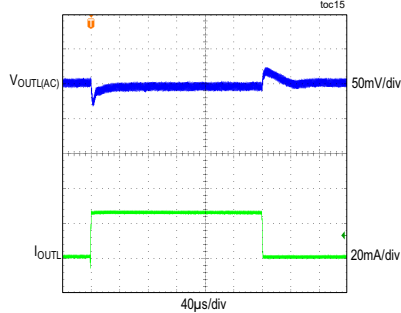

CONDITIONS: INL CONNECTED TO V_{OUT} , PWM MODE

MAX17672C, 1.8V OUTPUT
LINEAR REGULATOR,
LOAD TRANSIENT BETWEEN 25mA AND 50mA

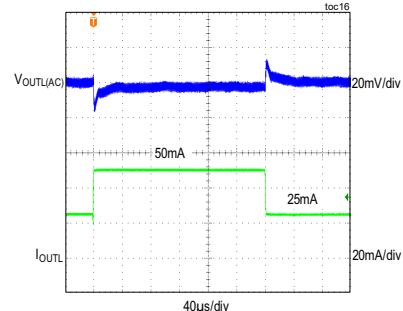

CONDITIONS: INL CONNECTED TO V_{OUT} , PWM MODE

MAX17672C, 1.8V OUTPUT
LINEAR REGULATOR,
STARTUP FROM EN/UVLO

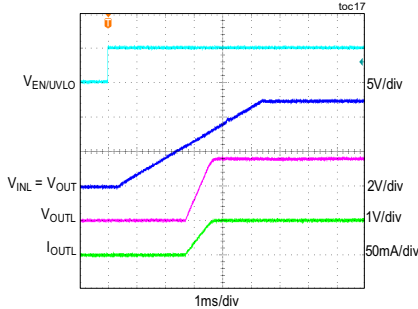

CONDITIONS: $f_{SW} = 600kHz$, 36Ω RESISTIVE LOAD ON LINEAR REGULATOR, INL CONNECTED TO V_{OUT}

MAX17672C, 1.8V OUTPUT LINEAR REGULATOR,
OUTPUT VOLTAGE vs. INPUT VOLTAGE

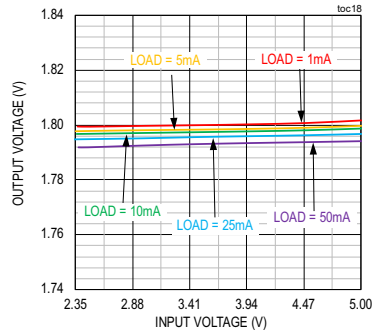

CONDITIONS: INL CONNECTED TO EXTERNAL SUPPLY

MAX17672C, 5V OUTPUT
STEP-DOWN CONVERTER,
CLOSED LOOP BODE PLOT

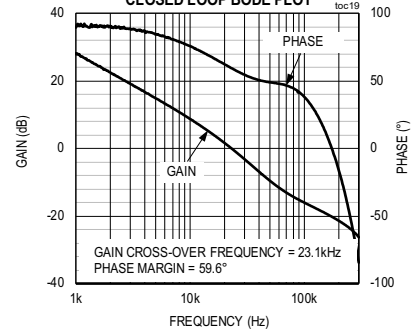

CONDITIONS: PWM MODE, $f_{SW} = 600kHz$, 33Ω RESISTIVE LOAD

MAX17672C, 1.8V OUTPUT LINEAR REGULATOR,
POWER SUPPLY REJECTION RATIO vs. FREQUENCY

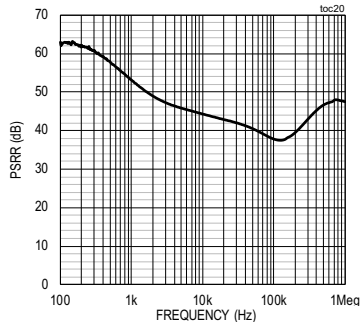

CONDITIONS: LOAD = 50mA, INL CONNECTED TO EXTERNAL SUPPLY, $V_{INL} = 2.8V$

MAX17672C CONDUCTED EMISSIONS PLOT
5V OUTPUT, 150mA LOAD CURRENT

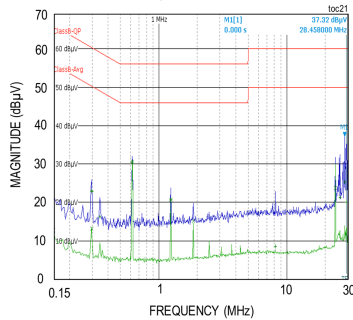

$L2 = 8.2µH$, $C10 = 1µF/100V/X7R/1206$

MAX17672C RADIATED EMISSIONS PLOT
5V OUTPUT, 150mA LOAD CURRENT

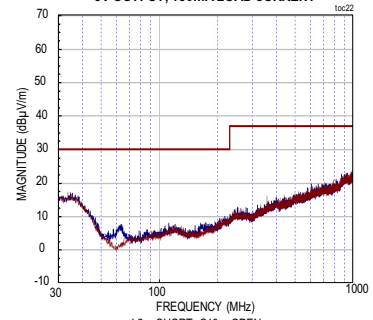

$L2 = \text{SHORT}$, $C10 = \text{OPEN}$

MAX17672CEVKIT# Evaluation Kit

Evaluates: MAX17672
5V Buck Output Voltage and
1.8V Linear Regulator Output Voltage

Component Suppliers

SUPPLIER	WEBSITE
Coilcraft, Inc.	www.coilcraft.com
Murata Americas	www.murataamericas.com
Panasonic Corp.	www.panasonic.com
Vishay	www.vishay.com
TDK	www.tdk.com
Taiyo Yuden	www.yuden.co.jp/eu/

Note: Indicate that you are using the MAX17672 when contacting these component suppliers.

Ordering Information

PART	TYPE
MAX17672CEVKIT#	EVKIT

MAX17672CEVKIT# Evaluation Kit

Evaluates: MAX17672
5V Buck Output Voltage and
1.8V Linear Regulator Output Voltage

MAX17672C EV System Bill of Materials

No.	Designator	Description	Quantity	Manufacturer Part Number
1	C1	1 μ F, 10%, 100V, X7R, Ceramic capacitor (1206)	1	TAIYO YUDEN HMK316B7105KL-T
2	C2	2.2 μ F, 10%, 10V, X7R, Ceramic capacitor (0603)	1	MURATA GRM188R71A225KE15
3	C4	4.7 μ F, 10%, 16V, X7R, Ceramic capacitor (0603)	1	MURATA GRM188Z71C475KE21
4	C5	22 μ F, 20%, 100V, Electrolytic capacitor	1	PANASONIC EEE-TG2A220UP
5	C7	0.1 μ F, 10%, 16V, X7R, Ceramic capacitor (0402)	1	TAIYO YUDEN EMK105B7104KV-F
6	C9	0.1 μ F, 10%, 100V, X7R, Ceramic capacitor (0603)	1	TAIYO YUDEN HMK107B7104KA-T
7	JU1, JU2	2-pin header (36-pin header 0.1" centers)	2	SULLINS PEC02SAAN
8	L1	INDUCTOR, 68 μ H, 0.29A	1	COILCRAFT LPS3015-683MR
9	R1	3.32M Ω , \pm 1%, 1/16W, resistor (0402)	1	
10	R2	787k Ω , \pm 1%, 1/16W, resistor (0402)	1	
11	R3	261k Ω , \pm 1%, 1/16W, resistor (0402)	1	
12	R4	49.9k Ω , \pm 1%, 1/16W, resistor (0402)	1	
13	R6	10k Ω , \pm 1%, 1/16W, resistor (0402)	1	
14	R7	0 Ω , \pm 5%, 1/16W, resistor (0402)	1	
15	U1	Integrated Step-down Converter with a Linear Regulator, MAX17672C	1	MAXIM MAX17672CATB+
16	C10	OPTIONAL: 1 μ F, 10%, 100V, X7R, Ceramic capacitor (1206)	1	TAIYO YUDEN HMK316B7105KL-T
17	L2	OPTIONAL: INDUCTOR, 8.2 μ H, 2.2A (3mm x 3mm)	1	COILCRAFT LPS3010-822ME

Jumper Table	
Jumper	Shunt Position
JU1, JU2	Open

MAX17672CEVKIT# Evaluation Kit

Evaluates: MAX17672
5V Buck Output Voltage and
1.8V Linear Regulator Output Voltage

MAX17672C EV System Schematic

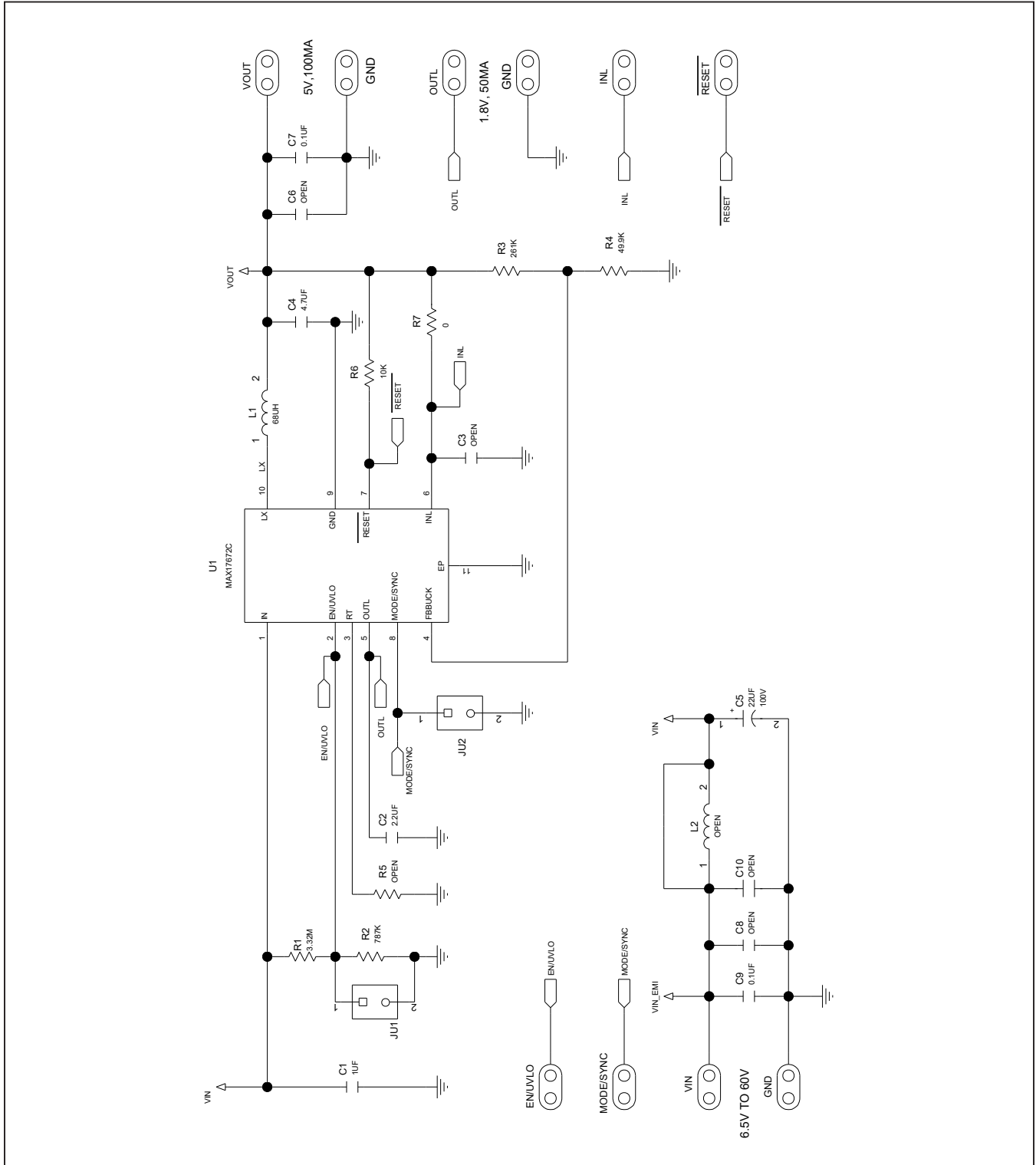

MAX17672CEVKIT# Evaluation Kit

Evaluates: MAX17672
5V Buck Output Voltage and
1.8V Linear Regulator Output Voltage

MAX17672C EV System PCB Layout

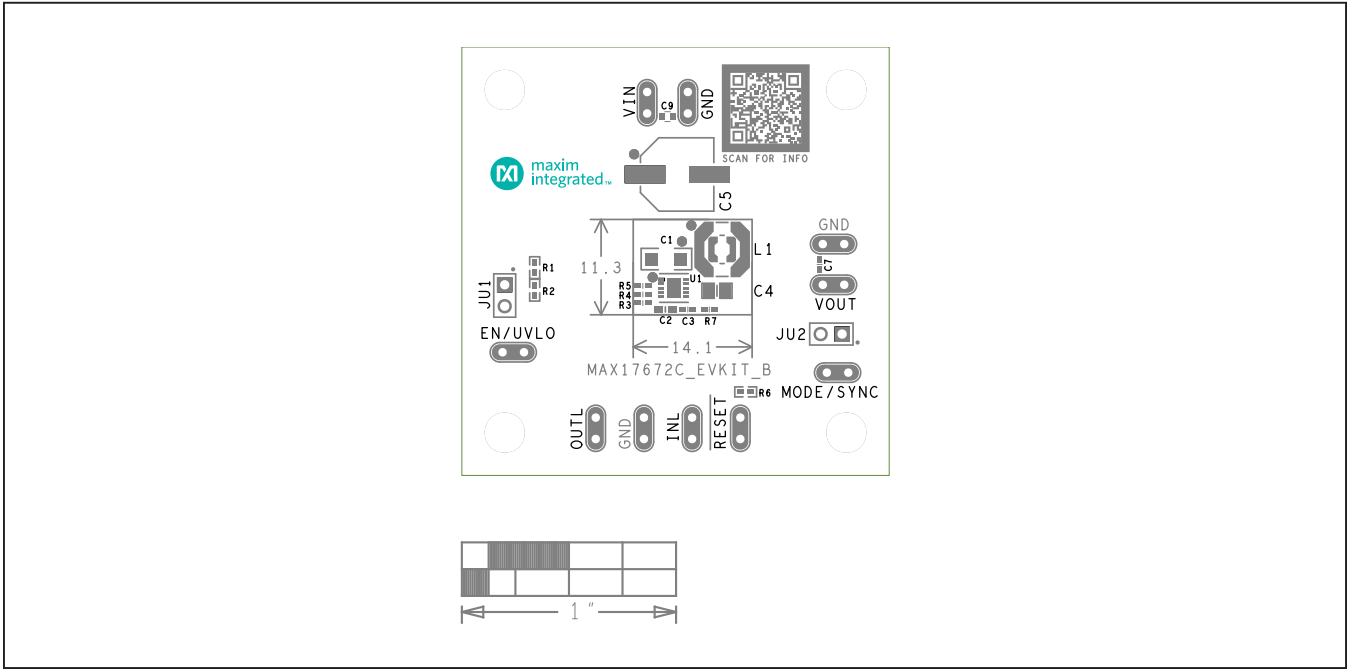

MAX17672C EV Kit—Top Silkscreen

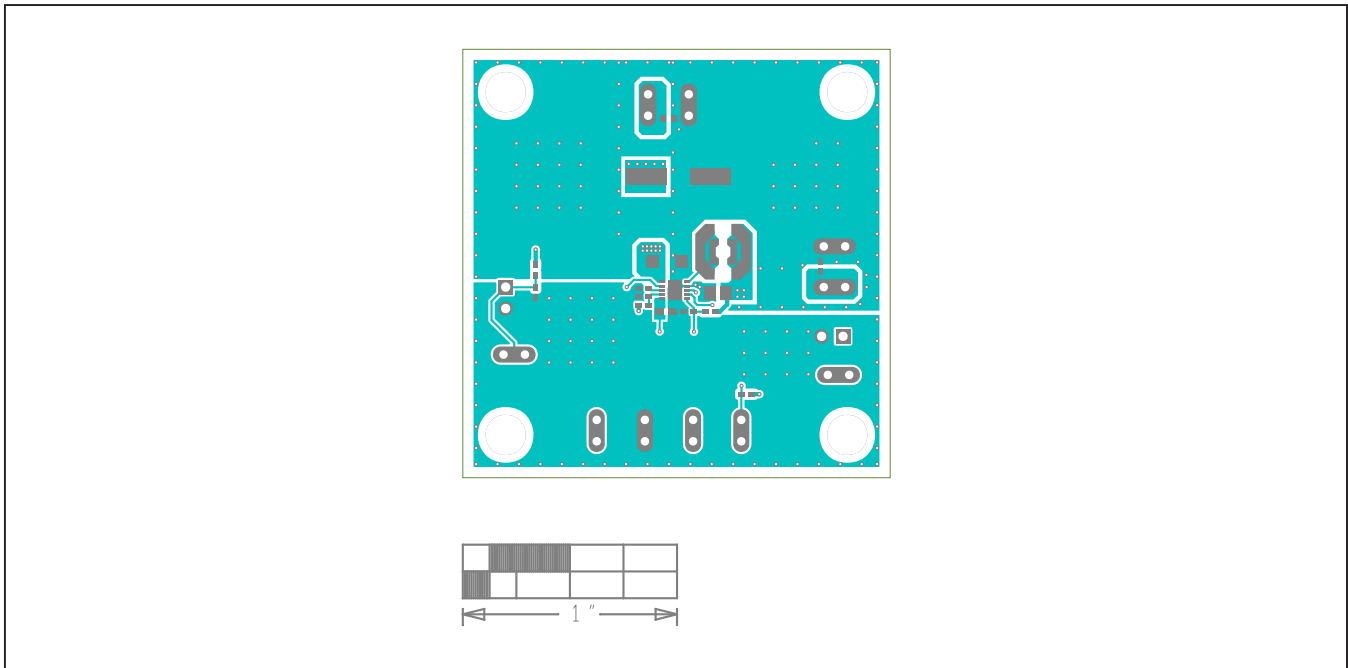

MAX17672C EV Kit—Top Layer

MAX17672CEVKIT# Evaluation Kit

Evaluates: MAX17672
5V Buck Output Voltage and
1.8V Linear Regulator Output Voltage

MAX17672C EV System PCB Layout (continued)

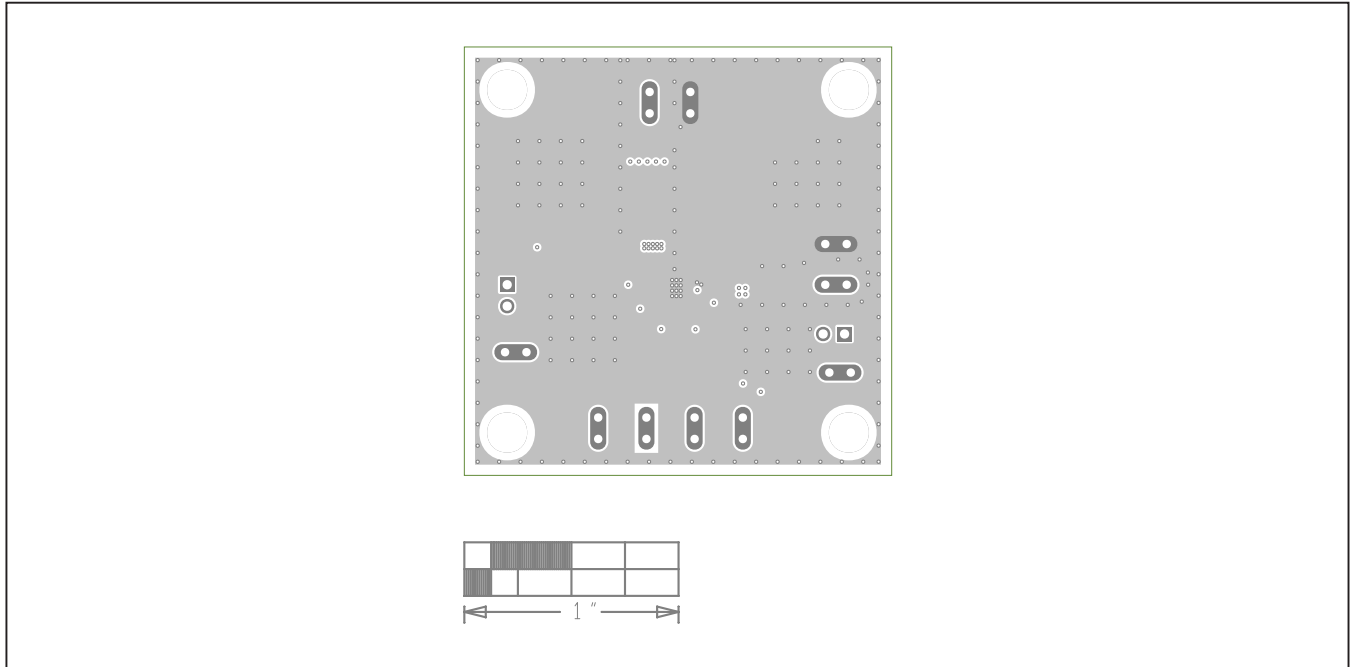

MAX17672C EV Kit—Layer 2

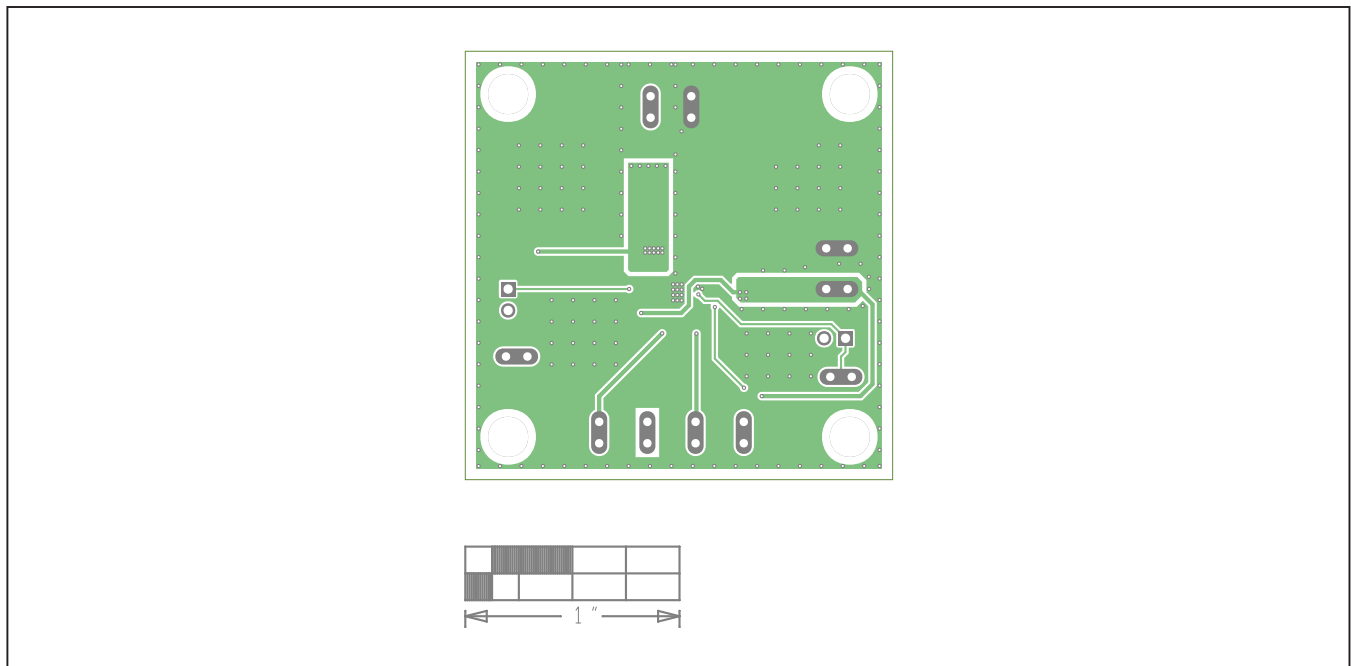

MAX17672C EV Kit—Layer 3

MAX17672C EV System PCB Layout (continued)

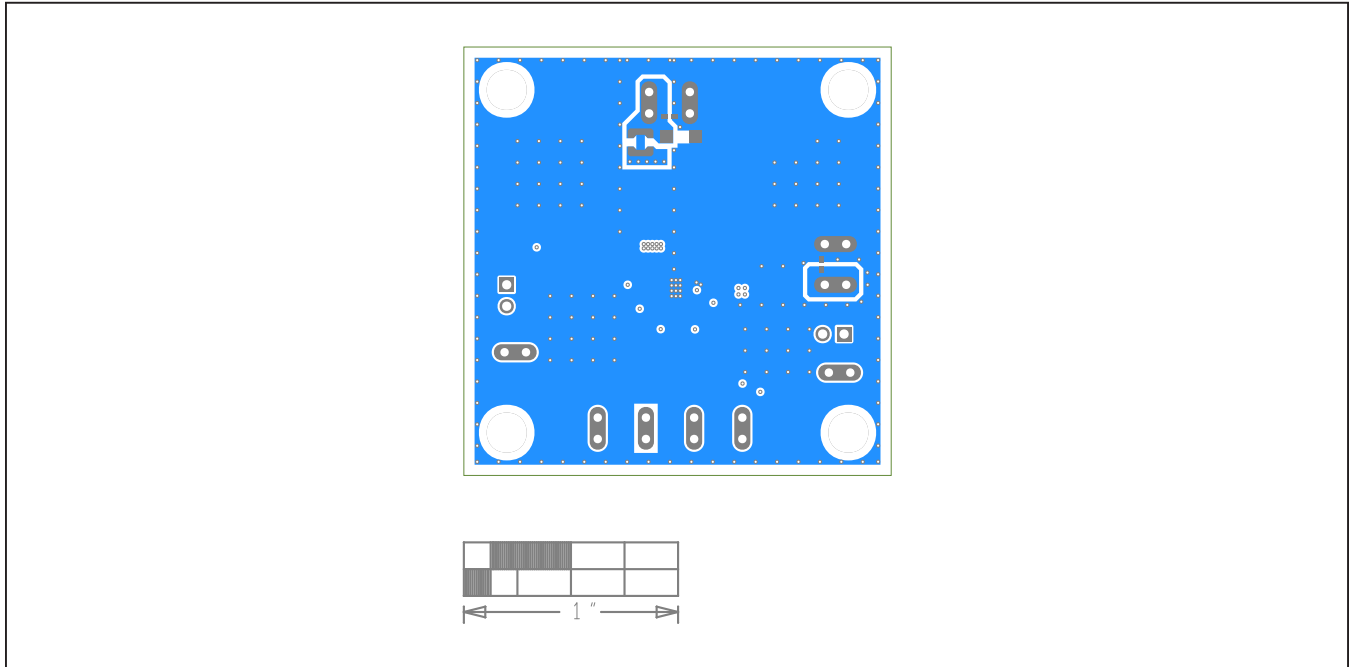

MAX17672C EV Kit—Bottom Layer

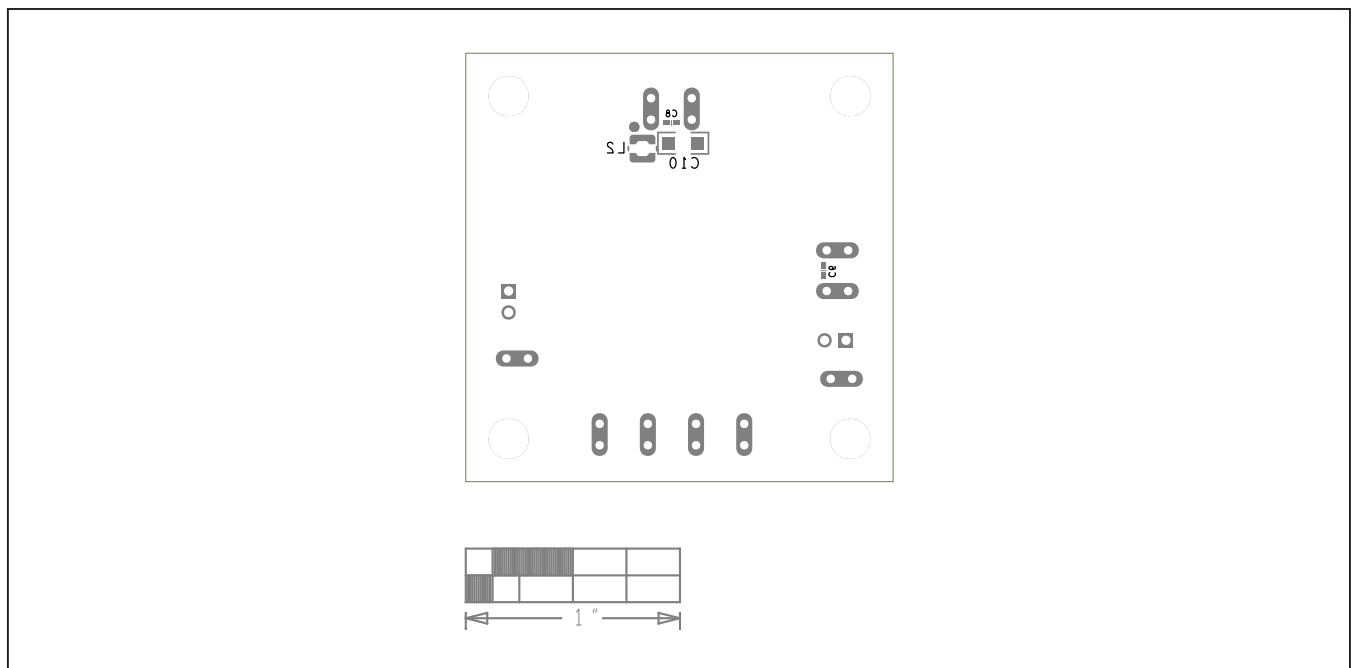

MAX17672C EV Kit—Bottom Silkscreen

MAX17672CEVKIT# Evaluation Kit

Evaluates: MAX17672
5V Buck Output Voltage and
1.8V Linear Regulator Output Voltage

Revision History

REVISION NUMBER	REVISION DATE	DESCRIPTION	PAGES CHANGED
0	12/18	Initial release	—
1	7/19	Updated all sections	1-12

For pricing, delivery, and ordering information, please visit Maxim Integrated's online storefront at <https://www.maximintegrated.com/en/storefront/storefront.html>.

Maxim Integrated cannot assume responsibility for use of any circuitry other than circuitry entirely embodied in a Maxim Integrated product. No circuit patent licenses are implied. Maxim Integrated reserves the right to change the circuitry and specifications without notice at any time.