

MAX17320X/MAX17320G Evaluation Kits

Evaluate: MAX17320

General Description

The MAX17320X/MAX17320G evaluation kits (EV kits) are fully assembled and tested surface-mount PCBs that evaluate the stand-alone pack-side fuel gauge IC with protector and optional SHA-256 authentication for 2-4 cell lithium-ion/polymer batteries.

The MAX17320 EV kits include the IC evaluation board with integrated I²C/1-Wire[®] interface and USB micro-B cable. Windows[®] based graphical user interface (GUI) software is available for use with the EV kit and can be downloaded from <https://www.maximintegrated.com/products/MAX17320.html/> product page under “Design Resources” tab. Windows 7 or newer Windows operating system is required to use with the EV kit GUI software.

Features

- ModelGauge m5 Algorithm
- Monitors Multicell Packs
- Full Protection Solution On-Board for Evaluation
- Battery Pack Input Voltage Range of +2.3V to +4.9V/ Cell with Default Hardware
- Default Current Range -10A to +10A with 5mΩ Sense Resistor, Higher Currents Can Be Supported by Changing to a Smaller Sense Resistor
- Thermistor Measurement
- On-Board I²C/1-Wire Communication Interface with Built-In MAXUSB Interface
- Windows 7 or Newer Compatible Software
- Proven PCB Layout
- Fully Assembled and Tested

Ordering Information appears at end of data sheet.

MAX17320 Evaluation EV Kit Files

FILE	DESCRIPTION
MAX17320EVKitGUISetup.msi	Installs all EV kit files on a computer

Windows is a registered trademark and registered service mark of Microsoft Corporation.

Maxim Integrated Products, Inc. registered trademark.

Quick Start

Required Equipment

- MAX17320 Evaluation kit
- Lithium-ion/polymer cells
- Battery charger
- Load circuit
- USB cable
- PC with Windows 7 or newer Windows operating system and USB port

Note: In the following sections, software-related items are identified by bolding. Text in **bold** only refers to items directly from the EV kit software. Text in **bold and underlined** refers to items from the Windows OS.

Procedure

The EV kits are fully assembled and tested. Follow the steps below to install the EV kit software, make required hardware connections, and start operation of the kits. The EV kit software can be launched without hardware attached. It automatically locates the hardware when connections are made. Note that after communication is established with the IC, the IC must be configured correctly for the fuel gauge to be accurate.

- 1) Visit <https://www.maximintegrated.com/products/MAX17320.html/> page under Design Resources tab to download the latest version of the MAX17320 EV kit software. Save the EV kit software to a temporary folder and unpack the ZIP file.
- 2) Install the EV kit software on a computer by running the MAX17320EVKitGUISetup.msi program inside the temporary folder. The program files are copied, and icons are created in the Windows **Start** menu. The software requires Windows 7 or newer operating system. .NET version 4.5 is required for operation and is automatically installed if an older version of .NET framework is detected and if the computer is connected to the Internet.
- 3) Follow the prompts to complete the installation. The evaluation software can be uninstalled in the **Add/Remove programs** tool in the **Control Panel**.
- 4) The EV kit software launches automatically after installation or alternatively it can be launched by clicking on its icon in the Windows **Start** menu.



- 5) Make connections to the EV kit board based on pack configuration. [Figure 1](#) shows the connections for a 4S configuration. The cells connect between the BATTN/BATT1/BATT2/BATT3/BATTP pads. [Table 1](#) describes the connections for 2S, 3S, and 4S configurations. The load or charger circuit can be connected between the SYSGND and SYSPWR pads at this time as well.
- 6) Connect the EV kit to a USB port on the PC using the USB cable. Press the S1 button to wake up the MAX17320. The GUI software establishes communication automatically.
- 7) At startup, the IC defaults to the EZ Configuration. If a custom .INI file for the application is available, it should be loaded at this time.

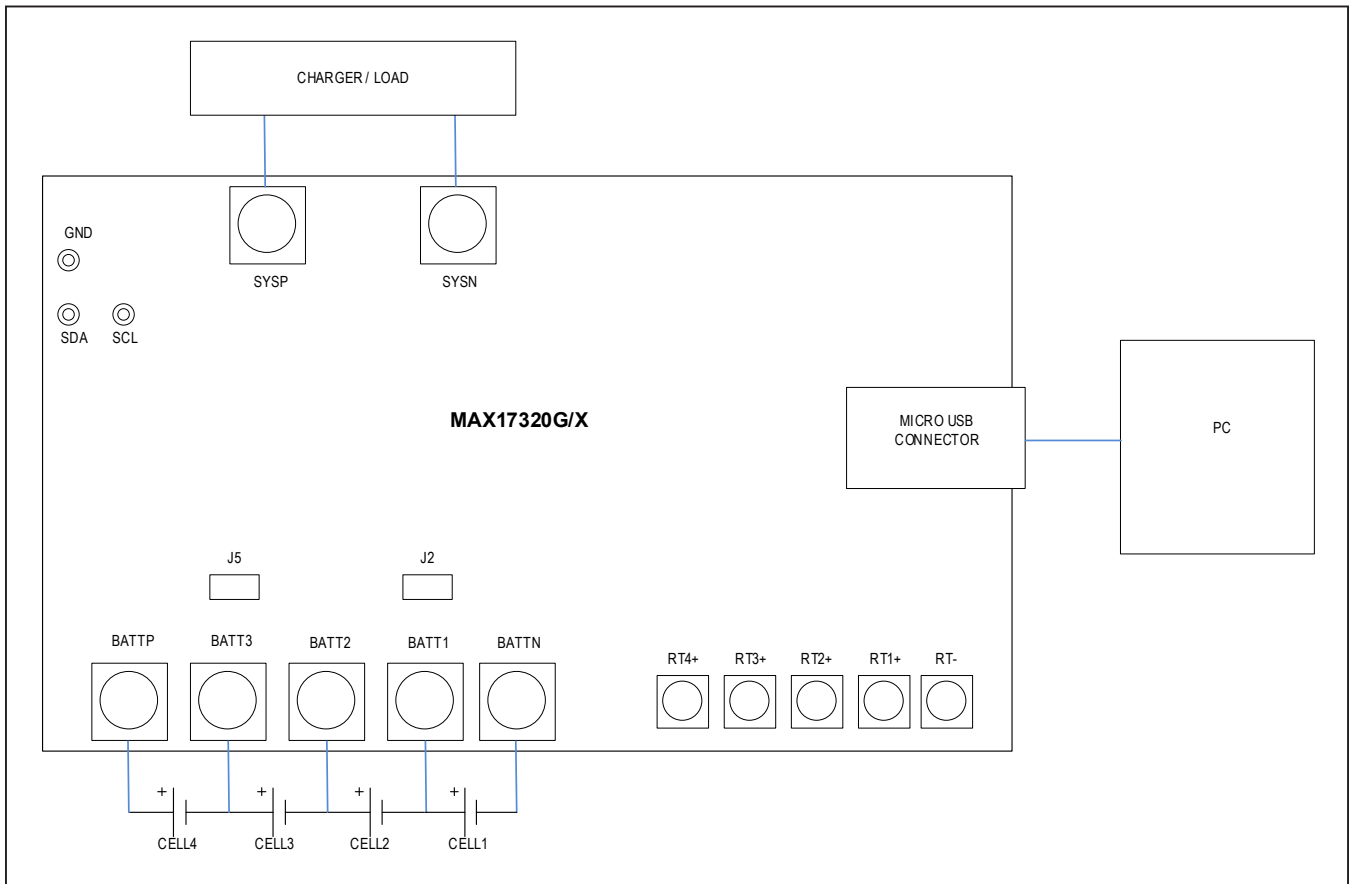

Figure 1. MAX17320 Board Connections

Detailed Description of Hardware

The MAX17320 EV kit board provides a variety of features that highlight the functionality of the IC. The following sections explain the most important aspects of the EV kit board.

Communication Connections

The USB interface on the PCB establishes I²C or 1-Wire[®] communication between the IC and the software GUI interface. When developing application code separately, connections to the communication lines can be made directly to the board SDA (DQ) and SCL (OD) pins. The user must apply the appropriate external pullup resistors to the communication lines when not using the built-in MAXUSB interface.

Number of Cells

The MAX17320 can be configured for use with 2 to 4 series cells. The cell connections and jumper settings for J2 and J5 should be set according to [Table 1](#). CellxN indicates the negative terminal of the cell. CellxP indicates the positive terminal of the cell. The number of cells should be configured in the **Configuration Wizard**.

External Thermistors

The MAX17320 can be configured to use temperature measurements from 1 to 4 external thermistors. All EV kit boards come with 4 thermistors installed as surface mount components RT1-RT4. If the application requires direct thermal contact to the cells, RT1-RT4 can be removed and replaced with a leaded thermistor connected between the RTx+/RT- solder pads. The number of thermistors should be configured in the **Configuration Wizard**.

Sense Resistor Options

All EV kit boards are shipped with a 5mΩ 0805-size chip sense resistor installed. Oversized land pattern pads allow for different size sense resistors to be used if desired.

Detailed Description of Software

The MAX17320G/X evaluation kit software gives the user complete control of all functions of the MAX17320, as well as the ability to load a custom model into the IC. Separate control tabs allow the user access to view real-time updates of all monitored parameters. The software also incorporates a data-logging feature to monitor a cell over time.

After the installation is complete, open the Program Files (x86)\Maxim Integrated\MAX17320 folder and run MAX17320.exe or select it from the program menu. [Figure 2](#) shows a splash screen containing information about the evaluation kit that appears while program is loading.

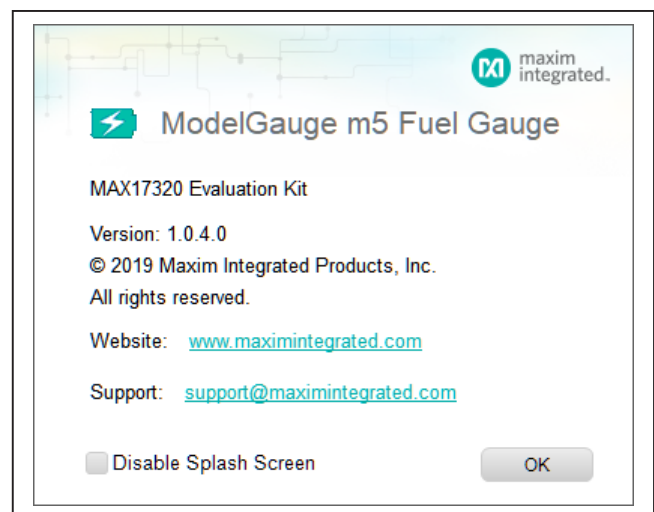

Figure 2. EV Kit Splash Screen

Table 1. Cell and Jumper Configuration

NUMBER OF CELLS	J2	J5	BATTN	BATT1	BATT2	BATT3	BATTP
2	1-2	1-2	Cell1N	Open	Cell1P/Cell2N	Open	Cell2P
3	1-2	Open	Cell1N	Open	Cell1P/Cell2N	Cell2P/Cell3N	Cell3P
4	Open	Open	Cell1N	Cell1P/Cell2N	Cell2P/Cell3N	Cell3P/Cell4N	Cell4P

Communication Port

The EV kit software automatically finds the EV kit when connected to any USB port. Communication status is shown on the right-hand side of the bottom status bar. See [Figure 3](#). If the EV kit cannot be found, a **No USB Adapter** message is displayed. If the EV kit is found, but the IC cannot be found, a **No Slave Device** message is displayed. If the IC is properly powered, pressing the S1 button wakes up the IC. Otherwise, if communication is valid, a green bar updates as the software continuously reads the IC registers.

The bottom status bar also displays information on data logging status, the communication mode, power mode, selected current-sense resistor value, device serial number, and the EV kit GUI's version number.

Program Tabs

All functions of the program are distributed under various tabs in the main program window. Click on the appropriate tab to move to the desired function page.

- Located on the **ModelGauge m5** tab is the primary user information measured and calculated by the IC.
- The **Protector** tab displays all the protection settings of the IC.

- The **Graphs** tab visually displays fuel gauge changes over time.
- The **Registers** tab allows the user to view and modify common fuel gauge registers one at a time.
- The **Commands** tab allows for special operations such as initializing the fuel gauge logging and performing fuel gauge reset.
- The **Configuration** tab allows the user to modify the NVMemory registers one at a time, but any changes here are not written to NVMemory.
- The **Register View** tab allows the user to view the individual bitfields of all registers.
- The **Authentication** tab allows the user to send and verify the SHA commands.
- The **History** tab allows all of the history information to be recalled and viewed from the IC.
- If SBS Mode is enabled on the IC, the SBS tab is displayed to show the **SBS** Memory Map.
- The **I2C Traffic Log** tab maintains a log of any special communication with the IC.

All tabs are described in more detail in the following sections.

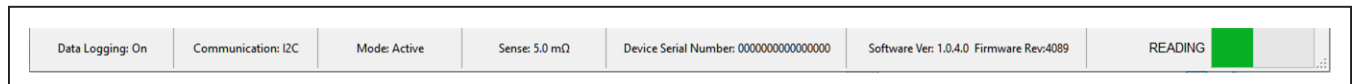

Figure 3. EV Kit Bottom Status Bar

ModelGauge m5 Tab

The **ModelGauge m5** tab in [Figure 4](#) displays the important output information read from the IC. Information is grouped by function and each is detailed separately.

State of Charge

The **State of Charge** group box displays the main output information from the fuel gauge: state of charge of the cell, remaining capacity, time to full, and time to empty.

Cell Information

The **Cell Information** group box displays information related to the health of the cell such as the cell's age, internal resistance, present capacity, number of equivalent full cycles, and change in capacity from when it was new.

Measurements

The **Measurements** group box displays ADC measurements that are used by the fuel gauge to determine state of charge.

Pre-qual / Balancing Status

The **Pre-qual / Balancing Status** group box displays the status of any cell balancing or prequalification charge current modulation that is being controlled by the IC.

Alerts

The **Alerts** group box tracks all possible alert trigger conditions. If any alert occurs, the corresponding LED becomes green for the user to see. The **Clear Alerts** button resets all alert flags.

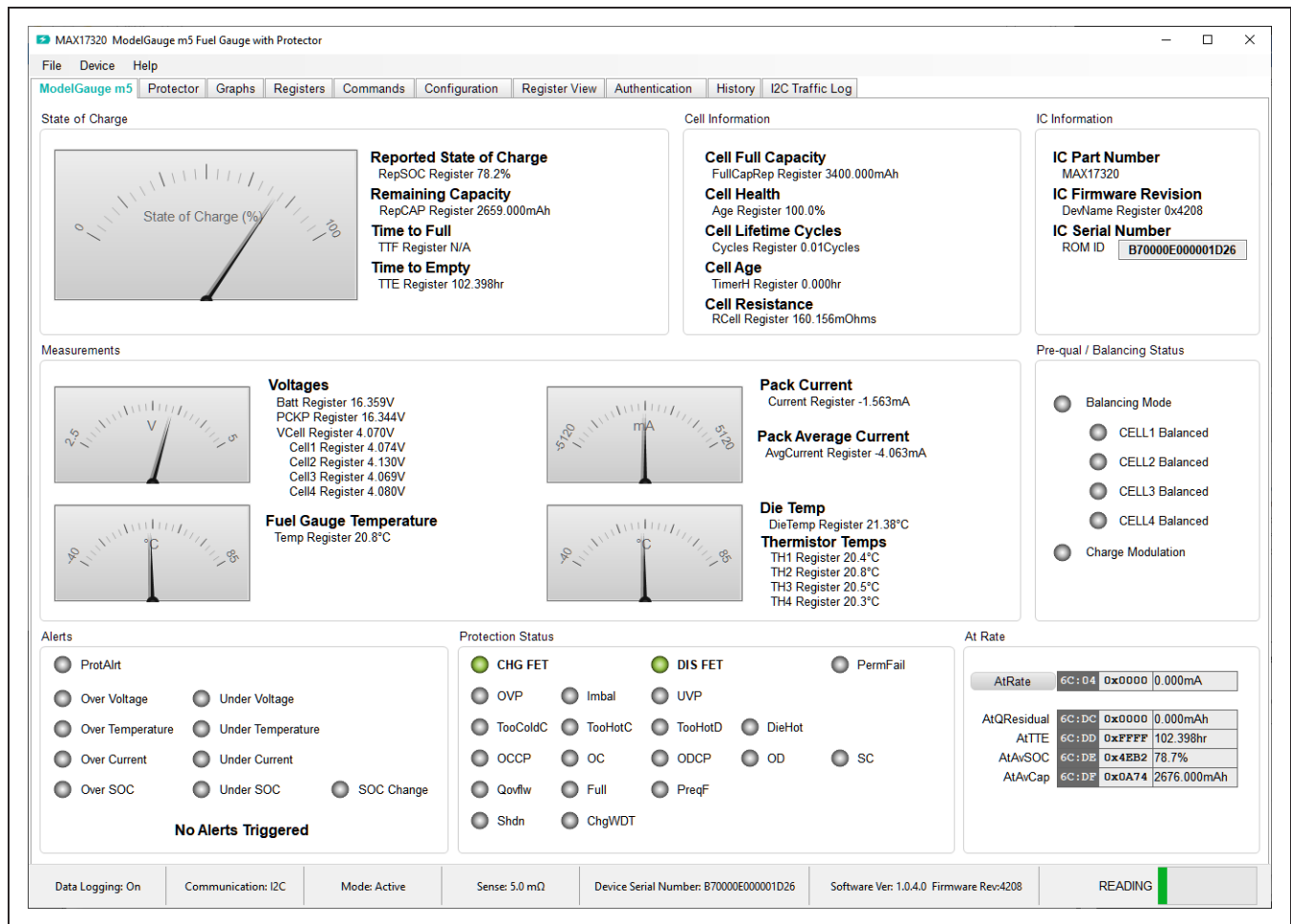

Figure 4. ModelGauge m5 Tab

Protection Status

The **Protection Status** group box displays the status of the charge and discharge FETs as well as all bits of the ProtStatus register. If the FETs LED is green, current can flow. If the LED is red, there is a fault condition and the FET is open, preventing current flow.

At Rate

The **At Rate** group box allows user to input a hypothetical load current (AtRate) and the fuel gauge calculates the corresponding hypothetical **AtQResidual**, **AtTTE**, **AtAvSOC**, and **AtAvCap** values.

Protector Tab

The **Protector** tab in [Figure 5](#) displays the protection settings read from the IC. The settings cannot be changed

from this tab. Use the **Configuration Wizard** to update these settings. Information is grouped by function and each is detailed separately.

The **Measurements**, **Alerts**, and **Protection Status** group boxes display the same information that is shown on the **ModelGauge m5** tab.

Charging Configuration

The **Charging Configuration** group box displays all the protection settings related to charging as well as a graphical view those selections across the programmable temperature ranges.

Discharging Configuration

The **Discharging Configuration** group box displays all the protection settings related to discharging.

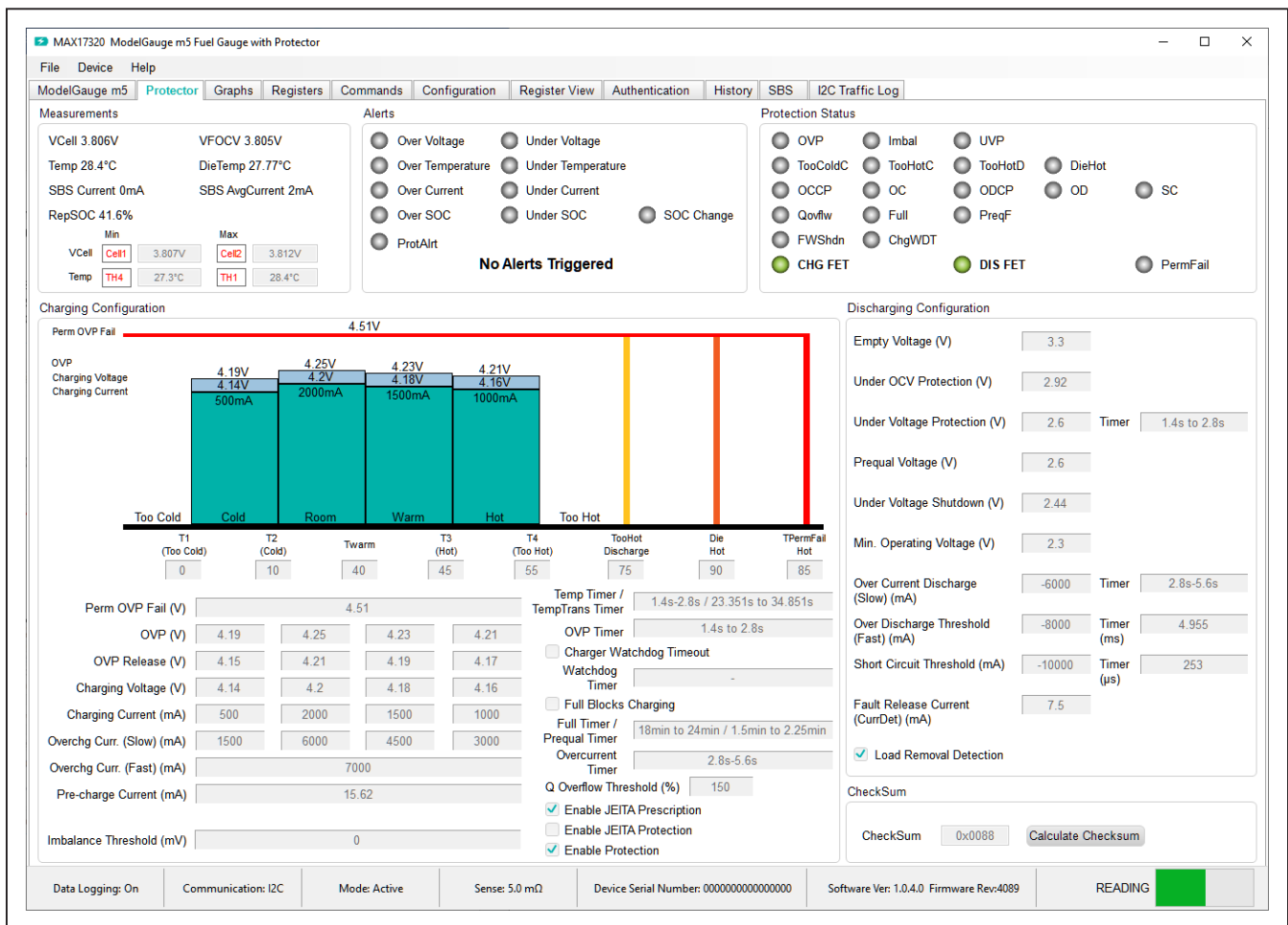

Figure 5. Protector Tab

Graphs Tab

Figure 6 shows the format of the **Graphs** tab. Graph information is grouped into four categories: **Voltages**, **Temperatures**, **Capacities**, and **Currents**. The user can turn on or off any data series using the check boxes on the right-hand side of the tab. The graph visible viewing area can be adjusted from 10 minutes up to 1 week.

The graphs remember up to 1 week worth of data. If the viewing area is smaller than the time range of the data already collected, the scroll bar below the graphs can be used to scroll through graph history. All graph history information is maintained by the program. Graph settings can be changed at any time without losing data. Voltages in the graph are plotted as an average cell voltage measurement.

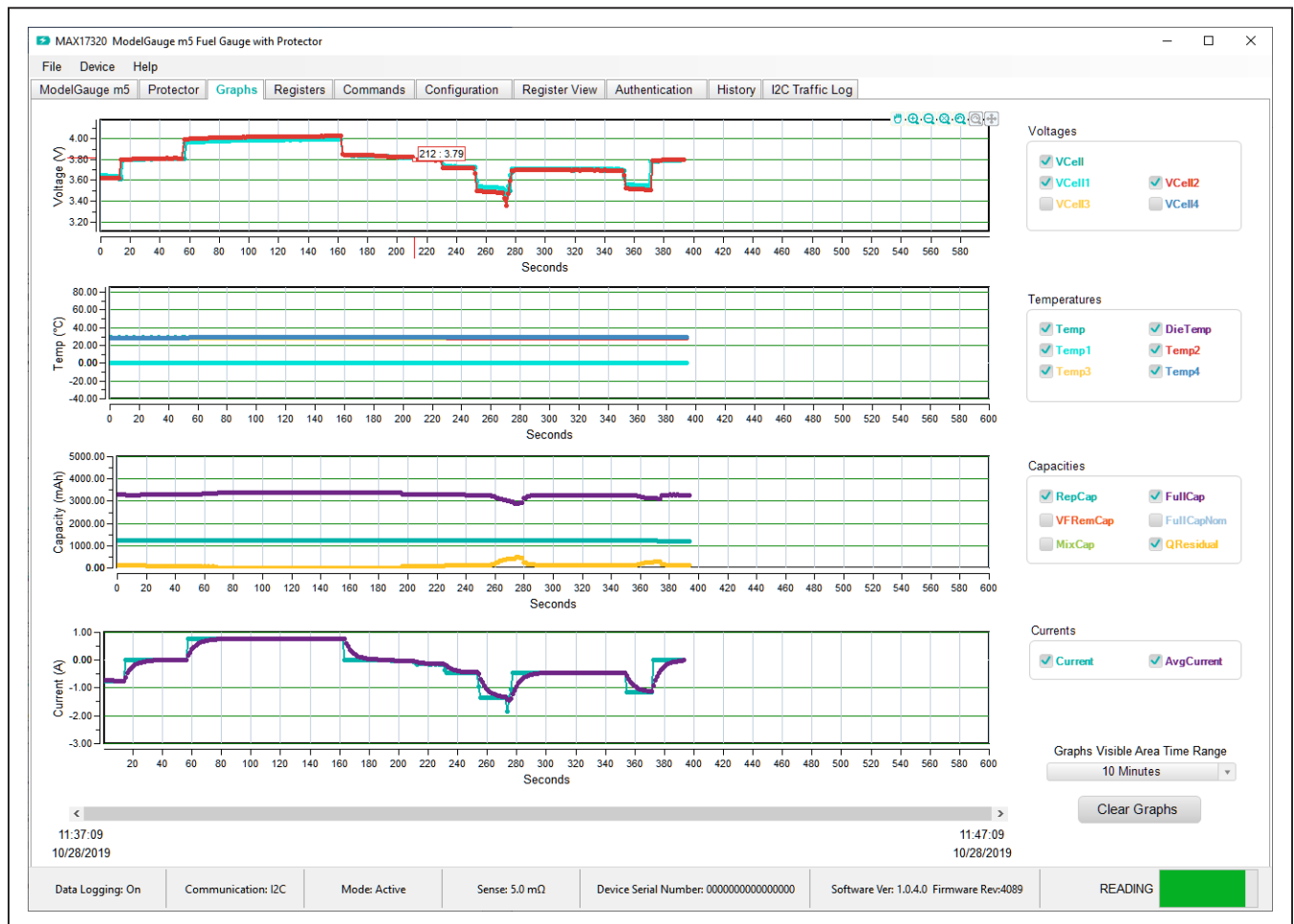

Figure 6. Graphs Tab

Registers Tab

The **Registers** tab in [Figure 7](#) allows the user access to all fuel gauge related registers of the IC. The user can sort the registers either by function or by their internal address by clicking the appropriate button at the top of the tab. Each line of data contains the register name, register address, hexadecimal representation of the data stored in the register, and if applicable a conversion to application units.

The MAX17320 has a Write Protection function that prevents accidental writing of any register. Before writing any register, the Write Protection must be disabled.

The GUI provides a convenient switch at the top of the **Registers** and **Configuration** tabs to lock and unlock the Write Protection. The **Write Protection** status automatically reenables if there is no movement of the mouse for 10 seconds to prevent accidentally leaving the **Write Protection** disabled.

To write a register location, first toggle the **Write Protection** slider to unlocked and then click on the button containing the register name. A pop-up window allows the user to enter a new value in either hexadecimal units or application units. The main read loop temporarily pauses while the register updates.

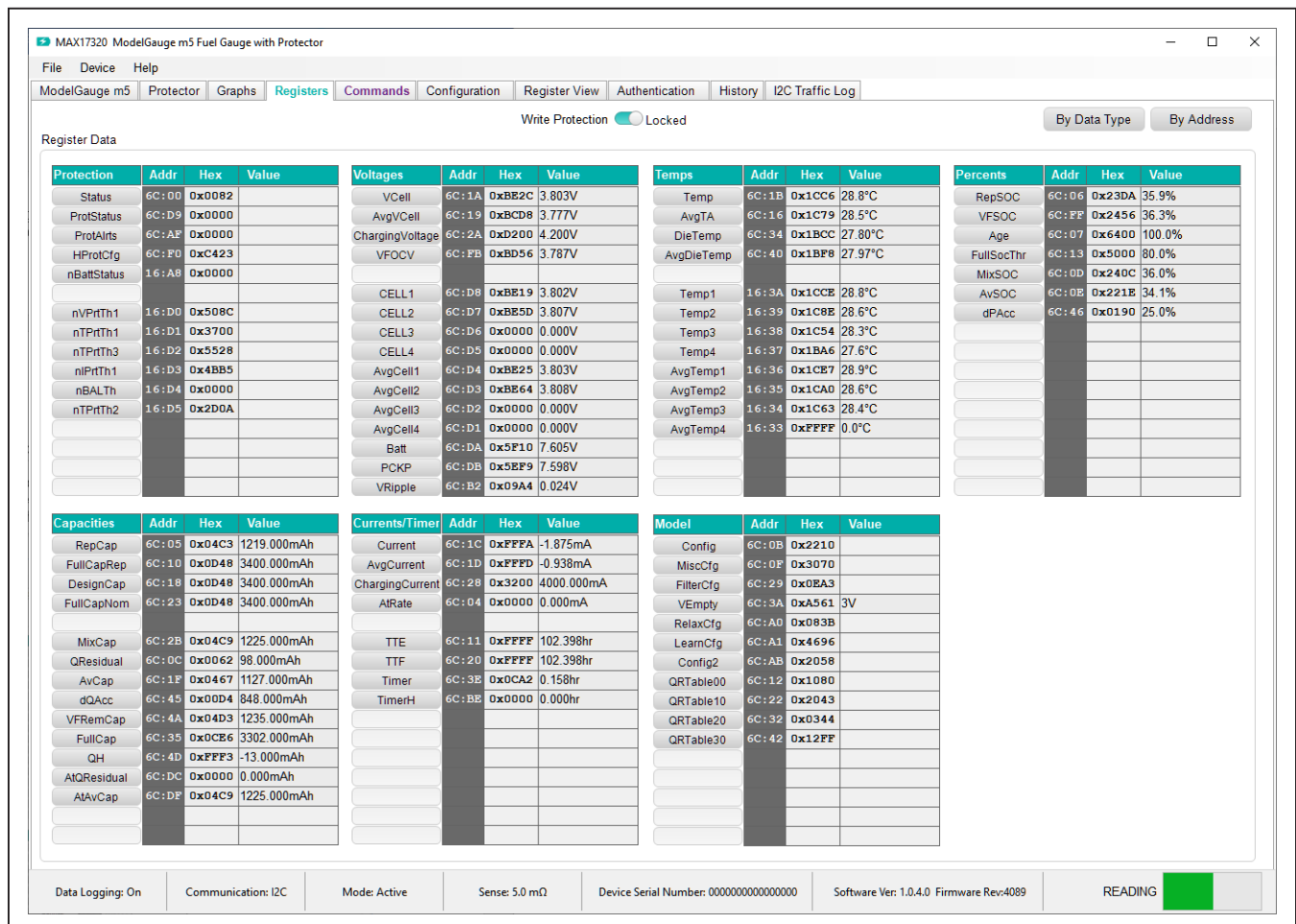

Figure 7. Registers Tab

Commands Tab

The **Commands** tab in [Figure 8](#) allows the user to access any general IC functions not related to normal writing and reading of register locations. Each group box of the **Commands** tab is described in detail in the following sections.

1-Wire Communication Speed

This option affects 1-Wire ICs only. The user can select either standard or overdrive communication speed. Communication speed is controlled by the EV kit software by driving the OD pin of the IC high or low. Regardless of

the desired communication rate, the kit software communicates with any IC it discovers at either communication speed. The actual communication speed is displayed in the bottom status bar of the EV kit window.

Read/Write Register

The user can read a single register location by entering the address in hex and clicking the **Read** button. The user can write a single register location by entering the address and data in hex and clicking the **Write** button. The read loop is temporarily paused each time to complete this action.

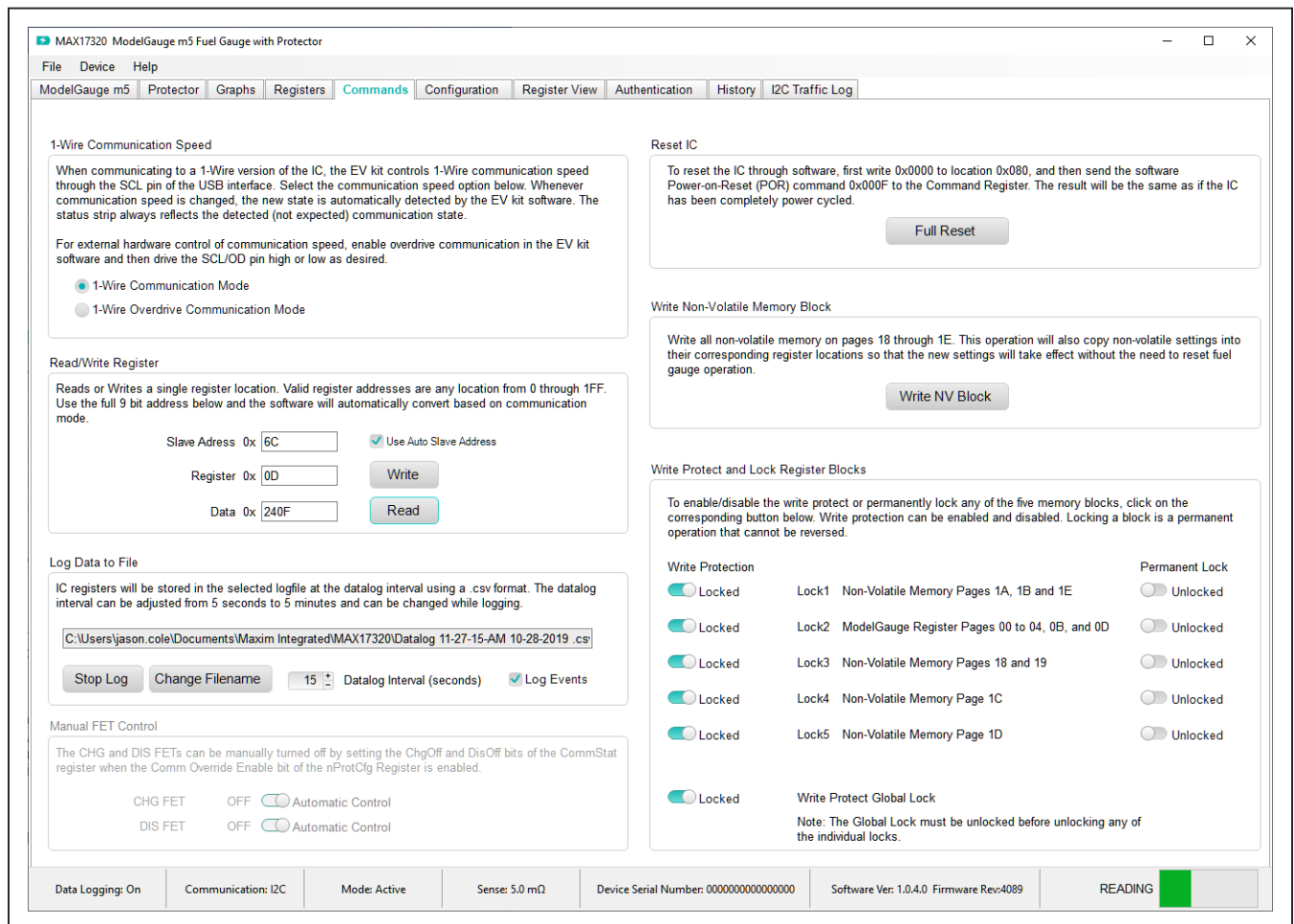

Figure 8. Commands Tab

Log Data to File

Data logging is always active when the kit software is started. The default data log storage location is the My Documents/Maxim Integrated/MAX17320/Datalog.csv. The user can stop data logging by clicking the **Stop Log** button or change the data log file name by clicking the **Change Filename** button. Whenever data logging is active, it is displayed on the bottom status bar of the EV kit window. All user available IC registers are logging in a .csv formatted file. The user can adjust the logging interval at any time. The user can also enable or disable the event logging at any time. When event logging is enabled, the data log also stores any IC write or reads that are not part of the normal read data loop and indicates any time communication to the IC is lost.

Manual FET Control

Before using the **Manual FET Control**, the function must be enabled in the IC by clicking the **Enable FETs Off-Override by I2C / 1Wire Command** in Step 7 of the **Configuration Wizard**. Clicking the appropriate slider can open the either FET or return control of the FET to the IC. **Note:** The user only has the ability to open the FETs or pass control back to the IC. The user cannot close the FET if the IC has opened the FET in order to protect the battery.

Reset IC

Clicking the **Full Reset** button sends the software POR command to the command register and sets the POR_CMD bit of the Config2 register to fully reset fuel-gauge operation as if the IC had been power cycled. Note that resetting the IC when the cell is not relaxed causes fuel gauge error.

Write Non-Volatile Memory Block

Clicking the **Write NV Block** button sends the Copy NV Block command to the command register that causes all register locations from 180h to 1DFh to be stored to nonvolatile memory. Nonvolatile memory has a limited number of copies and the user is prompted to confirm prior to executing the copy.

Write Protect and Lock Register Blocks

Clicking one of the six **Write Protection** sliders locks or unlocks a page or pages of memory as listed. Prior to unlocking any individual block, the Global Lock slider must first be unlocked.

Clicking one of the five **Permanent Lock** sliders locks a page or pages of memory as listed. This is a permanent operation, so the user is prompted to confirm the operation prior to setting the lock.

Configuration Tab

The **Configuration** tab has similar formatting to the standard **Registers** tab as shown in [Figure 9](#), but there are some major differences. When the user changes a register value on the **Configuration** tab, only the RAM value of that location is changed. The nonvolatile value remains unchanged. Register text changes to **BLUE** to indicate the RAM and nonvolatile values do not match. The user must complete a nonvolatile burn on the **Commands** tab or run the **Configuration Wizard** to change the nonvolatile value. The nonvolatile memory has a limited number of updates that is shown in a box on the top right side of

the tab. Maxim recommends using the **Configuration Wizard** to make any changes to nonvolatile memory instead of changing registers manually. The wizard can be launched through the **Device** drop-down menu at the top of the EV kit software window or by the button on the top-right of the **Configuration** tab. See the [Configuration Wizard](#) section for details. Note any register information that is displayed in **RED** text indicates a nonvolatile write error where the data read back after a nonvolatile memory write does not match the expected value. Also note, the **Write Protection** must be unlocked before modifying any registers.

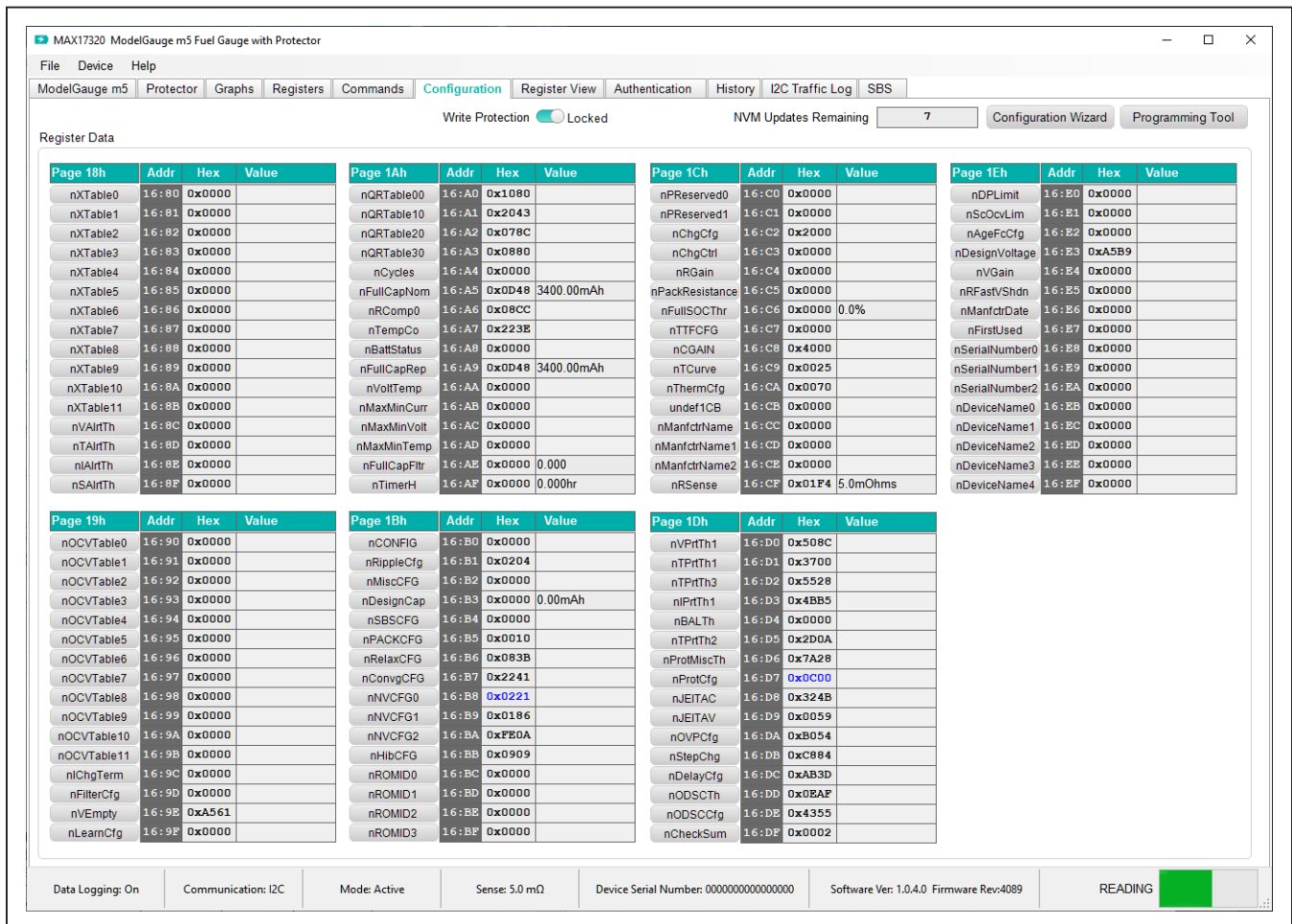

Figure 9. Configuration Tab

Register View Tab

The **Register View** tab provides a convenient interface to visualize and update the register settings in binary format. As shown in [Figure 10](#), all configuration register names are listed on the left side of the **Register View** Tab. When one register is selected, detailed information about the register is displayed on the right-side panel. The corresponding name and binary value of each bitfield of the selected register are displayed on the top table. Clicking the **Read Register 0x00F** button refreshes the view and load the register reading into the top table. Single click on the binary bitfield to edit the register setting directly. When all the desired bitfield settings are updated, click

the **Write Register 0x00F** button to update the register value. If the change needs to be aborted, click the **Read Register 0x00F** button to reload the register value. The table on the bottom right lists all the bit descriptions and reset values based on the IC data sheet. Refer to the description of the bitfield for how to set the bitfield. The **Find: Bit Fields** feature is located at the bottom left of the **Register View** tab. To find a bitfield, type in the bitfield name in the **Find: Bit Fields** menu bar. The search result is available in the drop-down list. The **History** menu at the bottom left shows all the history searches from the **Find: Bit Fields** menu.

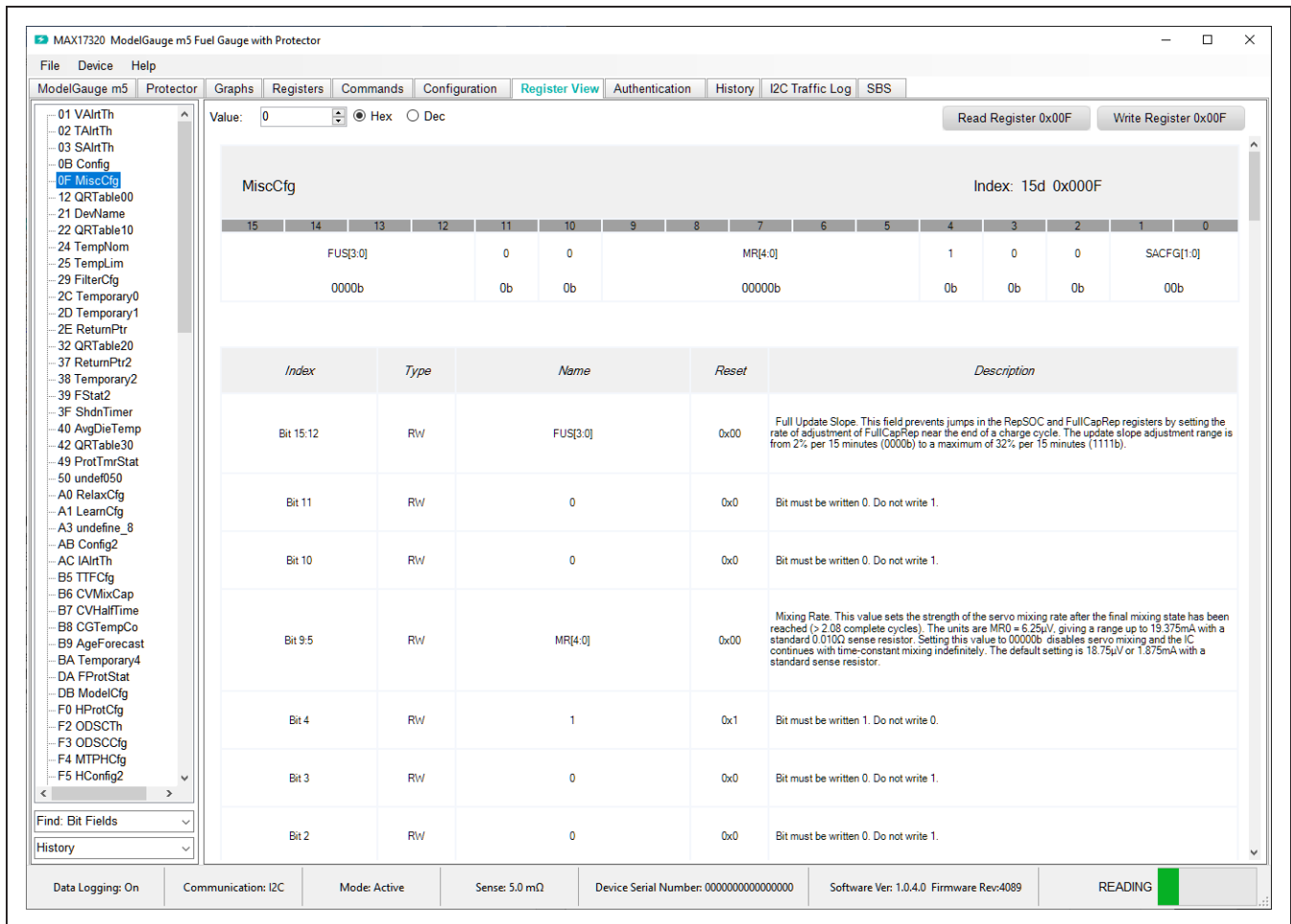

Figure 10. Register View Tab

Authentication Tab

The **Authentication** tab in [Figure 11](#) allows full evaluation of the SHA-256 battery security feature for the MAX17320 fuel-gauge. Each group box of the **Authentication** tab is described in detail in the following sections.

SHA Challenge / ROM ID

The 160-bit SHA-256 Challenge message consists of ten 16-bit Challenges. To manually enter the challenge message, click the hex value field of each challenge number and edit the value in the text box. Click the **Randomize Challenge** button to create a random challenge message.

SHA Secret

The 160-bit SHA-256 secret key consists of ten 16-bit Secret values. Unless the secret is specifically programmed by Maxim Integrated for the customer, the default key value is 0. To prepare for authentication with the IC, enter the known secret value for the IC connected to GUI. Click **Clear Secret** to reset the key values in the IC to 0. Note that is not possible to clear the secret if the secret is locked. Click **Lock Secret** to permanently lock the secret value for

the IC. **Secret Changes Remaining** shows the remaining chances to update SHA Secret value.

SHA Authentication Results

This group box provides four method to perform authentication evaluation. When the authentication process begins, the IC calculates MAC based on the challenge and stored secret value. The GUI, which represents the host side processor, also calculates based on the challenge and secret. If the **SHA Secret** is entered correctly matching the programmed secret state in the IC, the authentication should succeed given any challenge using any of the four methods. **Compute MAC with ROM ID** computes the MAC result based on the chip ROM ID that is specific to the chip. **Compute MAC without ROM ID** does not involve ROM ID computation, which means the MAC result for every chip given the same challenge and secret should be the same. **Compute Next Secret with ROM ID** commands not only computes the authentication result, but also updates the secret value [Secret0...Secret9] to [MAC6...MAC15]. If there is no **Secret Changes Remaining** displayed in the **SHA Secret** group or the secret is locked, the secret does not update.

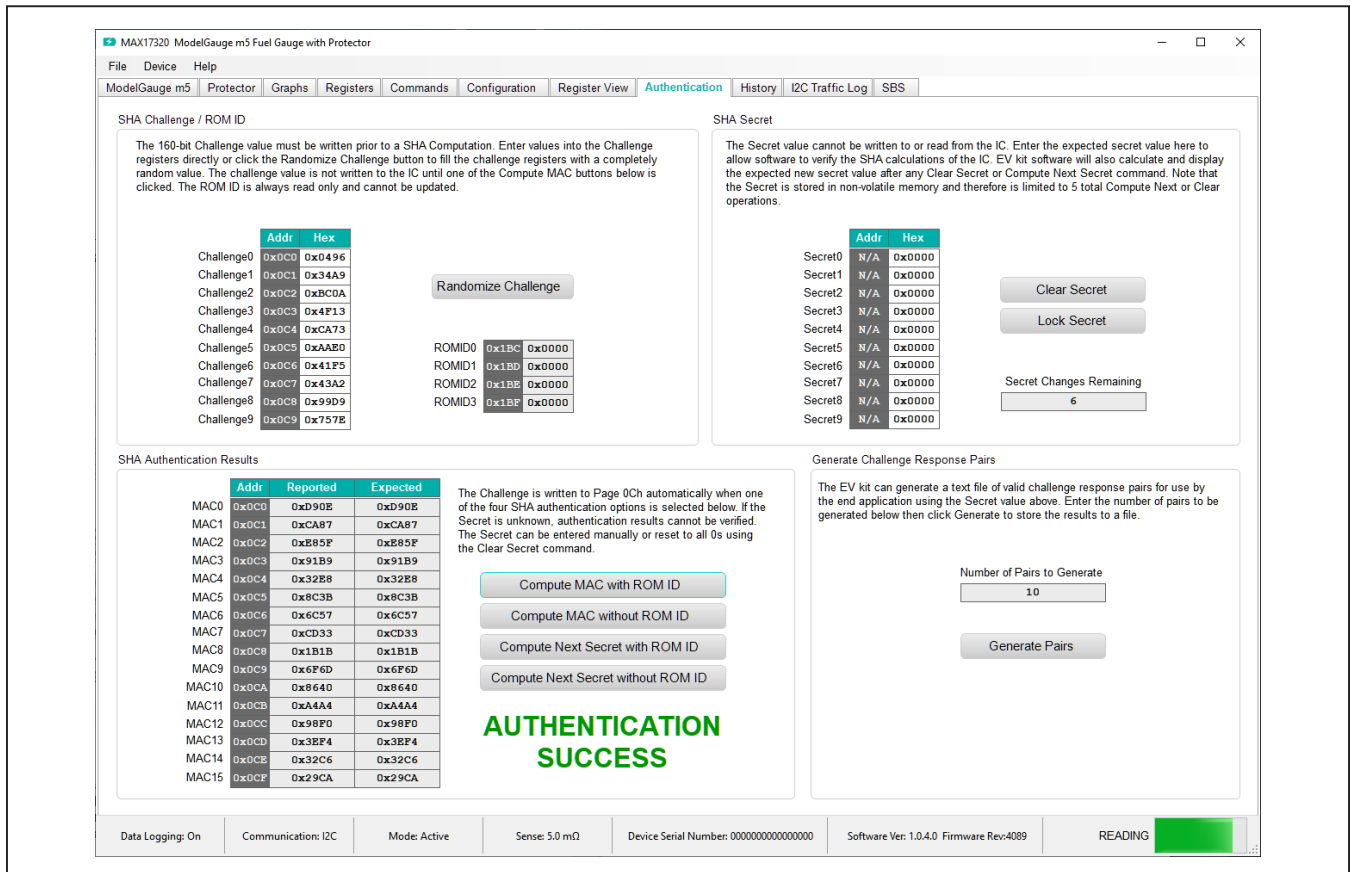

Figure 11. Authentication Tab

History Tab

The **History** tab visualizes all nonvolatile update history on 0x1Ax column of the nonvolatile memory map. [Figure 12](#) shows the **History** tab. This column of nonvolatile memory features Fibonacci Saving mechanism to help the IC efficiently learn and adapt to battery characteristics change. The column of memory changes by nonvolatile programming and updates automatically as the battery pack experience through usage cycles.

In the **Read History** group box, click the **Read Battery History** button to initiate the nonvolatile history recall process. Once the process is initiated, it takes a while to load the nonvolatile history from the IC. Click the **Read History and Save to File** to save the nonvolatile history to a csv file in addition to initiate the nonvolatile history recall process. After the recall process is finished, enter in page number or select + or – sign to browse through the nonvolatile history at the **Display History Data from Page** tool. The detailed information is displayed in the **Logging History** section.

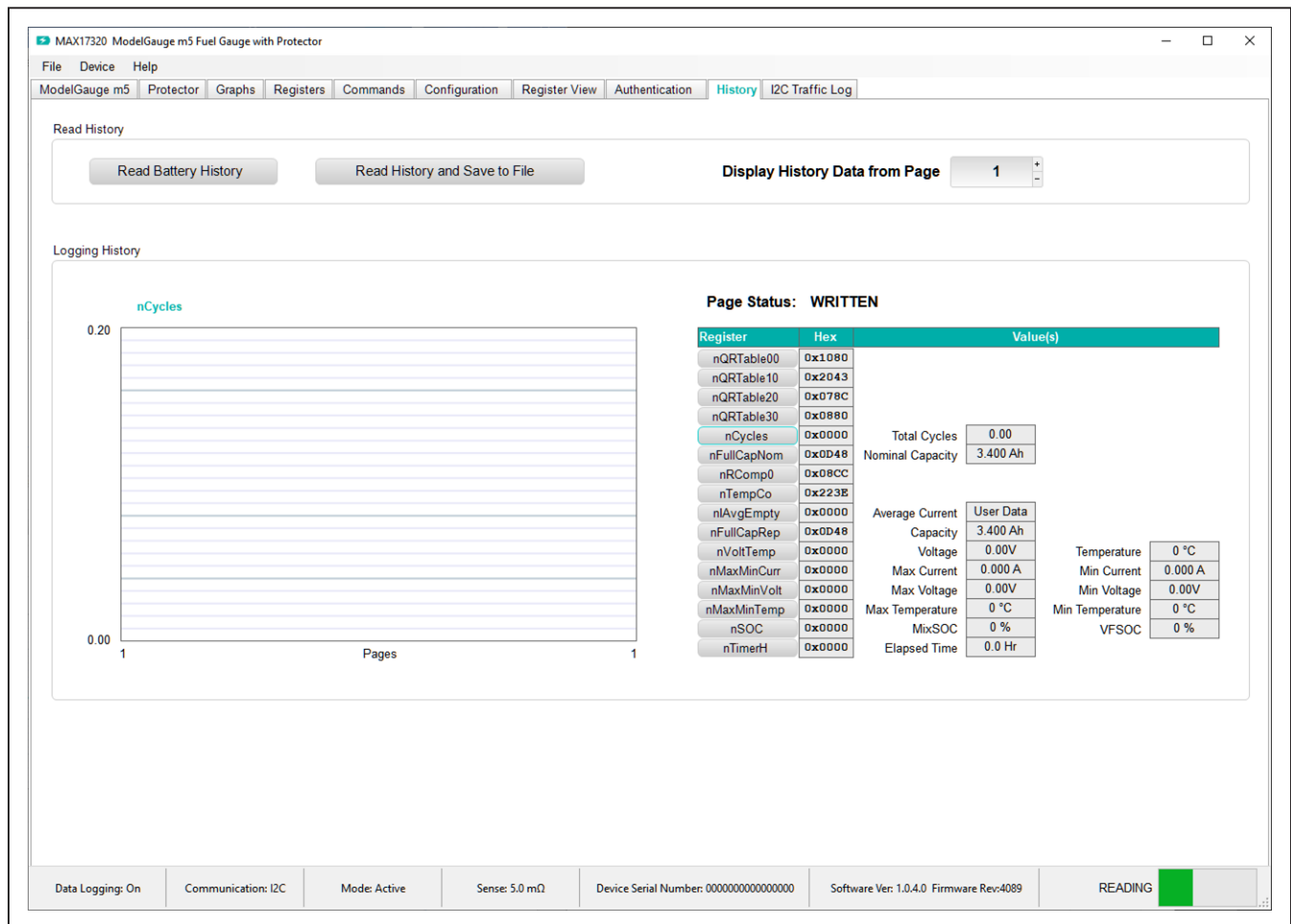

Figure 12. History Tab

Configuration Wizard

Before the IC accurately fuel gauges the battery pack, it must be configured with characterization information. This can be accomplished two ways. The first is through a custom characterization procedure that can be performed by Maxim under certain conditions. The result is an model.INI summary file that contains information that can be programmed into the IC by launching the Configuration Wizard and selecting the model.INI file in Step 2. Contact Maxim for details on this procedure.

The second method is ModelGauge m5 EZ configuration. This is the default characterization information shipped inside every IC. This default model produces accurate results for most applications under most operating conditions. It is the recommended method for new designs as it bypasses the custom cell characterization procedure. Some additional information is required from the user for EZ configuration initialization.

In the **Configuration** tab, click **Configuration Wizard** button. The **Configuration Wizard** window pops up, as shown in [Figure 13](#). Follow the description and complete all the steps in **Configuration Wizard**. Click **Next** when each step is finished.

Step 1 shows the options for how to start with nonvolatile programming. For previously unprogrammed chip, select **Start with Factory Default Values** to begin evaluation. If there are already nonvolatile memory changes in the IC to be kept, select **Start with Existing Nonvolatile Memory Data**.

Step 2 shows the critical model selection options. Enter the Sense resistor value into the **Sense (mOhms)** text box. For EZ configuration without using INI file, select the **Use ModelGauge m5 EZ Model** option. Enter the rated battery capacity, empty voltage (minimum safe system supply voltage), charge termination current and check the checkbox if charge voltage is greater than 4.275V. If INI file is available, select **Use Custom Model and Other Configuration Registers from Model.INI or Complete .INI File** and load model INI file provided by Maxim directly.

In **Step 3**, the basic **Schematic Configuration** is selected including the **number of cells**, **number of thermistors**, **Always On LDO Output** setting and **Gate Driver Voltage** setting.

In **Step 4**, the cell **Balancing Configuration (mV)** is selected.

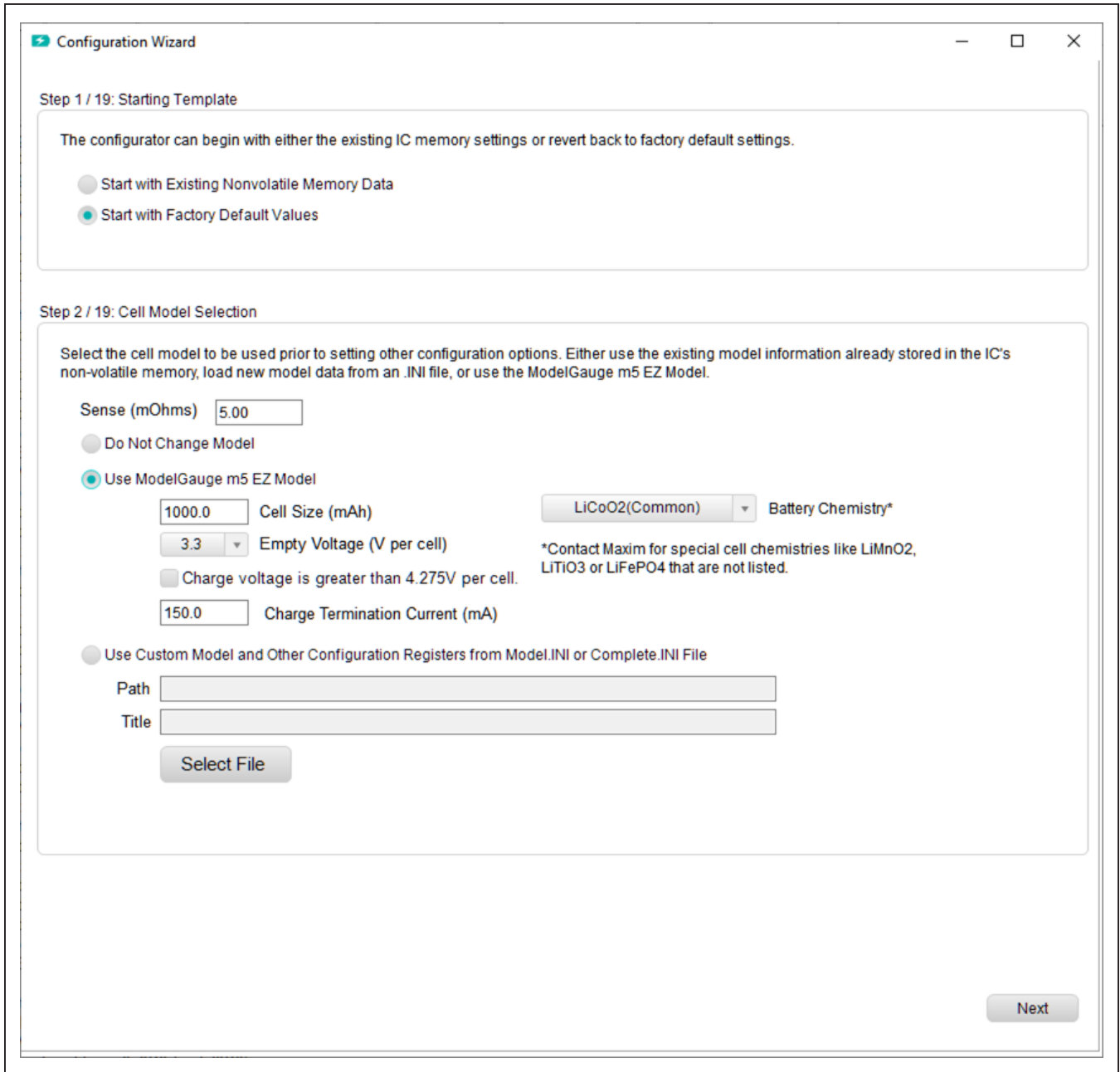

Figure 13. Configuration Wizard—Step 1 and 2

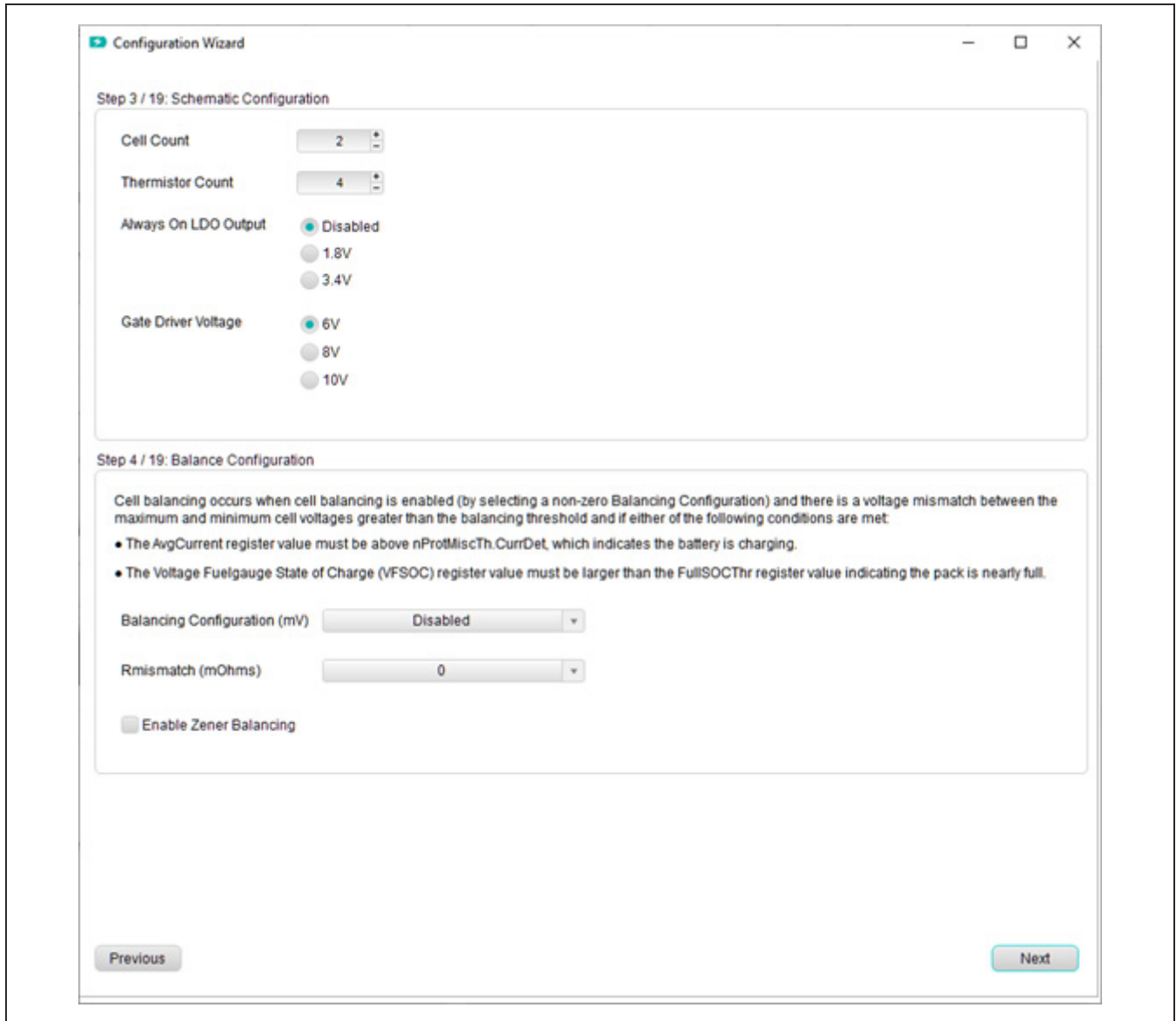

Figure 14. Configuration Wizard—Step 3 and 4

In **Step 5**, charge protection-related settings need to be configured. [Figure 15](#) shows this step. The check-boxes at the bottom right enable or disable the protection features. The **Enable Protection** feature need to be checked to enable protection. JEITA charging allows the IC to calculate and report the required charging voltage and charging current base on temperature condition. If JEITA Charging feature is desired, check the Enable JEITA checkbox. JEITA protection allows the IC to protect

charging at different charging rate base on temperature condition. Check the **Enable JEITA Protection** to enable this feature. The upper section of the panel visualizes the JEITA temperature zones and protection thresholds. In the lower section, user can edit detailed settings like the temperature zone setting, OVP setting, charging voltage settings, and charging current setting. When all the JEITA settings are completed, check the upper section graph to make sure settings are correct.

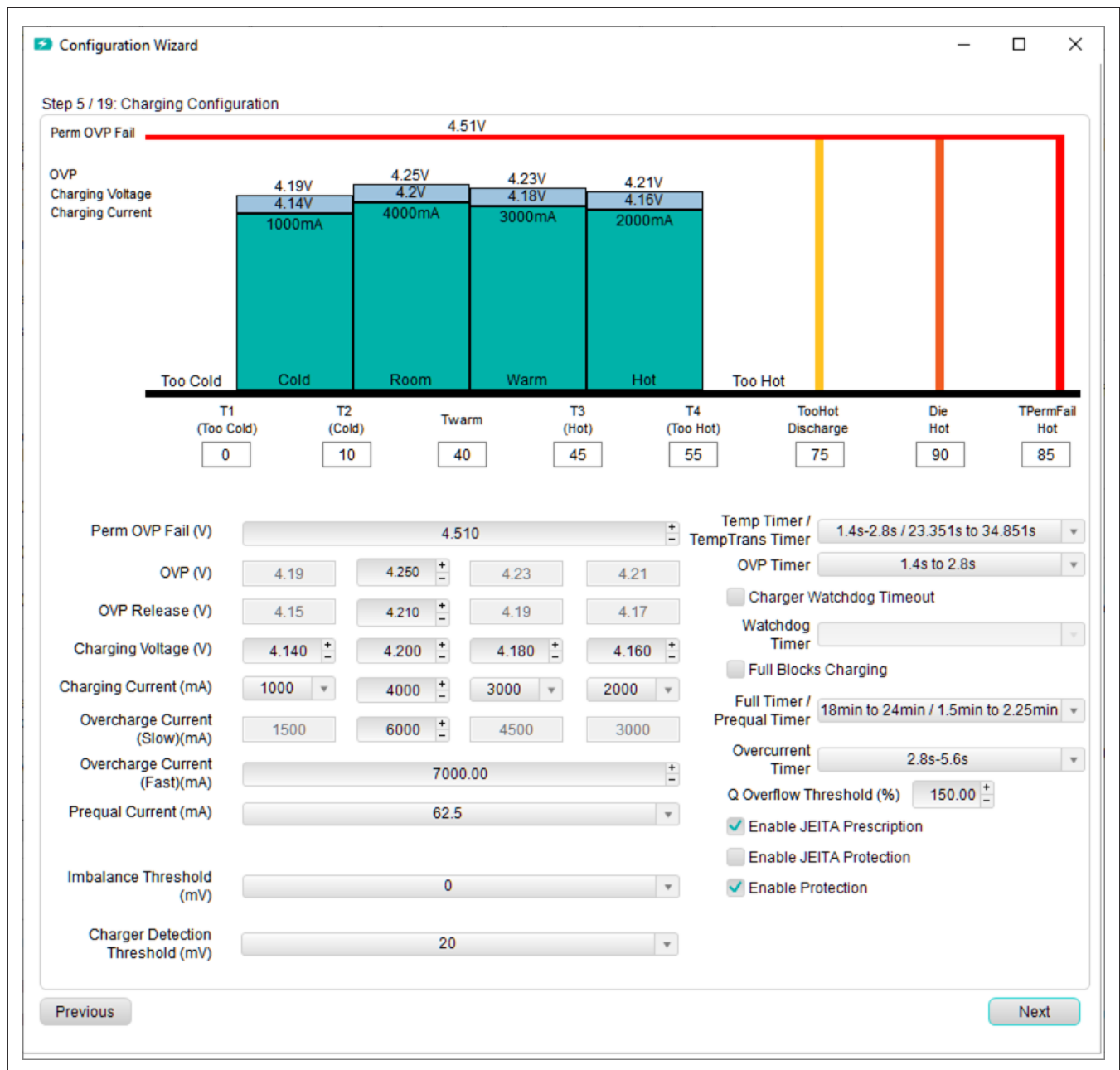

Figure 15. Configuration Wizard—Step 5

From **Step 6** to **Step 8**, user can edit the discharge protection parameters. See [Figure 16](#) and [Figure 17](#). The parameters include detailed protection configurations, thresholds and timings. In Step 7, user can enable and configure the Battery Internal Self-Discharge Detection. In **Step 9**, choose the power mode for fuel-gauge device. Enabling hibernate mode allows reduction of current consumption by lowering the rate of ADC sampling. Enabling Deepship mode opens the FETs and shuts down any protection functionality during shipping and storage condition. In **Step 10**, check the **Battery Out** option

to allow communication stop shutdown feature. Check **Pushbutton Wakeup** to allow wakeup fuel-gauge using the ALRT pin.

From **Step 11** to **Step 19**, follow along the step description to fill out all the application specific information related to fuel-gauging. Typically leave options from **Step 11** to **Step 19** as default. If there is special thermistor requirement, look for the NTC model with closest beta value in the drop-down list. If the thermistor beta value is not covered by the models in the drop-down list, contact Maxim for support.

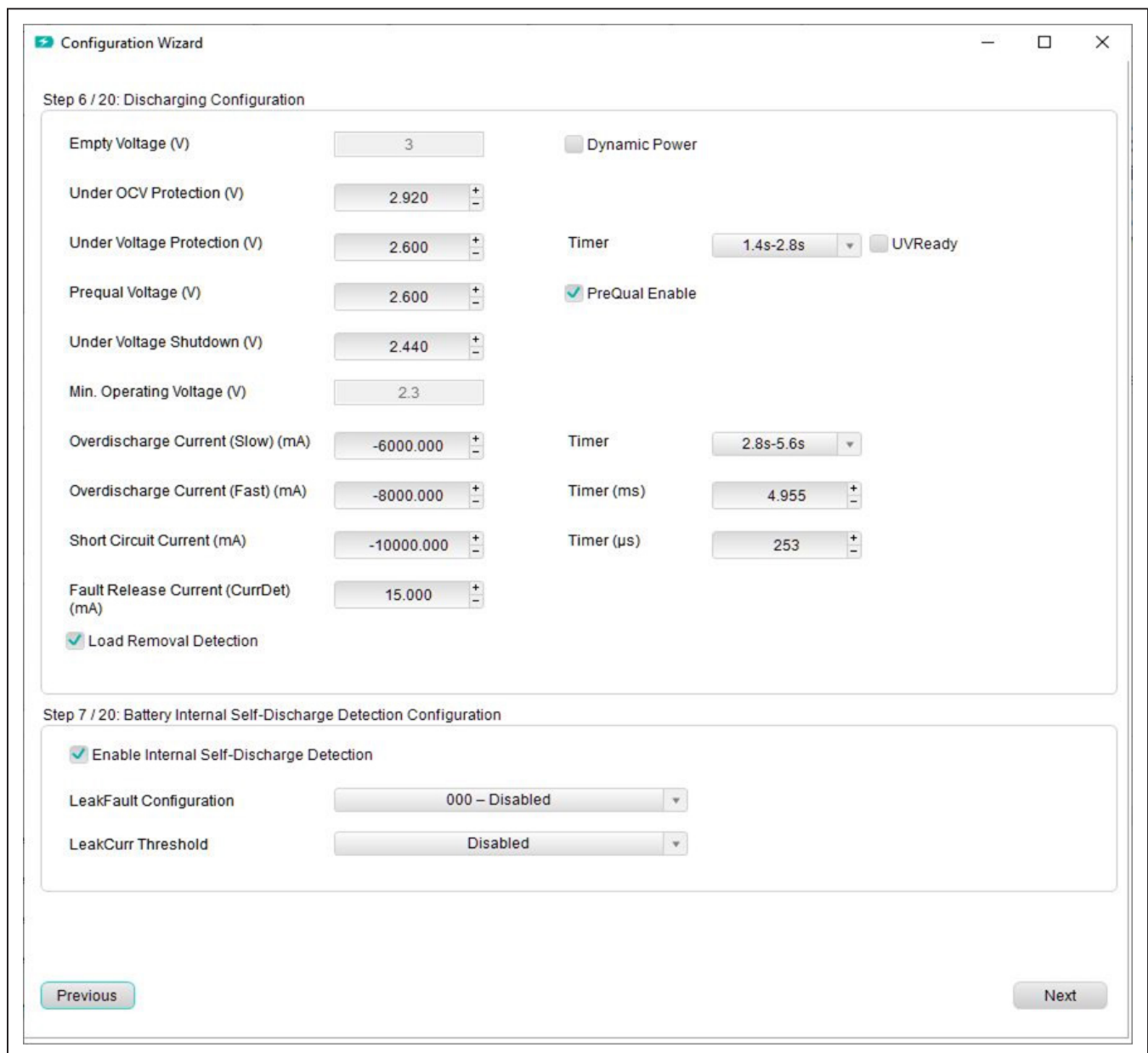

Figure 16. Configuration Wizard—Step 6 and 7

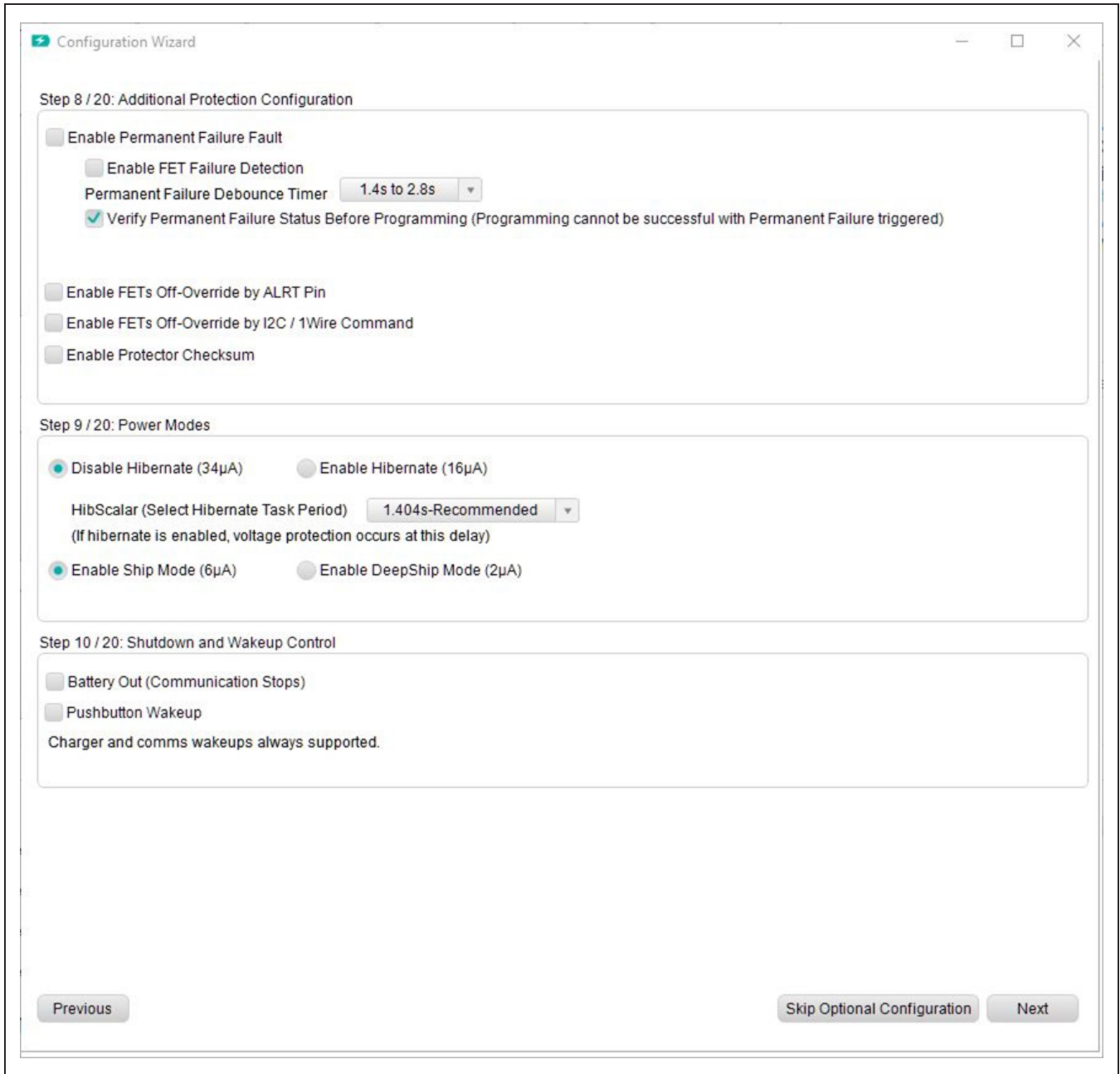

Figure 17. Configuration Wizard—Step 8, 9, and 10

In **Step 20**, user can choose to update the IC based on previous configuration steps. See [Figure 18](#). The nonvolatile configuration memory can only be updated 7 times. User can choose to only update RAM by selecting the second option. This is a good method to evaluate previous settings without updating the nonvolatile memory. In this mode, if the IC is power cycled, the configuration is lost. If final configuration is decided, choose the third option

Program New Configuration to Non-Volatile Memory. It is recommended to check **Save New Configuration Settings to .INI file**. This allows resulting configuration in previous steps to be recorded in a Complete INI file. When **Configuration Wizard** is closed, the previous configurations are not be remembered. Click **Update IC** button to execute the changes and saves. Click **Close** button to exit configuration wizard without doing anything.

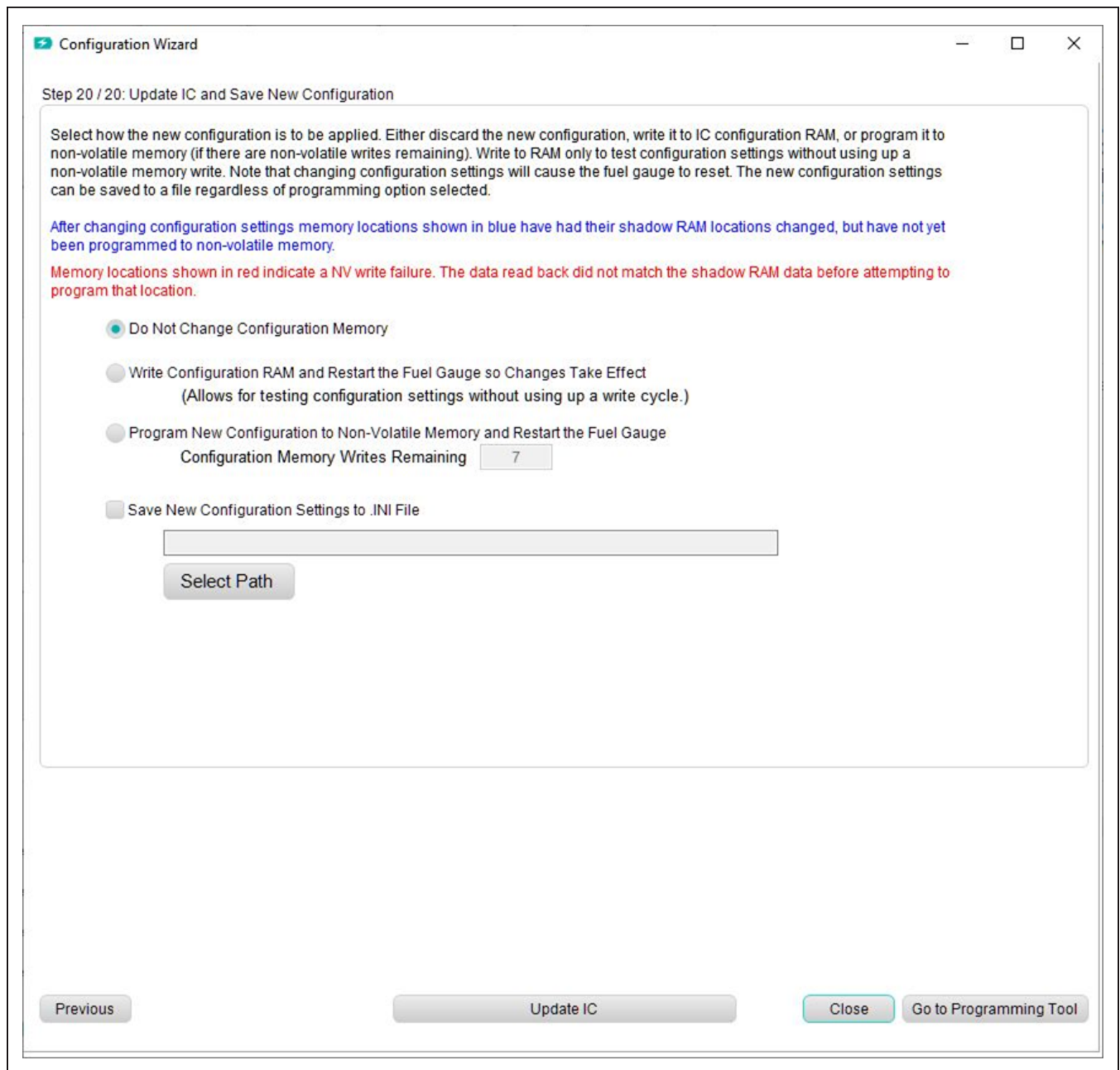

Figure 18. Configuration Wizard—Step 20

Programming Tool

INI file provided by Maxim includes battery characteristic model only and is referred to as a model.INI file. It does not include custom settings for protector and device operation. The model.INI file must be used with the **Configuration Wizard** to create a complete.INI file. After completion of **Configuration Wizard**, a Complete.INI is generated with all nonvolatile register configurations. With a Complete.INI, user doesn't need to go through configuration wizard again. See [Figure 19](#). In the **Programming Tool** panel, click **Select File** to select the saved Complete.INI

configuration file. The configuration file is typically saved from configuration step in the **Configuration Wizard** as shown in [Figure 18](#). Click **Program IC** to program non-volatile memory directly. When there is a minor change required on one or two nonvolatile registers, edit the registers inside the complete configuration INI file using text editor, then program the IC using the programming tool. Manually editing the INI file is generally discouraged and should be done with extreme caution. User can choose to only update the RAM by checking the **Load INI to RAM** checkbox.

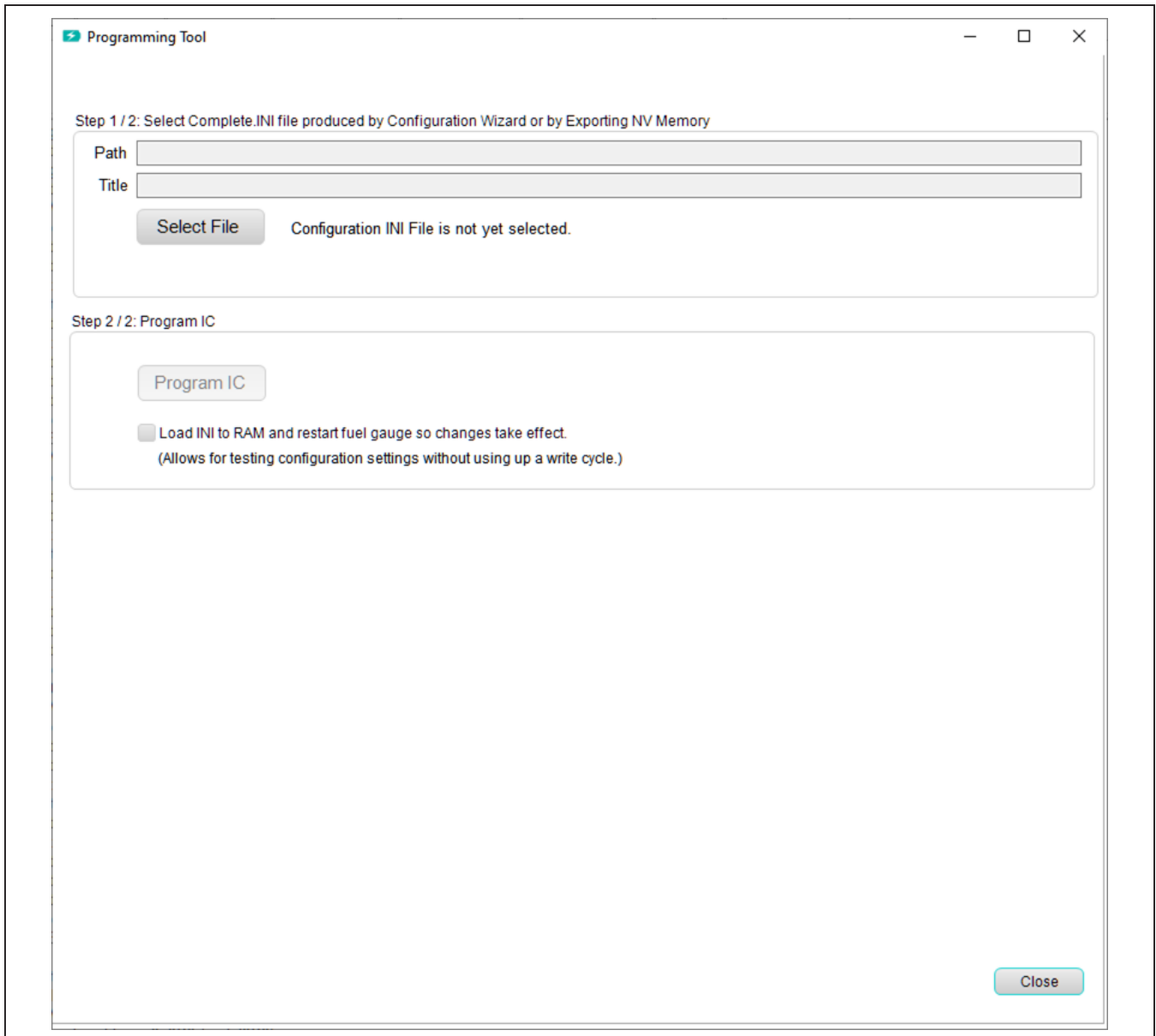

Figure 19. Programming Tool

Hardware Connection Guideline

When evaluating MAX17320 EV kit with high current or evaluating protection functionality, use real batteries instead of power supplies. When connecting batteries, use soldered connection instead of jumper cables. During protector switching event, the impedance caused by inductance of the lab jumper cables and power supply can cause overshoot on battery voltage. This voltage spike could potentially cause voltage across any of the

BATTx pins to rise above the absolute maximum rating of 6V, damaging the chip permanently. [Figure 20](#) show good example of a battery connection using soldered connections, battery connectors, and its corresponding BATT voltage waveform during a switching event. [Figure 21](#) show bad example of a battery connection using lab jumper wires and its corresponding BATT voltage waveform.

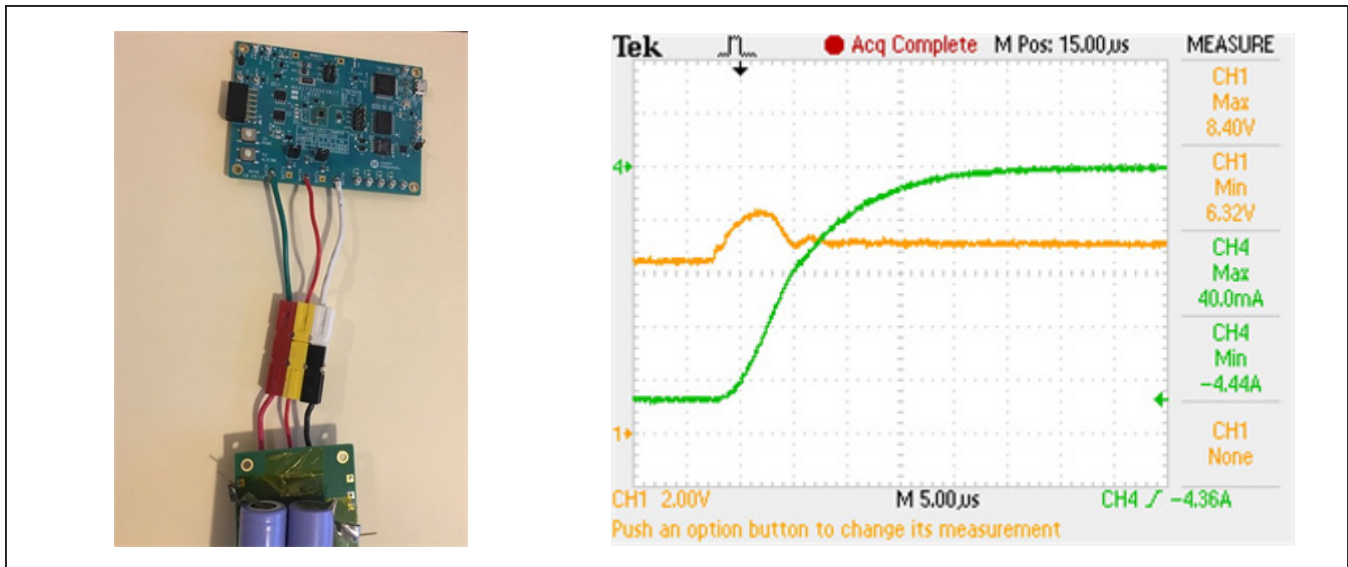

Figure 20. Good Hardware Connection Example (Use Real Batteries and Soldered Connections). BATT Voltage and Battery Current Waveform at Overcurrent Protection Event with Good Connection

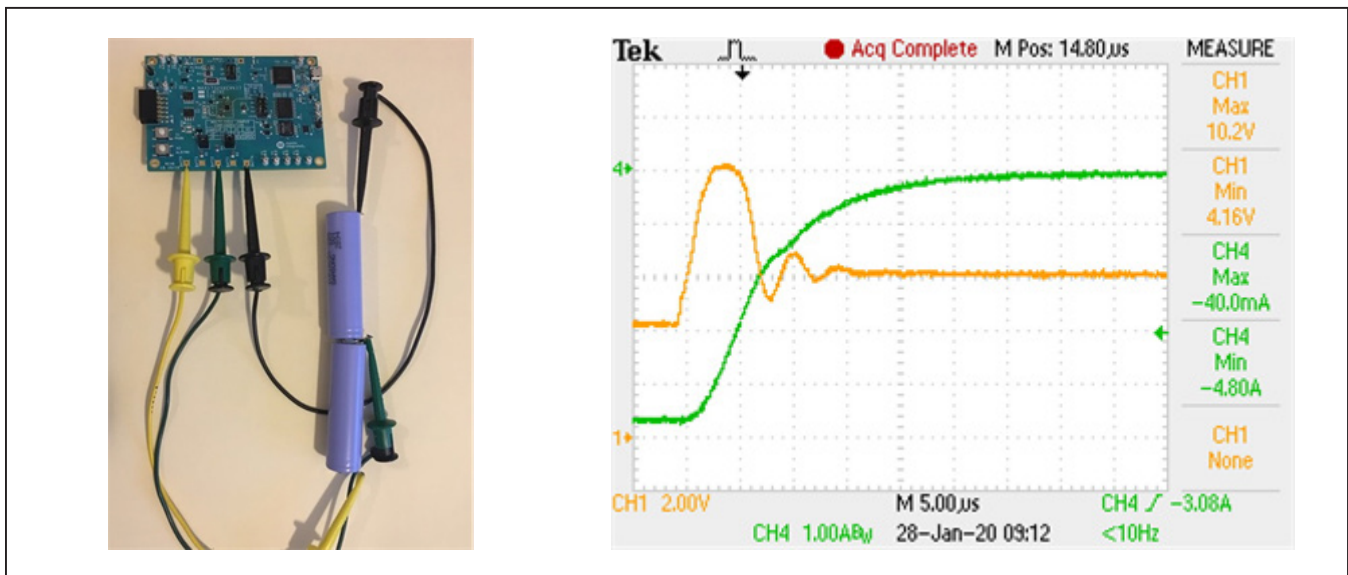

Figure 21. Bad Hardware Connection Example (Use Lab Jumper Cable). BATT Voltage and Battery Current Waveform at Overcurrent Protection Event with Bad Connection

MAX17320X/MAX17320G Evaluation Kits

Evaluate: MAX17320

Component Suppliers

SUPPLIER	PHONE	WEBSITE
Murata Electronics North America, Inc.	770-436-1300	www.murata.com/en-us
TDK Corp.	847-803-6100	www.component.tdk.com
Vishay	402-563-6866	www.vishay.com

Note: Indicate that the MAX17320 is being used when contacting these component suppliers.

Ordering Information

PART NUMBER	INTERFACE	U1 IC	PIN-PACKAGE
MAX17320X1EVKIT#	1-Wire	MAX17320X12+	30 WLP
MAX17320X2EVKIT#	I ² C	MAX17320X22+	30 WLP
MAX17320G1EVKIT#	1-Wire	MAX17320G12+	24 TQFN
MAX17320G2EVKIT#	I ² C	MAX17320G22+	24 TQFN

#Denotes RoHS compliance.

MAX17320X/MAX17320G Evaluation Kits

Evaluate: MAX17320

MAX17320X EV Kit Bill of Materials

REF_DES	DNI/DNP	QTY	MFG PART #	MANUFACTURER	VALUE	DESCRIPTION
ALRT, AOLDO, RT-, RT1+-RT4+, SCL_SCL1, SDA, SDA1, VUSB	-	12	5002	KEystone	N/A	TEST POINT; PIN DIA=0.1IN; TOTAL LENGTH=0.3IN; BOARD HOLE=0.04IN; WHITE; PHOSPHOR BRONZE WIRE SILVER;
C1, C3	-	2	LMK105B7474KV	PANASONIC	0.47UF	CAPACITOR; SMT (0402); CERAMIC CHIP; 0.47UF; 10V; TOL=10%; TG=-55 DEGC TO +125 DEGC; TC=X7R
C2, C43	-	2	C1005X5R1E474K050;GRT155R61E474KE01	TDK/MURATA	0.47UF	CAPACITOR; SMT (0402); CERAMIC CHIP; 0.47UF; 25V; TOL=10%; TG=-55 DEGC TO +85 DEGC; TC=X5R
C4, C7, C19, C26	-	4	C0402C105K8PAC;C0402KXSR08B105	KEMET;YAGEO	1UF	CAPACITOR; SMT (0402); CERAMIC CHIP; 1UF; 10V; TOL=10%; TG=-55 DEGC TO +85 DEGC; TC=X5R
C5	-	1	C0402C103K5RAC;GRM155R71H103KA88;C1005X7R1H103K050B6E;CL05B103KB9NN;UMK105B7103KV	KEMET;MURATA;TDK;SAMSUNG ELECTRONIC;TAYO YUDEN	0.01UF	CAPACITOR; SMT (0402); CERAMIC CHIP; 0.01UF; 50V; TOL=10%; TG=-55 DEGC TO +125 DEGC; TC=X7R
C6, C8, C10, C11	-	4	CL05B103KPSNN	SAMSUNG ELECTRONICS	0.01UF	CAPACITOR; SMT (0402); CERAMIC; 0.01UF; 10V; TOL=10%; TG=-55 DEGC TO +125 DEGC; TC=X7R
C9, C12-C15, C21, C22, C24, C25, C28-C38	-	20	GRM155R71E104KE14;C1005X7R1E104K050BB;TMK105B7104KVH;COJ2B3X7R1E104K050BB	MURATA;TDK;TAYO YUDEN;TDK	0.1UF	CAPACITOR; SMT (0402); CERAMIC CHIP; 0.1UF; 25V; TOL=10%; MODEL=GRM SERIES; TG=-55 DEGC TO +125 DEGC; TC=X7R
C20, C23, C27	-	3	ZR815XR614475ME01;CL05A475MPSNN;GRM155R61A475MEAA;C1005X7R1A475M050BC	MURATA;SAMSUNG;MURATA;TDK	4.7UF	CAPACITOR; SMT (0402); CERAMIC CHIP; 4.7UF; 10V; TOL=20%; TG=-55 DEGC TO +85 DEGC; TC=X5R
C39, C40	-	2	C0402C0G500270JNP; GRM1555C1H270JA01	VENKEL LTD.;MURATA	27PF	CAPACITOR; SMT; 0402; CERAMIC; 27pf; 50V; 5%; C0G; -55degC to + 125degC; 0 +/-30PPM/degC
C41, C42	-	2	GRM155R71A104JA01	MURATA	0.1UF	CAPACITOR; SMT (0402); CERAMIC CHIP; 0.1UF; 10V; TOL=5%; TG=-55 DEGC TO +125 DEGC; TC=X7R
D1-D2	-	1	LTST-C190CKT	LITE-ON ELECTRONICS INC.	LTST-C190CKT	DIODE; LED; STANDARD; RED; SMT (0603); PIV=5.0V; IF=0.04A; -55 DEGC TO +85 DEGC
D2-D4, D10	-	4	BZX384-C5V6	NXP	5.6V	DIODE; ZNR; SMT (SOD-323); Vz=5.6V; Izm=0.000001A; -65 DEGC TO +150 DEGC
D5, D6	-	2	MBR0520	MICRO COMMERCIAL COMPONENTS	MBR0520	DIODE; SCH; SCHOTTKY RECTIFIER; SMT (SOD-123); PIV=20V; IF=0.5A; -55 DEGC TO +150 DEGC
D7	-	1	SD103AWS	MICRO COMMERCIAL COMPONENTS	SD103AWS-TP	DIODE; SCH; SMALL SIGNAL SCHOTTKY DIODE; SOD-323; PIV=40V; IF=0.35A
D8	-	1	RB751S40	FAIRCHILD SEMICONDUCTOR	RB751S40	DIODE; SCH; SMT (SOD-523F); PIV=40V; IF=0.03A
D9	-	1	SD101BWS-E3	VISHAY	SD101BWS-E3	DIODE; SCH; SMT (SOD-323); PIV=50V; IF=0.03A
DGND, GND	-	2	5011	KEystone	N/A	TEST POINT; PIN DIA=0.125IN; TOTAL LENGTH=0.445IN; BOARD HOLE=0.063IN; BLACK; PHOSPHOR BRONZE WIRE SILVER PLATE FINISH;
DS1, DS2	-	2	LTST-C190CKT	LITE-ON ELECTRONICS INC.	LTST-C190CKT	DIODE; LED; WATER CLEAR GREEN; SMT (0603); VF=2.1V; IF=0.03A; -55 DEGC TO +85 DEGC
F1	-	1	SFJ-1215J	DEXTERALS	SFJ-1215J	EVKIT PART - FUSE; SELF CONTROL PROTECTOR; SFJ SERIES; 3-CELL; 15A
J1	-	1	10118193-0001LF	FCI CONNECT	10118193-0001LF	CONNECTOR; FEMALE; SMT; MICRO USB B TYPE RECEPTACLE; RIGHT ANGLE; 5PINS
J2, J5	-	2	PBC02SAAN	SULLINS ELECTRONICS CORP.	PBC02SAAN	EVKIT PART-CONNECTOR; MALE; THROUGH HOLE; BREAKAWAY; STRAIGHT; 2PINS; -65 DEGC TO +125 DEGC;
J4	-	1	PBC03DAAN	SULLINS ELECTRONICS CORP.	PBC03DAAN	CONNECTOR; MALE; THROUGH HOLE; BREAKAWAY; STRAIGHT; 6PINS; -65 DEGC TO +125 DEGC
J8	-	1	PPPC06ZLJBN-RC	SULLINS ELECTRONICS CORP.	PPPC06ZLJBN-RC	CONNECTOR; FEMALE; THROUGH HOLE; 0.1IN CC; HEADER; 2 ROW; RIGHT ANGLE; 12PINS
L1-L3	-	3	BLM18AG601SM1	MURATA	600	INDUCTOR; SMT (0603); FERRITE-BEAD; 600; TOL=+/-; 0.5A
MISC1	-	1	AK67421-1-R	ASSMANN	AK67421-1-R	CONNECTOR; MALE; USB; USB2.0 MICRO CONNECTION CABLE; USB B MICRO MALE TO USB A MALE; STRAIGHT; 5PINS-4PINS
Q1, Q2	-	2	IRF7458PBF	INFINEON	IRF7458PBF	TRAN; SMPS MOSFET; NCH; NSOIC8; PD-(2.5W); I-(14A); V-(30V)
Q4, Q5	-	2	2N7002	NXP	2N7002	TRAN; N-CHANNEL TRENCH MOSFET; NCH; SOT-23; PD-(0.83W); I-(0.3A); V-(60V)
Q8	-	1	BSS223PW	INFINEON	BSS223PW	TRAN; OPTIMOS SMALL-SIGNAL-TRANSISTOR; PCH; SOT-233; PD-(0.25W); I-(0.38A); V-(20V)
R1, R3-R5	-	4	RNCP0805FTD48R9	STACKPOLE ELECTRONICS INC	49.9	RESISTOR; 0805; 49.9 OHM; 1%; 100PPM; 0.25W; THIN FILM
R2, R9	-	2	ERJ-2RK27R0X;RC0402FR-0727RL;CRCW040227R05FK	PANASONIC;YAGEO PHICOMP;VISHAY DALE	27	RESISTOR; 0402; 27 OHM; 1%; 100PPM; 0.0625W; THICK FILM
R6, R16, R34	-	3	CRCW04021K00FK;RC0402FR-071KL;MCR01MZPF1001	VISHAY DALE;YAGEO PHICOMP;ROHM SEMI	1K	RESISTOR; 0402; 1K; 1%; 100PPM; 0.0625W; THICK FILM
R8, R12, R13	-	3	CRCW0402150RFK; RC04021A1500FL	VISHAY DALE;YAGEO	150	RESISTOR; 0402; 150 OHM; 1%; 100PPM; 0.0625W; THICK FILM
R10	-	1	RT0402BRD0710RL	YAGEO	10	RES; SMT (0402); 10; 0.1%; +/-25PPM/DEGC; 0.063W
R11	-	1	CR0402-16W-3650FT	VENKEL LTD.	365	RESISTOR; 0402; 365 OHM; 1%; 100PPM; 0.063W; THICK FILM
R14, R15	-	2	CRCW0402100RFK; RC04021A1000FL; RC0402FR-07100RL	VISHAY DALE;PANASONIC;YAGEO PHYCOMP	100	RESISTOR; 0402; 100 OHM; 1%; 100PPM; 0.063W; THICK FILM
R17	-	1	W5LP12065L000F	VISHAY DALE	0.005	RESISTOR; 1206; 0.005 OHM; 1%; 400PPM; 1.0W; METAL FILM
R18	-	1	CRCW0402100RFK;RC0402FR-07100KL	VISHAY;YAGEO	100K	RESISTOR; 0402; 100K; 1%; 100PPM; 0.0625W; THICK FILM
R19	-	1	ERJ-1TNF4020U;CRCW2512402RFK	PANASONIC;VISHAY DALE	402	RESISTOR; 2512; 402 OHM; 1%; 100PPM; 1.0W; THICK FILM
R20, R25	-	2	CRCW040210K0JN	VISHAY DALE	10K	RESISTOR; 0402; 10K OHM; 5%; 200PPM; 0.063W; THICK FILM
R21	-	1	ERJ-14YJ102	PANASONIC	1K	RESISTOR; 1210; 1K OHM; 5%; 200PPM; 0.5W; THICK FILM
R22	-	1	CRCW12062K00FK; MCR18E2PF2001	VISHAY DALE;ROHM	2K	RESISTOR; 1206; 2K; 1%; 100PPM; 14W; THICK FILM
R26	-	1	RC0805JR-070RL	YAGEO PHYCOMP	0	RESISTOR; 0805; 0 OHM; 5%; JUMPER; 0.125W; THICK FILM
R33	-	1	CRCW040212K0FK;MCR01MZPF1202	VISHAY DALE;ROHM SEMICONDUCTOR	12K	RESISTOR; 0402; 12K OHM; 1%; 100PPM; 0.0625W; THICK FILM
R35, R36, R38, R39	-	4	ERJ-2CE0R00	PANASONIC	0	RESISTOR; 0402; 0 OHM; 0%; JUMPER; 0.10W; THICK FILM
R37	-	1	CRCW04021M00FK	VISHAY DALE	1M	RESISTOR; 0402; 1M; 1%; 100PPM; 0.0625W; THICK FILM
R40, R41	-	2	CRCW04024K70FK;MCR01MZPF4701	VISHAY DALE;ROHM SEMICONDUCTOR	4.7K	RESISTOR; 0402; 4.7K OHM; 1%; 100PPM; 0.0625W; THICK FILM
R42, R43	-	2	PNM0402E5001BS	VISHAY DALE	5K	RESISTOR; 0402; 5K OHM; 0.1%; 25PPM; 0.05W; THIN FILM
R46, R47	-	2	CRCW0402470RFK	VISHAY DALE	470	RESISTOR; 0402; 470 OHM; 1%; 100PPM; 0.0625W; THICK FILM
RT1-RT4	-	4	NCP15XH103F03	MURATA	10K	THERMISTOR; SMT (0402); THICK FILM (NICKEL PLATED); 10K; TOL=+/-1%
S1, S2	-	2	EVQ-Q2K03W	PANASONIC	EVQ-Q2K03W	SWITCH; SPST; SMT; 15V; 0.02A; LIGHT TOUCH SWITCH; RCOL= OHM; RINSULATION= OHM; PANASONIC
T1	-	1	TGM-040P3RL	HALO ELECTRONICS INC	TGM-040P3RL	TRANSFORMER; SMT; 1:1-1.3-1.3; PCMCIA DC/DC CONVERTER ;
U1	-	1	See Ordering Information	MAXIM		POPULATED EVKIT PART - IC; MAX17320X+; PACKAGE CODE: W3002+1; PACKAGE OUTLINE NUMBER: 21-100381
U2	-	1	FT2232HL	FUTURE TECHNOLOGY DEVICES INTL. LTD.	FT2232HL	IC; MMRY; DUAL HIGH SPEED USB TO MULTIPURPOSE UART/IF/IO; LQFP64
U3	-	1	MAX14937AWE+	MAXIM	MAX14937AWE+	IC; ISRO; TWO CHANNEL; 5KVRMS IZC ISOLATOR; WSOIC16
U4	-	1	MAX13253ATB+	MAXIM	MAX13253ATB+	IC; DRV; 1A SPREAD-SPECTRUM; PUSH-PULL; TRANSFORMER DRIVER FOR ISOLATED POWER SUPPLIES; TDFN10-EP
U5, U6	-	2	MAX8511EXK33+	MAXIM	MAX8511EXK33+	IC; VREG; ULTRA-LOW-NOISE; HIGH PSRR; LOW-DROPOUT; LINEAR REGULATOR; SC70-5
Y1	-	1	7M-12.000MAAJ	TXC CORPORATION	12MHZ	CRYSTAL; SMT; 18PF; 12MHZ; +/-30PPM; +/-30PPM
PCB	-	1	MAX17320XSOLDERDOWN	MAXIM	PCB	PCB;MAX17320XSOLDERDOWN
C16-C18	DNP	0	GRM1555C1E102JA01;C1005C0G1E102J05BA	MURATA;TDK	1000PF	CAPACITOR; SMT (0402); CERAMIC CHIP; 1000PF; 25V; TOL=5%; TG=-55 DEGC TO +125 DEGC; TC=C0G
J3	DNP	0	PBC04DAAN	SULLINS ELECTRONICS CORP.	PBC04DAAN	CONNECTOR; MALE; THROUGH HOLE; BREAKAWAY; STRAIGHT; 8PINS; -65 DEGC TO +125 DEGC
Q3	DNP	0	FDPC4044	ON SEMICONDUCTOR	FDPC4044	TRAN; COMMON DRAIN N-CHANNEL POWER/TRENCH MOSFET; NCH; POWERCLIP-3; PD-(2.7W); I-(27A); V-(30V)
C44	DNP	0	N/A	N/A	N/A	CAPACITOR; SMT (0402); OPEN; FORMFACTOR
R7	DNP	0	N/A	N/A	OPEN	RESISTOR; 0805; OPEN; FORMFACTOR
R23, R24, R50	DNP	0	N/A	N/A	OPEN	RESISTOR; 0402; OPEN; FORMFACTOR

MAX17320X EV Kit Schematic

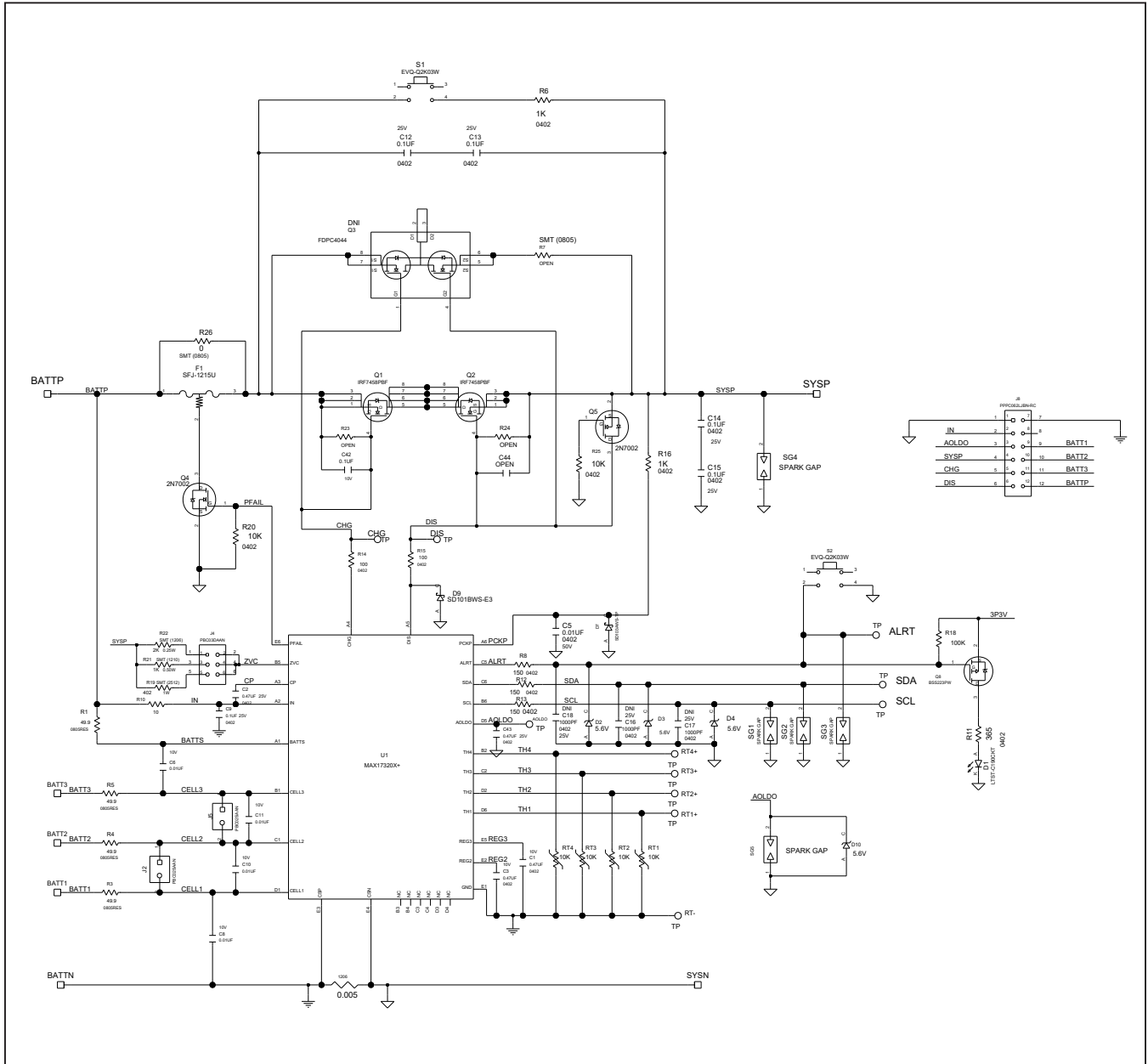

MAX17320X EV Kit Schematic (continued)

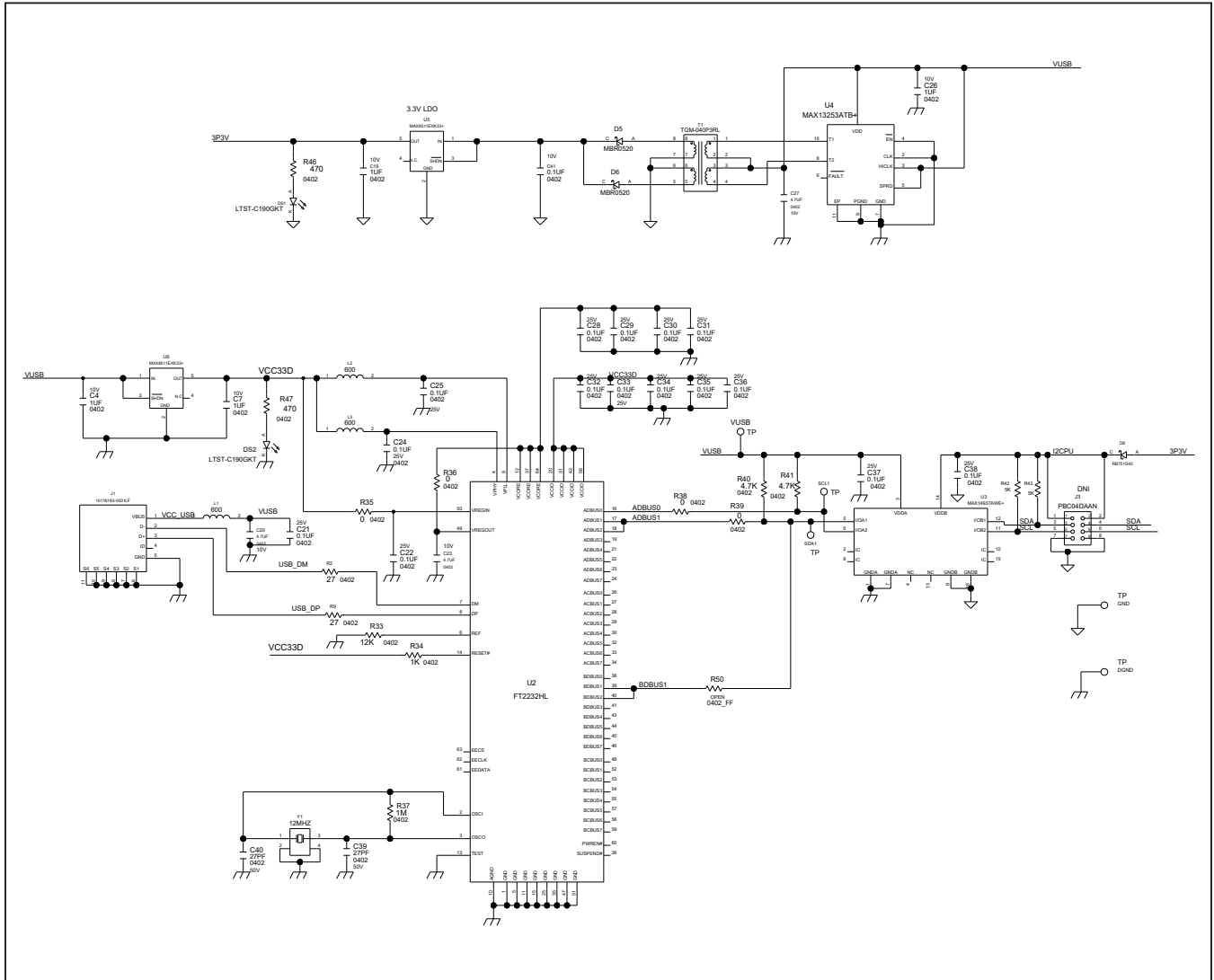

MAX17320X/MAX17320G Evaluation Kits

Evaluate: MAX17320

MAX17320X EV Kit PCB Layouts

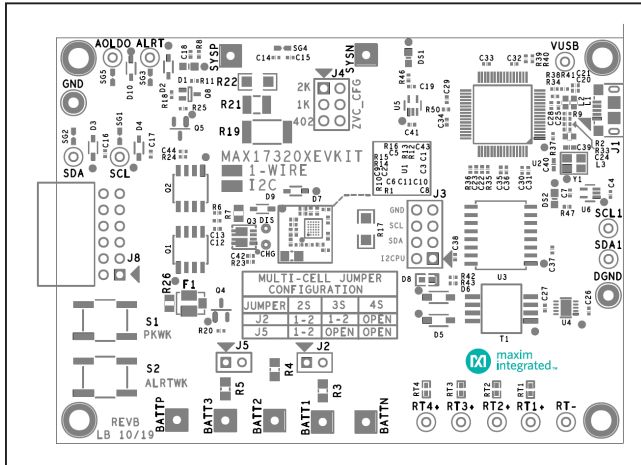

MAX17320X EV Kit Component Placement Guide—Top Silkscreen

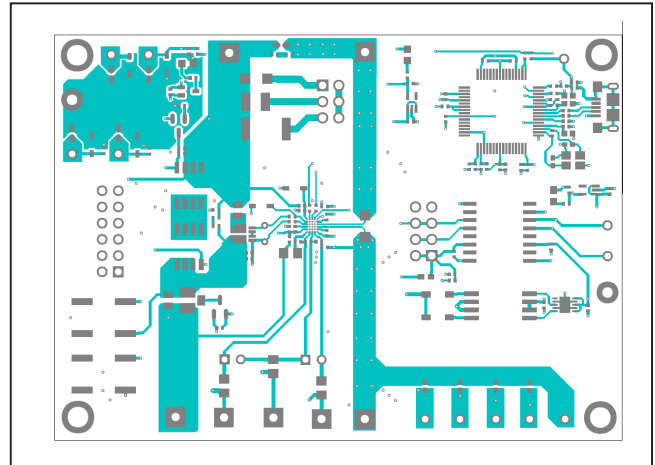

MAX17320X EV Kit PCB Layout—Top Layer

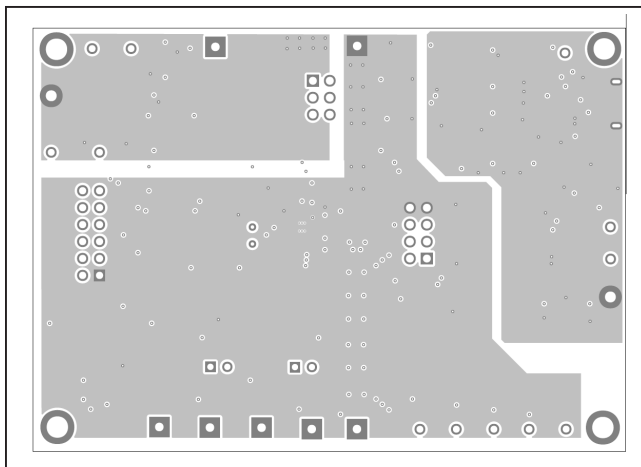

MAX17320X EV Kit PCB Layout—Layer 2

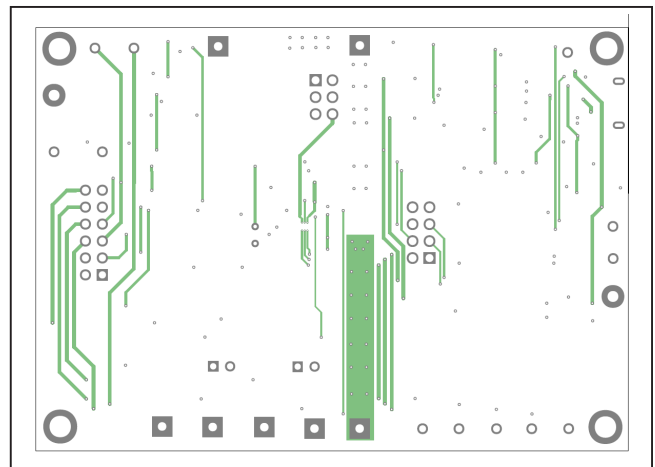

MAX17320X EV Kit PCB Layout—Layer 3



MAX17320X EV Kit PCB Layout—Bottom Layer

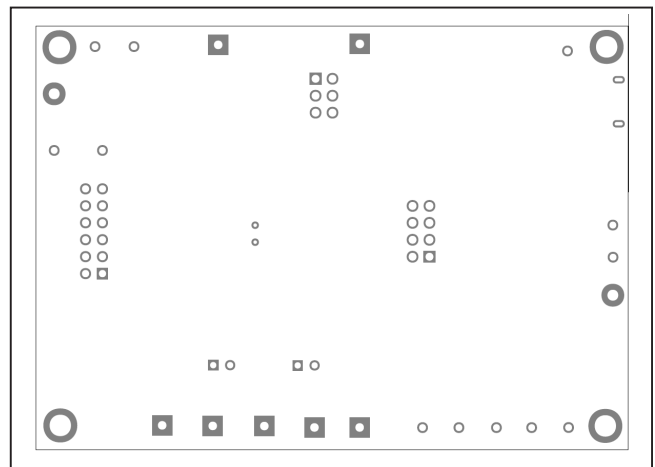

MAX17320X EV Kit Component Placement Guide—Bottom Silkscreen

MAX17320X/MAX17320G Evaluation Kits

Evaluate: MAX17320

MAX17320G EV Kit Bill of Materials

REF_DES	QTY	MFG PART #	MANUFACTURER	VALUE	DESCRIPTION
ALRT, AOLDO, RT-, RT1+-RT4+, SCL, SCL1, SDA, SDA1, VUSB	-	12 5002	KEYSTONE	N/A	TEST POINT; PIN DIA=0.1IN; TOTAL LENGTH=0.3IN; BOARD HOLE=0.04IN; WHITE; PHOSPHOR BRONZE WIRE SILVER;
C1, C3	-	2 LMK105B7474KV	PANASONIC	0.47UF	CAPACITOR; SMT (0402); CERAMIC CHIP; 0.47UF; 10V; TOL=10%; TG=-55 DEGC TO +125 DEGC; TC=X7R
C2, C43	-	2 C1005X5R1E474K050;GRT155R61E474KE01	TDK;MURATA	0.47UF	CAPACITOR; SMT (0402); CERAMIC CHIP; 0.47UF; 25V; TOL=10%; TG=-55 DEGC TO +85 DEGC; TC=X5R
C4, C7, C19, C26	-	4 C0402C105K8PAC;C0402KRXSR6BB105	KEMET;YAGEO	1UF	CAPACITOR; SMT (0402); CERAMIC CHIP; 1UF; 10V; TOL=10%; TG=-55 DEGC TO +85 DEGC; TC=X5R
C5	-	1 C0402C103K5RAC;GRM155R71H103K488;C1005X7R1H103K050BE;CL05B103K85NN;UMK105B7103KV	KEMET;MURATA;TDK;SAMSUNG ELECTRONIC;TAIYO YUDEN	0.01UF	CAPACITOR; SMT (0402); CERAMIC CHIP; 0.01UF; 50V; TOL=10%; TG=-55 DEGC TO +125 DEGC; TC=X7R
C6, C8, C10, C11	-	4 CL05B103KP5NN	SAMSUNG ELECTRONICS	0.01UF	CAPACITOR; SMT (0402); CERAMIC; 0.01UF; 10V; TOL=10%; TG=-55 DEGC TO +125 DEGC; TC=X7R
C9, C12-C15, C21, C22, C24, C25, C28-C38	-	20 GRM155R71E104KE14;C1005X7R1E104K050BB;TMM105B7104KXV;CJ2B3X7R1E104K050BB	MURATA;TDK;TAIYO YUDEN;TDK	0.1UF	CAPACITOR; SMT (0402); CERAMIC CHIP; 0.1UF; 25V; TOL=10%; MODEL=GRM SERIES; TG=-55 DEGC TO +125 DEGC; TC=X7R
C20, C23, C27	-	3 ZR815XR91A475ME01; CL05A475MPPN9N;GRM155R61A475MEA;C1005X5R1A475M050BC	MURATA;SAMSUNG;MURATA;TDK	4.7UF	CAPACITOR; SMT (0402); CERAMIC CHIP; 4.7UF; 10V; TOL=5%; TG=-55 DEGC TO +85 DEGC; TC=X5R
C39, C40	-	2 C0402C0G500270JNP; GRM1555C1H270JA01	VENKEL LTD.;MURATA	27PF	CAPACITOR; SMT; 0402; CERAMIC; 27PF; 50V; 5%; C0G; -55degC to +125degC; 0 +/-30PPM/degC
C41, C42	-	2 GRM155R71A104JA01	MURATA	0.1UF	CAPACITOR; SMT (0402); CERAMIC CHIP; 0.1UF; 10V; TOL=5%; TG=-55 DEGC TO +125 DEGC; TC=X7R
D1	-	1 LTST-C190CKT	LITE-ON ELECTRONICS INC.	LTST-C190CKT	DIODE; LED; STANDARD; RED; SMT (0603); PIV=5.0V; IF=0.04A; -55 DEGC TO +85 DEGC
D2-D4, D10	-	4 BZX384-C5V6	NXP	5.6V	DIODE; ZNR; SMT (SOD-323); Vz=5.6V; Izm=0.000001A; -65 DEGC TO +150 DEGC
D5, D6	-	2 MBR0520	MICRO COMMERCIAL COMPONENTS	MBR0520	DIODE; SCH; SCHOTTKY RECTIFIER; SMT (SOD-123); PIV=20V; IF=0.5A; -55 DEGC TO +150 DEGC
D7	-	1 SD103AWS	MICRO COMMERCIAL COMPONENTS	SD103AWS-TP	DIODE; SCH; SMALL SIGNAL SCHOTTKY DIODE; SOD-323; PIV=40V; IF=0.35A
D8	-	1 RB751S40	FAIRCHILD SEMICONDUCTOR	RB751S40	DIODE; SCH; SMT (SOD-523F); PIV=40V; IF=0.03A
D9	-	1 SD101BWS-E3	VISHAY	SD101BWS-E3	DIODE; SCH; SMT (SOD-323); PIV=50V; IF=0.03A
DGND, GND	-	2 5011	KEYSTONE	N/A	TEST POINT; PIN DIA=0.125IN; TOTAL LENGTH=0.445IN; BOARD HOLE=0.063IN; BLACK; PHOSPHOR BRONZE WIRE SILVER PLATE FINISH;
DS1, DS2	-	2 LTST-C190GKT	LITE-ON ELECTRONICS INC.	LTST-C190GKT	DIODE; LED; WATER CLEAR GREEN; SMT (0603); VF=2.1V; IF=0.03A; -55 DEGC TO +85 DEGC
F1	-	1 SFJ-1215U	DEXERIALS	SFJ-1215U	EVKIT PART - FUSE; SELF CONTROL PROTECTOR; SFJ SERIES; 3-CELL; 15A
J1	-	1 10118193-0001LF	FCI CONNECT	10118193-0001LF	CONNECTOR; FEMALE; SMT; MICRO USB B TYPE RECEPTACLE; RIGHT ANGLE; 5PINS
J2, J5	-	2 PBC02SAAN	SULLINS ELECTRONICS CORP.	PBC02SAAN	EVKIT PART-CONNECTOR; MALE; THROUGH HOLE; BREAKAWAY; STRAIGHT; 2PINS; -65 DEGC TO +125 DEGC;
J4	-	1 PBC03DAAN	SULLINS ELECTRONICS CORP.	PBC03DAAN	CONNECTOR; MALE; THROUGH HOLE; BREAKAWAY; STRAIGHT; 6PINS; -65 DEGC TO +125 DEGC
J8	-	1 PPPC062LJBN-RC	SULLINS ELECTRONICS CORP.	PPPC062LJBN-RC	CONNECTOR; FEMALE; THROUGH HOLE; 0.1IN CC; HEADER; 2 ROW; RIGHT ANGLE; 12PINS
L1-L3	-	3 BLM18AG801SN1	MURATA	800	INDUCTOR; SMT (0603); FERRITE-BEAD; 800; TOL=+/-; 0.5A
MISC1	-	1 AK67421-1-R	ASSMANN	AK67421-1-R	CONNECTOR; MALE; USB; USB2.0 MICRO CONNECTION CABLE; USB B MICRO MALE TO USB A MALE; STRAIGHT; 5PINS-4PINS
Q1, Q2	-	2 IRF7458PBF	INFINEON	IRF7458PBF	TRAN; SMPS MOSFET; NCH; NSOIC8; PD-(2.5W); I(14A); V-(30V)
Q4, Q5	-	2 2N7002	NXP	2N7002	TRAN; N-CHANNEL TRENCH MOSFET; NCH; SOT-23; PD-(0.83W); I(0.3A); V-(60V)
Q8	-	1 BSS223PW	INFINEON	BSS223PW	TRAN; OPTIMOS SMALL-SIGNAL-TRANSISTOR; PCH; SOT323-3; PD-(0.25W); I(-0.39A); V(-20V)
R1, R3-R5	-	4 RNC0805FTD49R9	STACKPOLE ELECTRONICS INC	49.9	RESISTOR; 0805; 49.9 OHM; 1%; 100PPM; 0.25W; THIN FILM
R2, R9	-	2 ERJ-2RKF27R0X;RC0402FR-0727R; CRCW0402Z27R0FK; CRCW04021K00FK; RC0402FR-071K;MCR01MZPF1001	PANASONIC;YAGEO PHICOMP;VISHAY DALE	27	RESISTOR; 0402; 27 OHM; 1%; 100PPM; 0.0625W; THICK FILM
R6, R16, R34	-	3 CRCW0402150RFK; 9C04021A1500FL	VISHAY DALE;YAGEO	150	RESISTOR; 0402; 150 OHM; 1%; 100PPM; 0.0625W; THICK FILM
R8, R12, R13	-	3 CRCW0402150RFK; 9C04021A1500FL	VISHAY DALE;YAGEO	150	RESISTOR; 0402; 150 OHM; 1%; 100PPM; 0.0625W; THICK FILM
R10	-	1 RT0402BRD0710RL	YAGEO	10	RES; SMT (0402); 10; 0.1%; +/-25PPM/DEGC; 0.063W
R11	-	1 CR0402-16W-3650FT	VENKEL LTD.	365	RESISTOR; 0402; 365 OHM; 1%; 100PPM; 0.063W; THICK FILM
R14, R15	-	2 CRCW0402100RFK; 9C04021A1000FL; RC0402FR-07100RL	VISHAY DALE;PANASONIC;YAGEO PHYCOMP	100	RESISTOR; 0402; 100 OHM; 1%; 100PPM; 0.063W; THICK FILM
R17	-	1 WSLP1206S1000F	VISHAY DALE	0.005	RESISTOR; 1206; 0.005 OHM; 1%; 400PPM; 1.0W; METAL FILM
R18	-	1 CRCW0402100FK;RC0402FR-07100KL	VISHAY;YAGEO	100K	RESISTOR; 0402; 100K; 1%; 100PPM; 0.0625W; THICK FILM
R19	-	1 ERJ-1TNF4020U;CRCW2512402RFK	PANASONIC;VISHAY DALE	402	RESISTOR; 2512; 402 OHM; 1%; 100PPM; 1.0W; THICK FILM
R20, R25	-	2 CRCW040210KJN	VISHAY DALE	10K	RESISTOR; 0402; 10K OHM; 5%; 200PPM; 0.063W; THICK FILM
R21	-	1 ERJ-14Y1J02	PANASONIC	1K	RESISTOR; 1210; 1K OHM; 5%; 200PPM; 0.5W; THICK FILM
R22	-	1 CRCW12062K00FK; MCR18E2PF2001	VISHAY DALE;ROHM	2K	RESISTOR; 1206; 2K; 1%; 100PPM; 1/4W; THICK FILM
R26	-	1 RC0805JR-070RL	YAGEO PHYCOMP	0	RESISTOR; 0805; 0 OHM; 5%; JUMPER; 0.125W; THICK FILM
R33	-	1 CRCW040212K0FK;MCR01MZPF1202	VISHAY DALE;ROHM SEMICONDUCTOR	12K	RESISTOR; 0402; 12K OHM; 1%; 100PPM; 0.0625W; THICK FILM
R35, R36, R38, R39	-	4 ERJ-2GED0R0	PANASONIC	0	RESISTOR; 0402; 0 OHM; 0%; JUMPER; 0.10W; THICK FILM
R37	-	1 CRCW04021M00FK	VISHAY DALE	1M	RESISTOR; 0402; 1M; 1%; 100PPM; 0.0625W; THICK FILM
R40, R41	-	2 CRCW04024K70FK;MCR01MZPF4701	VISHAY DALE;ROHM SEMICONDUCTOR	4.7K	RESISTOR; 0402; 4.7K OHM; 1%; 100PPM; 0.0625W; THICK FILM
R42, R43	-	2 PNM0402E5001B5	VISHAY DALE	5K	RESISTOR; 0402; 5K OHM; 0.1%; 25PPM; 0.05W; THIN FILM
R46, R47	-	2 CRCW0402470RFK	VISHAY DALE	470	RESISTOR; 0402; 470 OHM; 1%; 100PPM; 0.0625W; THICK FILM
RT1-RT4	-	4 NCP15XH103F03	MURATA	10K	THERMISTOR; SMT (0402); THICK FILM (NICKEL PLATED); 10K; TOL=+/-1%
S1, S2	-	2 EVQ-Q2K03W	PANASONIC	EVQ-Q2K03W	SWITCH; SPST; SMT; 15V; 0.02A; LIGHT TOUCH SWITCH; RC0L= OHM; RINSULATION= OHM; PANASONIC
T1	-	1 TGM-040P3RL	HALO ELECTRONICS INC	TGM-040P3RL	TRANSFORMER; SMT; 1:1; 1:1; 3:1; 3:1; PCMCIA DCDC CONVERTER ;
U1	-	1 See Ordering Information	MAXIM		EVKIT PART - IC; MAX17320G+; PACKAGE CODE: T2444+4C; PACKAGE OUTLINE NUMBER: 21-21-0139
U2	-	1 FT232HL	FUTURE TECHNOLOGY DEVICES INTL LTD.	FT232HL	IC; MMRY; DUAL HIGH SPEED USB TO MULTIPURPOSE UART/FIFO; LQFP64
U3	-	1 MAX14937AWE+	MAXIM	MAX14937AWE+	IC; ISO; TWO CHANNEL; 5KVRMS I2C ISOLATOR; WSOIC16
U4	-	1 MAX13253ATB+	MAXIM	MAX13253ATB+	IC; DRV; 1A SPREAD-SPECTRUM; PUSH-PULL; TRANSFORMER DRIVER FOR ISOLATED POWER SUPPLIES; TDFN10-EP
U5, U6	-	2 MAX8511EXK33+	MAXIM	MAX8511EXK33+	IC; VREG; ULTRA-LOW-NOISE; HIGH PSRR; LOW DROPOUT; LINEAR REGULATOR; SC70-5
Y1	-	1 7M-12.000MAJ	TXC CORPORATION	12MHZ	CRYSTAL; SMT; 18PF; 12MHZ; +/-30PPM; +/-30PPM
PCB	-	1 MAX17320XSOLDERDOWN	MAXIM	PCB	PCB;MAX17320XSOLDERDOWN
C16-C18	DNP	0 GRM1555C1E102JA01;C1005CG1E102J050BA	MURATA;TDK	1000PF	CAPACITOR; SMT (0402); CERAMIC CHIP; 1000PF; 25V; TOL=5%; TG=-55 DEGC TO +125 DEGC; TC=X5G
J3	DNP	0 PBC04DAAN	SULLINS ELECTRONICS CORP.	PBC04DAAN	CONNECTOR; MALE; THROUGH HOLE; BREAKAWAY; STRAIGHT; 8PINS; -65 DEGC TO +125 DEGC
Q3	DNP	0 FDP4044	ON SEMICONDUCTOR	FDP4044	TRAN; COMMON DRAIN N-CHANNEL POWERTRENCH MOSFET; NCH; POWERCLIP-33; PD-(2.7W); I(27A); V-(30V)
C44	DNP	0 N/A	N/A	OPEN	CAPACITOR; SMT (0402); OPEN; FORMFACTOR
R7	DNP	0 N/A	N/A	OPEN	RESISTOR; 0805; OPEN; FORMFACTOR
R23, R24, R50	DNP	0 N/A	N/A	OPEN	RESISTOR; 0402; OPEN; FORMFACTOR

MAX17320G EV Kit PCB Schematics

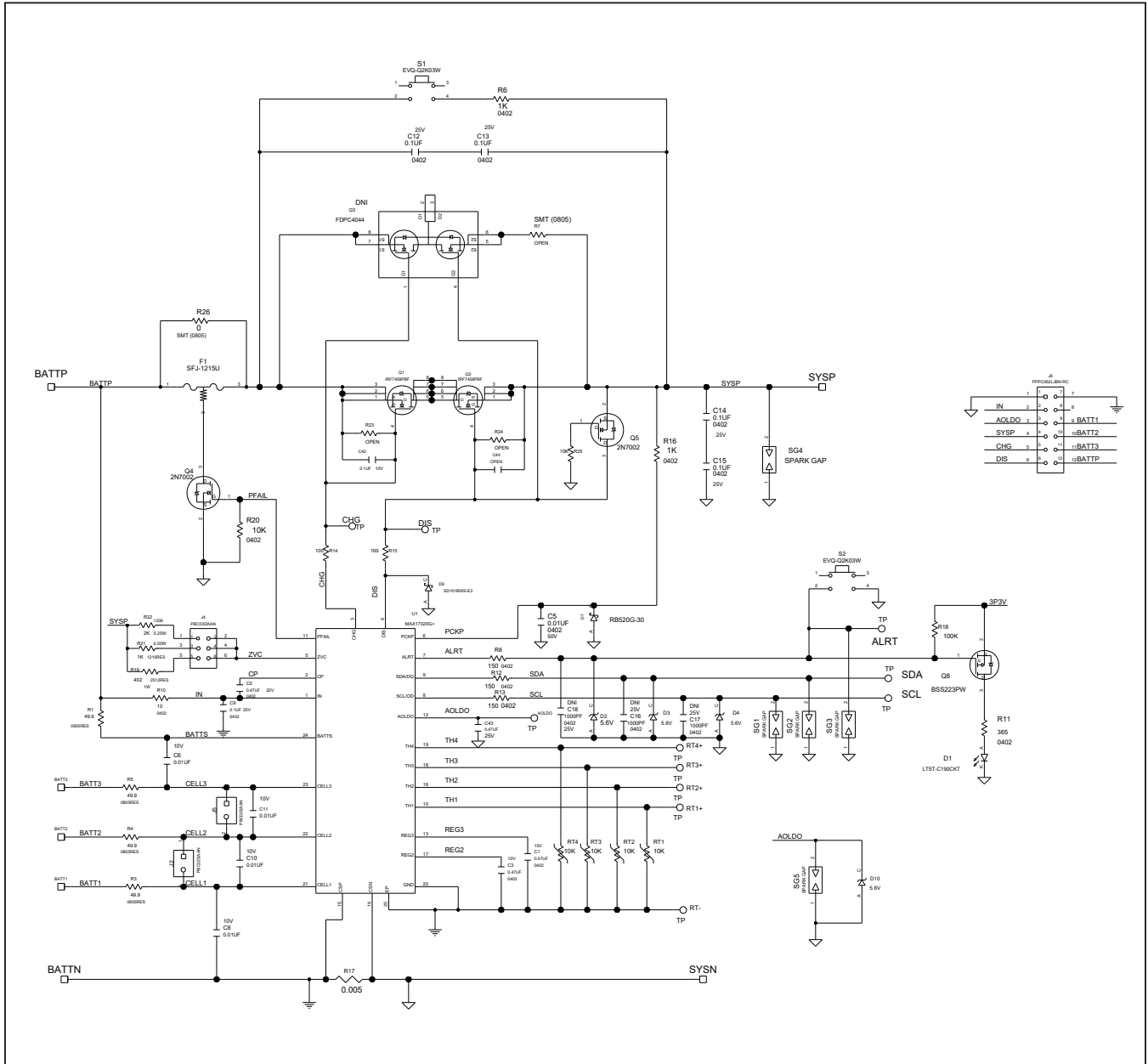

MAX17320G EV Kit PCB Schematics (continued)

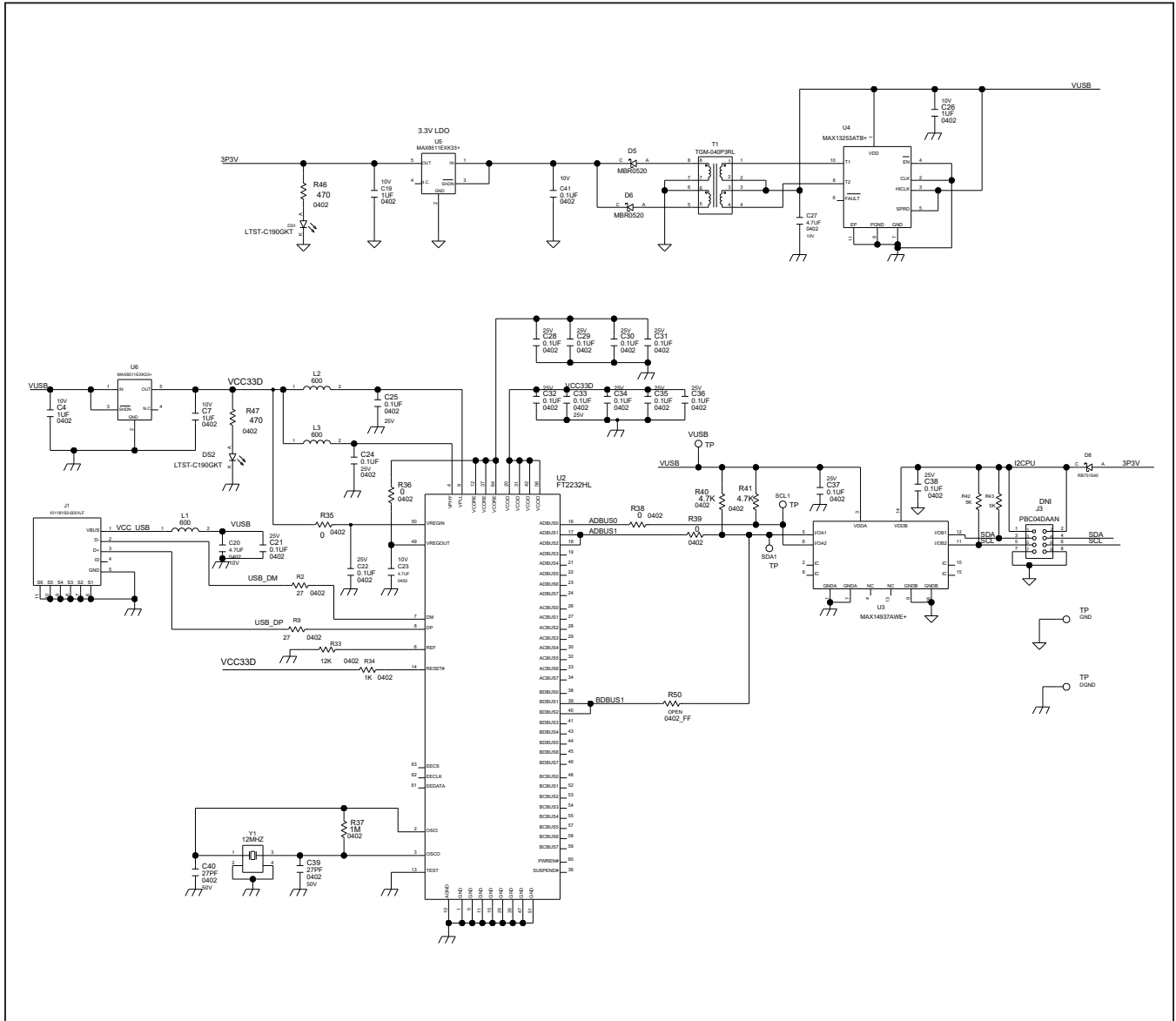

MAX17320X/MAX17320G Evaluation Kits

Evaluate: MAX17320

MAX17320G EV Kit PCB Layouts

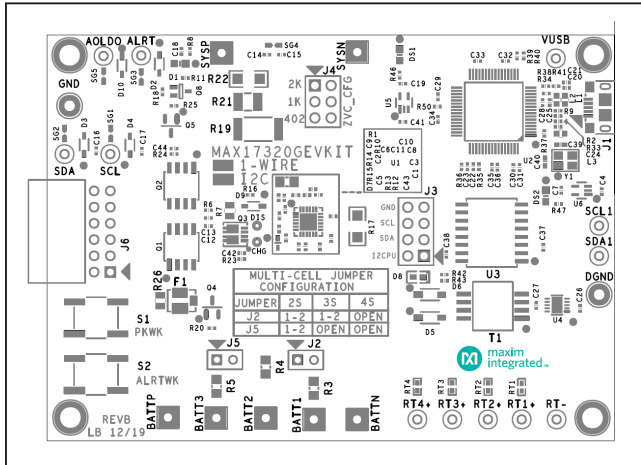

MAX17320G EV Kit Component Placement Guide—Top Silkscreen

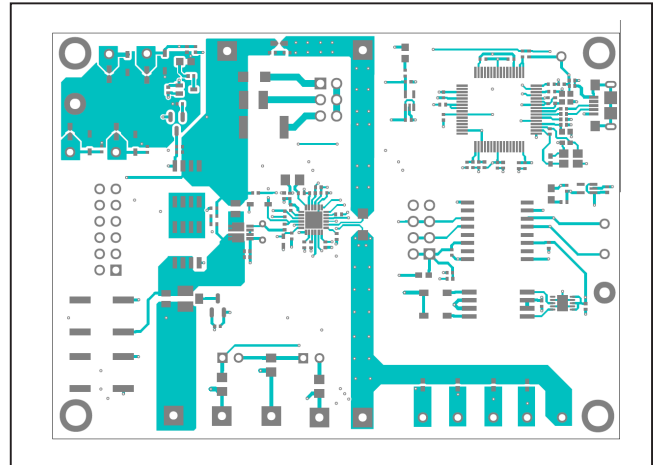

MAX17320G EV Kit PCB Layout—Top Layer

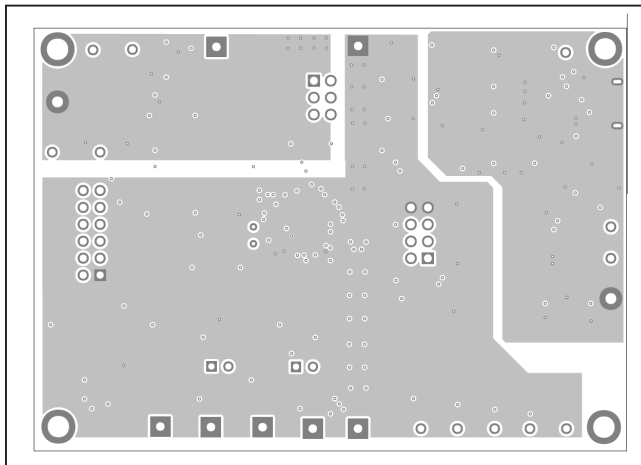

MAX17320G EV Kit PCB Layout—Layer 2

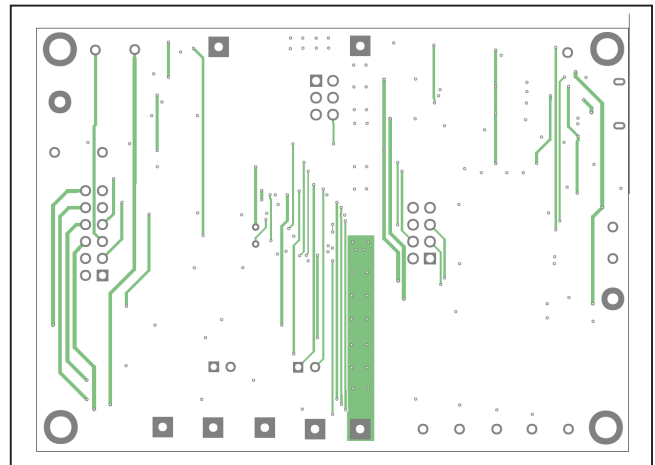

MAX17320G EV Kit PCB Layout—Layer 3

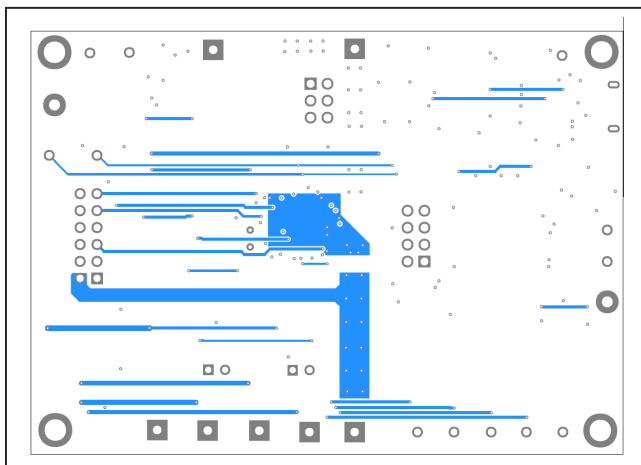

MAX17320G EV Kit PCB Layout—Bottom Layer

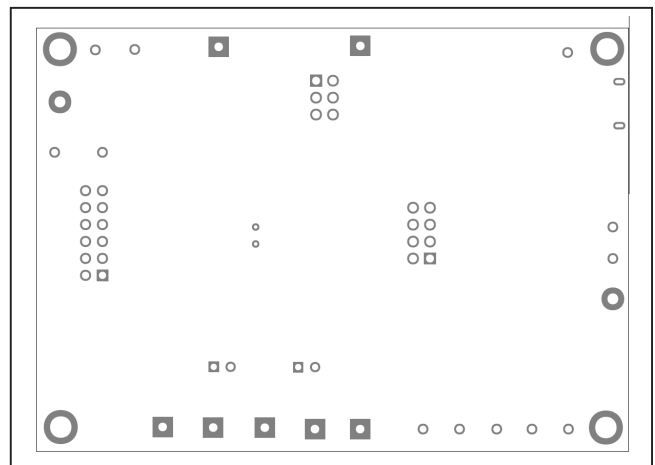

MAX17320G EV Kit Component Placement Guide—Bottom Silkscreen

Revision History

REVISION NUMBER	REVISION DATE	DESCRIPTION	PAGES CHANGED
0	3/20	Initial release	—
1	4/20	Updated <i>Ordering Information</i> table	24
2	7/20	Updated <i>General Description</i> section, <i>Configuration Wizard</i> section, and <i>ordering information</i> table, replaced MAX17320X EV kit schematic and MAX17320G EV kit schematic	1, 19–21, 24, 26, 27, 30, 31

For pricing, delivery, and ordering information, please visit Maxim Integrated's online storefront at <https://www.maximintegrated.com/en/storefront/storefront.html>.

Maxim Integrated cannot assume responsibility for use of any circuitry other than circuitry entirely embodied in a Maxim Integrated product. No circuit patent licenses are implied. Maxim Integrated reserves the right to change the circuitry and specifications without notice at any time.