

LP8758-EA Four 4-A Output Synchronous Step-Down DCDC Converters

1 Features

- Fully integrated quad buck, up to 4-A programmable maximum output current per buck
 - Auto PWM-PFM and forced-PWM operations
 - Programmable output voltage slew rate from 30 mV/μs to 0.5 mV/μs
 - Input voltage range: 2.5 V to 5.5 V
 - V_{OUT} range: 0.5 V to 3.36 V with DVS
- Programmable start-up and shutdown sequencing with enable signal
- I²C-compatible interface that supports standard (100 kHz), fast (400 kHz), fast+ (1 MHz), and high-speed (3.4 MHz) modes
- Interrupt function with programmable masking
- Load current measurement
- Output short-circuit and overload protection
- Spread-spectrum mode for EMI reduction
- The four buck cores operate 90° out of phase thereby reducing input ripple current
- Overtemperature warning and protection
- Undervoltage Lockout (UVLO)

2 Applications

- Optical modules
- Drone systems
- Smart phones, eBooks, and tablets
- Solid state drives

3 Description

The LP8758-EA device is designed to meet power management requirements for low-power processors in mobile phones, network cards, and similar applications. The device contains four step-down DC-DC converter cores, providing four output voltage rails. The device is controlled by an I²C-compatible serial interface.

The automatic PWM-PFM (AUTO mode) operation maximizes efficiency over a wide output-current range.

The LP8758-EA supports programmable start-up and shutdown sequencing synchronized to hardware Enable input signal.

The protection features include short-circuit protection, current limits, input supply UVLO, and temperature warning and shutdown functions. Several error flags are provided for status information of the device. In addition, the LP8758-EA device supports load current measurement without the addition of external current sense resistors. During start-up and voltage change, the device controls the output slew rate to minimize output voltage overshoot and the inrush current.

Device Information⁽¹⁾

PART NUMBER	DEFAULT OUTPUT VOLTAGE	
LP8758-EA	V _{OUT0}	800 mV
	V _{OUT1}	800 mV
	V _{OUT2}	800 mV
	V _{OUT3}	800 mV

- (1) For all available packages, see the orderable addendum at the end of the data sheet.

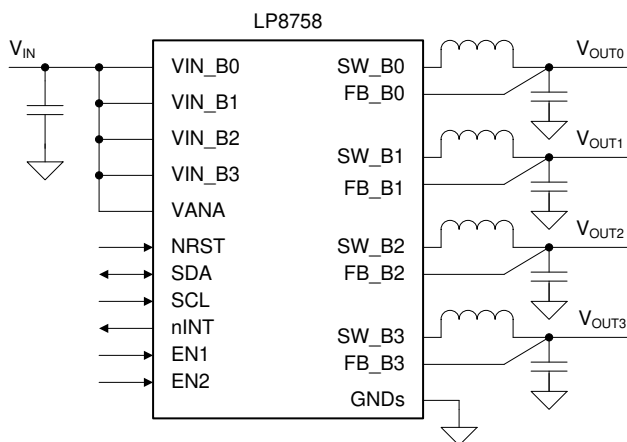

Simplified Schematic

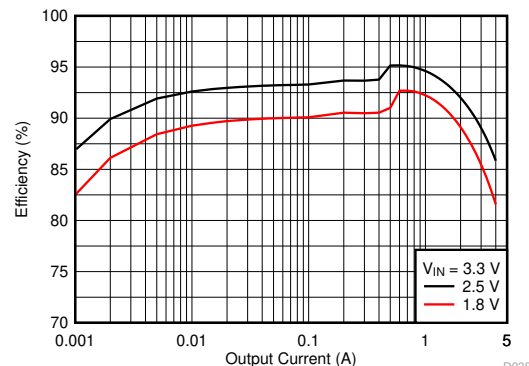

V_{OUT} settings = 1.8 V and 2.5 V

Efficiency vs Output Current

D038



Table of Contents

1 Features	1	7.5 Programming.....	23
2 Applications	1	7.6 Register Maps.....	26
3 Description	1	8 Application and Implementation	46
4 Revision History	2	8.1 Application Information.....	46
5 Pin Configuration and Functions	3	8.2 Typical Application.....	46
6 Specifications	5	9 Power Supply Recommendations	53
6.1 Absolute Maximum Ratings.....	5	10 Layout	54
6.2 ESD Ratings.....	5	10.1 Layout Guidelines.....	54
6.3 Recommended Operating Conditions.....	5	10.2 Layout Example.....	55
6.4 Thermal Information.....	6	11 Device and Documentation Support	56
6.5 Electrical Characteristics.....	6	11.1 Device Support.....	56
6.6 I ² C Serial Bus Timing Requirements.....	8	11.2 Documentation Support.....	56
6.7 Switching Characteristics.....	10	11.3 Receiving Notification of Documentation Updates..	56
6.8 Typical Characteristics.....	11	11.4 Support Resources.....	56
7 Detailed Description	12	11.5 Trademarks.....	56
7.1 Overview.....	12	11.6 Electrostatic Discharge Caution.....	56
7.2 Functional Block Diagram.....	13	11.7 Glossary.....	56
7.3 Feature Description.....	13	12 Mechanical, Packaging, and Orderable	
7.4 Device Functional Modes.....	22	Information	57

4 Revision History

NOTE: Page numbers for previous revisions may differ from page numbers in the current version.

DATE	REVISION	NOTES
April 2021	*	Initial Release

5 Pin Configuration and Functions

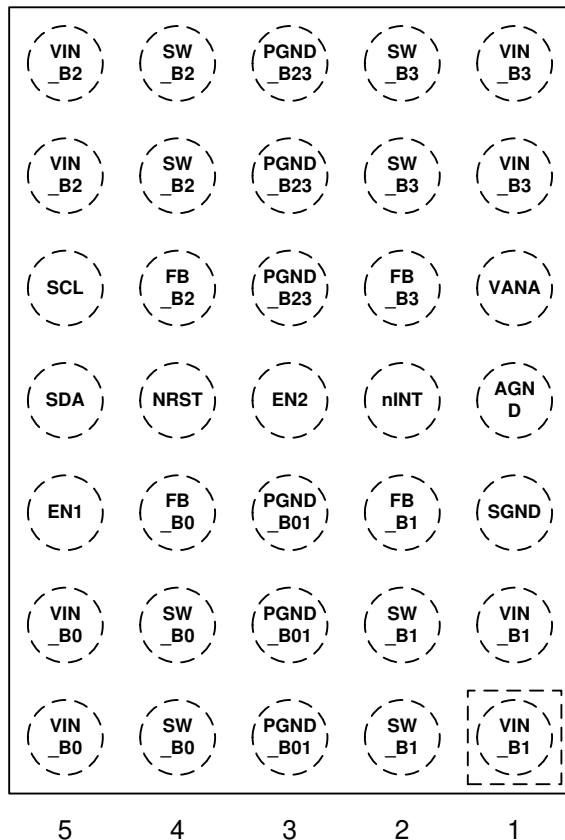

Figure 5-1. YFF Package 35-Pin DSBGA Top View

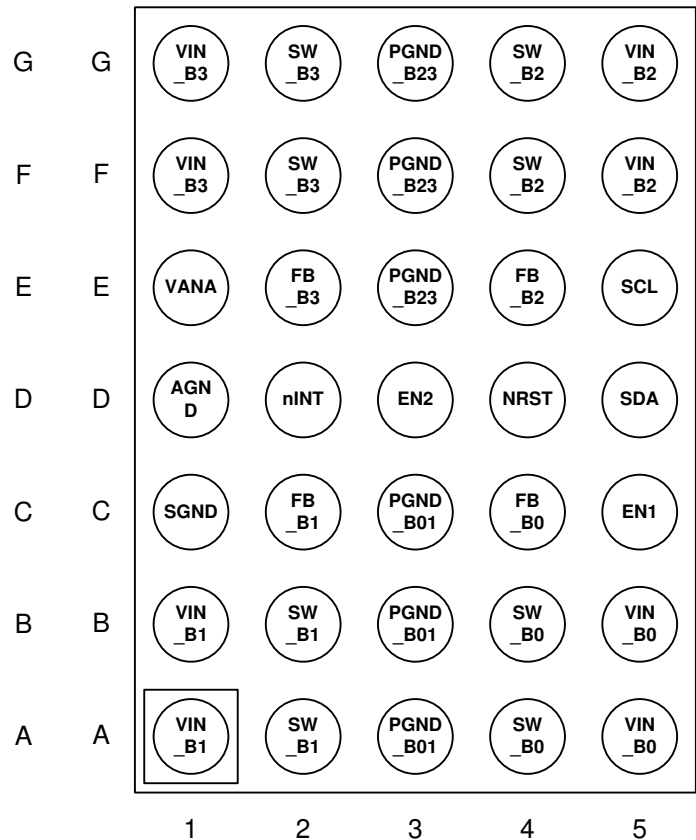

Figure 5-2. YFF Package 35-Pin DSBGA Bottom View

Table 5-1. Pin Functions

PIN		TYPE	DESCRIPTION
NO.	NAME		
A1, B1	VIN_B1	P	Input for Buck1. The separate power pins VIN_Bx are not connected together internally – VIN_Bx pins must be connected together in the application and be locally bypassed.
A2, B2	SW_B1	A	Buck1 switch node.
A3, B3, C3	PGND_B01	G	Power Ground for Buck0 and Buck1.
A4, B4	SW_B0	A	Buck0 switch node.
A5, B5	VIN_B0	P	Input for Buck0. The separate power pins VIN_Bx are not connected together internally – VIN_Bx pins must be connected together in the application and be locally bypassed.
C1	SGND	G	Substrate Ground.
C2	FB_B1	A	Output voltage feedback for Buck1.
C4	FB_B0	A	Output voltage feedback for Buck0.
C5	EN1	D/I	Programmable Enable signal for Buck converter core or cores. Can be also configured to switch between two output voltage levels.
D1	AGND	G	Ground.
D2	nINT	D/O	Open-drain interrupt output. Active LOW.
D3	EN2	D/I	Programmable Enable signal for Buck converter one or more cores. Can be also configured to switch between two output voltage levels.
D4	NRST	D/I	Reset signal for the device. Can be also used to enable the regulator.
D5	SDA	D/I/O	Serial interface data input and output for system access. Connect a pullup resistor.

Table 5-1. Pin Functions (continued)

PIN		TYPE	DESCRIPTION
NO.	NAME		
E1	VANA	P	Supply voltage for Analog and Digital blocks.
E2	FB_B3	A	Output voltage feedback for Buck3.
E4	FB_B2	A	Output voltage feedback for Buck2.
E5	SCL	D/I	Serial interface clock input for system access. Connect a pullup resistor.
F1, G1	VIN_B3	P	Input for Buck3. The separate power pins VIN_Bx are not connected together internally – VIN_Bx pins must be connected together in the application and be locally bypassed.
F2, G2	SW_B3	A	Buck3 switch node.
E3, F3, G3	PGND_B23	G	Power Ground for Buck2 and Buck3.
F4, G4	SW_B2	A	Buck2 switch node.
F5, G5	VIN_B2	P	Input for Buck2. The separate power pins VIN_Bx are not connected together internally - VIN_Bx pins must be connected together in the application and be locally bypassed.

A: Analog Pin, D: Digital Pin, G: Ground Pin, P: Power Pin, I: Input Pin, O: Output Pin

6 Specifications

6.1 Absolute Maximum Ratings

Over operating free-air temperature range (unless otherwise noted).^{(1) (2)}

		MIN	MAX	UNIT
INPUT VOLTAGE				
VIN_Bx, VANA	Voltage on power connections	-0.3	6	V
SW_Bx	Voltage on buck switch nodes	-0.3	(VIN_Bx + 0.3 V) with 6 V maximum	V
FB_Bx	Voltage on buck voltage sense nodes	-0.3	(VANA + 0.3 V) with 6 V maximum	V
NRST	Voltage on NRST input	-0.3	3.6	V
ENx, SDA, SCL, nINT	Voltage on logic pins (input or output pins)	-0.3	3.6	
CURRENT				
VIN_Bx, SW_Bx, PGND_Bx	Current on power pins (average current over 100k hour lifetime, T _J = 125°C)		0.62	A/pin
TEMPERATURE				
T _{J-MAX}	Junction temperature	-40	150	°C
Maximum lead temperature (soldering, 10 seconds) ⁽³⁾			260	°C
T _{stg}	Storage temperature	-65	150	°C

- (1) Stresses beyond those listed under *Absolute Maximum Ratings* may cause permanent damage to the device. These are stress ratings only, which do not imply functional operation of the device at these or any other conditions beyond those indicated under [Section 6.3](#). Exposure to absolute-maximum-rated conditions for extended periods may affect device reliability.
- (2) All voltage values are with respect to network ground.
- (3) For detailed soldering specifications and information, please refer to [DSBGA Wafer Level Chip Scale Package](#).

6.2 ESD Ratings

		VALUE	UNIT
V _(ESD)	Electrostatic discharge	Human-body model (HBM), per ANSI/ESDA/JEDEC JS-001 ⁽¹⁾	±2000
		Charged-device model (CDM), per JEDEC specification JESD22-C101 ⁽²⁾	±500

- (1) JEDEC document JEP155 states that 500-V HBM allows safe manufacturing with a standard ESD control process.
- (2) JEDEC document JEP157 states that 250-V CDM allows safe manufacturing with a standard ESD control process.

6.3 Recommended Operating Conditions

Over operating free-air temperature range (unless otherwise noted).

		MIN	MAX	UNIT
INPUT VOLTAGE				
VIN_Bx, VANA	Voltage on power connections	2.5	5.5	V
NRST	Voltage on NRST	0	VANA with 3.6 V maximum	V
ENx, nINT	Voltage on logic pins (input or output pins)	0	VANA with 3.6 V maximum	V
SCL, SDA	Voltage on I ² C interface, standard (100 kHz), fast (400 kHz), fast+ (1 MHz), and high-speed (3.4 MHz) modes	0	1.95	V
	Voltage on I ² C interface, standard (100 kHz), fast (400 kHz), and fast+ (1 MHz) modes	0	VANA with 3.6 V maximum	V
TEMPERATURE				
T _J	Junction temperature	-40	125	°C
T _A	Ambient temperature	-40	85	°C

6.4 Thermal Information

THERMAL METRIC ⁽¹⁾		LP8758	UNIT
		YFF (DSBGA)	
		35 PINS	
R _{θJA}	Junction-to-ambient thermal resistance	56.1	°C/W
R _{θJCTop}	Junction-to-case (top) thermal resistance	0.2	°C/W
R _{θJB}	Junction-to-board thermal resistance	8.5	°C/W
ψ _{JT}	Junction-to-top characterization parameter	0.9	°C/W
ψ _{JB}	Junction-to-board characterization parameter	8.4	°C/W
R _{θJCbott}	Junction-to-case (bottom) thermal resistance	N/A	°C/W

(1) For more information about traditional and new thermal metrics, see the [Semiconductor and IC Package Thermal Metrics application report](#).

6.5 Electrical Characteristics

Limits apply over the junction temperature range $-40^{\circ}\text{C} \leq T_J \leq +125^{\circ}\text{C}$, specified $V_{(VANA)}$, V_{IN} , $V_{(NRST)}$, V_{OUT} and I_{OUT} range, unless otherwise noted. Typical values are at $T_J = 25^{\circ}\text{C}$, $f_{SW} = 3\text{ MHz}$, $V_{(VANA)} = V_{IN} = 3.7\text{ V}$ and $V_{OUT} = 1\text{ V}$, unless otherwise noted.^{(1) (2)}

PARAMETER	TEST CONDITIONS	MIN	TYP	MAX	UNIT		
EXTERNAL COMPONENTS							
C _{IN}	Input filtering capacitance	Connected from VIN_Bx to PGND_Bx		1.9	10	μF	
C _{OUT}	Output filtering capacitance, local	Capacitance per output voltage rail		10	22	μF	
C _{OUT-TOTAL}	Output capacitance, total (local and remote)	Total output capacitance			50	μF	
ESR _C	Input and output capacitor ESR	[1-10] MHz			2	10	mΩ
L	Inductor	Inductance of the inductor			0.47		μH
		-30%		30%			
DCR _L	Inductor DCR	TDK, VLS252010HBX-R47M			29		mΩ
BUCK REGULATORS							
V _{IN}	Input voltage range	Voltage between VIN_Bx and ground terminals. VANA must be connected to the same supply as VIN_Bx.		2.5	3.7	5.5	V
V _{OUT}	Output voltage	Programmable voltage range		0.5	1	3.36	V
		Step size, $0.5\text{ V} \leq V_{OUT} < 0.73\text{ V}$				10	mV
		Step size, $0.73\text{ V} \leq V_{OUT} < 1.4\text{ V}$				5	
		Step size, $1.4\text{ V} \leq V_{OUT} \leq 3.36\text{ V}$				20	
I _{OUT}	Output current	Output current, $V_{IN} \leq 3\text{ V}$ I _{LIM FWD} programmed to 5 A per phase.				3 ⁽³⁾	A
		Output current, $V_{IN} > 3\text{ V}$, $V_{OUT} \leq 2\text{ V}$ I _{LIM FWD} programmed to 5 A per phase.				4 ⁽³⁾	
		Output current, $V_{IN} > 3\text{ V}$, $V_{OUT} > 2\text{ V}$ I _{LIM FWD} programmed to 5 A per phase.				3.5 ⁽³⁾	
	Dropout voltage	V _{IN} - V _{OUT}		0.7			V
	DC output voltage accuracy, includes voltage reference, DC load and line regulations, process and temperature	Force PWM mode		min (-2%, -20 mV)	max (2%, 20 mV)		
		PFM mode, the average output voltage level is increased by a maximum of 20 mV.		min (-2%, -20 mV)	max (2%, 20 mV) + 20 mV		

6.5 Electrical Characteristics (continued)

Limits apply over the junction temperature range $-40^{\circ}\text{C} \leq T_J \leq +125^{\circ}\text{C}$, specified $V_{(VANA)}$, V_{IN} , $V_{(NRST)}$, V_{OUT} and I_{OUT} range, unless otherwise noted. Typical values are at $T_J = 25^{\circ}\text{C}$, $f_{SW} = 3\text{ MHz}$, $V_{(VANA)} = V_{IN} = 3.7\text{ V}$ and $V_{OUT} = 1\text{ V}$, unless otherwise noted.^{(1) (2)}

PARAMETER		TEST CONDITIONS	MIN	TYP	MAX	UNIT
Ripple		PWM mode, $L = 0.47\ \mu\text{H}$		10		$\text{mV}_{\text{p-p}}$
		PFM mode, $L = 0.47\ \mu\text{H}$		20		
DC _{LNR}	DC line regulation	$I_{OUT} = 1\text{ A}$		± 0.05		%/V
DC _{LDR}	DC load regulation in PWM mode	I_{OUT} from 0 to $I_{OUT(\text{max})}$		0.3%		
T _{LDSR}	Transient load step response	$I_{OUT} = 0\text{ A}$ to 2 A , $T_R = T_F = 400\text{ ns}$, PWM mode, $C_{OUT} = 44\ \mu\text{F}$, $L = 0.47\ \mu\text{H}$		± 55		mV
T _{LNSR}	Transient line response	V_{IN} stepping $3.3\text{ V} \leftrightarrow 3.8\text{ V}$, $T_R = T_F = 10\ \mu\text{s}$, $I_{OUT} = I_{OUT(\text{max})}$		± 15		mV
I _{LIM FWD}	Forward current limit (peak for every switching cycle), per phase	Programmable range	2.5		5	A
		Step size		0.5		
		Accuracy, $3\text{ V} \leq V_{IN} \leq 5.5\text{ V}$, $I_{LIM FWD} = 5\text{ A}$	-5%	7.5%	20%	
		Accuracy, $2.5\text{ V} \leq V_{IN} \leq 3\text{ V}$, $I_{LIM FWD} = 5\text{ A}$	-20%	7.5%	20%	
I _{LIM NEG}	Negative current limit		1.6	2	2.4	A
R _{DS(ON) HS FET}	On-resistance, high-side FET	Between V_{IN_Bx} and SW_Bx pins ($I = 1\text{ A}$)		40	90	$\text{m}\Omega$
R _{DS(ON) LS FET}	On-resistance, low-side FET	Between SW_Bx and $PGND_Bx$ pins ($I = 1\text{ A}$)		33	50	$\text{m}\Omega$
	Overshoot during start-up	Slew-rate = $10\text{ mV}/\mu\text{s}$		< 50		mV
I _{PFM-PWM}	PFM-to-PWM switch - current threshold ⁽⁴⁾			600		mA
I _{PWM-PFM}	PWM-to-PFM switch - current threshold ⁽⁴⁾			240		mA
	Output pulldown resistance	Regulator disabled	150	250	350	Ω
	Powergood threshold for interrupt BUCKx_INT(BUCKx_SC_INT), difference from final voltage	Rising ramp voltage, enable or voltage change	-23	-17	-10	mV
		Falling ramp, voltage change	10	17	23	
	Powergood threshold for status signal BUCKx_STAT(BUCKx_PG_STAT)	During operation, status signal is forced to 0 during voltage change.	-23	-17	-10	mV
PROTECTION FEATURES						
Thermal warning		Temperature rising, CONFIG(TDIE_WARN_LEVEL) = 0		125		$^{\circ}\text{C}$
		Temperature rising, CONFIG(TDIE_WARN_LEVEL) = 1		105		
		Hysteresis		15		
Thermal shutdown		Temperature rising		150		$^{\circ}\text{C}$
		Hysteresis		15		
VANA _{UVLO}	VANA undervoltage lockout	Voltage falling	2.3	2.4	2.5	V
		Hysteresis		50		mV
LOAD CURRENT MEASUREMENT						
Current measurement range		Maximum code		20.46		A
Resolution		LSB		20		mA
Measurement accuracy		$I_{OUT} \geq 1\text{ A}$		< 10%		

6.5 Electrical Characteristics (continued)

Limits apply over the junction temperature range $-40^{\circ}\text{C} \leq T_J \leq +125^{\circ}\text{C}$, specified $V_{(VANA)}$, V_{IN} , $V_{(NRST)}$, V_{OUT} and I_{OUT} range, unless otherwise noted. Typical values are at $T_J = 25^{\circ}\text{C}$, $f_{SW} = 3\text{ MHz}$, $V_{(VANA)} = V_{IN} = 3.7\text{ V}$ and $V_{OUT} = 1\text{ V}$, unless otherwise noted.^{(1) (2)}

PARAMETER		TEST CONDITIONS	MIN	TYP	MAX	UNIT
CURRENT CONSUMPTION						
Shutdown current consumption		$V_{(NRST)} = 0\text{ V}$		1		μA
Standby current consumption, converter cores disabled		$V_{(NRST)} = 1.8\text{ V}$		6		μA
Active current consumption during PFM operation, one converter core enabled		$V_{(NRST)} = 1.8\text{ V}$, $I_{OUT} = 0\text{ mA}$, not switching		55		μA
Active current consumption during PWM operation, per converter core		$V_{(NRST)} = 1.8\text{ V}$, $I_{OUT} = 0\text{ mA}$, $L = 0.47\text{ }\mu\text{H}$		14.5		mA
DIGITAL INPUT SIGNALS NRST, ENx, SCL, SDA						
V_{IL}	Input low level				0.4	V
V_{IH}	Input high level		1.2			V
V_{HYS}	Hysteresis of Schmitt trigger inputs (SCL, SDA)		10	80	160	mV
	ENx pull-down resistance	$\text{ENx_PD} = 1$	350	500	720	$\text{k}\Omega$
	NRST pull-down resistance	Always present	800	1200	1700	$\text{k}\Omega$
DIGITAL OUTPUT SIGNALS nINT, SDA						
V_{OL}	Output low level	$I_{SOURCE} = 2\text{ mA}$,			0.4	V
R_P	External pullup resistor for nINT	To VIO supply		10		$\text{k}\Omega$
ALL DIGITAL INPUTS						
I_{LEAK}	Input current	All logic inputs over pin voltage range	-1		1	μA

- (1) All voltage values are with respect to network ground.
- (2) Minimum (MIN) and maximum (MAX) limits are specified by design, test, or statistical analysis. Typical (TYP) numbers are not verified, but do represent the most likely norm.
- (3) The maximum output current can be limited by the forward current limit, $I_{LIM\ FWD}$. The maximum output current is available with 5-A forward current limit setting.
- (4) The final PFM-to-PWM and PWM-to-PFM switchover current varies slightly and is dependant on the output voltage, input voltage and the magnitude of inductor's ripple current.

6.6 I²C Serial Bus Timing Requirements

See table notes.^{(1) (2)}

		MIN	MAX	UNIT	
f_{SCL}	Serial clock frequency	Standard mode		100	kHz
		Fast mode		400	kHz
		Fast mode +		1	MHz
		High-speed mode, $C_b = 100\text{ pF}$		3.4	MHz
		High-speed mode, $C_b = 400\text{ pF}$		1.7	MHz
t_{LOW}	SCL low time	Standard mode	4.7		μs
		Fast mode	1.3		
		Fast mode +	0.5		
		High-speed mode, $C_b = 100\text{ pF}$	160		ns
		High-speed mode, $C_b = 400\text{ pF}$	320		

6.6 I²C Serial Bus Timing Requirements (continued)

See table notes. ⁽¹⁾ ⁽²⁾

		MIN	MAX	UNIT	
t _{HIGH}	SCL high time	Standard mode	4	μs	
		Fast mode	0.6		
		Fast mode +	0.26		
		High-speed mode, C _b = 100 pF	60	ns	
		High-speed mode, C _b = 400 pF	120		
t _{SU;DAT}	Data setup time	Standard mode	250	ns	
		Fast mode	100		
		Fast mode +	50		
		High-speed mode	10		
t _{HD;DAT}	Data hold time	Standard mode	0	3.45	μs
		Fast mode	0	0.9	
		Fast mode +	0		ns
		High-speed mode, C _b = 100 pF	0	70	
		High-speed mode, C _b = 400 pF	0	150	
t _{SU;STA}	Setup time for a start or a repeated start condition	Standard mode	4.7	μs	
		Fast mode	0.6		
		Fast mode +	0.26	ns	
		High-speed mode	160		
t _{HD;STA}	Hold time for a start or a repeated start condition	Standard mode	4	μs	
		Fast mode	0.6		
		Fast mode +	0.26	ns	
		High-speed mode	160		
t _{BUF}	Bus free time between a stop and start condition	Standard mode	4.7	μs	
		Fast mode	1.3		
		Fast mode +	0.5		
t _{SU;STO}	Setup time for a stop condition	Standard mode	4	μs	
		Fast mode	0.6		
		Fast mode +	0.26	ns	
		High-speed mode	160		
t _{rDA}	Rise time of SDA signal	Standard mode		1000	ns
		Fast mode		300	
		Fast mode +		120	
		High-speed mode, C _b = 100 pF		80	
		High-speed mode, C _b = 400 pF		160	
t _{rDA}	Fall time of SDA signal	Standard mode		250	ns
		Fast mode		250	
		Fast mode +		120	
		High-speed mode, C _b = 100 pF		80	
		High-speed mode, C _b = 400 pF		160	
t _{rCL}	Rise time of SCL signal	Standard mode		1000	ns
		Fast mode		300	
		Fast mode +		120	
		High-speed Mode, C _b = 100 pF		40	
		High-speed Mode, C _b = 400 pF		80	

6.6 I²C Serial Bus Timing Requirements (continued)

See table notes. ⁽¹⁾ ⁽²⁾

		MIN	MAX	UNIT
t _{rCL1}	Rise time of SCL signal after a repeated start condition and after an acknowledge bit	Standard mode	1000	ns
		Fast mode	300	
		Fast mode +	120	
		High-speed mode, C _b = 100 pF	80	
		High-speed mode, C _b = 400 pF	160	
t _{fCL}	Fall time of a SCL signal	Standard mode	300	ns
		Fast mode	300	
		Fast mode +	120	
		High-speed mode, C _b = 100 pF	40	
		High-speed mode, C _b = 400 pF	80	
C _b	Capacitive load for each bus line (SCL and SDA)		400	pF
t _{SP}	Pulse width of spike suppressed in SCL and SDA lines (spikes that are less than the indicated width are suppressed)	Fast mode, fast mode +	50	ns
		High-speed mode	10	

(1) See [Figure 6-1](#) for timing diagram.

(2) C_b refers to the capacitance of one bus line. C_b is expressed in pF units.

6.7 Switching Characteristics

Limits apply over the junction temperature range $-40^{\circ}\text{C} \leq T_J \leq +125^{\circ}\text{C}$, specified V_(VANA), V_{IN}, V_(NRST), V_{OUT} and I_{OUT} range, unless otherwise noted. Typical values are at T_J = 25°C, f_{SW} = 3 MHz, V_(VANA) = V_{IN} = 3.7 V and V_{OUT} = 1 V, unless otherwise noted. ⁽¹⁾

PARAMETER	TEST CONDITIONS	MIN	TYP	MAX	UNIT
f _{sw}	V _{OUT} ≥ 0.6 V	2.7	3	3.3	MHz
	V _{OUT} < 0.6 V	1.8	2	2.2	
Start-up time (soft start)	From ENx to V _{OUT} = 0.225 V (slew-rate control begins), C _{OUT-TOTAL} = 44 μF, no load		140		μs
Output voltage slew-rate ⁽²⁾	SLEW_RATEx[2:0] = 000, V _{OUT} ≥ 0.5 V	-15%	30	15%	mV/μs
	SLEW_RATEx[2:0] = 001, V _{OUT} ≥ 0.5 V	-15%	15	15%	
	SLEW_RATEx[2:0] = 010, V _{OUT} ≥ 0.5 V	-15%	10	15%	
	SLEW_RATEx[2:0] = 011, V _{OUT} ≥ 0.5 V	-15%	7.5	15%	
	SLEW_RATEx[2:0] = 100, V _{OUT} ≥ 0.5 V	-15%	3.8	15%	
	SLEW_RATEx[2:0] = 101, V _{OUT} ≥ 0.5 V	-15%	1.9	15%	
	SLEW_RATEx[2:0] = 110, V _{OUT} ≥ 0.5 V	-15%	0.94	15%	
Load current measurement time	PFM mode (automatically changing to PWM mode for the measurement)		50		μs
	PWM mode		4		

(1) Minimum (MIN) and maximum (MAX) limits are specified by design, test, or statistical analysis. Typical (TYP) numbers are not verified, but do represent the most likely normal.

(2) Specified by design without testing. The slew-rate can be limited by the current limit (forward or negative current limit), output capacitance, and load current.

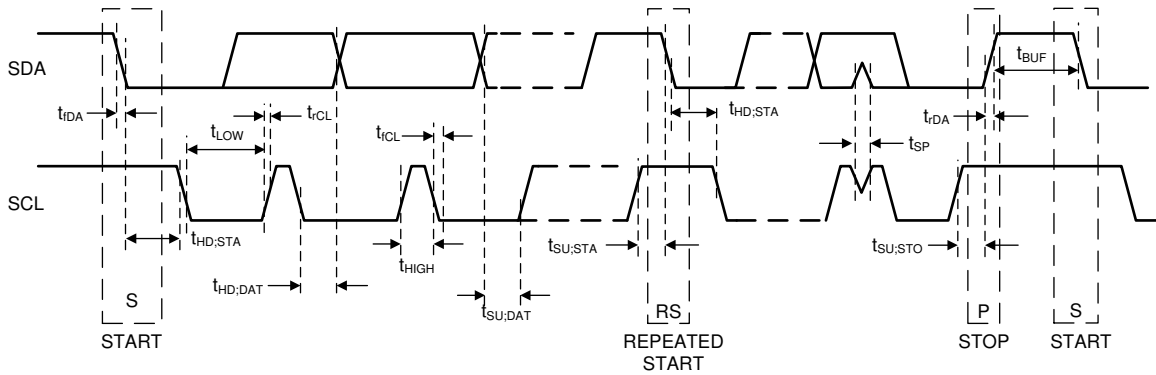

Figure 6-1. I²C Timing

6.8 Typical Characteristics

Unless otherwise specified: $T_A = 25^\circ\text{C}$, $V_{IN} = 3.7\text{ V}$, $f_{SW} = 3\text{ MHz}$, $L = 470\text{ nH}$.

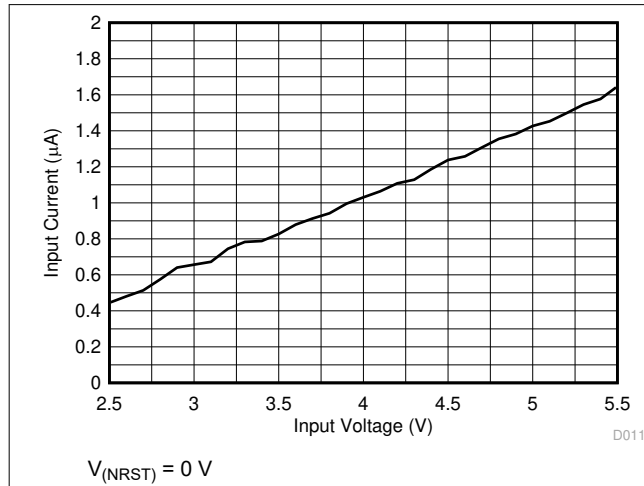

Figure 6-2. Shutdown Current Consumption vs Input Voltage

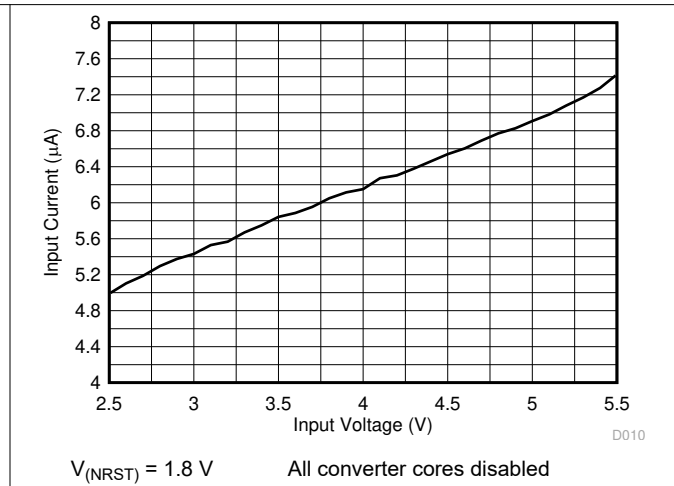

Figure 6-3. Standby Current Consumption vs Input Voltage

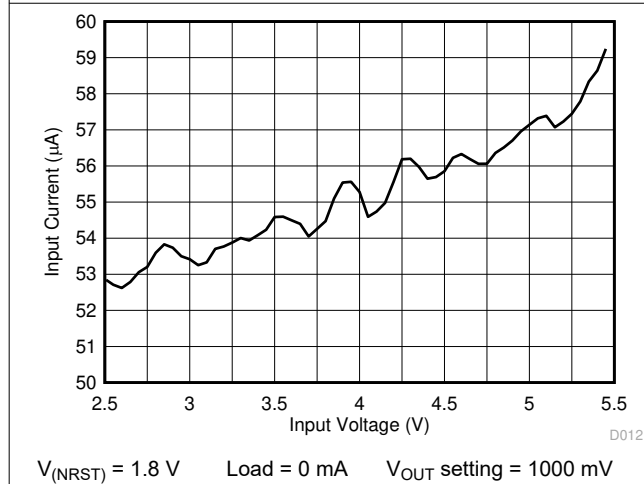

Figure 6-4. PFM Mode Current Consumption vs Input Voltage — One Output Enabled

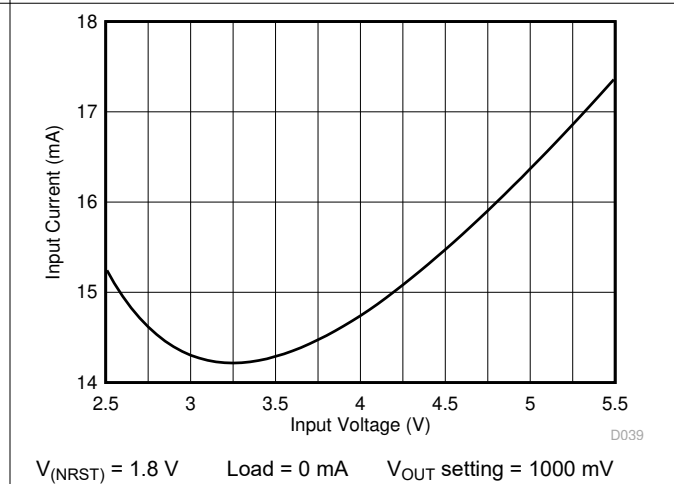

Figure 6-5. PWM Mode Current Consumption vs Input Voltage — One Output Enabled

7 Detailed Description

7.1 Overview

The LP8758-xx devices are a family of configurable step-down DC-DC converters with four converter cores. The LP8758-xx devices are ideally suited for systems powered from 2.5-V to 5.5-V supply voltage. In LP8758-EA the cores are configured for a four single-phase configuration. The LP8758-EA is well suited for space-constrained applications where high efficiency is required at low output voltages. Typical applications include network interface cards, modem cards, smart phones and mobile devices, solid-state drives (SSDs), systems-on-a-chip (SoCs), ASICs, and low power processors.

There are two modes of operation for the converter cores, depending on the output current required: pulse-width modulation (PWM) and pulse-frequency modulation (PFM). The cores operate in PWM mode at high load currents of approximately 600 mA or higher. Lighter output current loads cause the converter cores to automatically switch into PFM mode for reduced current consumption and a longer battery life when forced PWM mode is disabled. Additional features include soft-start, undervoltage lockout, overload protection, thermal warning, and thermal shutdown.

7.1.1 Buck Information

The LP8758-EA has four integrated high-efficiency buck converter cores. The cores are designed for flexibility; most of the functions are programmable, thus giving a possibility to optimize the regulator operation for each application.

7.1.1.1 Operating Modes

- OFF: Output is isolated from the input voltage rail in this mode. Output has an optional pulldown resistor.
- PWM: Converter operates in buck configuration with fixed switching frequency.
- PFM: Converter switches only when output voltage decreases below programmed threshold. Inductor current is discontinuous.

7.1.1.2 Programmability

The following parameters can be programmed through registers:

- Output voltage
- Forced PWM operation
- Switch current limit
- Output voltage slew rate
- Enable and disable delays

7.1.1.3 Features

- Dynamic voltage scaling (DVS) support with programmable slew-rate
- Automatic mode control based on the loading
- Synchronous rectification
- Current mode loop with PI compensator
- Optional spread spectrum technique to reduce EMI
- Soft start
- Power-good flag with maskable interrupt
- Phase control for optimized EMI: The four cores operate 90° out of phase thereby reducing input ripple current
- Average output current sensing (for PFM entry and load current measurement)
- Voltage sensing from point of the load

7.2 Functional Block Diagram

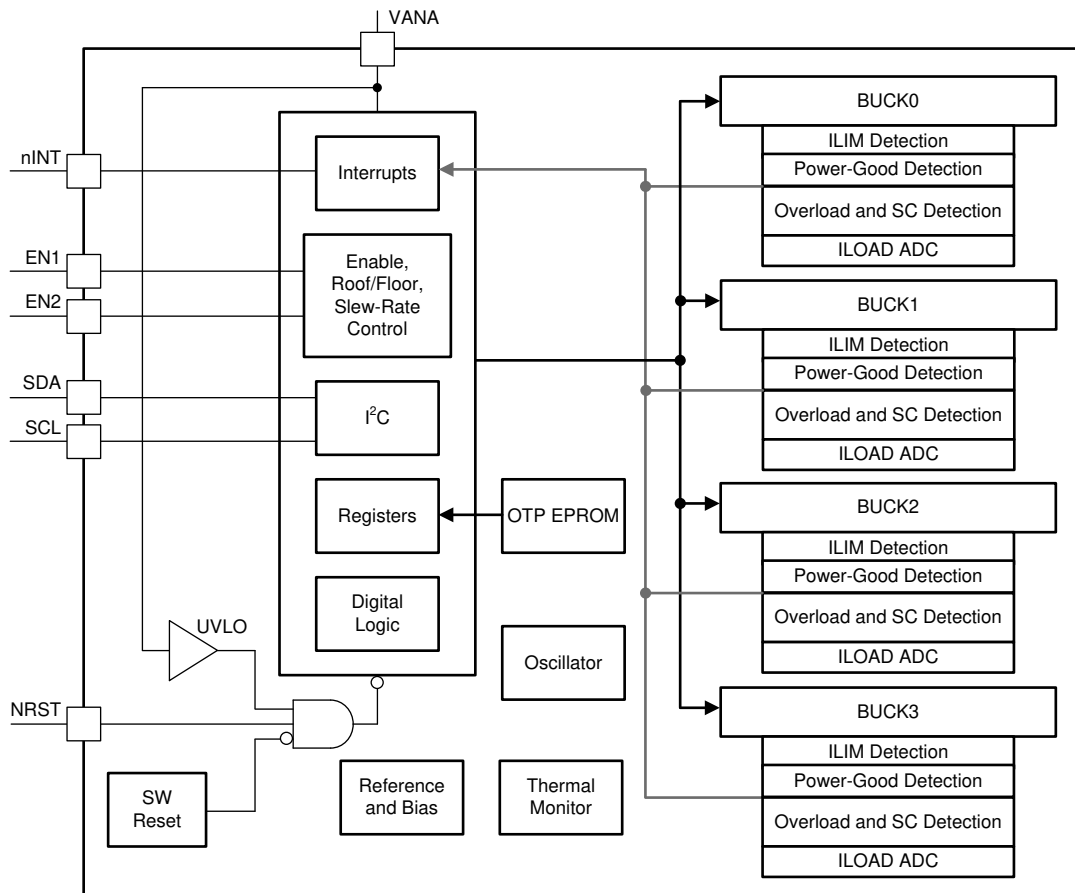

7.3 Feature Description

7.3.1 Overview

A block diagram of a single core is shown in [Figure 7-1](#).

Interleaving switching action of the converters is illustrated in [Figure 7-2](#). The LP8758-EA regulator switches each core 90° apart, reducing input ripple current.

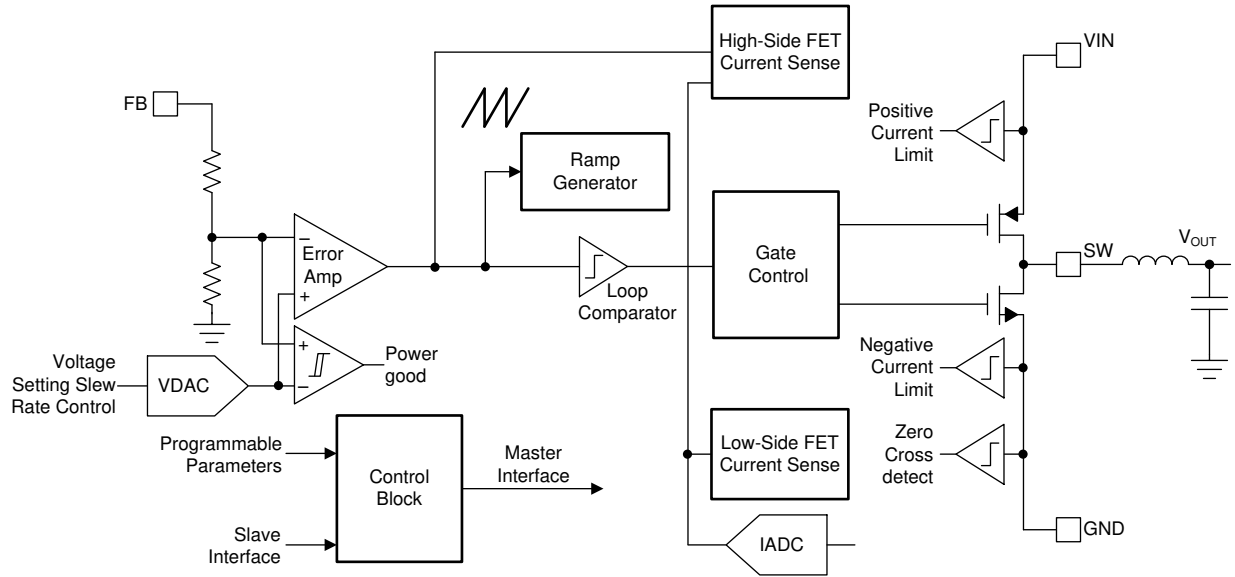

Figure 7-1. Detailed Block Diagram Showing One Core

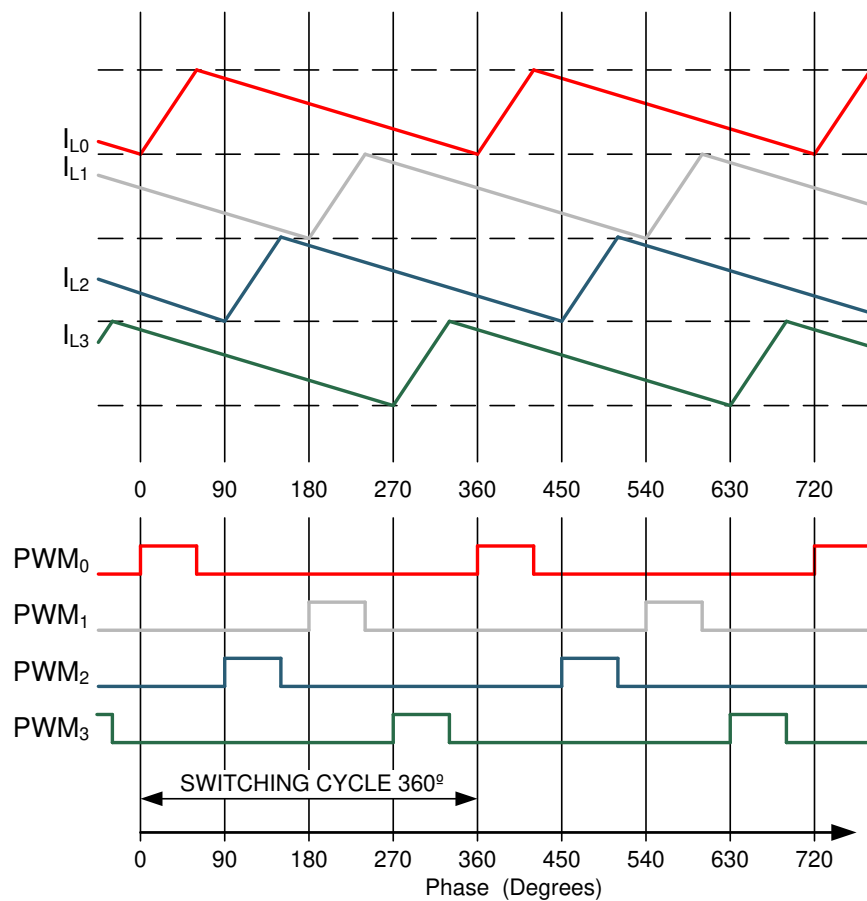

Figure 7-2. PWM Timings and Inductor Current Waveforms ¹

¹ Graph is not in scale and is for illustrative purposes only.

7.3.1.1 Transition Between PWM and PFM Modes

The LP8758-EA converter cores operate in PWM mode at load current of about 600 mA or higher. At lighter load current levels the cores automatically switches into PFM mode for reduced current consumption when Forced PWM mode is disabled (AUTO mode operation). By combining the PFM and the PWM modes a high efficiency is achieved over a wide output-load current range.

7.3.1.2 Buck Converter Load Current Measurement

Buck load current can be monitored via I²C registers. The monitored buck converter core is selected with the SEL_I_LOAD.LOAD_CURRENT_BUCK_SELECT[1:0] register bits. A write to this selection register starts a current measurement sequence. The measurement sequence is typically 50 μs long. The LP8758-EA device can be configured to give out an interrupt INT_TOP.I_LOAD_READY after the load current measurement sequence is finished. Load current measurement interrupt can be masked with TOP_MASK.I_LOAD_READY_MASK bit. The measurement result can be read from registers I_LOAD_1 and I_LOAD_2. Register I_LOAD_1 bits BUCK_LOAD_CURRENT[7:0] give out the LSB bits and register I_LOAD_2 bits BUCK_LOAD_CURRENT[9:8] the MSB bits. The measurement result BUCK_LOAD_CURRENT[9:0] LSB is 20 mA, and maximum value of the measurement is 20.46 A.

7.3.1.3 Spread-Spectrum Mode

Systems with periodic switching signals may generate a large amount of switching noise in a set of narrowband frequencies (the switching frequency and its harmonics). The usual solution to reduce noise coupling is to add EMI-filters and shields to the boards. The register-selectable spread-spectrum mode of the device minimizes the need for output filters, ferrite beads, or chokes. In spread-spectrum mode, the switching frequency varies randomly by ±5% about the center frequency, reducing the EMI emissions radiated by the converter and associated passive components and PCB traces (see [Figure 7-3](#)). This feature is enabled with the CONFIG.EN_SPREAD_SPEC bit, and it affects all the buck converter cores.

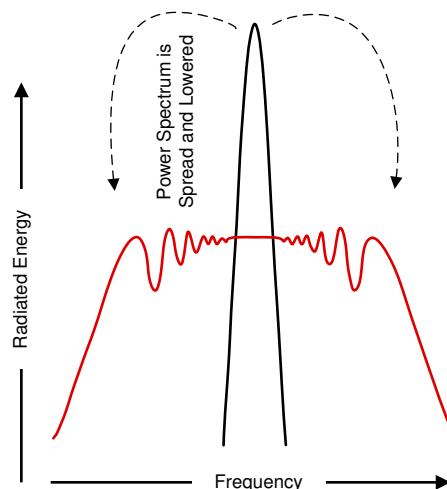

Where a fixed frequency converter exhibits large amounts of spectral energy at the switching frequency, the spread spectrum architecture of the v spreads that energy over a large bandwidth.

Figure 7-3. Spread-Spectrum Modulation

7.3.2 Power-Up

The power-up sequence for the LP8758-EA is as follows:

- VANA (and VIN_Bx) reach minimum recommended levels ($V_{(VANA)} > VANA_{UVLO}$).
- NRST is set to high level. This initiates power-on-reset (POR), OTP reading and enables the system I/O interface. The I²C host must allow at least 1.2 ms before writing or reading data to the LP8758-EA.
- The device enters STANDBY mode.
- The host can change the default register setting by I²C if needed.

- One or more of the converter cores can be enabled or disabled by one or more of the ENx pins and by the I²C interface.

7.3.3 Regulator Control

7.3.3.1 Enabling and Disabling

The buck converter cores can be enabled when the device is in STANDBY or ACTIVE state. There are two ways to enable and disable the buck converter cores:

- Using BUCKx_CTRL1.EN_BUCKx register bit (when BUCKx_CTRL1.EN_PIN_CTRLx register bit is 0).
- Using EN1/2 control pins (BUCKx_CTRL1.EN_BUCKx register bit is 1 *and* BUCKx_CTRL1.EN_PIN_CTRLx register bit is 1).

If the EN1/2 control pins are used for enable and disable, the delay from the control signal rising edge to start-up is set by BUCKx_DELAY.BUCKx_STARTUP_DELAY[3:0] bits and the delay from control signal falling edge to shutdown is set by BUCKx_DELAY.BUCKx_SHUTDOWN_DELAY[3:0] bits. The delays are valid only for EN1/2 signal and not for control with BUCKx_CTRL1.EN_BUCKx bit. The delay time implemented by EN1/2 has overall ±10% timing accuracy.

The control of the converter cores (with 0 ms delays) is shown in [Table 7-1](#).

Table 7-1. Regulator Control

CONTROL METHOD	ROW	EN_BUCKx	BUCKx_CTRL1 EN_PIN_CTRLx	BUCKx_CTRL1 EN_PIN_SELECTx	BUCKx_CTRL1 EN_ROOF_FLOORx	EN1 PIN	EN2 PIN	BUCKx OUTPUT VOLTAGE
Enable or disable control with EN_BUCKx bit	1	0	Don't Care	Don't Care	Don't Care	Don't Care	Don't Care	Disabled
	2	1	0	Don't Care	Don't Care	Don't Care	Don't Care	BUCKx_VOUT.BUCKx_VSET[7:0]
Enable or disable control with EN1 pin	3	1	1	0	0	Low	Don't Care	Disabled
	4	1	1	0	0	High	Don't Care	BUCKx_VOUT.BUCKx_VSET[7:0]
Enable or disable control with EN2 pin	5	1	1	1	0	Don't Care	Low	Disabled
	6	1	1	1	0	Don't Care	High	BUCKx_VOUT.BUCKx_VSET[7:0]
Roof or floor control with EN1 pin	7	1	1	0	1	Low	Don't Care	BUCKx_FLOOR_VOUT.BUCKx_FLOOR_VSET[7:0]
	8	1	1	0	1	High	Don't Care	BUCKx_VOUT.BUCKx_VSET[7:0]
Roof or floor control with EN2 pin	9	1	1	1	1	Don't Care	Low	BUCKx_FLOOR_VOUT.BUCKx_FLOOR_VSET[7:0]
	10	1	1	1	1	Don't Care	High	BUCKx_VOUT.BUCKx_VSET[7:0]

The following buck configuration bit settings allows the device to enable or disable the corresponding buck using the ENx pin:

- BUCKx_CTRL1.EN_BUCKx = 1
- BUCKx_CTRL1.EN_PIN_CTRLx = 1
- BUCKx_CTRL1.EN_ROOF_FLOORx = 0
- BUCKx_VOUT.BUCKx_VSET[7:0] = Required voltage when the ENx pin is high
- The enable pin for control is selected with BUCKx_CTRL1.EN_PIN_SELECTx

When the ENx pin is low, [Table 7-1](#) row 3 (or 5) is valid, and the converter core is disabled. By setting ENx pin high, [Table 7-1](#) row 4 (or 6) is valid, and the converter core is enabled with required voltage.

If a converter core is enabled all the time, and the ENx pin controls selection between the two voltage levels, then the following configuration is used:

- BUCKx_CTRL1.EN_BUCKx = 1
- BUCKx_CTRL1.EN_PIN_CTRLx = 1
- BUCKx_CTRL1.EN_ROOF_FLOORx = 1
- BUCKx_VOUT.BUCKx_VSET[7:0] = Required voltage when the ENx pin is high
- The enable pin for control is selected with BUCKx_CTRL1.EN_PIN_SELECTx

When the ENx pin is low, [Table 7-1](#) row 7 (or 9) is valid, and the core is enabled with a voltage defined by BUCKx_FLOOR_VOUT.BUCKx_FLOOR_VSET[7:0] bits. Setting the ENx pin high, [Table 7-1](#) row 8 (or 10) is valid, and the core is enabled with a voltage defined by BUCKx_VOUT.BUCKx_VSET[7:0] bits.

If the core is controlled by I²C writings, the BUCKx_CTRL1.EN_PIN_CTRLx bit is set to 0. The enable or disable is controlled by the BUCKx_CTRL1.EN_BUCKx bit, and when the regulator is enabled, the output voltage is defined by the BUCKx_VOUT.BUCKx_VSET[7:0] bits. The Table 7-1 rows 1 and 2 are valid for I²C controlled operation (ENx pins are ignored).

The buck converter core is enabled by the ENx pin or by I²C writing as shown in Figure 7-4. The soft-start circuit limits the in-rush current during start-up. Output voltage increase rate is around 5 mV/μsec during soft-start. When the output voltage rises to approximately 0.3 V, the output voltage becomes slew-rate controlled. If there is a short circuit at the output, and the output voltage does not increase above a 0.35-V level in 1 ms, the converter core is disabled, and interrupt is set. When the output voltage reaches the powergood threshold level the INT_BUCK_x.BUCKx_PG_INT interrupt flag is set. The powergood interrupt flag can be masked using BUCK_x_MASK.BUCKx_PG_MASK bit.

The ENx input pins have integrated pull-down resistors. The pull-down resistors are enabled by default and host can disable those with CONFIG.ENx_PD bits.

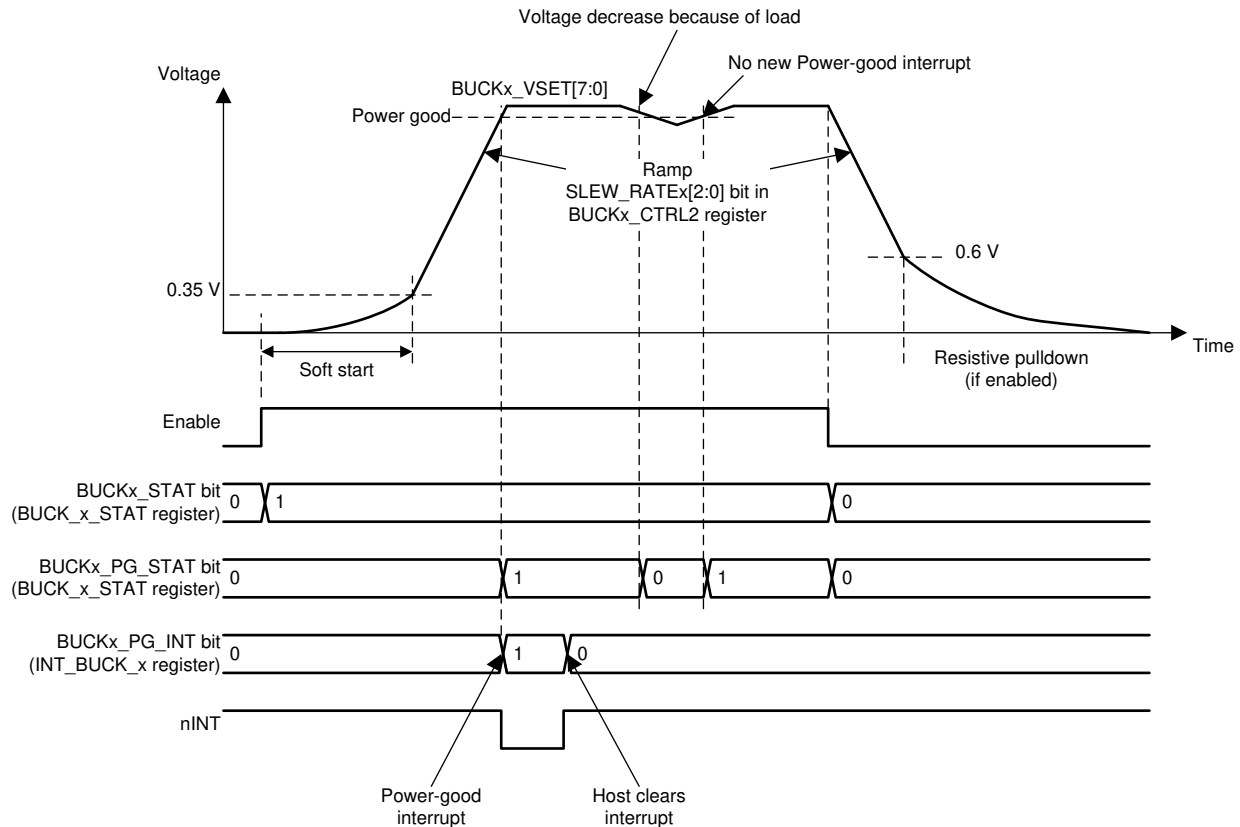

Figure 7-4. Converter Core Enable and Disable

7.3.3.2 Changing Output Voltage

The converter core's output voltage can be changed by the ENx pin (voltage levels defined by the BUCKx_VOUT and BUCKx_FLOOR_VOUT registers) or by writing to the BUCKx_VOUT and BUCKx_FLOOR_VOUT registers. The voltage change is always slew-rate controlled, and the slew-rate is defined by the BUCKx_CTRL2.SLEW_RATEx[2:0] bits. During voltage change the Forced PWM mode is used automatically. When the programmed output voltage is achieved, the mode becomes the one defined by load current, and the BUCKx_CTRL1.BUCKx_FPWM bit.

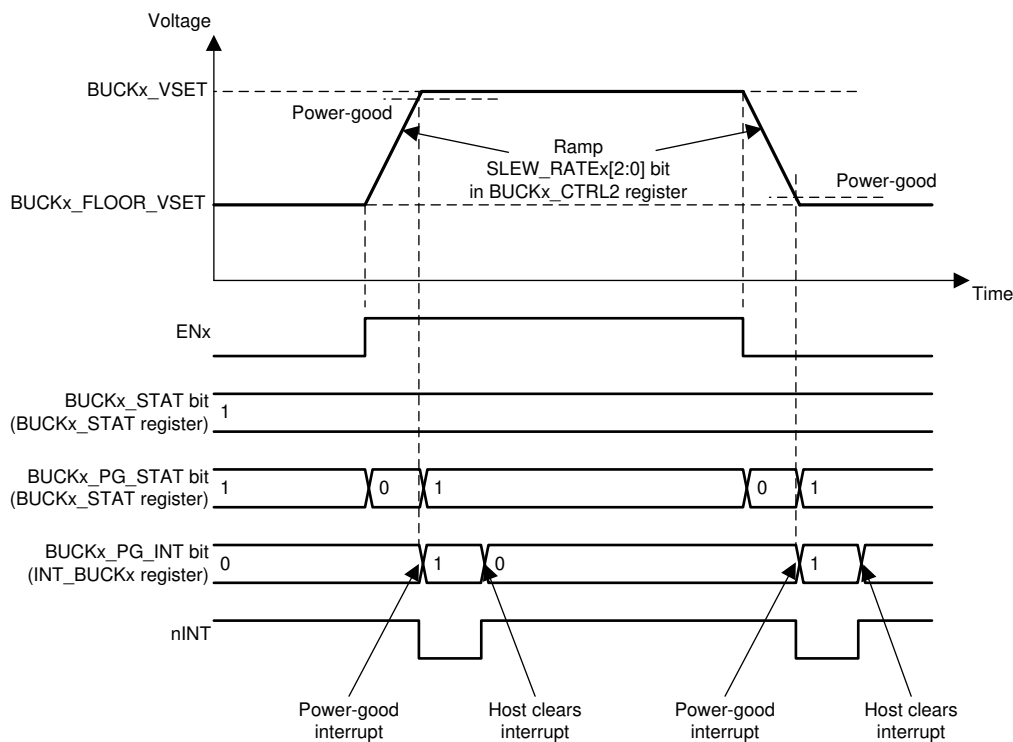

Figure 7-5. Output Voltage Change

7.3.4 Device Reset Scenarios

There are three reset methods implemented on the LP8758-EA:

- Software reset with RESET.SW_RESET register bit;
- Reset from low logic level of NRST signal; and
- Undervoltage lockout (UVLO) reset from VANA supply.

A SW-reset occurs when RESET.SW_RESET bit is written 1. The bit is automatically cleared after writing. This event disables all the buck converter cores immediately, resets all the register bits to the default values and OTP bits are loaded (see [Figure 7-7](#)). I²C interface is not reset during software reset.

If VANA supply voltage falls below UVLO threshold level or NRST signal is set low, then all the converter cores are disabled immediately, and all the register bits are reset to the default values. When the VANA supply voltage is above UVLO threshold level and NRST signal rises above threshold level an internal power-on reset (POR) occurs. OTP bits are loaded to the registers, and a start-up is initiated according to the register settings.

7.3.5 Diagnosis and Protection Features

The LP8758-EA is capable of providing three levels of protection features:

- Warnings for diagnosis which sets interrupt;
- Protection events which are disabling one or more converter cores; and
- Faults which are causing the device to shutdown.

When the device detects one or more warning or protection conditions, the LP8758-EA sets the flag bits indicating what protection or warning conditions have occurred, and the nINT pin is pulled low. nINT is released again after a clear of flags is complete. The nINT signal stays low until all the pending interrupts are cleared.

When a fault is detected, it is indicated by a INT_TOP.RESET_REG interrupt flag after next start-up.

Table 7-2. Summary of Interrupt Signals

EVENT	RESULT	INTERRUPT REGISTER AND BIT	INTERRUPT MASK	STATUS BIT	RECOVERY / INTERRUPT CLEAR
Current limit triggered (20 μ s debounce)	No effect	INT_TOP.INT_BUCKx = 1 INT_BUCKx.BUCKx_ILIM_INT = 1	BUCKx_MASK.BUCKx_ILIM_MASK	BUCKx_STAT.BUCKx_ILIM_STAT	Write 1 to INT_BUCKx.BUCKx_ILIM_INT bit Interrupt is not cleared if current limit is active
Short circuit ($V_{OUT} < 0.35$ V at 1 ms after enable) or overload (V_{OUT} decreasing below 0.35 V during operation, 1 ms debounce)	Converter core disable	INT_TOP.INT_BUCKx = 1 INT_BUCK_0_1.BUCKx_SC_INT = 1 or INT_BUCK_2_3.BUCKx_SC_INT = 1	N/A	N/A	Write 1 to INT_BUCK_0_1.BUCKx_SC_INT or to INT_BUCK_2_3.BUCKx_SC_INT bit
Thermal Warning	No effect	INT_TOP.TDIE_WARN = 1	TOP_MASK.TDIE_WARN_MASK	TOP_STAT.TDIE_WARN_STAT	Write 1 to INT_TOP.TDIE_WARN bit Interrupt is not cleared if temperature is above thermal warning level
Thermal Shutdown	All converter cores disabled	INT_TOP.TDIE_SD = 1	N/A	TOP_STAT.TDIE_SD_STAT	Write 1 to INT_TOP.TDIE_SD bit Interrupt is not cleared if temperature is above thermal shutdown level
Powergood, output voltage reaches the programmed value	No effect	INT_TOP.INT_BUCKx = 1 INT_BUCK_0_1.BUCKx_PG_INT = 1 or INT_BUCK_2_3.BUCKx_PG_INT = 1	BUCK_0_1_MASK.BUCKx_PG_MASK BUCK_2_3_MASK.BUCKx_PG_MASK	BUCK_0_1_STAT.BUCKx_PG_STAT BUCK_2_3_STAT.BUCKx_PG_STAT	Write 1 to INT_BUCK_0_1.BUCKx_PG_INT bit or to INT_BUCK_2_3.BUCKx_PG_INT bit
Load current measurement ready	No effect	INT_TOP.I_LOAD_READY = 1	TOP_MASK.I_LOAD_READY_MASK	N/A	Write 1 to INT_TOP.I_LOAD_READY bit
Start-up (NRST rising edge)	Device ready for operation, registers reset to default values	INT_TOP.RESET_REG = 1	TOP_MASK.RESET_REG_MASK	N/A	Write 1 to INT_TOP.RESET_REG bit
Glitch on supply voltage and UVLO triggered (VANA falling and rising)	Immediate shutdown followed by powerup, registers reset to default values	INT_TOP.RESET_REG = 1	TOP_MASK.RESET_REG_MASK	N/A	Write 1 to INT_TOP.RESET_REG bit
Software requested reset	Immediate shutdown followed by powerup, registers reset to default values	INT_TOP.RESET_REG = 1	TOP_MASK.RESET_REG_MASK	N/A	Write 1 to INT_TOP.RESET_REG bit

7.3.5.1 Warnings for Diagnosis (Interrupt)

7.3.5.1.1 Output Current Limit

The converter cores have programmable output peak current limits. The limits are individually programmed for all buck converter cores with BUCKx_CTRL2.ILIMx[2:0] bits. If the load current is increased so that the current limit is triggered, the regulator continues to regulate to the limit current level (current peak regulation). The voltage may decrease if the load current is higher than limit current. If the current regulation continues for 20 μ s, the LP8758-EA device sets the INT_BUCKx.BUCKx_ILIM_INT bit and pulls the nINT pin low. The host processor can read BUCKx_STAT.BUCKx_ILIM_STAT bits to see if the converter cores is still in peak current regulation mode.

For example, if the load on Buck0 output is so high that the output voltage V_{OUT} decreases below a 350-mV level, the LP8758-EA device disables the converter core Buck0 and sets the INT_BUCK_0_1.BUCK0_SC_INT bit. In addition the BUCK_0_1_STAT.BUCK0_STAT bit is set to 0. The interrupt is cleared when the host processor writes 1 to INT_BUCK_0_1.BUCK0_SC_INT bit. The overload situation is shown in [Figure 7-6](#).

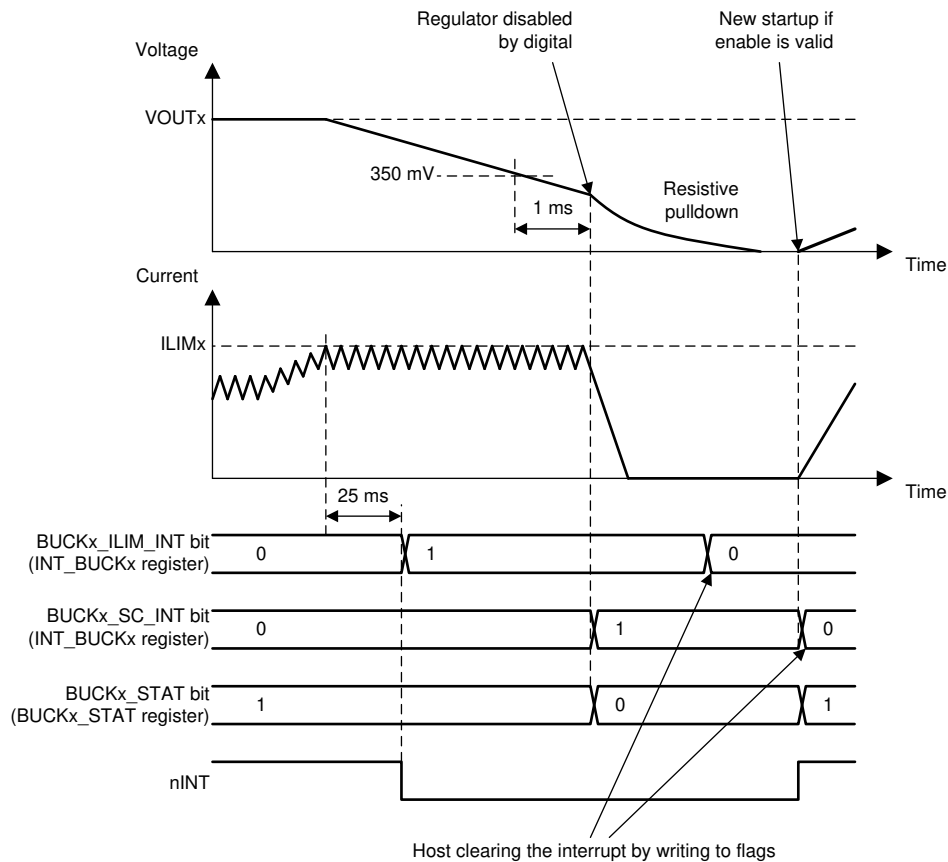

Figure 7-6. Overload Situation

7.3.5.1.2 Thermal Warning

The LP8758-EA device includes protection features against overtemperature by setting an interrupt for host processor. The threshold level of the thermal warning is selected with CONFIG.TDIE_WARN_LEVEL bit.

If the LP8758-EA device temperature increases above the thermal warning level, the device sets INT_TOP.TDIE_WARN bit and pulls nINT pin low. The status of the thermal warning can be read from TOP_STAT.TDIE_WARN_STAT bit, and the interrupt is cleared by writing 1 to INT_TOP.TDIE_WARN bit.

7.3.5.2 Protection (Regulator Disable)

If the regulator is disabled because of protection or fault (short-circuit protection, overload protection, thermal shutdown, or undervoltage lockout), the output power FETs are set to high-impedance mode, and the output pulldown resistor is enabled (if enabled with the BUCKx_CTRL1.EN_RDISx bits). The turnoff time of the output voltage is defined by the output capacitance, load current, and the resistance of the integrated pulldown resistor.

7.3.5.2.1 Short-Circuit and Overload Protection

A short-circuit protection feature allows the LP8758-EA to protect itself and external components against short circuit at the output or against overload during start-up. The fault threshold is 350 mV, and the protection is triggered and the converter core is disabled if the output voltage is still below the threshold level 1 ms after the converter core was enabled.

In a similar way the overload situation is protected during normal operation. If a feedback-pin voltage falls below 0.35 V, and remains below the threshold level for 1 ms, the respective converter core is disabled.

For example, if the Buck core 0 output is overloaded, then the INT_BUCK_0_1.BUCK0_SC_INT and the INT_TOP.INT_BUCK0 bits are set to 1, the BUCK_0_1_STAT.BUCK0_STAT bit is set to 0, and the nINT signal is pulled low. The host processor clears the interrupt by writing 1 to the INT_BUCK_0_1.BUCK0_SC_INT bit.

The regulator makes a new start-up attempt (upon clearing the interrupt) if the enable register bits, ENx control signal, or both are valid.

7.3.5.2.2 Thermal Shutdown

The LP8758-EA has an over-temperature protection function that operates to protect itself from short-term misuse and overload conditions. When the junction temperature exceeds around 150°C, the cores are disabled, the INT_TOP.TDIE_SD bit is set to 1, the nINT signal is pulled low, and the device enters STANDBY. The nINT is cleared by writing 1 to the INT_TOP.TDIE_SD bit. If the temperature is above the thermal shutdown level, then the interrupt is not cleared. The host can read the status of the thermal shutdown from the TOP_STAT.TDIE_SD_STAT bit. Converter cores cannot be enabled as long as the junction temperature is above the thermal shutdown level or the thermal shutdown interrupt is pending.

7.3.5.3 Fault (Power Down)

7.3.5.3.1 Undervoltage Lockout

When the input voltage falls below $VANA_{UVLO}$ at the VANA pin, the converter cores are disabled immediately, and the output capacitors are discharged using the pulldown resistors and the LP8758-EA device enters SHUTDOWN. When VANA voltage is above the UVLO threshold level and NRST signal is high, the device powers up to STANDBY state.

If the reset interrupt is unmasked by default ($TOP_MASK.RESET_REG_MASK = 0$) the INT_TOP.RESET_REG interrupt indicates that the device has been in SHUTDOWN. The host processor must clear the interrupt by writing 1 to the INT_TOP.RESET_REG bit. If the host processor reads the INT_TOP.RESET_REG flag after detecting an nINT low signal, it knows that the input supply voltage has been below UVLO level (or the host has requested reset), and the registers are reset to default values.

7.3.6 Digital Signal Filtering

The digital signals have debounce filtering. The signal or supply is sampled with a clock signal and a counter. This results as an accuracy of one clock period for the debounce window.

Table 7-3. Digital Signal Filtering

EVENT	SIGNAL / SUPPLY	RISING EDGE LENGTH	FALLING EDGE LENGTH
Enable, disable, or voltage select for BUCKx	ENx	3 μ s ⁽¹⁾	3 μ s ⁽¹⁾
VANA undervoltage lockout	VANA	Immediate	Immediate
Thermal warning	TDIE_WARN	20 μ s	20 μ s
Thermal shutdown	TDIE_SD	20 μ s	20 μ s
Current limit	VOUTx_ILIM	20 μ s	20 μ s
Overload	FB_B0, FB_B1, FB_B2, FB_F3	1 ms	1 ms
Power-good	FB_B0, FB_B1, FB_B2, FB_F3	20 μ s	20 μ s

(1) No glitch filtering, only synchronization.

7.4 Device Functional Modes

7.4.1 Modes of Operation

- SHUTDOWN:** The $V_{(NRST)}$ voltage is below threshold level. All switch, reference, control and bias circuitry of the LP8758-EA device are turned off.
- WAIT-ON:** The $V_{(NRST)}$ voltage is above threshold level. The reference and bias circuitry are enabled. The converter cores of the LP8758-EA device are turned off.
- READ OTP:** The main supply voltage $V_{(VANA)}$ is above $VANA_{UVLO}$ level and $V_{(NRST)}$ voltage is above threshold level. The converter cores are disabled and the reference and bias circuitry of the LP8758-EA are enabled. The OTP bits are loaded to registers.
- STANDBY:** The main supply voltage $V_{(VANA)}$ is above $VANA_{UVLO}$ level and $V_{(NRST)}$ voltage is above threshold level. The converter cores are disabled and the reference, control and bias circuitry of the LP8758-EA are enabled. All registers can be read or written by the host processor through the system serial interface. The converter cores can be enabled if needed.
- ACTIVE:** The main supply voltage $V_{(VANA)}$ is above $VANA_{UVLO}$ level and $V_{(NRST)}$ voltage is above threshold level. At least one converter core is enabled. All registers can be read or written by the host processor through the system serial interface.

The operating modes and transitions between the modes are shown in [Figure 7-7](#).

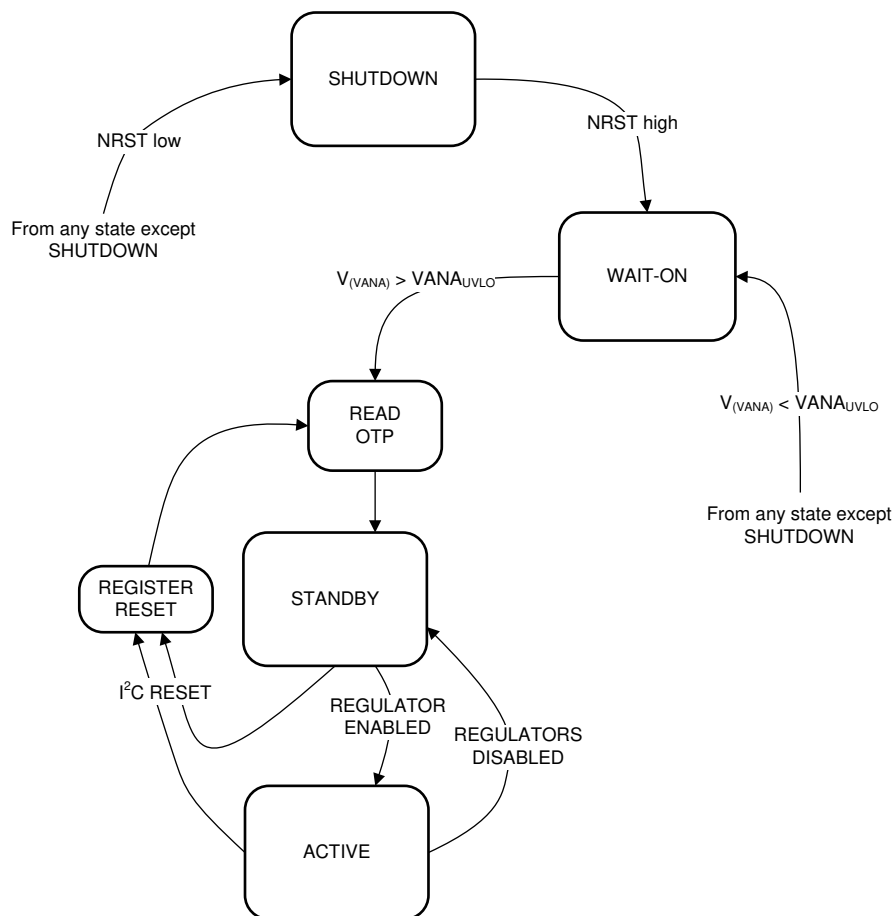

Figure 7-7. Device Operation Modes

7.5 Programming

7.5.1 I²C-Compatible Interface

The I²C-compatible synchronous serial interface provides access to the programmable functions and registers on the device. This protocol uses a two-wire interface for bidirectional communications between the devices connected to the bus. The two interface lines are the Serial Data Line (SDA), and the Serial Clock Line (SCL). Every device on the bus is assigned a unique address and acts as either a master or a slave depending on whether it generates or receives the serial clock SCL. The SCL and SDA lines must each have a pullup resistor placed somewhere on the line and remain HIGH even when the bus is idle. The LP8758-EA supports standard mode (100 kHz), fast mode (400 kHz), fast mode plus (1 MHz), and high-speed mode (3.4 MHz).

7.5.1.1 Data Validity

The data on the SDA line must be stable during the HIGH period of the clock signal (SCL). In other words, the state of the data line can only be changed when clock signal is LOW.

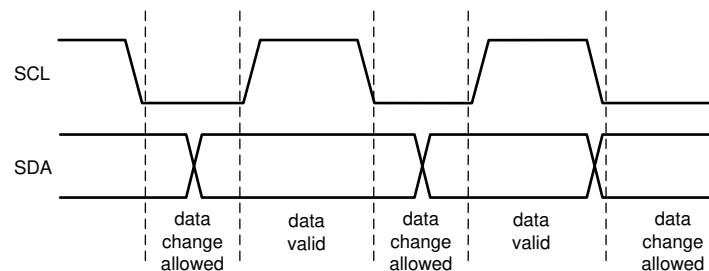

Figure 7-8. Data Validity Diagram

7.5.1.2 Start and Stop Conditions

The LP8758-EA is controlled through an I²C-compatible interface. START and STOP conditions classify the beginning and end of the I²C session. A START condition is defined as SDA transitions from HIGH to LOW while SCL is HIGH. A STOP condition is defined as SDA transition from LOW to HIGH while SCL is HIGH. The I²C master always generates the START and STOP conditions.

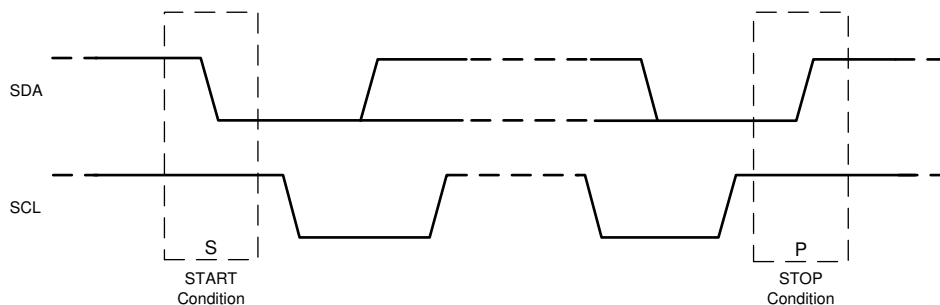
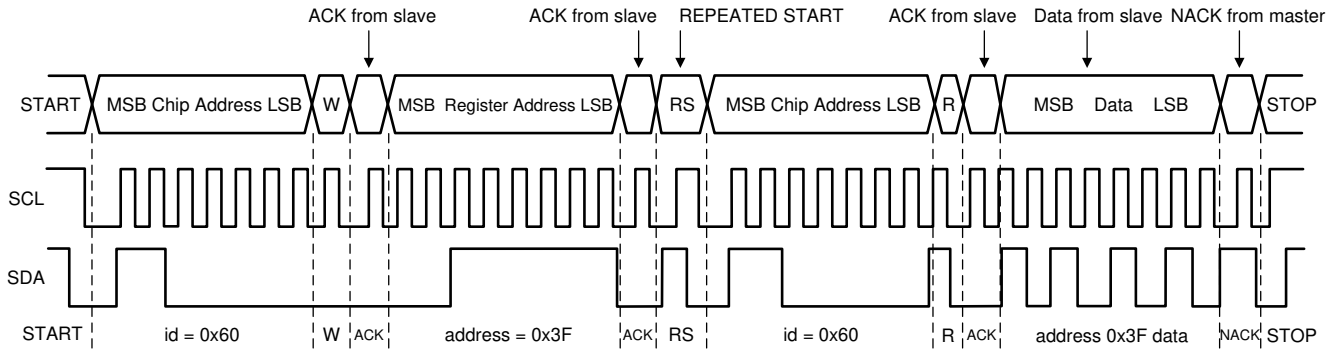

Figure 7-9. Start and Stop Sequences

The I²C bus is considered busy after a START condition and free after a STOP condition. During data transmission the I²C master can generate repeated START conditions. A START and a repeated START condition are equivalent function-wise. The data on SDA must be stable during the HIGH period of the clock signal (SCL). In other words, the state of SDA can only be changed when SCL is LOW. [Figure 7-10](#) shows the SDA and SCL signal timing for the I²C-Compatible Bus. See the [Section 6.6](#) for timing values.



When READ function is to be accomplished, a WRITE function must precede the READ function as shown above.

Figure 7-12. Read Cycle (r = read; SDA = 1), id = Device Address = 60Hex for LP8758-EA

7.5.1.4 I²C-Compatible Chip Address

The device address for the LP8758-EA is 0x60. After the START condition, the I²C master sends the 7-bit address followed by an eighth bit, read or write (R/W). R/W = 0 indicates a WRITE and R/W = 1 indicates a READ. The second byte following the device address selects the register address to which the data will be written. The third byte contains the data for the selected register.

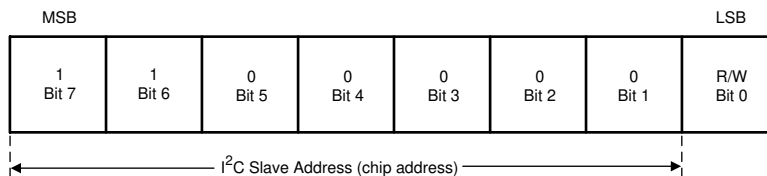

Here device address is 110 0000Bin = .

Figure 7-13. Device Address

7.5.1.5 Auto Increment Feature

The auto-increment feature allows writing several consecutive registers within one transmission. Every time an 8-bit word is sent to the LP8758-EA, the internal address index counter is incremented by one and the next register is written. Table 7-4 below shows writing sequence to two consecutive registers. Note: the auto-increment feature does not work for read.

Table 7-4. Auto-Increment Example

Master Action	Start	Device Address = 60H	Write	Register Address	Data	Data	Stop
LP8758-EA Action			ACK	ACK	ACK	ACK	

7.6 Register Maps

7.6.1 Register Descriptions

The LP8758-EA is controlled by a set of registers through the serial interface port. The device registers, their addresses and their abbreviations are listed in [Table 7-5](#). A more detailed description is given in sections [Section 7.6.1.1](#) to [Section 7.6.1.35](#).

The asterisk (*) marking indicates register bits which are updated from OTP memory during READ OTP state.

Table 7-5. Summary of LP8758-EA Control Registers

Addr	Register	Read / Write	D7	D6	D5	D4	D3	D2	D1	D0	
0x01	OTP_REV	R	OTP_ID[7:0]								
0x02	BUCK0_CTRL1	R/W	EN_BUCK0	EN_PIN_CTRL0	EN_PIN_SELECT0	EN_ROOF_FLOOR0	EN_RDIS0	Reserved	BUCK0_FPWM	Reserved	
0x03	BUCK0_CTRL2	R/W	Reserved		ILIM0[2:0]			SLEW_RATE0[2:0]			
0x04	BUCK1_CTRL1	R/W	EN_BUCK1	EN_PIN_CTRL1	EN_PIN_SELECT1	EN_ROOF_FLOOR1	EN_RDIS1	Reserved	BUCK1_FPWM	Reserved	
0x05	BUCK1_CTRL2	R/W	Reserved		ILIM1[2:0]			SLEW_RATE1[2:0]			
0x06	BUCK2_CTRL1	R/W	EN_BUCK2	EN_PIN_CTRL2	EN_PIN_SELECT2	EN_ROOF_FLOOR2	EN_RDIS2	Reserved	BUCK2_FPWM	Reserved	
0x07	BUCK2_CTRL2	R/W	Reserved		ILIM2[2:0]			SLEW_RATE2[2:0]			
0x08	BUCK3_CTRL1	R/W	EN_BUCK3	EN_PIN_CTRL3	EN_PIN_SELECT3	EN_ROOF_FLOOR3	EN_RDIS3	Reserved	BUCK3_FPWM	Reserved	
0x09	BUCK3_CTRL2	R/W	Reserved		ILIM3[2:0]			SLEW_RATE3[2:0]			
0x0A	BUCK0_VOUT	R/W	BUCK0_VSET[7:0]								
0x0B	BUCK0_FLOOR_VOUT	R/W	BUCK0_FLOOR_VSET[7:0]								
0x0C	BUCK1_VOUT	R/W	BUCK1_VSET[7:0]								
0x0D	BUCK1_FLOOR_VOUT	R/W	BUCK1_FLOOR_VSET[7:0]								
0x0E	BUCK2_VOUT	R/W	BUCK2_VSET[7:0]								
0x0F	BUCK2_FLOOR_VOUT	R/W	BUCK2_FLOOR_VSET[7:0]								
0x10	BUCK3_VOUT	R/W	BUCK3_VSET[7:0]								
0x11	BUCK3_FLOOR_VOUT	R/W	BUCK3_FLOOR_VSET[7:0]								
0x12	BUCK0_DELAY	R/W	BUCK0_SHUTDOWN_DELAY[3:0]				BUCK0_STARTUP_DELAY[3:0]				
0x13	BUCK1_DELAY	R/W	BUCK1_SHUTDOWN_DELAY[3:0]				BUCK1_STARTUP_DELAY[3:0]				
0x14	BUCK2_DELAY	R/W	BUCK2_SHUTDOWN_DELAY[3:0]				BUCK2_STARTUP_DELAY[3:0]				
0x15	BUCK3_DELAY	R/W	BUCK3_SHUTDOWN_DELAY[3:0]				BUCK3_STARTUP_DELAY[3:0]				
0x16	RESET	R/W	Reserved								SW_RESET
0x17	CONFIG	R/W	Reserved				TDIE_WARN_LEVEL	EN2_PD	EN1_PD	EN_SPREAD_SPEC	
0x18	INT_TOP	R/W	INT_BUCK3	INT_BUCK2	INT_BUCK1	INT_BUCK0	TDIE_SD	TDIE_WARN	RESET_REG	I_LOAD_READY	

Table 7-5. Summary of LP8758-EA Control Registers (continued)

Addr	Register	Read / Write	D7	D6	D5	D4	D3	D2	D1	D0		
0x19	INT_BUCK_0_1	R/W	Reserved	BUCK1_PG_INT	BUCK1_SC_INT	BUCK1_ILIM_INT	Reserved	BUCK0_PG_INT	BUCK0_SC_INT	BUCK0_ILIM_INT		
0x1A	INT_BUCK_2_3	R/W	Reserved	BUCK3_PG_INT	BUCK3_SC_INT	BUCK3_ILIM_INT	Reserved	BUCK2_PG_INT	BUCK2_SC_INT	BUCK2_ILIM_INT		
0x1B	TOP_STAT	R	Reserved				TDIE_SD_STAT	TDIE_WARN_STAT	Reserved			
0x1C	BUCK_0_1_STAT	R	BUCK1_STAT	BUCK1_PG_STAT	Reserved	BUCK1_ILIM_STAT	BUCK0_STAT	BUCK0_PG_STAT	Reserved	BUCK0_ILIM_STAT		
0x1D	BUCK_2_3_STAT	R	BUCK3_STAT	BUCK3_PG_STAT	Reserved	BUCK3_ILIM_STAT	BUCK2_STAT	BUCK2_PG_STAT	Reserved	BUCK2_ILIM_STAT		
0x1E	TOP_MASK	R/W	Reserved					TDIE_WARN_MASK	RESET_REG_MASK	I_LOAD_READY_MASK		
0x1F	BUCK_0_1_MASK	R/W	Reserved	BUCK1_PG_MASK	Reserved	BUCK1_ILIM_MASK	Reserved	BUCK0_PG_MASK	Reserved	BUCK0_ILIM_MASK		
0x20	BUCK_2_3_MASK	R/W	Reserved	BUCK3_PG_MASK	Reserved	BUCK3_ILIM_MASK	Reserved	BUCK2_PG_MASK	Reserved	BUCK2_ILIM_MASK		
0x21	SEL_I_LOAD	R/W	Reserved						LOAD_CURRENT_BUCK_SELECT[1:0]			
0x22	I_LOAD_2	R/W	Reserved						BUCK_LOAD_CURRENT[9:8]			
0x23	I_LOAD_1	R/W	BUCK_LOAD_CURRENT[7:0]									

7.6.1.1 OTP_REV

Address: 0x01

D7	D6	D5	D4	D3	D2	D1	D0
OTP_ID[7:0]							
Bits	Field	Type	Default	Description			
7:0	OTP_ID[7:0]	R	0xEA *	Identification code of the OTP EPROM version.			

7.6.1.2 BUCK0_CTRL1

Address: 0x02

D7	D6	D5	D4	D3	D2	D1	D0
EN_BUCK0	EN_PIN_CTRL0	EN_PIN_SELECT0	EN_ROOF_FLOOR0	EN_RDIS0	Reserved	BUCK0_FPWM	Reserved
Bits	Field	Type	Default	Description			
7	EN_BUCK0	R/W	1 *	Enable BUCK0 converter core: 0 - BUCK0 converter core is disabled. 1 - BUCK0 converter core is enabled.			
6	EN_PIN_CTRL0	R/W	1 *	Enable EN1/2 pin control for BUCK0: 0 - only EN_BUCK0 bit controls BUCK0. 1 - EN_BUCK0 bit AND EN1/2 pin control BUCK0.			
5	EN_PIN_SELECT0	R/W	0 *	Select which ENx pin controls BUCK0 if EN_PIN_CTRL0 = 1: 0 - EN1 pin. 1 - EN2 pin.			
4	EN_ROOF_FLOOR0	R/W	0	Enable Roof/Floor control of EN1/2 pin if EN_PIN_CTRL0 = 1: 0 - Enable/Disable (1/0) control. 1 - Roof/Floor (1/0) control.			
3	EN_RDIS0	R/W	1	Enable output discharge resistor when BUCK0 is disabled: 0 - Discharge resistor disabled. 1 - Discharge resistor enabled.			
2	Reserved	R/W	0				
1	BUCK0_FPWM	R/W	0 *	Forces the BUCK0 converter core to operate in PWM mode: 0 - Automatic transitions between PFM and PWM modes (AUTO mode). 1 - Forced to PWM operation.			
0	Reserved	R/W	0				

7.6.1.3 BUCK0_CTRL2

Address: 0x03

D7	D6	D5	D4	D3	D2	D1	D0
Reserved		ILIM0[2:0]			SLEW_RATE0[2:0]		
Bits	Field	Type	Default	Description			
7:6	Reserved	R/W	00				
5:3	ILIM0[2:0]	R/W	0x6 *	Sets the switch current limit of BUCK0. Can be programmed at any time during operation: 0x2 - 2.5 A 0x3 - 3.0 A 0x4 - 3.5 A 0x5 - 4.0 A 0x6 - 4.5 A 0x7 - 5.0 A			

Bits	Field	Type	Default	Description
2:0	SLEW_RATE0[2:0]	R/W	0x4 *	Sets the output voltage slew rate for BUCK0 converter core (rising and falling edges): 0x0 - 30 mV/μs 0x1 - 15 mV/μs 0x2 - 10 mV/μs 0x3 - 7.5 mV/μs 0x4 - 3.8 mV/μs 0x5 - 1.9 mV/μs 0x6 - 0.94 mV/μs 0x7 - 0.4 mV/μs

7.6.1.4 BUCK1_CTRL1

Address: 0x04

D7	D6	D5	D4	D3	D2	D1	D0
EN_BUCK1	EN_PIN_CTRL1	EN_PIN_SELECT1	EN_ROOF_FLOOR1	EN_RDIS1	Reserved	BUCK1_FPWM	Reserved

Bits	Field	Type	Default	Description
7	EN_BUCK1	R/W	1 *	Enable BUCK1 converter core: 0 - BUCK1 converter core is disabled. 1 - BUCK1 converter core is enabled.
6	EN_PIN_CTRL1	R/W	1 *	Enable EN1/2 pin control for BUCK1: 0 - only EN_BUCK1 bit controls BUCK1. 1 - EN_BUCK1 bit AND EN1/2 pin control BUCK1.
5	EN_PIN_SELECT1	R/W	0 *	Select which ENx pin controls BUCK1 if EN_PIN_CTRL1 = 1: 0 - EN1 pin 1 - EN2 pin.
4	EN_ROOF_FLOOR1	R/W	0	Enable Roof/Floor control of EN1/2 pin if EN_PIN_CTRL1 = 1: 0 - Enable/Disable (1/0) control. 1 - Roof/Floor (1/0) control.
3	EN_RDIS1	R/W	1	Enable output discharge resistor when BUCK1 is disabled: 0 - Discharge resistor is disabled. 1 - Discharge resistor is enabled.
2	Reserved	R/W	0	
1	BUCK1_FPWM	R/W	0 *	Forces the BUCK1 converter core to operate in PWM mode: 0 - Automatic transitions between PFM and PWM modes (AUTO mode). 1 - Forced to PWM operation.
0	Reserved	R/W	0	

7.6.1.5 BUCK1_CTRL2

Address: 0x05

D7	D6	D5	D4	D3	D2	D1	D0
Reserved		ILIM1[2:0]			SLEW_RATE1[2:0]		
Bits	Field	Type	Default	Description			
7:6	Reserved	R/W	00				
5:3	ILIM1[2:0]	R/W	0x6 *	Sets the switch current limit of BUCK1. Can be programmed at any time during operation: 0x2 - 2.5 A 0x3 - 3.0 A 0x4 - 3.5 A 0x5 - 4.0 A 0x6 - 4.5 A 0x7 - 5.0 A			
2:0	SLEW_RATE1[2:0]	R/W	0x4 *	Sets the output voltage slew rate for BUCK1 converter core (rising and falling edges): 0x0 - 30 mV/μs 0x1 - 15 mV/μs 0x2 - 10 mV/μs 0x3 - 7.5 mV/μs 0x4 - 3.8 mV/μs 0x5 - 1.9 mV/μs 0x6 - 0.94 mV/μs 0x7 - 0.4 mV/μs			

7.6.1.6 BUCK2_CTRL1

Address: 0x06

D7	D6	D5	D4	D3	D2	D1	D0
EN_BUCK2	EN_PIN_CTRL2	EN_PIN_SELECT2	EN_ROOF_FLOOR2	EN_RDIS2	Reserved	BUCK2_FPWM	Reserved
Bits	Field	Type	Default	Description			
7	EN_BUCK2	R/W	1 *	Enable BUCK2 converter core: 0 - BUCK2 converter core is disabled. 1 - BUCK2 converter core is enabled.			
6	EN_PIN_CTRL2	R/W	1 *	Enable EN1/2 pin control for BUCK2: 0 - only EN_BUCK2 bit controls BUCK2. 1 - EN_BUCK2 bit AND EN1/2 pin control BUCK2.			
5	EN_PIN_SELECT2	R/W	1 *	Select which ENx pin controls BUCK2 if EN_PIN_CTRL2 = 1: 0 - EN1 pin 1 - EN2 pin.			
4	EN_ROOF_FLOOR2	R/W	0	Enable Roof/Floor control of EN1/2 pin if EN_PIN_CTRL2 = 1: 0 - Enable/Disable (1/0) control. 1 - Roof/Floor (1/0) control.			
3	EN_RDIS2	R/W	1	Enable output discharge resistor when BUCK2 is disabled: 0 - Discharge resistor is disabled. 1 - Discharge resistor is enabled.			
2	Reserved	R/W	0				
1	BUCK2_FPWM	R/W	0 *	Forces the BUCK2 converter core to operate in PWM mode: 0 - Automatic transitions between PFM and PWM modes (AUTO mode). 1 - Forced to PWM operation.			
0	Reserved	R/W	0				

7.6.1.7 BUCK2_CTRL2

Address: 0x07

D7	D6	D5	D4	D3	D2	D1	D0
Reserved		ILIM2[2:0]			SLEW_RATE2[2:0]		
Bits	Field	Type	Default	Description			
7:6	Reserved	R/W	00				
5:3	ILIM2[2:0]	R/W	0x6 *	Sets the switch current limit of BUCK2. Can be programmed at any time during operation: 0x2 - 2.5 A 0x3 - 3.0 A 0x4 - 3.5 A 0x5 - 4.0 A 0x6 - 4.5 A 0x7 - 5.0 A			
2:0	SLEW_RATE2[2:0]	R/W	0x4 *	Sets the output voltage slew rate for BUCK2 converter core (rising and falling edges): 0x0 - 30 mV/μs 0x1 - 15 mV/μs 0x2 - 10 mV/μs 0x3 - 7.5 mV/μs 0x4 - 3.8 mV/μs 0x5 - 1.9 mV/μs 0x6 - 0.94 mV/μs 0x7 - 0.4 mV/μs			

7.6.1.8 BUCK3_CTRL1

Address: 0x08

D7	D6	D5	D4	D3	D2	D1	D0
EN_BUCK3	EN_PIN_CTRL3	EN_PIN_SELECT3	EN_ROOF_FLOOR3	EN_RDIS3	Reserved	BUCK3_FPWM	Reserved
Bits	Field	Type	Default	Description			
7	EN_BUCK3	R/W	1 *	Enable BUCK3 converter core: 0 - BUCK3 converter core is disabled. 1 - BUCK3 converter core is enabled.			
6	EN_PIN_CTRL3	R/W	1 *	Enable EN1/2 pin control for BUCK3: 0 - only EN_BUCK3 bit controls BUCK3 1 - EN_BUCK3 bit AND EN1/2 pin control BUCK3.			
5	EN_PIN_SELECT3	R/W	1 *	Select which ENx pin controls BUCK3 if EN_PIN_CTRL3 = 1: 0 - EN1 pin 1 - EN2 pin.			
4	EN_ROOF_FLOOR3	R/W	0	Enable Roof/Floor control of EN1/2 pin if EN_PIN_CTRL3 = 1: 0 - Enable/Disable (1/0) control 1 - Roof/Floor (1/0) control.			
3	EN_RDIS3	R/W	1	Enable output discharge resistor when BUCK3 is disabled: 0 - Discharge resistor is disabled. 1 - Discharge resistor is enabled.			
2	Reserved	R/W	0				
1	BUCK3_FPWM	R/W	0 *	Forces the BUCK3 converter core to operate in PWM mode: 0 - Automatic transitions between PFM and PWM modes (AUTO mode). 1 - Forced to PWM operation.			
0	Reserved	R/W	0				

7.6.1.9 BUCK3_CTRL2

Address: 0x09

D7	D6	D5	D4	D3	D2	D1	D0
Reserved		ILIM3[2:0]			SLEW_RATE3[2:0]		
Bits	Field	Type	Default	Description			
7:6	Reserved	R/W	00				
5:3	ILIM3[2:0]	R/W	0x6 *	Sets the switch current limit of BUCK3. Can be programmed at any time during operation: 0x2 - 2.5 A 0x3 - 3.0 A 0x4 - 3.5 A 0x5 - 4.0 A 0x6 - 4.5 A 0x7 - 5.0 A			
2:0	SLEW_RATE3[2:0]	R/W	0x4 *	Sets the output voltage slew rate for BUCK3 converter core (rising and falling edges): 0x0 - 30 mV/μs 0x1 - 15 mV/μs 0x2 - 10 mV/μs 0x3 - 7.5 mV/μs 0x4 - 3.8 mV/μs 0x5 - 1.9 mV/μs 0x6 - 0.94 mV/μs 0x7 - 0.4 mV/μs			

7.6.1.10 BUCK0_VOUT

Address: 0x0A

D7	D6	D5	D4	D3	D2	D1	D0
BUCK0_VSET[7:0]							
Bits	Field	Type	Default	Description			
7:0	BUCK0_VSET[7:0]	R/W	0x37 *	Sets the output voltage of BUCK0 converter core (Default 900 mV) 0.5 V - 0.73 V, 10 mV steps 0x00 - 0.5 V ... 0x17 - 0.73 V 0.73 V - 1.4 V, 5 mV steps 0x18 - 0.735 V ... 0x9D - 1.4 V 1.4 V - 3.36 V, 20 mV steps 0x9E - 1.42 V ... 0xFF - 3.36 V			

7.6.1.11 BUCK0_FLOOR_VOUT

Address: 0x0B

D7	D6	D5	D4	D3	D2	D1	D0
BUCK0_FLOOR_VSET[7:0]							
Bits	Field	Type	Default	Description			
7:0	BUCK0_FLOOR_VSET[7:0]	R/W	0x00	Sets the output voltage of BUCK0 converter core when Floor state is used: 0.5 V - 0.73 V, 10 mV steps 0x00 - 0.5 V ... 0x17 - 0.73 V 0.73 V - 1.4 V, 5 mV steps 0x18 - 0.735 V ... 0x9D - 1.4 V 1.4 V - 3.36 V, 20 mV steps 0x9E - 1.42 V ... 0xFF - 3.36 V			

7.6.1.12 BUCK1_VOUT

Address: 0x0C

D7	D6	D5	D4	D3	D2	D1	D0
BUCK1_VSET[7:0]							
Bits	Field	Type	Default	Description			
7:0	BUCK1_VSET[7:0]	R/W	0x37 *	Sets the output voltage of BUCK1 converter core (Default 1200 mV): 0.5 V - 0.73 V, 10 mV steps 0x00 - 0.5 V ... 0x17 - 0.73 V 0.73 V - 1.4 V, 5 mV steps 0x18 - 0.735 V ... 0x9D - 1.4 V 1.4 V - 3.36 V, 20 mV steps 0x9E - 1.42 V ... 0xFF - 3.36 V			

7.6.1.13 BUCK1_FLOOR_VOUT

Address: 0x0D

D7	D6	D5	D4	D3	D2	D1	D0
BUCK1_FLOOR_VSET[7:0]							

Bits	Field	Type	Default	Description
7:0	BUCK1_FLOOR_VSET[7:0]	R/W	0x00	Sets the output voltage of BUCK1 converter core when the Floor state is used: 0.5 V - 0.73 V, 10 mV steps 0x00 - 0.5V ... 0x17 - 0.73 V 0.73 V - 1.4 V, 5 mV steps 0x18 - 0.735 V ... 0x9D - 1.4 V 1.4 V - 3.36 V, 20 mV steps 0x9E - 1.42 V ... 0xFF - 3.36 V

7.6.1.14 BUCK2_VOUT

Address: 0x0E

D7	D6	D5	D4	D3	D2	D1	D0
----	----	----	----	----	----	----	----

BUCK2_VSET[7:0]							
-----------------	--	--	--	--	--	--	--

Bits	Field	Type	Default	Description
7:0	BUCK2_VSET[7:0]	R/W	0x37 *	Sets the output voltage of BUCK2 converter core (Default 1800 mV): 0.5 V - 0.73 V, 10 mV steps 0x00 - 0.5V ... 0x17 - 0.73 V 0.73 V - 1.4 V, 5 mV steps 0x18 - 0.735 V ... 0x9D - 1.4 V 1.4 V - 3.36 V, 20 mV steps 0x9E - 1.42 V ... 0xFF - 3.36 V

7.6.1.15 BUCK2_FLOOR_VOUT

Address: 0x0F

D7	D6	D5	D4	D3	D2	D1	D0
----	----	----	----	----	----	----	----

BUCK2_FLOOR_VSET[7:0]							
-----------------------	--	--	--	--	--	--	--

Bits	Field	Type	Default	Description
7:0	BUCK2_FLOOR_VSET[7:0]	R/W	0x00	Sets the output voltage of BUCK2 converter core when the Floor state is used: 0.5 V - 0.73 V, 10 mV steps 0x00 - 0.5 V ... 0x17 - 0.73 V 0.73 V - 1.4 V, 5 mV steps 0x18 - 0.735 V ... 0x9D - 1.4 V 1.4 V - 3.36 V, 20 mV steps 0x9E - 1.42 V ... 0xFF - 3.36 V

7.6.1.16 BUCK3_VOUT

Address: 0x10

D7	D6	D5	D4	D3	D2	D1	D0
BUCK3_VSET[7:0]							
Bits	Field	Type	Default	Description			
7:0	BUCK3_VSET[7:0]	R/W	0x37 *	Sets the output voltage of BUCK3 converter core (Default 2700 mV) 0.5 V - 0.73 V, 10 mV steps 0x00 - 0.5 V ... 0x17 - 0.73 V 0.73 V - 1.4 V, 5 mV steps 0x18 - 0.735 V ... 0x9D - 1.4 V 1.4 V - 3.36 V, 20 mV steps 0x9E - 1.42 V ... 0xFF - 3.36 V			

7.6.1.17 BUCK3_FLOOR_VOUT

Address: 0x11

D7	D6	D5	D4	D3	D2	D1	D0
BUCK3_FLOOR_VSET[7:0]							
Bits	Field	Type	Default	Description			
7:0	BUCK3_FLOOR_VSET[7:0]	R/W	0x00	Sets the output voltage of BUCK3 converter core when Floor state is used: 0.5 V - 0.73 V, 10 mV steps 0x00 - 0.5 V ... 0x17 - 0.73 V 0.73 V - 1.4 V, 5 mV steps 0x18 - 0.735 V ... 0x9D - 1.4 V 1.4 V - 3.36 V, 20 mV steps 0x9E - 1.42 V ... 0xFF - 3.36 V			

7.6.1.18 BUCK0_DELAY

Address: 0x12

D7	D6	D5	D4	D3	D2	D1	D0
BUCK0_SHUTDOWN_DELAY[3:0]				BUCK0_STARTUP_DELAY[3:0]			
Bits	Field	Type	Default	Description			
7:4	BUCK0_SHUTDOWN_DELAY[3:0]	R/W	0x0 *	Shutdown delay of BUCK0 from falling edge of the ENx signal: 0x0 - 0 ms 0x1 - 1 ms ... 0xF - 15 ms			

Bits	Field	Type	Default	Description
3:0	BUCK0_STARTUP_DELAY[3:0]	R/W	0x0 *	Startup delay of BUCK0 from rising edge of the ENx signal: 0x0 - 0 ms 0x1 - 1 ms ... 0xF - 15 ms

7.6.1.19 BUCK1_DELAY

Address: 0x13

D7	D6	D5	D4	D3	D2	D1	D0
BUCK1_SHUTDOWN_DELAY[3:0]				BUCK1_STARTUP_DELAY[3:0]			

Bits	Field	Type	Default	Description
7:4	BUCK1_SHUTDOWN_DELAY[3:0]	R/W	0x0 *	Shutdown delay of BUCK1 from falling edge of the ENx signal: 0x0 - 0 ms 0x1 - 1 ms ... 0xF - 15 ms
3:0	BUCK1_STARTUP_DELAY[3:0]	R/W	0x0 *	Startup delay of BUCK1 from rising edge of the ENx signal: 0x0 - 0 ms 0x1 - 1 ms ... 0xF - 15 ms

7.6.1.20 BUCK2_DELAY

Address: 0x14

D7	D6	D5	D4	D3	D2	D1	D0
BUCK2_SHUTDOWN_DELAY[3:0]				BUCK2_STARTUP_DELAY[3:0]			

Bits	Field	Type	Default	Description
7:4	BUCK2_SHUTDOWN_DELAY[3:0]	R/W	0x0 *	Shutdown delay of BUCK2 from falling edge of the ENx signal: 0x0 - 0 ms 0x1 - 1 ms ... 0xF - 15 ms
3:0	BUCK2_STARTUP_DELAY[3:0]	R/W	0x0 *	Start-up delay of BUCK2 from rising edge of the ENx signal: 0x0 - 0 ms 0x1 - 1 ms ... 0xF - 15 ms

7.6.1.21 BUCK3_DELAY

Address: 0x15

D7	D6	D5	D4	D3	D2	D1	D0
BUCK3_SHUTDOWN_DELAY[3:0]				BUCK3_STARTUP_DELAY[3:0]			

Bits	Field	Type	Default	Description
7:4	BUCK3_SHUTDOWN_DELAY[3:0]	R/W	0x0 *	Shutdown delay of BUCK3 from falling edge of the ENx signal: 0x0 - 0 ms 0x1 - 1 ms ... 0xF - 15 ms

Bits	Field	Type	Default	Description
3:0	BUCK3_STARTUP_DELAY[3:0]	R/W	0x0 *	Start-up delay of BUCK3 from rising edge of the ENx signal: 0x0 - 0 ms 0x1 - 1 ms ... 0xF - 15 ms

7.6.1.22 RESET

Address: 0x16

D7	D6	D5	D4	D3	D2	D1	D0
----	----	----	----	----	----	----	----

Reserved						SW_RESET
----------	--	--	--	--	--	----------

Bits	Field	Type	Default	Description
7:1	Reserved	R/W	0000 000	
0	SW_RESET	R/W	0	Software commanded reset. When written to 1, the registers are reset to default values, OTP memory is read, and the I ² C interface is reset. The bit is automatically cleared.

7.6.1.23 CONFIG

Address: 0x17

D7	D6	D5	D4	D3	D2	D1	D0
Reserved				TDIE_WARN_LEVEL	EN2_PD	EN1_PD	EN_SPREAD_SPEC

Bits	Field	Type	Default	Description
7:4	Reserved	R/W	0000	
3	TDIE_WARN_LEVEL	R/W	0	Thermal warning threshold level. 0 - 125°C 1 - 105°C
2	EN2_PD	R/W	1	Selects the pulldown resistor on the EN2 input pin. 0 - Pulldown resistor is disabled. 1 - Pulldown resistor is enabled.
1	EN1_PD	R/W	1	Selects the pull down resistor on the EN1 input pin. 0 - Pulldown resistor is disabled. 1 - Pulldown resistor is enabled.
0	EN_SPREAD_SPEC	R/W	0	Enable spread-spectrum feature: 0 - Disabled 1 - Enabled

7.6.1.24 INT_TOP

Address: 0x18

D7	D6	D5	D4	D3	D2	D1	D0
INT_BUCK3	INT_BUCK2	INT_BUCK1	INT_BUCK0	TDIE_SD	TDIE_WARN	RESET_REG	I_LOAD_READY

Bits	Field	Type	Default	Description
7	INT_BUCK3	R	0	Interrupt indicating that output BUCK3 has a pending interrupt. The reason for the interrupt is indicated in INT_BUCK3 register. This bit is cleared automatically when INT_BUCK3 register is cleared to 0x00.
6	INT_BUCK2	R	0	Interrupt indicating that output BUCK2 has a pending interrupt. The reason for the interrupt is indicated in INT_BUCK2 register. This bit is cleared automatically when INT_BUCK2 register is cleared to 0x00.
5	INT_BUCK1	R	0	Interrupt indicating that output BUCK1 has a pending interrupt. The reason for the interrupt is indicated in INT_BUCK1 register. This bit is cleared automatically when INT_BUCK1 register is cleared to 0x00.
4	INT_BUCK0	R	0	Interrupt indicating that output BUCK0 has a pending interrupt. The reason for the interrupt is indicated in INT_BUCK0 register. This bit is cleared automatically when INT_BUCK0 register is cleared to 0x00.
3	TDIE_SD	R/W	0	Latched status bit indicating that the die junction temperature has exceeded the thermal shutdown level. The converter cores have been disabled if they were enabled. The converter cores cannot be enabled if this bit is active. The actual status of the thermal warning is indicated by the TOP_STAT.TDIE_SD_STAT bit. Write 1 to clear interrupt.
2	TDIE_WARN	R/W	0	Latched status bit indicating that the die junction temperature has exceeded the thermal warning level. The actual status of the thermal warning is indicated by TOP_STAT.TDIE_WARN_STAT bit. Write 1 to clear interrupt.
1	RESET_REG	R/W	0	Latched status bit indicating that either startup (NRST rising edge) has done, VANA supply voltage has been below undervoltage threshold level or the host has requested a reset (RESET.SW_RESET). The converter cores have been disabled, and registers are reset to default values and the normal startup procedure is done. Write 1 to clear interrupt.

Bits	Field	Type	Default	Description
0	I_LOAD_READY	R/W	0	Latched status bit indicating that the load current measurement result is available in I_LOAD_1 and I_LOAD_2 registers. Write 1 to clear interrupt.

7.6.1.25 INT_BUCK_0_1

Address: 0x19

D7	D6	D5	D4	D3	D2	D1	D0
Reserved	BUCK1_PG_INT	BUCK1_SC_INT	BUCK1_ILIM_INT	Reserved	BUCK0_PG_INT	BUCK0_SC_INT	BUCK0_ILIM_INT

Bits	Field	Type	Default	Description
7	Reserved	R/W	0	
6	BUCK1_PG_INT	R/W	0	Latched status bit indicating that BUCK1 output voltage has reached power-good threshold level. Write 1 to clear.
5	BUCK1_SC_INT	R/W	0	Latched status bit indicating that the BUCK1 output voltage has fallen below 0.35-V level during operation or BUCK1 output didn't reach 0.35-V level in 1 ms from enable. Write 1 to clear.
4	BUCK1_ILIM_INT	R/W	0	Latched status bit indicating that output current limit has been active. Write 1 to clear.
3	Reserved	R/W	0	
2	BUCK0_PG_INT	R/W	0	Latched status bit indicating that BUCK0 output voltage has reached powergood threshold level. Write 1 to clear.
1	BUCK0_SC_INT	R/W	0	Latched status bit indicating that the BUCK0 output voltage has fallen below 0.35-V level during operation or BUCK0 output didn't reach 0.35-V level in 1 ms from enable. Write 1 to clear.
0	BUCK0_ILIM_INT	R/W	0	Latched status bit indicating that output current limit has been active. Write 1 to clear.

7.6.1.26 INT_BUCK_2_3

Address: 0x1A

D7	D6	D5	D4	D3	D2	D1	D0
Reserved	BUCK3_PG_INT	BUCK3_SC_INT	BUCK3_ILIM_INT	Reserved	BUCK2_PG_INT	BUCK2_SC_INT	BUCK2_ILIM_INT

Bits	Field	Type	Default	Description
7	Reserved	R/W	0	
6	BUCK3_PG_INT	R/W	0	Latched status bit indicating that BUCK3 output voltage has reached power-good threshold level. Write 1 to clear.
5	BUCK3_SC_INT	R/W	0	Latched status bit indicating that the BUCK3 output voltage has fallen below 0.35-V level during operation or BUCK3 output didn't reach 0.35-V level in 1 ms from enable. Write 1 to clear.
4	BUCK3_ILIM_INT	R/W	0	Latched status bit indicating that output current limit has been active. Write 1 to clear.
3	Reserved	R/W	0	
2	BUCK2_PG_INT	R/W	0	Latched status bit indicating that BUCK2 output voltage has reached powergood threshold level. Write 1 to clear.
1	BUCK2_SC_INT	R/W	0	Latched status bit indicating that the BUCK2 output voltage has fallen below 0.35 V level during operation or BUCK2 output didn't reach 0.35-V level in 1 ms from enable. Write 1 to clear.
0	BUCK2_ILIM_INT	R/W	0	Latched status bit indicating that output current limit has been active. Write 1 to clear.

7.6.1.27 TOP_STAT

Address: 0x1B

D7	D6	D5	D4	D3	D2	D1	D0
Reserved				TDIE_SD_STAT	TDIE_WARN_STAT	Reserved	
Bits	Field	Type	Default	Description			
7:4	Reserved	R	0000				
3	TDIE_SD_STAT	R	0	Status bit indicating the status of thermal shutdown: 0 - Die temperature below the thermal shutdown level. 1 - Die temperature above the thermal shutdown level.			
2	TDIE_WARN_STAT	R	0	Status bit indicating the status of thermal warning: 0 - Die temperature below the thermal warning level. 1 - Die temperature above the thermal warning level.			
1:0	Reserved	R	00				

7.6.1.28 BUCK_0_1_STAT

Address: 0x1C

D7	D6	D5	D4	D3	D2	D1	D0
BUCK1_STAT	BUCK1_PG_STAT	Reserved	BUCK1_ILIM_STAT	BUCK0_STAT	BUCK0_PG_STAT	Reserved	BUCK0_ILIM_STAT
Bits	Field	Type	Default	Description			
7	BUCK1_STAT	R	0	Status bit indicating the enable or disable status of BUCK1: 0 - BUCK1 converter core is disabled. 1 - BUCK1 converter core is enabled.			
6	BUCK1_PG_STAT	R	0	Status bit indicating BUCK1 output voltage validity (raw status): 0 - BUCK1 output is above power-good threshold level 1 - BUCK1 output is below power-good threshold level.			
5	Reserved	R	0				
4	BUCK1_ILIM_STAT	R	0	Status bit indicating BUCK1 current limit status (raw status): 0 - BUCK1 output current is below current limit level. 1 - BUCK1 output current limit is active.			
3	BUCK0_STAT	R	0	Status bit indicating the enable or disable status of BUCK0: 0 - BUCK0 converter core is disabled. 1 - BUCK0 converter core is enabled.			
2	BUCK0_PG_STAT	R	0	Status bit indicating BUCK0 output voltage validity (raw status): 0 - BUCK0 output is above the power-good threshold level. 1 - BUCK0 output is below the power-good threshold level.			
1	Reserved	R	0				
0	BUCK0_ILIM_STAT	R	0	Status bit indicating BUCK0 current limit status (raw status): 0 - BUCK0 output current is below the current limit level. 1 - BUCK0 output current limit is active.			

7.6.1.29 BUCK_2_3_STAT

Address: 0x1D

D7	D6	D5	D4	D3	D2	D1	D0
BUCK3_STAT	BUCK3_PG_STAT	Reserved	BUCK3_ILIM_STAT	BUCK2_STAT	BUCK2_PG_STAT	Reserved	BUCK2_ILIM_STAT
Bits	Field	Type	Default	Description			
7	BUCK3_STAT	R	0	Status bit indicating the enable or disable status of BUCK3: 0 - BUCK3 converter core is disabled. 1 - BUCK3 converter core is enabled.			
6	BUCK3_PG_STAT	R	0	Status bit indicating BUCK3 output voltage validity (raw status): 0 - BUCK3 output is above power-good threshold level. 1 - BUCK3 output is below power-good threshold level.			
5	Reserved	R	0				
4	BUCK3_ILIM_STAT	R	0	Status bit indicating BUCK3 current limit status (raw status): 0 - BUCK3 output current is below current limit level. 1 - BUCK3 output current limit is active.			
3	BUCK2_STAT	R	0	Status bit indicating the enable or disable status of BUCK2: 0 - BUCK2 converter core is disabled. 1 - BUCK2 converter core is enabled.			
2	BUCK2_PG_STAT	R	0	Status bit indicating BUCK2 output voltage validity (raw status): 0 - BUCK2 output is above power-good threshold level. 1 - BUCK2 output is below power-good threshold level.			
1	Reserved	R	0				
0	BUCK2_ILIM_STAT	R	0	Status bit indicating BUCK2 current limit status (raw status): 0 - BUCK2 output current is below current limit level. 1 - BUCK2 output current limit is active.			

7.6.1.30 TOP_MASK

Address: 0x1E

D7	D6	D5	D4	D3	D2	D1	D0
Reserved					TDIE_WARN_MASK	RESET_REG_MASK	I_LOAD_READY_MASK
Bits	Field	Type	Default	Description			
7:3	Reserved	R/W	0000 0				
2	TDIE_WARN_MASK	R/W	0 *	Masking for thermal warning interrupt INT_TOP.TDIE_WARN: 0 - Interrupt is generated. 1 - Interrupt is not generated. This bit does not affect TOP_STAT.TDIE_WARN_STAT status bit.			
1	RESET_REG_MASK	R/W	1 *	Masking for register reset interrupt INT_TOP.RESET_REG: 0 - Interrupt is generated. 1 - Interrupt is not generated.			
0	I_LOAD_READY_MASK	R/W	1 *	Masking for load current measurement ready interrupt INT_TOP.I_LOAD_READY: 0 - Interrupt is generated. 1 - Interrupt is not generated.			

7.6.1.31 BUCK_0_1_MASK

Address: 0x1F

D7	D6	D5	D4	D3	D2	D1	D0
Reserved	BUCK1_PG_MASK	Reserved	BUCK1_ILIM_MASK	Reserved	BUCK0_PG_MASK	Reserved	BUCK0_ILIM_MASK

Bits	Field	Type	Default	Description
7	Reserved	R/W	0	
6	BUCK1_PG_MASK	R/W	1 *	Masking for BUCK1 power-good interrupt INT_BUCK_0_1.BUCK1_PG_INT: 0 - Interrupt is generated. 1 - Interrupt is not generated. This bit does not affect the BUCK_0_1_STAT.BUCK1_PG_STAT status bit.
5	Reserved	R	0	
4	BUCK1_ILIM_MASK	R/W	1 *	Masking for BUCK1 current limit detection interrupt INT_BUCK_0_1.BUCK1_ILIM_INT: 0 - Interrupt is generated. 1 - Interrupt is not generated. This bit does not affect the BUCK_0_1_STAT.BUCK1_ILIM_STAT status bit.
3	Reserved	R/W	0	
2	BUCK0_PG_MASK	R/W	1 *	Masking for BUCK0 power-good interrupt INT_BUCK_0_1.BUCK0_PG_INT: 0 - Interrupt is generated. 1 - Interrupt is not generated. This bit does not affect the BUCK_0_1_STAT.BUCK1_PG_STAT status bit.
1	Reserved	R	0	
0	BUCK0_ILIM_MASK	R/W	1 *	Masking for BUCK0 current limit detection interrupt INT_BUCK_0_1.BUCK0_ILIM_INT: 0 - Interrupt is generated. 1 - Interrupt is not generated. This bit does not affect the BUCK_0_1_STAT.BUCK1_ILIM_STAT status bit.

7.6.1.32 BUCK_2_3_MASK

Address: 0x20

D7	D6	D5	D4	D3	D2	D1	D0
Reserved	BUCK3_PG_MASK	Reserved	BUCK3_ILIM_MASK	Reserved	BUCK2_PG_MASK	Reserved	BUCK2_ILIM_MASK

Bits	Field	Type	Default	Description
7	Reserved	R/W	0	
6	BUCK3_PG_MASK	R/W	1 *	Masking for BUCK3 power-good interrupt INT_BUCK_2_3.BUCK3_PG_INT: 0 - Interrupt is generated. 1 - Interrupt is not generated. This bit does not affect the BUCK_2_3_STAT.BUCK3_PG_STAT status bit.
5	Reserved	R	0	
4	BUCK3_ILIM_MASK	R/W	1 *	Masking for BUCK3 current limit detection interrupt INT_BUCK_2_3.BUCK3_ILIM_INT: 0 - Interrupt is generated. 1 - Interrupt is not generated. This bit does not affect the BUCK_2_3_STAT.BUCK3_ILIM_STAT status bit.
3	Reserved	R/W	0	
2	BUCK2_PG_MASK	R/W	1 *	Masking for BUCK2 power-good interrupt INT_BUCK_2_3.BUCK2_PG_INT: 0 - Interrupt is generated. 1 - Interrupt is not generated. This bit does not affect the BUCK_2_3_STAT.BUCK1_PG_STAT status bit.
1	Reserved	R	0	

Bits	Field	Type	Default	Description
0	BUCK2_ILIM_MASK	R/W	1 *	Masking for BUCK2 current limit detection interrupt INT_BUCK_2_3.BUCK2_ILIM_INT: 0 - Interrupt is generated. 1 - Interrupt is not generated. This bit does not affect the BUCK_2_3_STAT.BUCK1_ILIM_STAT status bit.

7.6.1.33 SEL_I_LOAD

Address: 0x21

D7	D6	D5	D4	D3	D2	D1	D0
Reserved						LOAD_CURRENT_BUCK_SELECT[1:0]	
Bits	Field	Type	Default	Description			
7:2	Reserved	R/W	00 0000				
1:0	LOAD_CURRENT_BUCK_SELECT [1:0]	R/W	0x0	Start the current measurement on the selected converter core: 0x0 - BUCK0 0x1 - BUCK1 0x2 - BUCK2 0x3 - BUCK3 The measurement is started when this register is written.			

7.6.1.34 I_LOAD_2

Address: 0x22

D7	D6	D5	D4	D3	D2	D1	D0
Reserved						BUCK_LOAD_CURRENT[9:8]	
Bits	Field	Type	Default	Description			
7:2	Reserved	R	00 0000				
1:0	BUCK_LOAD_CURRENT[9:8]	R	0x0	This register describes 2 MSB bits of the average load current on the selected converter core with a resolution of 20 mA per LSB and a maximum 20 A current.			

7.6.1.35 I_LOAD_1

Address: 0x23

D7	D6	D5	D4	D3	D2	D1	D0
BUCK_LOAD_CURRENT[7:0]							
Bits	Field	Type	Default	Description			
7:0	BUCK_LOAD_CURRENT[7:0]	R	0x0	This register describes 8 LSB bits of the average load current on selected converter core with a resolution of 20 mA per LSB and maximum 20-A current.			

8 Application and Implementation

Note

Information in the following applications sections is not part of the TI component specification, and TI does not warrant its accuracy or completeness. TI's customers are responsible for determining suitability of components for their purposes, as well as validating and testing their design implementation to confirm system functionality.

8.1 Application Information

The LP8758-EA is designed for applications powered from a 2.5-V to 5.5-V input supply that require multiple power rails. The device provides four step-down converters. All the step-down converters support dynamic voltage scaling through I²C interface to provide optimum power savings. The power sequencing of the four output voltage rails is programmable.

8.2 Typical Application

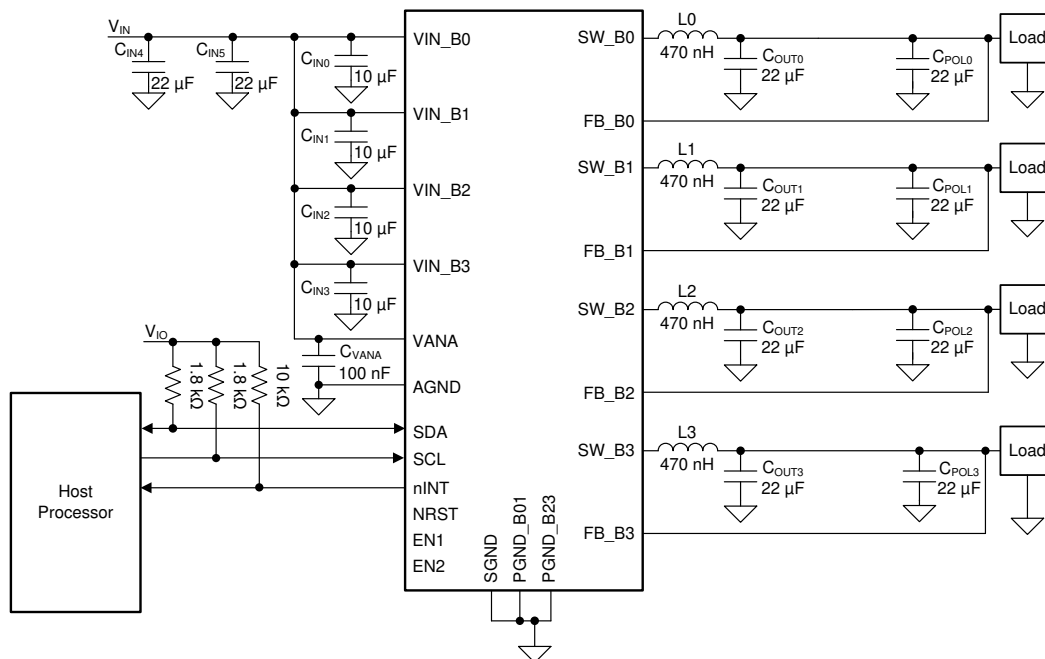

Figure 8-1. LP8758-EA Typical Application Circuit

8.2.1 Design Requirements

Table 8-1. Design Parameters

DESIGN PARAMETER	EXAMPLE VALUE
Input voltage	3.3 V
Output voltages	1000 mV, 1200 mV, 1800 mV, and 2500 mV
Converter operation mode	Auto mode (PWM-PFM)
Maximum load currents	1.5 A, 2.25 A, 3 A, and 3 A
Inductor current limits	2.5 A, 3.5 A, 4.5 A, and 4.5 A

8.2.2 Detailed Design Procedure

The performance of the LP8758-EA device depends greatly on the care taken in designing the printed circuit board (PCB). The use of low-inductance and low serial-resistance ceramic capacitors is strongly recommended, while proper grounding is crucial. Attention must be given to decoupling the power supplies. Decoupling

capacitors must be connected close to the device and between the power and ground pins to support high peak currents being drawn from system power rail during turnon of the switching MOSFETs. Keep input and output traces as short as possible, because trace inductance, resistance, and capacitance can easily become the performance limiting items. The separate power pins VIN_Bx are not connected together internally. The VIN_Bx power connections must be connected together outside the package using power plane construction.

8.2.2.1 Application Components

8.2.2.1.1 Inductor Selection

DC bias current characteristics of inductors must be considered. Different manufacturers follow different saturation current rating specifications, so attention must be given to details. DC bias curves should be requested from manufacturers as part of the inductor selection process. Minimum effective value of inductance to ensure good performance is 0.33 μH at maximum load current over the operating temperature range of the inductor. The DC resistance of the inductor must be less than 0.05 Ω for good efficiency at high-current condition. The inductor AC loss (resistance) also affects conversion efficiency. Higher Q factor at switching frequency usually gives better efficiency at light load to middle load. See [Table 8-2](#). Shielded inductors are preferred as they radiate less noise.

Table 8-2. Recommended Inductors

MANUFACTURER	PART NUMBER	VALUE (μH)	DIMENSIONS L \times W \times H (mm)	DCR (m Ω)
MURATA	DFE201610E-R47M=P2	0.47	2 \times 1.6 \times 1	26 (typical), 32 (maximum)
TDK	VLS252010HBX-R47M	0.47	2.5 \times 2 \times 1	29 (typical), 35 (maximum)
TDK	TFM2016GHM-0R47M	0.47	2 \times 1.6 \times 1	46 (maximum)
TOKO	DFF322512C R47	0.47	3.2 \times 2.5 \times 1.2	21 (typical), 31 (maximum)

8.2.2.1.2 Input Capacitor Selection

A ceramic input capacitor of 10 μF , 6.3 V is sufficient for most applications. Place the power input capacitor as close as possible to the VIN_Bx pin and PGND_Bx pin of the device. A larger value or higher voltage rating may be used to improve input voltage filtering. Use X7R or X5R types; *do not use Y5V or F*. DC bias characteristics of ceramic capacitors must be considered when selecting case sizes like 0402. Minimum effective input capacitance to ensure good performance is 1.9 μF per buck input at maximum input voltage DC bias including tolerances and over ambient temp range, assuming that there are at least 22 μF of additional capacitance common for all the power input pins on the system power rail. See [Table 8-3](#).

The input filter capacitor supplies current to the high-side FET switch in the first half of each cycle and reduces voltage ripple imposed on the input power source. A ceramic capacitor's low equivalent series resistance (ESR) provides the best noise filtering of the input voltage spikes due to this rapidly changing current. Select an input filter capacitor with sufficient ripple current rating.

The VANA input is used to supply analog and digital circuits in the device. See recommended components from [Table 8-4](#) for VANA input supply filtering.

Table 8-3. Recommended Power Input Capacitors (X5R Dielectric)

MANUFACTURER	PART NUMBER	VALUE	CASE SIZE	DIMENSIONS L \times W \times H (mm)	VOLTAGE RATING (V)
Murata	GRM188R60J106ME47	10 μF (20%)	0603	1.6 \times 0.8 \times 0.8	6.3

Table 8-4. Recommended VANA Supply Filtering Components

MANUFACTURER	PART NUMBER	VALUE	CASE SIZE	DIMENSIONS L \times W \times H (mm)	VOLTAGE RATING (V)
Samsung	CL03A104KP3NNNC	100 nF (10%)	0201	0.6 \times 0.3 \times 0.3	10
Murata	GRM033R61A104KE84	100 nF (10%)	0201	0.6 \times 0.3 \times 0.3	6.3

8.2.2.1.3 Output Capacitor Selection

Use ceramic capacitors, X7R or X5R types; do not use Y5V or F. DC bias voltage characteristics of ceramic capacitors must be considered. DC bias characteristics vary from manufacturer to manufacturer, and DC bias curves should be requested from them as part of the capacitor selection process. The output filter capacitor smooths out current flow from the inductor to the load, helps maintain a steady output voltage during transient

load changes and reduces output voltage ripple. These capacitors must be selected with sufficient capacitance and sufficiently low ESR and ESL to perform these functions. The minimum effective output capacitance to ensure good performance is 10 μF per output voltage rail at the output voltage DC bias, including tolerances and over ambient temperature range.

The output voltage ripple is caused by the charging and discharging of the output capacitor and also due to its R_{ESR} . The R_{ESR} is frequency dependent (as well as temperature dependent); make sure the value used for selection process is at the switching frequency of the part. See [Table 8-5](#).

A higher output capacitance improves the load step behavior and reduces the output voltage ripple as well as decreases the PFM switching frequency. For most applications one 22- μF 0603 capacitor for C_{OUT} per voltage rail is suitable. A point-of-load (POL) capacitance C_{POL} can be added as shown in [Figure 8-1](#). Although the loop compensation of the converter can be programmed to adapt to virtually several hundreds of microfarads C_{OUT} , it is preferable for C_{OUT} to be < 50 μF . Choosing higher than that is not necessarily of any benefit. Note: the output capacitor may be the limiting factor in the output voltage ramp, especially for very large (> 100 μF) output capacitors. For large output capacitors, the output voltage might be slower than the programmed ramp rate at voltage transitions, because of the higher energy stored on the output capacitance. Also at start-up, the time required to charge the output capacitor to target value might be longer. At shutdown, if the output capacitor is discharged by the internal discharge resistor, more time is required to settle V_{OUT} down as a consequence of the increased time constant.

Table 8-5. Recommended Output Capacitors (X5R Dielectric)

MANUFACTURER	PART NUMBER	VALUE	CASE SIZE	DIMENSIONS L × W × H (mm)	VOLTAGE RATING (V)
Samsung	CL10A226MP8NUNE	22 μF (20%)	0603	1.6 × 0.8 × 0.8	10
Murata	GRM188R60J226MEA0	22 μF (20%)	0603	1.6 × 0.8 × 0.8	6.3

8.2.3 Application Curves

Measurements are done using typical application set up with connections shown in [Figure 8-1](#). Graphs may not reflect the OTP default settings. Unless otherwise specified: $V_{IN} = 3.7\text{ V}$, $V_{(NRST)} = 1.8\text{ V}$, $T_A = 25\text{ }^\circ\text{C}$, $f_{SW} = 3\text{ MHz}$, $L = 470\text{ nH}$ (TDK VLS252010HBX-R47M), $I_{LIM\ FWD}$ set to maximum 5 A.

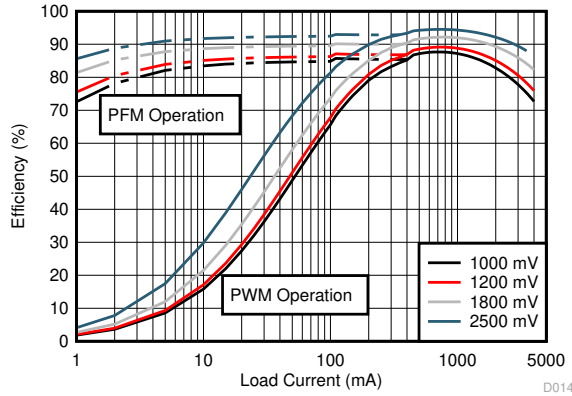

$V_{IN} = 3.7\text{ V}$

V_{OUT} settings = 1000 mV, 1200 mV, 1800 mV, and 2500 mV

Figure 8-2. Efficiency vs Load Current

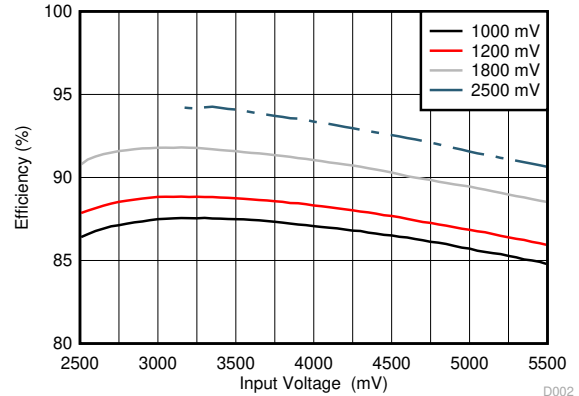

Load = 100 mA

V_{OUT} settings = 1000 mV, 1200 mV, 1800 mV, and 2500 mV

Figure 8-3. Efficiency vs Input Voltage in PFM Mode

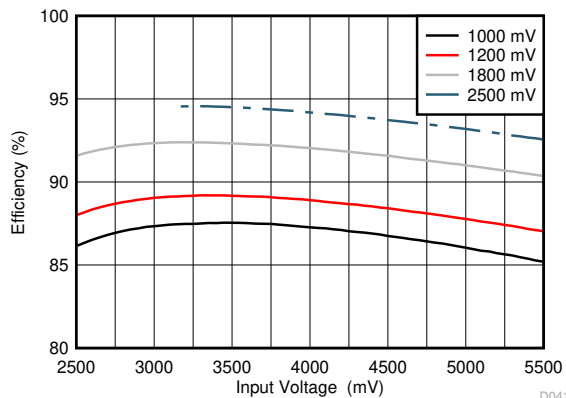

Load = 1A

V_{OUT} settings = 1000 mV, 1200 mV, 1800 mV, and 2500 mV

Figure 8-4. Efficiency vs Input Voltage in PWM Mode

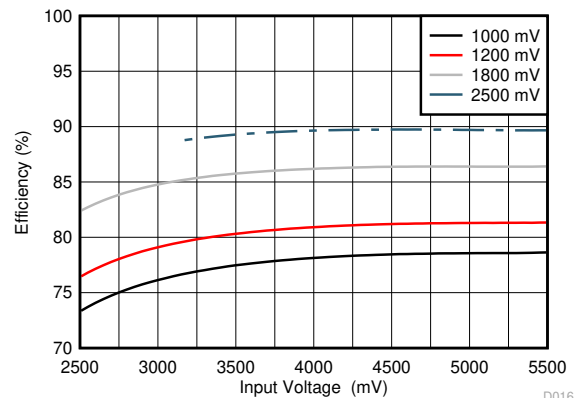

Load = 3A

V_{OUT} settings = 1000 mV, 1200 mV, 1800 mV, and 2500 mV

Figure 8-5. Efficiency vs Input Voltage in PWM Mode

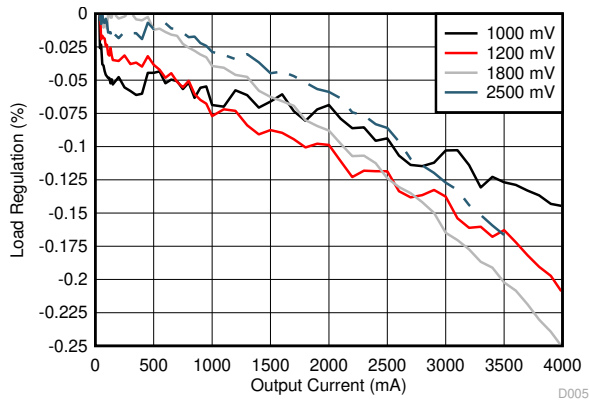

Change in Output Voltage from Zero Load (%)
 V_{OUT} settings = 1000 mV, 1200 mV, 1800 mV, and 2500 mV

Figure 8-6. DC Load Regulation in PWM mode

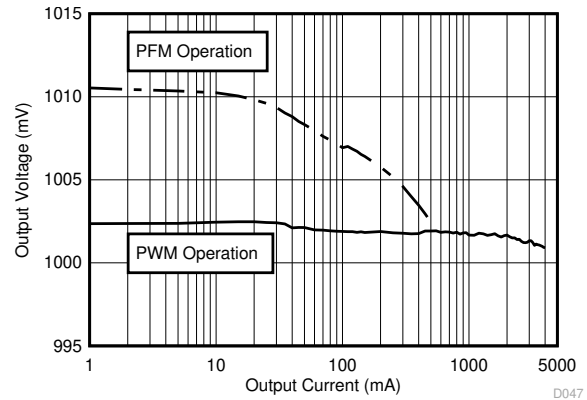

V_{OUT} setting = 1000 mV

Figure 8-7. Output Voltage vs Load Current in PWM-PFM Mode

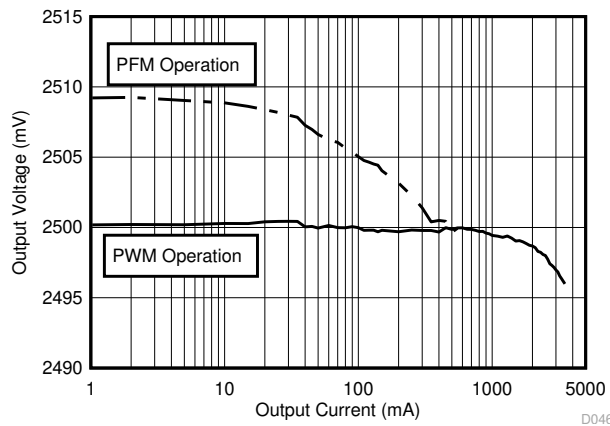

V_{OUT} setting = 2500 mV

Figure 8-8. Output Voltage vs Load Current in PWM-PFM Mode

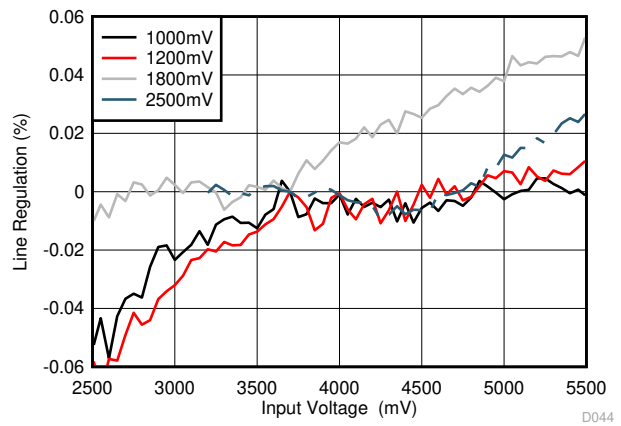

Change in Output Voltage from $V_{IN} = 3.7$ V (%) Load = 1 A
 V_{OUT} settings = 1000 mV, 1200 mV, 1800 mV, and 2500 mV

Figure 8-9. DC Line Regulation in PWM Mode

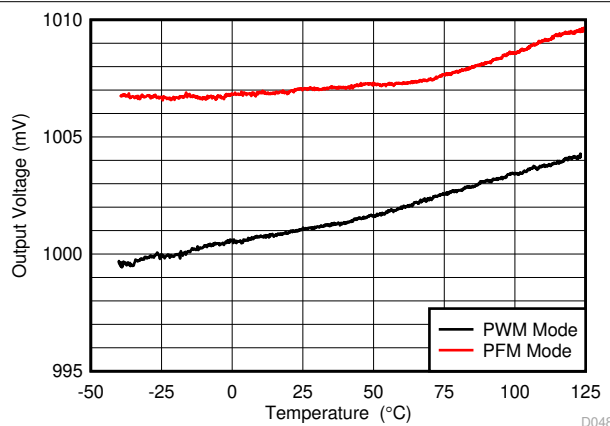

V_{OUT} setting = 1000 mV
Load = 1 A (PWM Mode) and 100 mA (PFM Mode)

Figure 8-10. Output Voltage vs Temperature

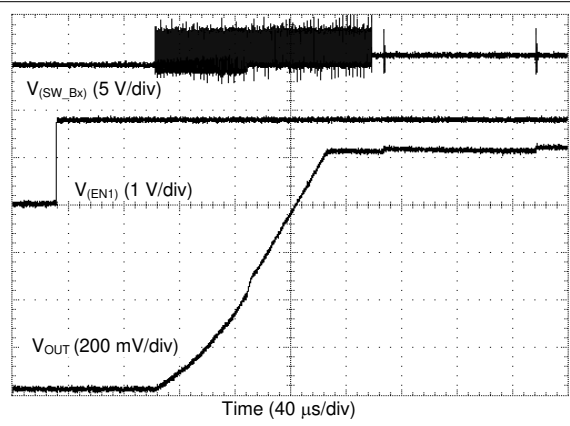

Load = 0 A

Figure 8-11. Start-up with EN1

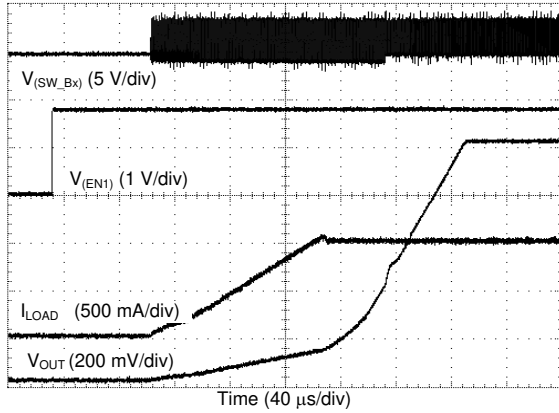

Load = 1 A

Figure 8-12. Start-up with EN1

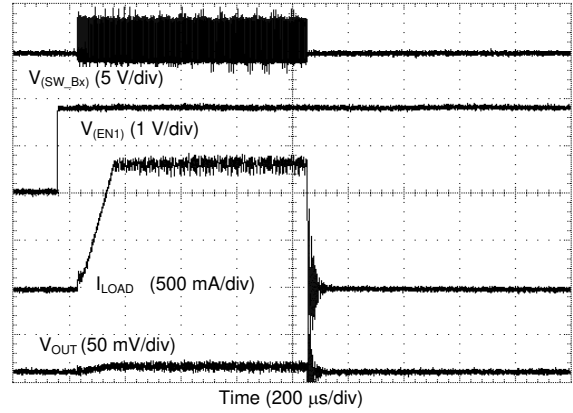
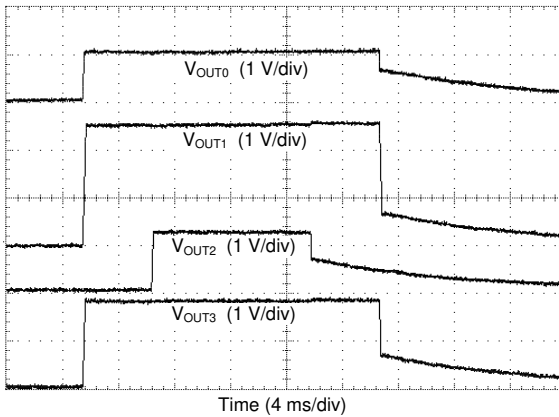
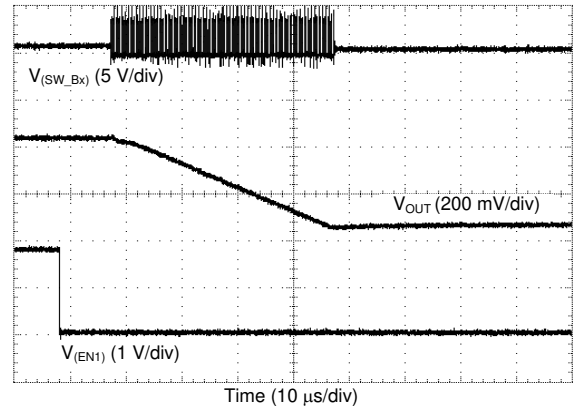

Figure 8-13. Start-up With Short on Output



Load = 0 A
Enable and disable delays = default
 V_{OUT} settings = default

Figure 8-14. $V_{OUT0,1,2,3}$: Start-up and Shutdown with Default Register Settings, triggered by EN1.



Load = 0 A

Figure 8-15. Shutdown with EN1

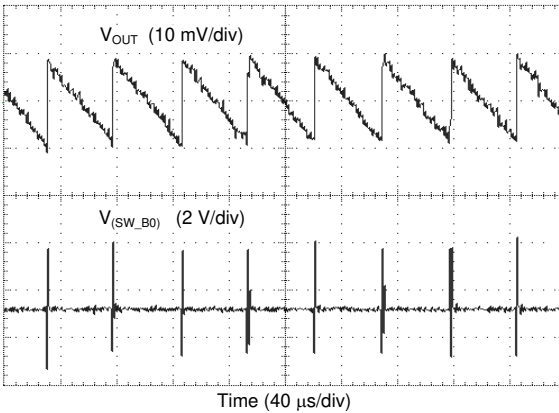

Load = 10 mA

Figure 8-16. Output Voltage Ripple, PFM Mode

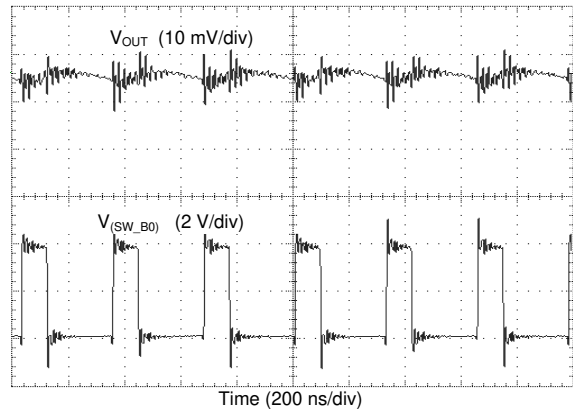

Load = 200 mA

Figure 8-17. Output Voltage Ripple, Forced PWM Mode

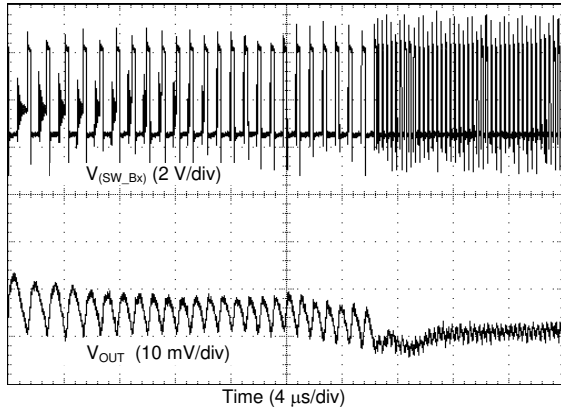

Figure 8-18. Transient from PFM-to-PWM Mode

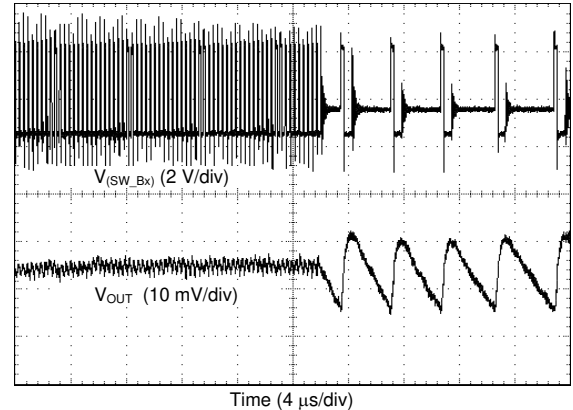
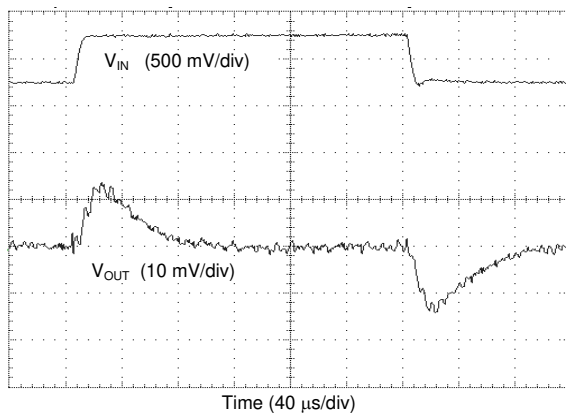
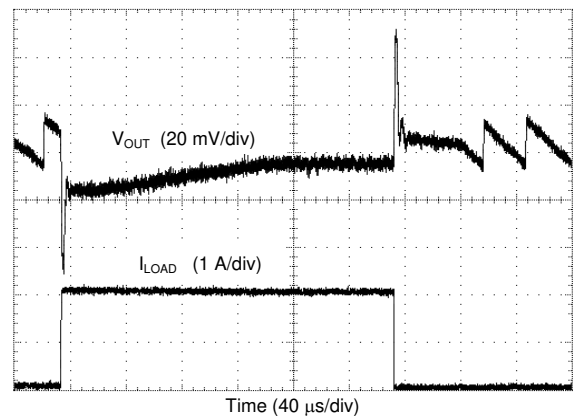

Figure 8-19. Transient from PWM-to-PFM Mode



Load = 4 A $V_{OUT} = 1000$ mV
 V_{IN} stepping 3.3 V \leftrightarrow 3.8 V, $T_R = T_F = 10$ μ s

Figure 8-20. Transient Line Response



Load = 0 A \rightarrow 2 A \rightarrow 0 A $T_R = T_F = 400$ ns $V_{OUT} = 1$ V

Figure 8-21. Transient Load Step Response, AUTO Mode

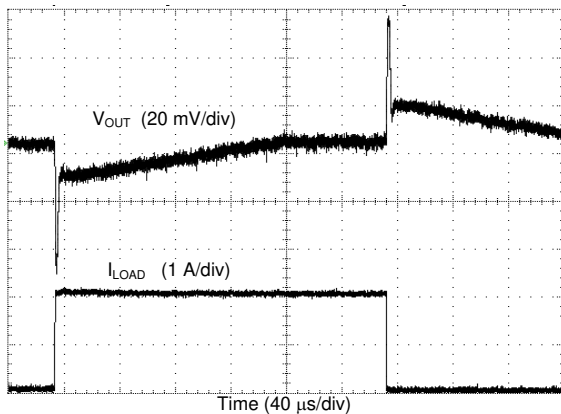

Load = 0 A \rightarrow 2 A \rightarrow 0 A $T_R = T_F = 400$ ns $V_{OUT} = 1$ V

Figure 8-22. Transient Load Step Response, Forced PWM Mode

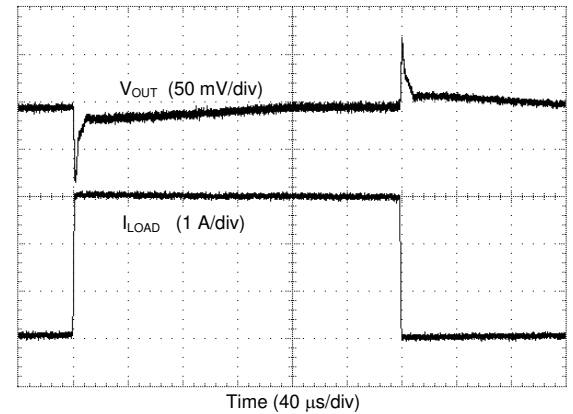

Load = 1 A \rightarrow 4 A \rightarrow 1 A $T_R = T_F = 1$ μ s $V_{OUT} = 1$ V

Figure 8-23. Transient Load Step Response, Forced PWM Mode

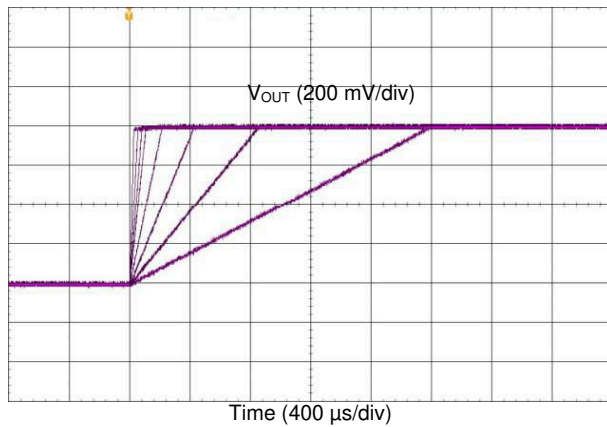

Figure 8-24. V_{OUT} Transition From 0.6 V to 1.4 V With Different Slew Rate Settings

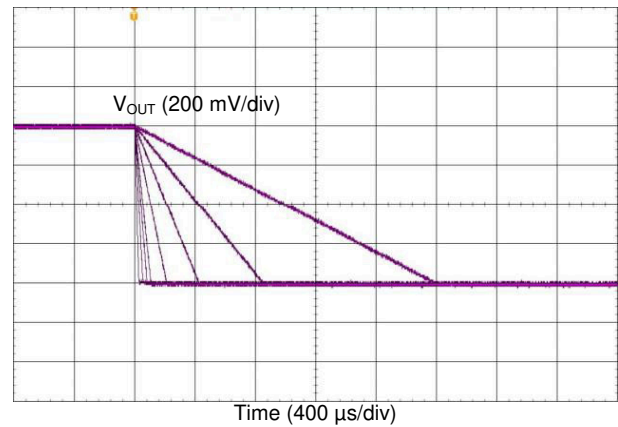

Figure 8-25. V_{OUT} Transition From 1.4 V to 0.6 V With Different Slew Rate Settings

9 Power Supply Recommendations

The device is designed to operate from an input voltage supply range between 2.5 V and 5.5 V. This input supply must be well-regulated and able to withstand maximum input current and maintain stable voltage without voltage drop even at load transition condition. The resistance of the input supply rail must be low enough that the input current transient does not cause too high drop in the LP8758-EA supply voltage that can cause false UVLO fault triggering. If the input supply is located more than a few inches from the LP8758-EA additional bulk capacitance may be required in addition to the ceramic bypass capacitors.

10 Layout

10.1 Layout Guidelines

The high frequency and large switching currents of the LP8758-EA make the choice of layout important. Good power supply results only occur when care is given to proper design and layout. Layout affects noise pickup and generation and can cause a good design to perform with less-than-expected results. With a range of output currents from milliamps to 4 A per converter core, good power supply layout is much more difficult than most general PCB design. The following steps should be used as a reference to ensure the device is stable and maintains proper voltage and current regulation across its intended operating voltage and current range.

1. Place C_{IN} as close as possible to the VIN_Bx pin and the PGND_Bxx pin. Route the V_{IN} trace wide and thick to avoid IR drops. The trace between the positive node of the input capacitor and the LP8758-EA VIN_Bx pin(s), as well as the trace between the input capacitor's negative node and power PGND_Bxx pin(s), must be kept as short as possible. The input capacitance provides a low-impedance voltage source for the switching converter. The inductance of the connection is the most important parameter of a local decoupling capacitor — parasitic inductance on these traces must be kept as tiny as possible for proper device operation.
2. The output filter, consisting of L_x and C_{OUTx} , converts the switching signal at SW_Bx to the noiseless output voltage. It must be placed as close as possible to the device keeping the switch node small, for best EMI behavior. Route the traces between the output capacitors of the device and the load (or input capacitors of the load) direct and wide to avoid losses due to the IR drop.
3. Input for analog blocks (VANA and AGND) must be isolated from noisy signals. Connect VANA directly to a quiet system voltage node and AGND to a quiet ground point where no IR drop occurs. Place the decoupling capacitor as close to the VANA pin as possible. VANA must be connected to the same power node as VIN_Bx pins.
4. If the load supports remote voltage sensing, connect the feedback pins FB_Bx of the device to the respective sense pins on the load. The sense lines are susceptible to noise. They must be kept away from noisy signals such as PGND_Bxx, VIN_Bx, and SW_Bx, as well as high bandwidth signals such as the I²C. Avoid both capacitive as well as inductive coupling by keeping the sense lines short and direct. Run the lines in a quiet layer. Isolate them from noisy signals by a voltage or ground plane if possible.
5. PGND_Bxx, VIN_Bx and SW_Bx must be routed on thick layers. They must not surround inner signal layers which are not able to withstand interference from noisy PGND_Bxx, VIN_Bx and SW_Bx.

Due to the small package of this converter and the overall small solution size, the thermal performance of the PCB layout is important. Many system-dependent issues such as thermal coupling, airflow, added heat sinks and convection surfaces, and the presence of other heat-generating components affect the power dissipation limits of a given component. Proper PCB layout, focusing on thermal performance, results in lower die temperatures. Wide power traces come with the ability to sink dissipated heat. This can be improved further on multi-layer PCB designs with vias to different planes. This results in reduced junction-to-ambient ($R_{\theta JA}$) and junction-to-board ($R_{\theta JB}$) thermal resistances and thereby reduces the device junction temperature, T_J . Performing a careful system-level 2D or full 3D dynamic thermal analysis at the beginning product design process is strongly recommended, using a thermal modeling analysis software.

10.2 Layout Example

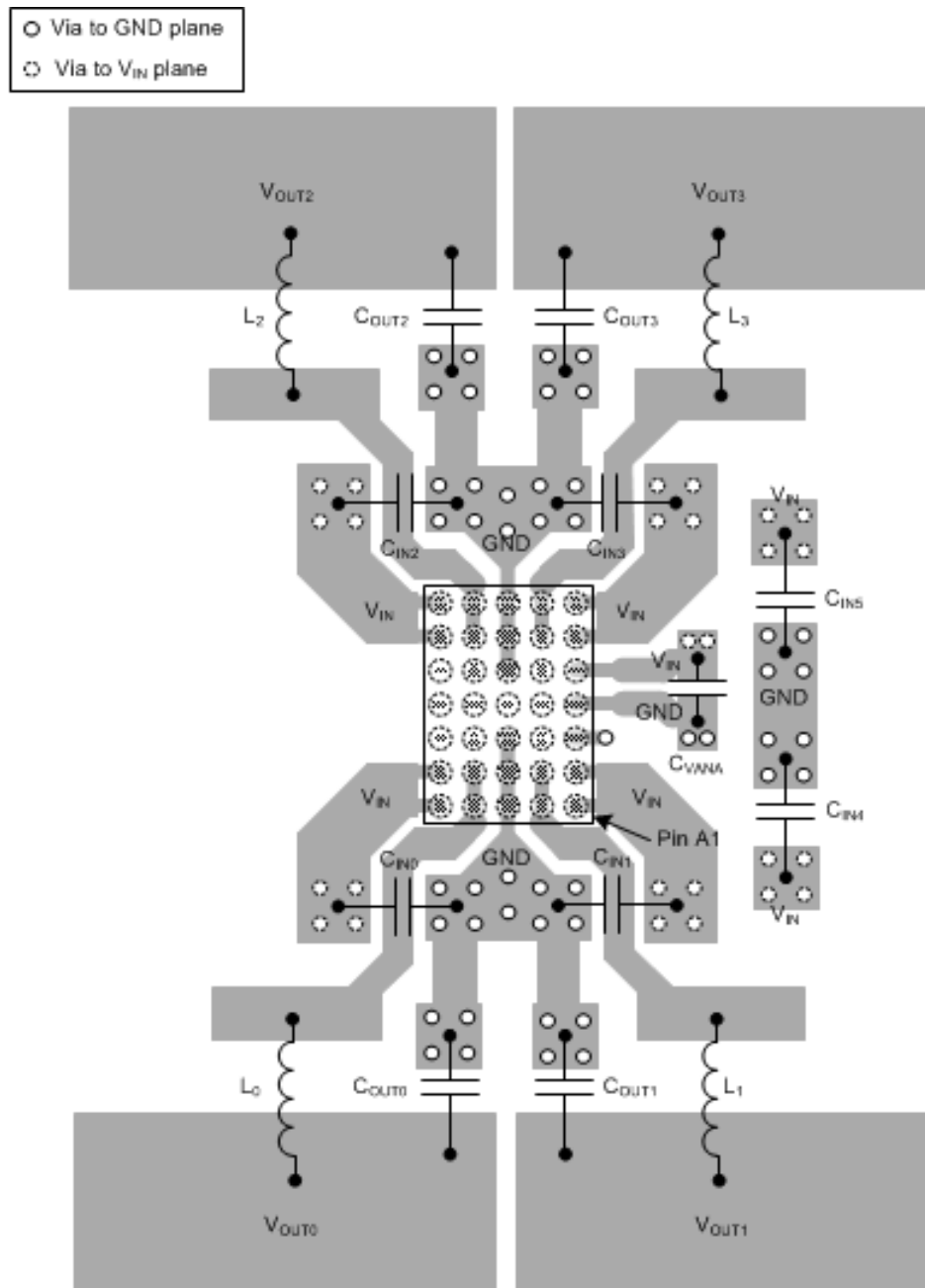

Figure 10-1. LP8758-EA Board Layout

11 Device and Documentation Support

11.1 Device Support

11.2 Documentation Support

11.2.1 Related Documentation

For related documentation, see the following:

- Texas Instruments, [DSBGA Wafer Level Chip Scale Package application report](#)
- Texas instruments, [Using the LP8758EVM Evaluation Module user's guide](#)

11.3 Receiving Notification of Documentation Updates

To receive notification of documentation updates, navigate to the device product folder on [ti.com](#). Click on *Subscribe to updates* to register and receive a weekly digest of any product information that has changed. For change details, review the revision history included in any revised document.

11.4 Support Resources

[TI E2E™ support forums](#) are an engineer's go-to source for fast, verified answers and design help — straight from the experts. Search existing answers or ask your own question to get the quick design help you need.

Linked content is provided "AS IS" by the respective contributors. They do not constitute TI specifications and do not necessarily reflect TI's views; see TI's [Terms of Use](#).

11.5 Trademarks

TI E2E™ is a trademark of Texas Instruments.

All trademarks are the property of their respective owners.

11.6 Electrostatic Discharge Caution



This integrated circuit can be damaged by ESD. Texas Instruments recommends that all integrated circuits be handled with appropriate precautions. Failure to observe proper handling and installation procedures can cause damage.

ESD damage can range from subtle performance degradation to complete device failure. Precision integrated circuits may be more susceptible to damage because very small parametric changes could cause the device not to meet its published specifications.

11.7 Glossary

[TI Glossary](#) This glossary lists and explains terms, acronyms, and definitions.

12 Mechanical, Packaging, and Orderable Information

The following pages include mechanical, packaging, and orderable information. This information is the most current data available for the designated devices. This data is subject to change without notice and revision of this document. For browser-based versions of this data sheet, refer to the left-hand navigation.

PACKAGING INFORMATION

Orderable Device	Status (1)	Package Type	Package Drawing	Pins	Package Qty	Eco Plan (2)	Lead finish/ Ball material (6)	MSL Peak Temp (3)	Op Temp (°C)	Device Marking (4/5)	Samples
LP8758A2EAYFFR	ACTIVE	DSBGA	YFF	35	3000	RoHS & Green	SAC396	Level-1-260C-UNLIM	-40 to 105	LP8758A2EA	Samples

(1) The marketing status values are defined as follows:

ACTIVE: Product device recommended for new designs.

LIFEBUY: TI has announced that the device will be discontinued, and a lifetime-buy period is in effect.

NRND: Not recommended for new designs. Device is in production to support existing customers, but TI does not recommend using this part in a new design.

PREVIEW: Device has been announced but is not in production. Samples may or may not be available.

OBSOLETE: TI has discontinued the production of the device.

(2) **RoHS:** TI defines "RoHS" to mean semiconductor products that are compliant with the current EU RoHS requirements for all 10 RoHS substances, including the requirement that RoHS substance do not exceed 0.1% by weight in homogeneous materials. Where designed to be soldered at high temperatures, "RoHS" products are suitable for use in specified lead-free processes. TI may reference these types of products as "Pb-Free".

RoHS Exempt: TI defines "RoHS Exempt" to mean products that contain lead but are compliant with EU RoHS pursuant to a specific EU RoHS exemption.

Green: TI defines "Green" to mean the content of Chlorine (Cl) and Bromine (Br) based flame retardants meet JS709B low halogen requirements of <=1000ppm threshold. Antimony trioxide based flame retardants must also meet the <=1000ppm threshold requirement.

(3) MSL, Peak Temp. - The Moisture Sensitivity Level rating according to the JEDEC industry standard classifications, and peak solder temperature.

(4) There may be additional marking, which relates to the logo, the lot trace code information, or the environmental category on the device.

(5) Multiple Device Markings will be inside parentheses. Only one Device Marking contained in parentheses and separated by a "-" will appear on a device. If a line is indented then it is a continuation of the previous line and the two combined represent the entire Device Marking for that device.

(6) Lead finish/Ball material - Orderable Devices may have multiple material finish options. Finish options are separated by a vertical ruled line. Lead finish/Ball material values may wrap to two lines if the finish value exceeds the maximum column width.

Important Information and Disclaimer:The information provided on this page represents TI's knowledge and belief as of the date that it is provided. TI bases its knowledge and belief on information provided by third parties, and makes no representation or warranty as to the accuracy of such information. Efforts are underway to better integrate information from third parties. TI has taken and continues to take reasonable steps to provide representative and accurate information but may not have conducted destructive testing or chemical analysis on incoming materials and chemicals. TI and TI suppliers consider certain information to be proprietary, and thus CAS numbers and other limited information may not be available for release.

In no event shall TI's liability arising out of such information exceed the total purchase price of the TI part(s) at issue in this document sold by TI to Customer on an annual basis.

TAPE AND REEL INFORMATION

QUADRANT ASSIGNMENTS FOR PIN 1 ORIENTATION IN TAPE

*All dimensions are nominal

Device	Package Type	Package Drawing	Pins	SPQ	Reel Diameter (mm)	Reel Width W1 (mm)	A0 (mm)	B0 (mm)	K0 (mm)	P1 (mm)	W (mm)	Pin1 Quadrant
LP8758A2EAYFFR	DSBGA	YFF	35	3000	180.0	8.4	2.28	3.03	0.74	4.0	8.0	Q1

TAPE AND REEL BOX DIMENSIONS

*All dimensions are nominal

Device	Package Type	Package Drawing	Pins	SPQ	Length (mm)	Width (mm)	Height (mm)
LP8758A2EAYFFR	DSBGA	YFF	35	3000	182.0	182.0	20.0

YFF (R-XBGA-N35)

DIE-SIZE BALL GRID ARRAY

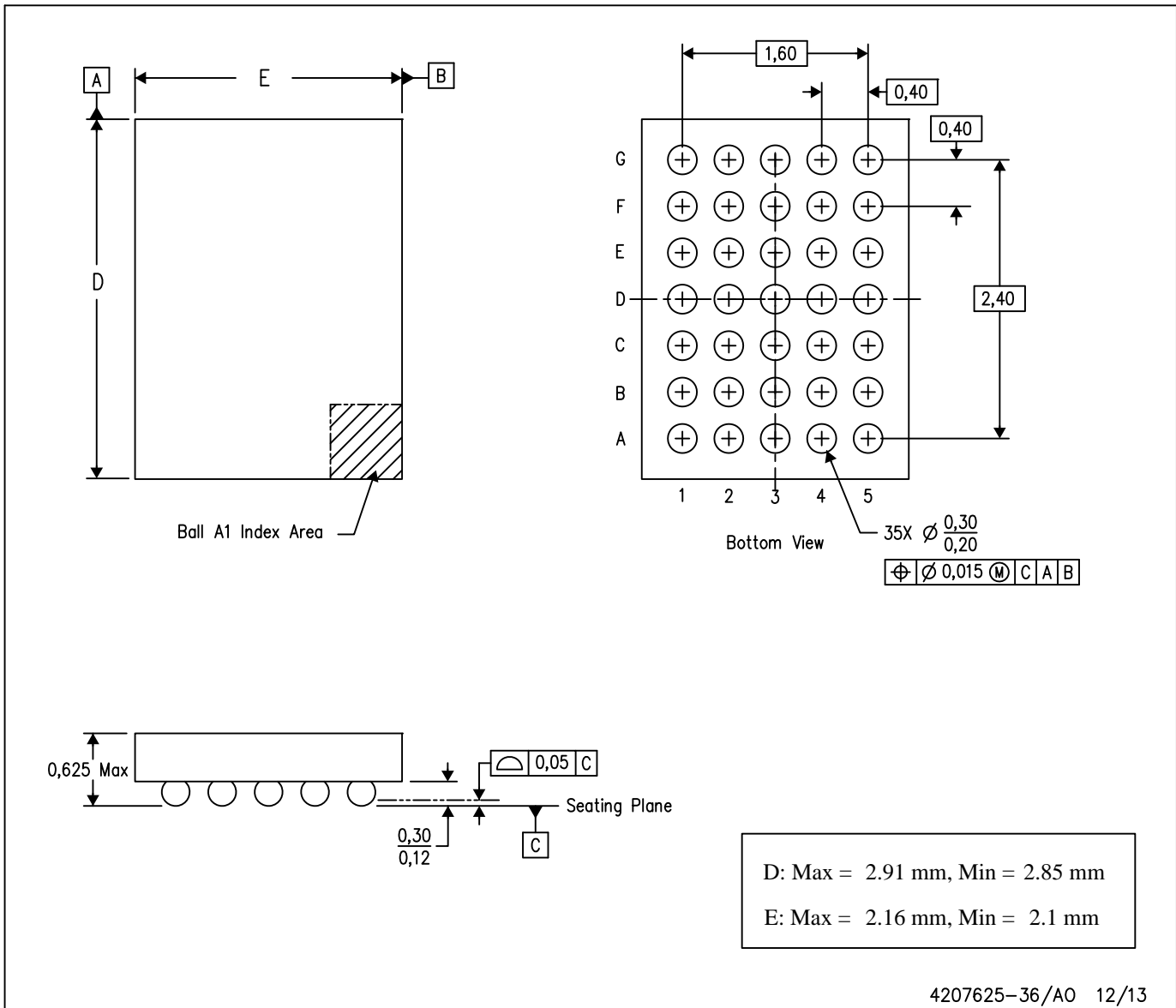

- NOTES: A. All linear dimensions are in millimeters. Dimensioning and tolerancing per ASME Y14.5M-1994.
 B. This drawing is subject to change without notice.
 C. NanoFree™ package configuration.

NanoFree is a trademark of Texas Instruments.

IMPORTANT NOTICE AND DISCLAIMER

TI PROVIDES TECHNICAL AND RELIABILITY DATA (INCLUDING DATA SHEETS), DESIGN RESOURCES (INCLUDING REFERENCE DESIGNS), APPLICATION OR OTHER DESIGN ADVICE, WEB TOOLS, SAFETY INFORMATION, AND OTHER RESOURCES "AS IS" AND WITH ALL FAULTS, AND DISCLAIMS ALL WARRANTIES, EXPRESS AND IMPLIED, INCLUDING WITHOUT LIMITATION ANY IMPLIED WARRANTIES OF MERCHANTABILITY, FITNESS FOR A PARTICULAR PURPOSE OR NON-INFRINGEMENT OF THIRD PARTY INTELLECTUAL PROPERTY RIGHTS.

These resources are intended for skilled developers designing with TI products. You are solely responsible for (1) selecting the appropriate TI products for your application, (2) designing, validating and testing your application, and (3) ensuring your application meets applicable standards, and any other safety, security, regulatory or other requirements.

These resources are subject to change without notice. TI grants you permission to use these resources only for development of an application that uses the TI products described in the resource. Other reproduction and display of these resources is prohibited. No license is granted to any other TI intellectual property right or to any third party intellectual property right. TI disclaims responsibility for, and you will fully indemnify TI and its representatives against, any claims, damages, costs, losses, and liabilities arising out of your use of these resources.

TI's products are provided subject to [TI's Terms of Sale](#) or other applicable terms available either on [ti.com](https://www.ti.com) or provided in conjunction with such TI products. TI's provision of these resources does not expand or otherwise alter TI's applicable warranties or warranty disclaimers for TI products.

TI objects to and rejects any additional or different terms you may have proposed.

Mailing Address: Texas Instruments, Post Office Box 655303, Dallas, Texas 75265
Copyright © 2023, Texas Instruments Incorporated