

FEATURES

- UL 60950 recognised
- Industry standard footprint
- Efficiency to 82%
- 1kVDC isolation 'Hi Pot Test'
- 2:1 wide input range
- Single isolated output
- Short circuit protection
- Low profile 24 pin case
- Operating temperature range -40°C to 85°C
- 5V, 12V, 24V & 48V inputs
- 5V, 9V, 12V & 15V outputs
- Internal SMD construction
- Fully encapsulated

DESCRIPTION

The NDY series is a range of low profile DC-DC converters offering a single regulated output over a 2:1 input voltage range. All parts deliver 3W output power up to 85°C without heatsinking, except the 4.5V to 9V input voltage range which should be derated to 2W at the lower input voltage. A flyback oscillator design with isolated feedback is used to give regulation over the full operating range of 25% to 100% of full load. It is strongly recommended that external capacitors be used on input and output to guarantee performance over full load and input voltage range.

SELECTION GUIDE

Order code	Input voltage V (Nom.)	Rated output voltage V	Output current		Input current full load mA	Efficiency ² (Min.) %	Isolation capacitance pF	MTTF ³ kHrs	Recommended Alternative
			Min. Load ¹ mA	Full load mA					
			Recommended		In Production				
NDY0512C	5	12	42-62	166-250	548	71	43	1907	
NDY1205C	12	5	150	600	362	71	36	1928	
NDY1209C	12	9	83	333	320	78	52	1916	
NDY1212C	12	12	62	250	316	78	44	1897	
NDY1215C	12	15	50	200	308	79	47	1914	
NDY2405C	24	5	150	600	174	70	36	1673	
NDY2412C	24	12	62	250	154	80	44	1644	
NDY2415C	24	15	50	200	150	82	54	1657	
NDY4805C	48	5	150	600	87	73	35	1668	
To be discontinued									
NDY0505C	5	5	100-150	400-600	615	66	40	1939	NDTS0505C
NDY0509C	5	9	55-83	222-333	563	72	52	1926	Contact Murata
NDY0515C	5	15	33-50	133-200	533	73	44	1924	Contact Murata
NDY2409C	24	9	83	333	156	78	52	1663	Contact Murata
Discontinued									
NDY2403C	24	3.3	227	909	178	70	30	1671	NCS3S4803SC
NDY4803C	48	3.3	227	909	87	71	30	1676	NCS3S4803SC
NDY4809C	48	9	83	333	78	80	52	1663	Contact Murata
NDY4812C	48	12	62	250	77	81	44	1648	NCS3S4812SC
NDY4815C	48	15	50	200	76	81	53	1661	NCS3S4815SC

INPUT CHARACTERISTICS

Parameter	Conditions	Min.	Typ.	Max.	Units
Voltage range	All NDY05XX	4.5	5	9	VDC
	All NDY12XX	9	12	18	
	All NDY24XX	18	24	36	
	All NDY48XX	36	48	72	
Reflected ripple current ²	NDY2403		180	360	mA p-p
	NDY4803		140	290	
	All NDY05XX		400	500	
	All NDY12XX		150	170	
	All other NDY24XX		290	360	
	All other NDY48XX		100	127	



For full details go to
<https://www.murata.com/en-global/products/power/rohs>



1. Refer to power derating graph.

2. Measured at full load with external input/output capacitors, refer to filter circuit 1.

3. Calculated using MIL-HDBK-217F with nominal input voltage at full load (ground benign) at 25°C.

All specifications typical at T_A=25°C, nominal input voltage and rated output current unless otherwise specified.

OUTPUT CHARACTERISTICS					
Parameter	Conditions	Min.	Typ.	Max.	Units
Voltage set point accuracy	With external input/output capacitors		±1	±5	%
Line regulation	Low line to high line, 3.3V output with external input/output capacitors		0.05	0.25	%
	Low line to high line, all other outputs with external input/output capacitors		0.05	0.5	%
Load regulation	25% load to 100% load, 3.3V output with external input/output capacitors		0.6	1.0	%
	25% load to 100% load, all other outputs with external input/output capacitors		0.2	0.5	%
Ripple ¹	BW = 20Hz to 300kHz, 3.3V output with external input/output capacitors		80	120	mV rms
	BW = 20Hz to 300kHz, all other outputs with external input/output capacitors		5	10	
Noise ¹	BW = DC to 100MHz, 3.3V output with external input/output capacitors			180	mV p-p
	BW = DC to 20MHz, all other outputs with external input/output capacitors		50	100	

ISOLATION CHARACTERISTICS					
Parameter	Conditions	Min.	Typ.	Max.	Units
Isolation test voltage	Flash tested for 1 second	1000			VDC
Resistance	Viso=500VDC	1			GΩ

GENERAL CHARACTERISTICS					
Parameter	Conditions	Min.	Typ.	Max.	Units
Switching frequency	100% load V_{IN} nominal 3.3V output	160		220	kHz
	25% load V_{IN} nominal 3.3V output	290		560	
	100% load V_{IN} nominal, all other outputs	80		220	
	25% load V_{IN} nominal, all other outputs	290		560	

TEMPERATURE CHARACTERISTICS					
Parameter	Conditions	Min.	Typ.	Max.	Units
Operation	Ambient temperature	-40		85	°C
Storage		-50		130	
Cooling	Free air convection				

ABSOLUTE MAXIMUM RATINGS	
Short-circuit protection	Continuous
Lead temperature 1.5mm from case for 10 seconds	260°C
Minimum load	25% of rated load
Wave Solder	Wave Solder profile not to exceed the profile recommended in IEC 61760-1 Section 6.1.3. Please refer to application notes for further information.
Input voltage 05 types	10V
Input voltage 12 types	20V
Input voltage 24 types	40V
Input voltage 48 types	80V
Internal dissipation	1.7W

1. For lower ripple refer to circuit for reduced ripple.

TECHNICAL NOTES

ISOLATION VOLTAGE

'Hi Pot Test', 'Flash Tested', 'Withstand Voltage', 'Proof Voltage', 'Dielectric Withstand Voltage' & 'Isolation Test Voltage' are all terms that relate to the same thing, a test voltage, applied for a specified time, across a component designed to provide electrical isolation, to verify the integrity of that isolation.

Murata Power Solutions NDY series of DC-DC converters are all 100% production tested at their stated isolation voltage. This is 1kVDC for 1 second.

A question commonly asked is, "What is the continuous voltage that can be applied across the part in normal operation?"

The NDY series has been recognised by Underwriters Laboratory for functional isolation. Both input and output should normally be maintained within SELV limits i.e. less than 42.4V peak, or 60VDC. The isolation test voltage represents a measure of immunity to transient voltages and the part should never be used as an element of a safety isolation system.

The part could be expected to function correctly with several hundred volts offset applied continuously across the isolation barrier; but then the circuitry on both sides of the barrier must be regarded as operating at an unsafe voltage and further isolation/insulation systems must form a barrier between these circuits and any user-accessible circuitry according to safety standard requirements.

REPEATED HIGH-VOLTAGE ISOLATION TESTING

It is well known that repeated high-voltage isolation testing of a barrier component can actually degrade isolation capability, to a lesser or greater degree depending on materials, construction and environment. The NDY series has an EI ferrite core, with no additional insulation between primary and secondary windings of enamelled wire. While parts can be expected to withstand several times the stated test voltage, the isolation capability does depend on the wire insulation. Any material, including this enamel (typically polyurethane) is susceptible to eventual chemical degradation when subject to very high applied voltages thus implying that the number of tests should be strictly limited. We therefore strongly advise against repeated high voltage isolation testing, but if it is absolutely required, that the voltage be reduced by 20% from specified test voltage.

This consideration equally applies to agency recognised parts rated for better than functional isolation where the wire enamel insulation is always supplemented by a further insulation system of physical spacing or barriers.

SAFETY APPROVAL

The NDY series has been recognised by Underwriters Laboratory (UL) to UL 60950 for functional insulation for a maximum case temperature limit of 130°C (case temperature measured on the face opposite the pins). File number E151252 applies.

Note: This series gained UL 60950 recognition for products manufactured on or after date code G1123, any NDY parts manufactured before this date code should not be considered UL 60950 recognised. Any NDY that is UL recognised will be printed with the UL logo.



RoHS COMPLIANCE INFORMATION



This series is compatible with RoHS soldering systems with a peak wave solder temperature of 260°C for 10 seconds. Please refer to [application notes](#) for further information. The pin termination finish on this product series is Bright Tin. The series is backward compatible with Sn/Pb soldering systems.

For further information, please visit www.murata-ps.com/rohs

PART NUMBER STRUCTURE

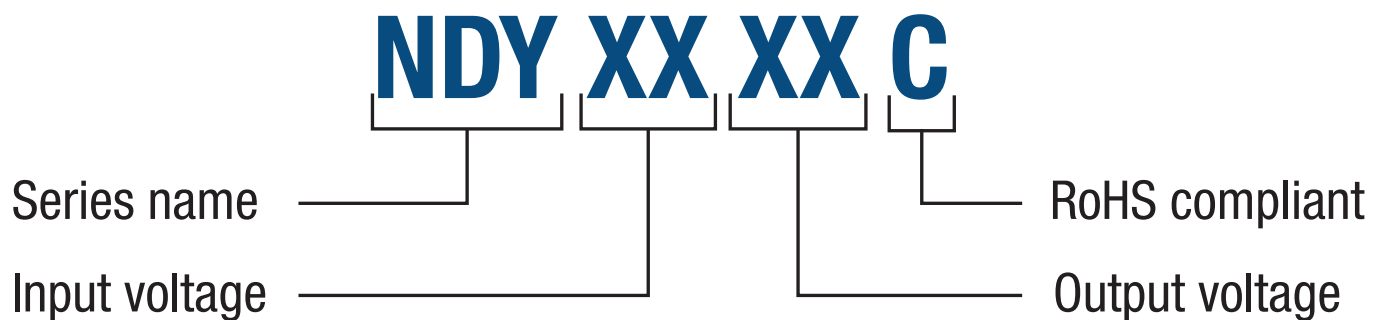

APPLICATION NOTES

Recommended input & output capacitors

Although these converters will work without external capacitors, they are necessary in order to guarantee the full parametric performance over the full line and load range. All parts have been tested and characterised using the following values and test circuit.

Input Voltage	C _{IN}	Output Voltage	C _{OUT}	L _{OUT}
5V, 12V	100µF, 25V (0.25Ω at 100KHz)	3.3V	100µF, 25V (0.25Ω at 100KHz)	MPS# - 24100C
24V, 48V	10µF, 100V (1.5Ω at 100KHz)	5V, 12V, 15V		Not required

Test circuit, 5V, 12V and 15V output

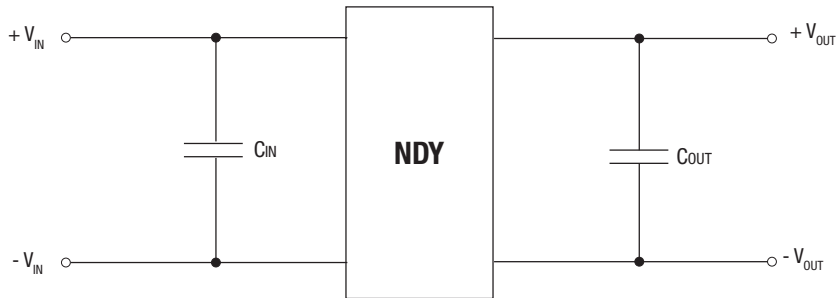

Recommended circuit for reduced ripple 3.3V output

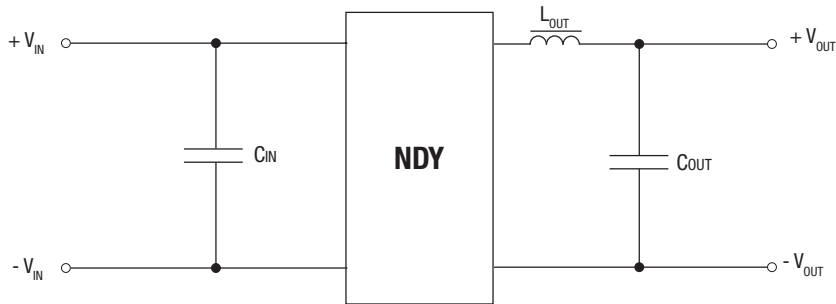

Output load

The minimum rated load across the whole input voltage range is 25% of the full load output. It is important to take care that the load does not fall below this as the output ripple will greatly increase. While this condition will not harm the device the resultant increase in output ripple could cause customer's application to malfunction.

NDY05 POWER DERATING CURVE

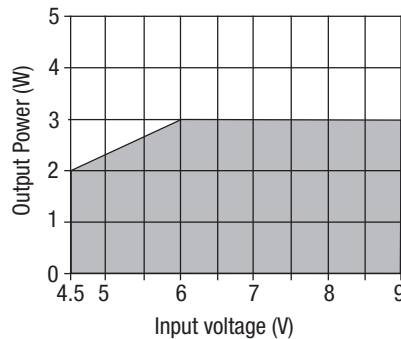

PACKAGE SPECIFICATIONS

MECHANICAL DIMENSIONS

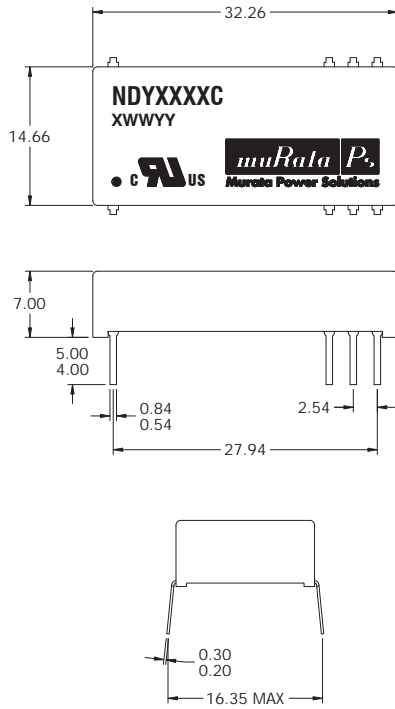

Weight: 6.2g (3.3V: 6.7g)

All dimensions in mm ± 0.25 mm. All pins on a 2.54 pitch and within ± 0.25 true position.

PIN CONNECTIONS (TOP VIEW)

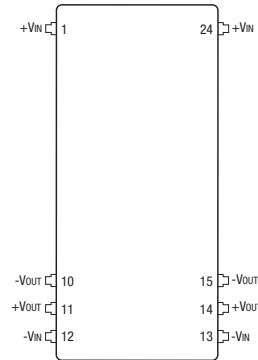

RECOMMENDED FOOTPRINT DETAILS

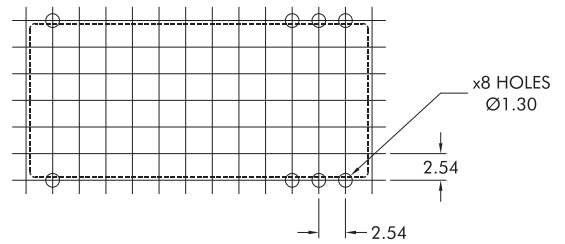

Unless otherwise stated all dimensions in mm ± 0.5 mm.

TUBE OUTLINE DIMENSIONS

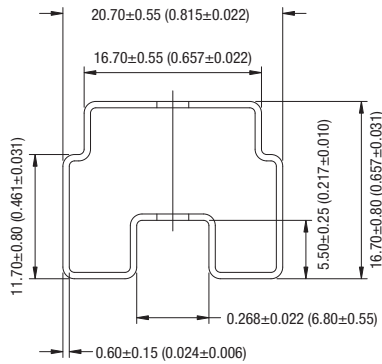

Unless otherwise stated all dimensions in mm ± 0.5 mm (inches ± 0.01).
Tube length : 520mm ± 2 mm (20.47 ± 0.079).

Tube Quantity : 15

DISCLAIMER

Unless otherwise stated in the datasheet, all products are designed for standard commercial and industrial applications and NOT for safety-critical and/or life-critical applications.

Particularly for safety-critical and/or life-critical applications, i.e. applications that may directly endanger or cause the loss of life, inflict bodily harm and/or loss or severe damage to equipment/property, and severely harm the environment, a prior explicit written approval from Murata is strictly required. Any use of Murata standard products for any safety-critical, life-critical or any related applications without any prior explicit written approval from Murata shall be deemed unauthorised use.

These applications include but are not limited to:

- Aircraft equipment
- Aerospace equipment
- Undersea equipment
- Power plant control equipment
- Medical equipment
- Transportation equipment (automobiles, trains, ships, etc.)
- Traffic signal equipment
- Disaster prevention / crime prevention equipment
- Data Processing equipment

Murata makes no express or implied warranty, representation, or guarantee of suitability, fitness for any particular use/purpose and/or compatibility with any application or device of the buyer, nor does Murata assume any liability whatsoever arising out of unauthorised use of any Murata product for the application of the buyer. The suitability, fitness for any particular use/purpose and/or compatibility of Murata product with any application or device of the buyer remain to be the responsibility and liability of the buyer.

Buyer represents and agrees that it has all the necessary expertise to create and implement safeguards that anticipate dangerous consequences of failures, monitor failures and their consequences, lessen the likelihood of failures that might cause harm, and take appropriate remedial actions. Buyer will fully indemnify and hold Murata, its affiliated companies, and its representatives harmless against any damages arising out of unauthorised use of any Murata products in any safety-critical and/or life-critical applications.

Remark: Murata in this section refers to Murata Manufacturing Company and its affiliated companies worldwide including, but not limited to, Murata Power Solutions.



This product is subject to the following [operating requirements](#) and the [Life and Safety Critical Application Sales Policy](#):

Refer to: <https://www.murata.com/en-eu/products/power/requirements>

Murata Power Solutions (Milton Keynes) Ltd. makes no representation that the use of its products in the circuits described herein, or the use of other technical information contained herein, will not infringe upon existing or future patent rights. The descriptions contained herein do not imply the granting of licenses to make, use, or sell equipment constructed in accordance therewith. Specifications are subject to change without notice.
© 2022 Murata Power Solutions (Milton Keynes) Ltd.