

## J176, J177 P-Channel JFET

### Features

- InterFET [P0099F Geometry](#)
- Low Noise: 8 nV/VHz Typical
- Low Rds(on): 150 Ohms Typical
- RoHS Compliant
- SMT, TH, and Bare Die Package options.

### Applications

- Choppers
- Commutators
- Analog Switches

### Description

The 30V InterFET J176 and J177 JFET's are targeted for high gain low noise switching, commutator, and chopper applications.

SOT23 Top View

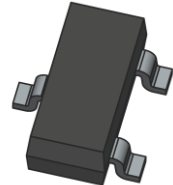
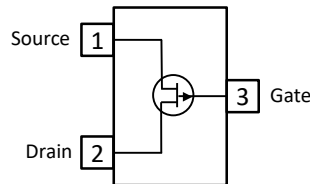

TO-92 Bottom View

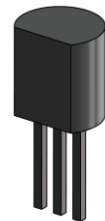
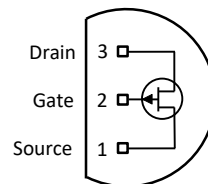

### Product Summary

Parameters	J176 Min	J177 Min	Unit
BV <sub>GSS</sub> Gate to Source Breakdown Voltage	30	30	V
I <sub>DSS</sub> Drain to Source Saturation Current	-2	-1.5	mA
V <sub>GS(off)</sub> Gate to Source Cutoff Voltage	1	0.8	V

### Ordering Information Custom Part and Binning Options Available

Part Number	Description	Case	Packaging
J176; J177	Through-Hole	TO-92	Bulk
SMPJ176; SMPJ177	Surface Mount	SOT23	Bulk
SMPJ176TR; SMPJ177TR	7" Tape and Reel: Max 3,000 Pieces 13" Tape and Reel: Max 9,000 Pieces	SOT23	Minimum 1,000 Pieces Tape and Reel
J176COT; J177COT	Chip Orientated Tray (COT Waffle Pack)	COT	400/Waffle Pack
J176CFT; J177CFT	Chip Face-up Tray (CFT Waffle Pack)	CFT	400/Waffle Pack



**Disclaimer:** It is the Buyers responsibility for designing, validating and testing the end application under all field use cases and extreme use conditions. Guaranteeing the application meets required standards, regulatory compliance, and all safety and security requirements is the responsibility of the Buyer. These resources are subject to change without notice.

## Electrical Characteristics

### Maximum Ratings (@ $T_A = 25^\circ\text{C}$ , Unless otherwise specified)

Parameters	Value	Unit
$V_{RGS}$ Reverse Gate Source and Gate Drain Voltage	30	V
$I_{FG}$ Continuous Forward Gate Current	50	mA
$P_D$ Continuous Device Power Dissipation	360	mW
$P$ Power Derating	3.27	mW/ $^\circ\text{C}$
$T_J$ Operating Junction Temperature	-55 to 125	$^\circ\text{C}$
$T_{STG}$ Storage Temperature	-65 to 200	$^\circ\text{C}$

### Static Characteristics (@ $T_A = 25^\circ\text{C}$ , Unless otherwise specified)

Parameters	Conditions	J176		J177		Unit
		Min	Max	Min	Max	
$V_{(BR)GSS}$ Gate to Source Breakdown Voltage	$V_{DS} = 0V, I_G = 1\mu\text{A}$	30		30		V
$I_{GSS}$ Gate to Source Reverse Current	$V_{GS} = 20V, V_{DS} = 0V$		1		1	nA
$V_{GS(OFF)}$ Gate to Source Cutoff Voltage	$V_{DS} = -15V, I_D = -10\text{nA}$	1	4	0.8	2.25	V
$I_{DSS}$ Drain to Source Saturation Current	$V_{GS} = 0V, V_{DS} = -15V$ (Pulsed)	-2	-35	-1.5	-20	mA
$I_{D(OFF)}$ Drain Cutoff Current	$V_{DS} = -15V, V_{GS} = 10V$		-1		-1	nA

### Dynamic Characteristics (@ $T_A = 25^\circ\text{C}$ , Unless otherwise specified)

Parameters	Conditions	J176		J177		Unit
		Min	Max	Min	Max	
$R_{DS(ON)}$ Drain to Source ON Resistance	$V_{DS} \leq 0.1V, V_{GS} = 0V, f = 1\text{kHz}$		250		300	$\Omega$
$C_{gd}$ Drain Gate Capacitance	$V_{DS} = 0V, V_{GS} = 10V, f = 1\text{MHz}$	5.5 (typ)		5.5 (typ)		pF
$C_{gs}$ Input Capacitance	$V_{DS} = 0V, V_{GS} = 10V, f = 1\text{MHz}$	5.5 (typ)		5.5 (typ)		pF
$C_{gd} + C_{gs}$ Drain + Source Gate Capacitance	$V_{DS} = V_{GS} = 0V, f = 1\text{MHz}$	32 (typ)		32 (typ)		pF
$t_{d(ON)}$ Turn ON Delay Time	$V_{DD} = -6V$ J176: $V_{GS(OFF)} = 6V, R_L = 5600\Omega$ J177: $V_{GS(OFF)} = 3V, R_L = 10000\Omega$	15 (typ)		20 (typ)		ns
$t_r$ Rise Time		20 (typ)		25 (typ)		ns
$t_{d(OFF)}$ Turn OFF Delay Time		15 (typ)		20 (typ)		ns
$t_f$ Fall Time		20 (typ)		25 (typ)		ns

## SOT23 (TO-236AB) Mechanical and Layout Data

### Package Outline Data



1. All linear dimensions are in millimeters.
2. Package weight approximately 0.12 grams
3. Molded plastic case UL 94V-0 rated
4. For Tape and Reel specifications refer to InterFET CTC-021 Tape and Reel Specification, Document number: IF39002
5. Bulk product is shipped in standard ESD shipping material
6. Refer to JEDEC standards for additional information.

### Suggested Pad Layout

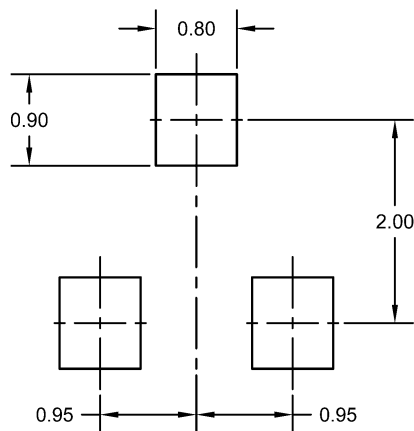

1. All linear dimensions are in millimeters.
2. The suggested land pattern dimensions have been provided for reference only. A more robust pattern may be desired for wave soldering.

## TO-92 Mechanical and Layout Data

### Package Outline Data

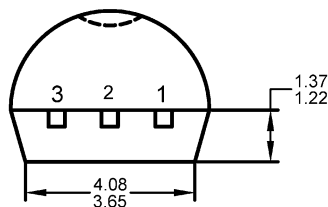
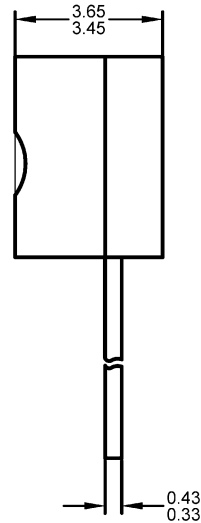
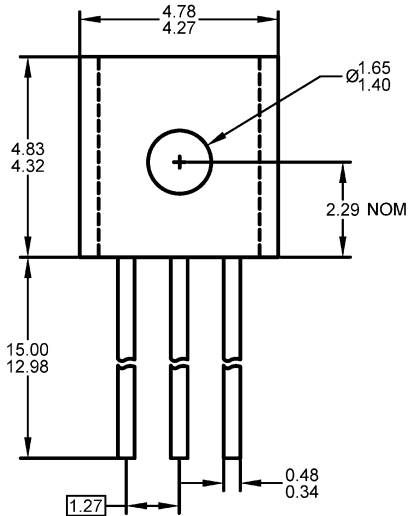

1. All linear dimensions are in millimeters.
2. Package weight approximately 0.19 grams
3. Molded plastic case UL 94V-0 rated
4. Bulk product is shipped in standard ESD shipping material
5. Refer to JEDEC standards for additional information.

### Suggested Through-Hole Layout

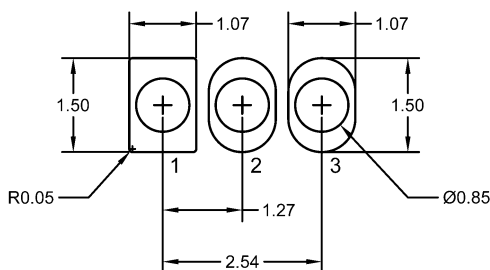

1. All linear dimensions are in millimeters.
2. The suggested land pattern dimensions have been provided as a straight lead reference only. A more robust pattern may be desired for wave soldering and/or bent lead configurations.