

Inductors for power circuits

Wound ferrite

VLS-AF series



VLS6045AF type



FEATURES

- Magnetic shield type wound inductor for power circuits.
- High magnetic shield construction achieved by a ferrite magnetic material and compatible with high-density mounting.
- Optimization of THD+N (Total Harmonic Distortion + Noise) characteristics based on VLS6045EX coils
- Operating temperature range: -40 to +105°C (Including self-temperature rise)

APPLICATION

- Class-D amplifier (AI speakers, Bluetooth speakers, TV speakers)

RELATED PRODUCT INFORMATION

- [Solution guide to the use of noise suppression filters in audio lines](#)

PART NUMBER CONSTRUCTION

VLS	6045	AF	-	3R3	N
Series name	LxWxH dimensions 6.0x6.0x4.5 mm	Internal code		Inductance (μH)	Inductance tolerance

CHARACTERISTICS SPECIFICATION TABLE

L (μH)	Measuring frequency		DC resistance	Rated current*		Part No.
	Tolerance	(kHz)	(Ω) \pm 30%	Isat (A)max.	Itemp (A)typ.	
3.3	\pm 30%	100	0.022	5.0	5.0	VLS6045AF-3R3N
4.7	\pm 20%	100	0.026	4.3	4.7	VLS6045AF-4R7M
6.8	\pm 20%	100	0.037	3.5	3.9	VLS6045AF-6R8M
8.2	\pm 20%	100	0.042	3.2	3.7	VLS6045AF-8R2M
10	\pm 20%	100	0.054	3.0	3.4	VLS6045AF-100M
15	\pm 20%	100	0.077	2.5	2.8	VLS6045AF-150M
22	\pm 20%	100	0.108	2.1	2.3	VLS6045AF-220M
33	\pm 20%	100	0.164	1.6	1.8	VLS6045AF-330M
100	\pm 20%	100	0.527	1.0	1.0	VLS6045AF-101M

* Rated current: smaller value of either Isat or Itemp.

Isat: When based on the inductance change rate (30% below the initial L value)

Itemp: When based on the temperature increase (temperature increase of 40°C by self heating)

Measurement equipment

Measurement item	Product No.	Manufacturer
L	4294A	Keysight Technologies, Inc. (formerly Hewlett-Packard)
DC resistance	34420A	Keysight Technologies, Inc. (formerly Hewlett-Packard)
Rated current Isat	4284A+42841A+42842A	Keysight Technologies, Inc. (formerly Hewlett-Packard)

* Equivalent measurement equipment may be used.



VLS6045AF type

TOTAL HARMONIC DISTORTION (TYPICAL CHARACTERISTICS)

□ THD+N measurement

THD+N v.s. Output power (f=1kHz, $R_L=8\Omega$)

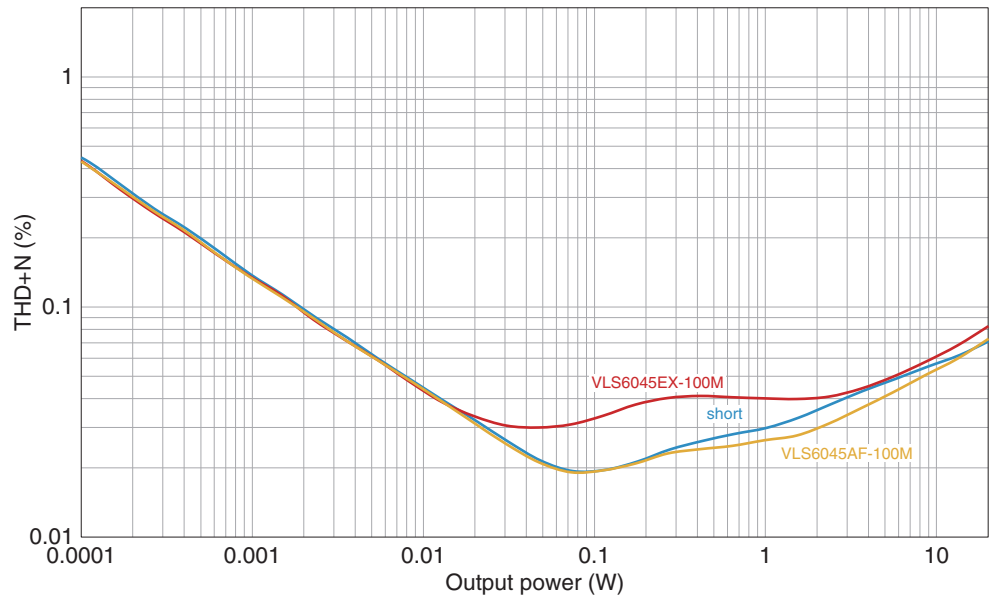
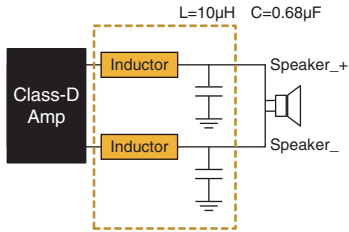

THD+N v.s. Output power (f=1kHz, $R_L=4\Omega$)

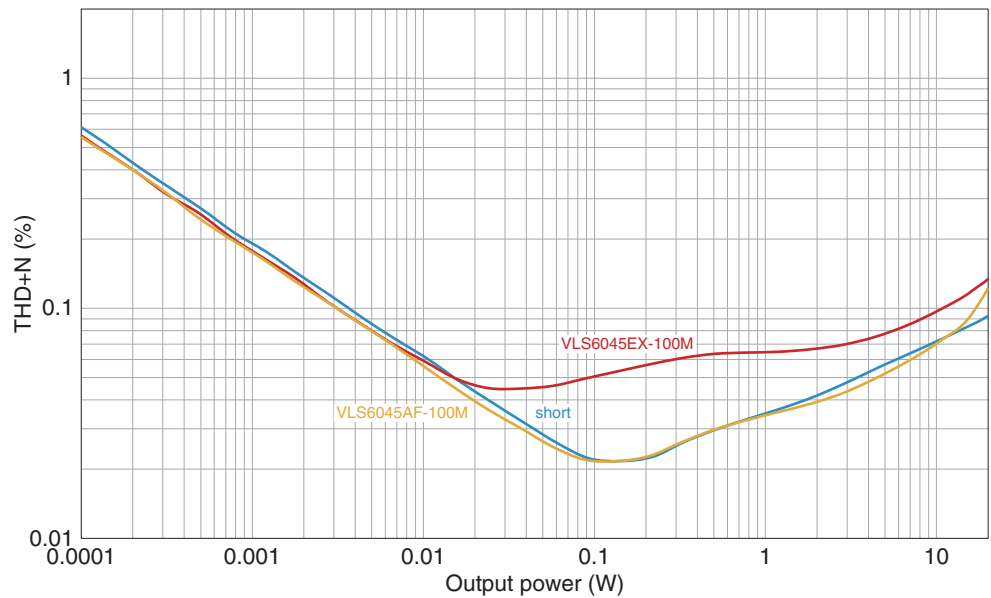
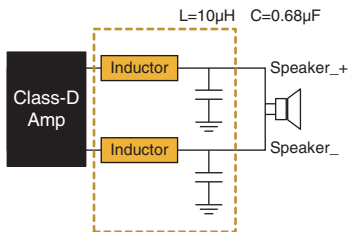

VLS6045AF type

L FREQUENCY CHARACTERISTICS

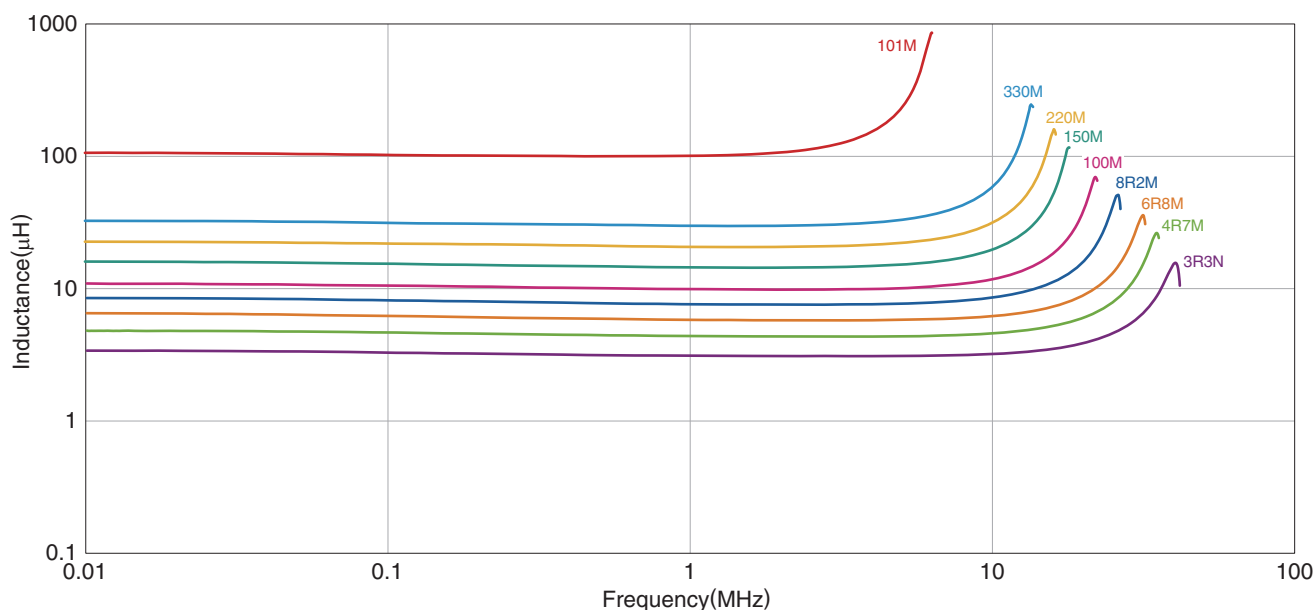

Measurement equipment

Product No.	Manufacturer
4294A	Keysight Technologies, Inc. (formerly Hewlett-Packard)

* Equivalent measurement equipment may be used.

INDUCTANCE VS. DC BIAS CHARACTERISTICS

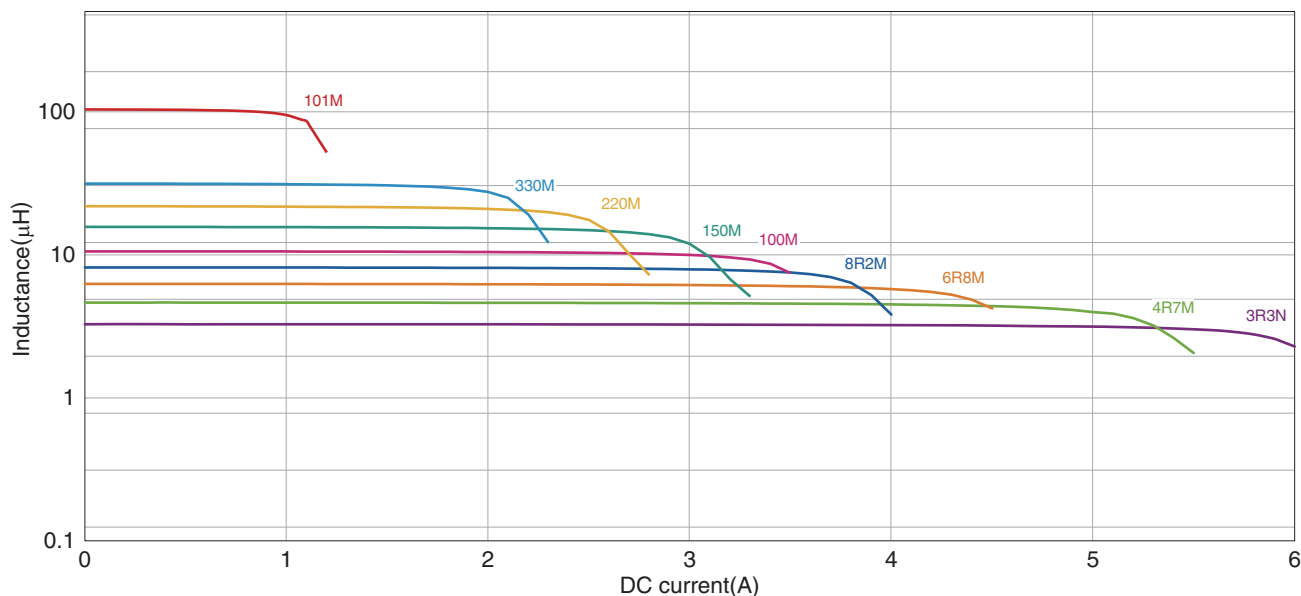

Measurement equipment

Product No.	Manufacturer
4284A+42841A+42842A	Keysight Technologies, Inc. (formerly Hewlett-Packard)

* Equivalent measurement equipment may be used.

VLS6045AF type

SHAPE & DIMENSIONS

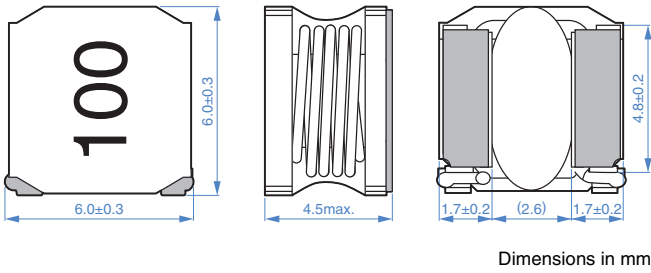

PACKAGING STYLE

REEL DIMENSIONS

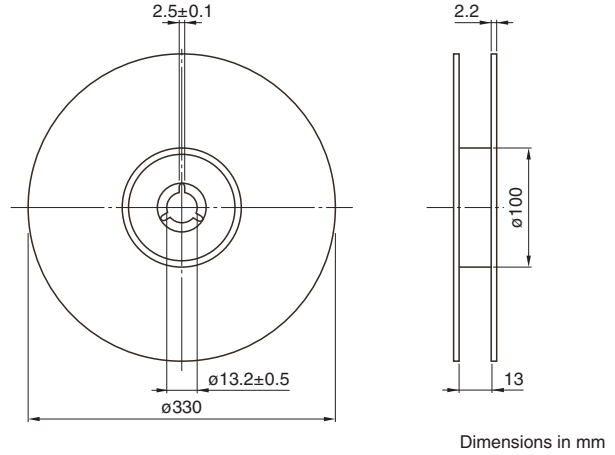

RECOMMENDED LAND PATTERN

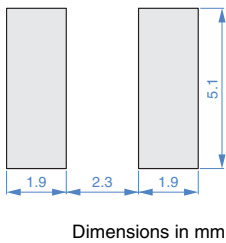

TAPE DIMENSIONS

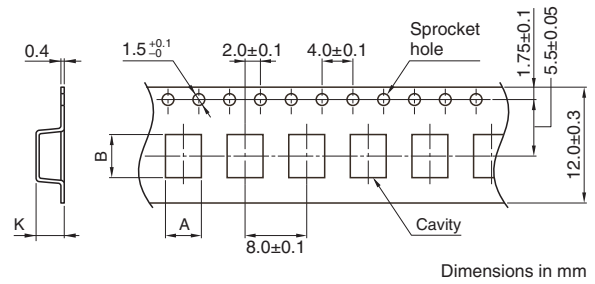

Type	A	B	K
VLS6045AF	6.3	6.3	4.7

RECOMMENDED REFLOW PROFILE

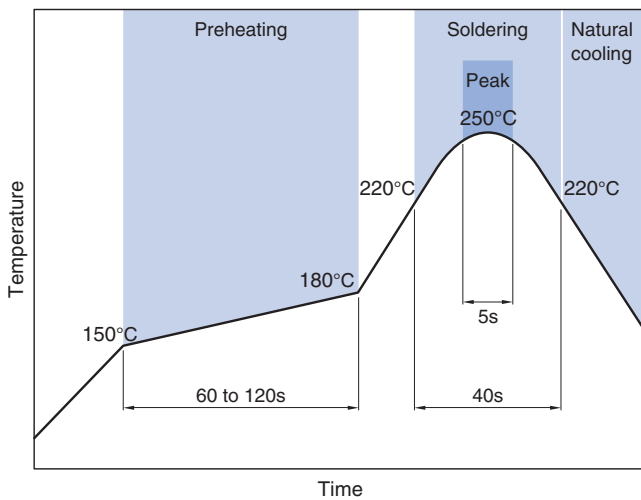

PACKAGE QUANTITY

Package quantity	1500 pcs/reel
------------------	---------------

TEMPERATURE RANGE, INDIVIDUAL WEIGHT

Operating temperature range*	Storage temperature range**	Individual weight
-40 to 105 °C	-40 to 105 °C	0.6 g

* Operating temperature range includes self-temperature rise.

** The storage temperature range is for after the assembly.

REMINDERS FOR USING THESE PRODUCTS

Before using these products, be sure to request the delivery specifications.

SAFETY REMINDERS

Please pay sufficient attention to the warnings for safe designing when using this products.

REMINDERS

- The storage period is less than 6 months. Be sure to follow the storage conditions (temperature: 5 to 30°C, humidity: 0 to 75% RH or less).
If the storage period elapses, the soldering of the terminal electrodes may deteriorate.
- Do not use or store in locations where there are conditions such as gas corrosion (salt, acid, alkali, etc.).
- Before soldering, be sure to preheat components.
The preheating temperature should be set so that the temperature difference between the solder temperature and chip temperature does not exceed 150°C.
- Soldering corrections after mounting should be within the range of the conditions determined in the specifications.
If overheated, a short circuit, performance deterioration, or lifespan shortening may occur.
- When embedding a printed circuit board where a chip is mounted to a set, be sure that residual stress is not given to the chip due to the overall distortion of the printed circuit board and partial distortion such as at screw tightening portions.
- Self heating (temperature increase) occurs when the power is turned ON, so the tolerance should be sufficient for the set thermal design.
- Carefully lay out the coil for the circuit board design of the non-magnetic shield type.
A malfunction may occur due to magnetic interference.
- Use a wrist band to discharge static electricity in your body through the grounding wire.
- Do not expose the products to magnets or magnetic fields.
- Do not use for a purpose outside of the contents regulated in the delivery specifications.
- The products listed on this catalog are intended for use in general electronic equipment (AV equipment, telecommunications equipment, home appliances, amusement equipment, computer equipment, personal equipment, office equipment, measurement equipment, industrial robots) under a normal operation and use condition.
The products are not designed or warranted to meet the requirements of the applications listed below, whose performance and/or quality require a more stringent level of safety or reliability, or whose failure, malfunction or trouble could cause serious damage to society, person or property.
If you intend to use the products in the applications listed below or if you have special requirements exceeding the range or conditions set forth in the each catalog, please contact us.

- (1) Aerospace/aviation equipment
- (2) Transportation equipment (cars, electric trains, ships, etc.)
- (3) Medical equipment
- (4) Power-generation control equipment
- (5) Atomic energy-related equipment
- (6) Seabed equipment
- (7) Transportation control equipment

- (8) Public information-processing equipment
- (9) Military equipment
- (10) Electric heating apparatus, burning equipment
- (11) Disaster prevention/crime prevention equipment
- (12) Safety equipment
- (13) Other applications that are not considered general-purpose applications

When designing your equipment even for general-purpose applications, you are kindly requested to take into consideration securing protection circuit/device or providing backup circuits in your equipment.