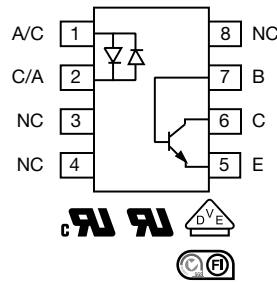
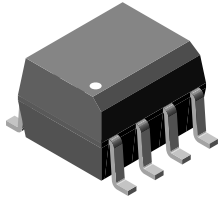


Optocoupler, Phototransistor Output, AC Input, With Base Connection


RoHS
COMPLIANT

FEATURES

- Guaranteed CTR symmetry, 2:1 maximum
- Bidirectional AC input industry standard SOIC-8 surface mountable package
- Isolation test voltage, 4000 V_{RMS}
- Standard lead
- spacing, 0.05"
- Available only on tape and reel (conform to EIA standard RS481A)
- Material categorization: for definitions of compliance please see www.vishay.com/doc?99912

LINKS TO ADDITIONAL RESOURCES



DESCRIPTION

The IL256AT is an AC input phototransistor optocoupler. The device consists of two infrared emitters connected in reverse parallel and coupled to a silicon NPN phototransistor detector.

These circuit elements are constructed with a standard SOIC-8 foot print.

The product is well suited for telecom applications such as ring detection or off / on hook status, given its bidirectional LED input and guaranteed current transfer ratio (CTR) minimum of 20 % at I_F = 10 mA.

APPLICATIONS

- Telecom applications ring detection

AGENCY APPROVALS

- [UL](#)
- [cUL](#)
- [DIN EN 60747-5-5 \(VDE 0884-5\)](#), available with option 1

ORDERING INFORMATION	
<div style="display: flex; justify-content: space-around; align-items: center;"> <div style="border: 1px solid black; padding: 2px 5px;">I</div> <div style="border: 1px solid black; padding: 2px 5px;">L</div> <div style="border: 1px solid black; padding: 2px 5px;">2</div> <div style="border: 1px solid black; padding: 2px 5px;">5</div> <div style="border: 1px solid black; padding: 2px 5px;">6</div> <div style="border: 1px solid black; padding: 2px 5px;">A</div> <div style="border: 1px solid black; padding: 2px 5px;">T</div> </div> <p style="text-align: center; margin-top: 5px;">PART NUMBER</p>	
AGENCY CERTIFIED / PACKAGE	CTR (%)
UL, cUL, VDE	≥ 20
SOIC-8, tape and reel	IL256AT

Note

- Additional options may be possible, please contact sales office



ABSOLUTE MAXIMUM RATINGS ($T_{amb} = 25\text{ }^{\circ}\text{C}$, unless otherwise specified)				
PARAMETER	CONDITION	SYMBOL	VALUE	UNIT
INPUT				
Forward continuous current		I_F	60	mA
Power dissipation		P_{diss}	90	mW
Derate linearly from 25 °C			0.8	mW/°C
OUTPUT				
Collector-emitter breakdown voltage		BV_{CEO}	30	V
Emitter-collector breakdown voltage		BV_{ECO}	5	V
Collector-base breakdown voltage		BV_{CBO}	70	V
Power dissipation		P_{diss}	150	mW
Derate linearly from 25 °C			2.0	mW/°C
COUPLER				
Isolation voltage, input to output		V_{ISO}	4000	V_{RMS}
Total package dissipation (LED and detector)		P_{tot}	240	mW
Derate linearly from 25 °C			3.2	mW/°C
Storage temperature		T_{stg}	-55 to +150	°C
Operating temperature		T_{amb}	-55 to +100	°C
Soldering time at 260 °C			10	s

Notes

- Stresses in excess of the absolute maximum ratings can cause permanent damage to the device. Functional operation of the device is not implied at these or any other conditions in excess of those given in the operational sections of this document. Exposure to absolute maximum ratings for extended periods of the time can adversely affect reliability.
- (1) Refer to reflow profile for soldering conditions for surface mounted devices

ELECTRICAL CHARACTERISTICS ($T_{amb} = 25\text{ }^{\circ}\text{C}$, unless otherwise specified)						
PARAMETER	TEST CONDITION	SYMBOL	MIN.	TYP.	MAX.	UNIT
INPUT						
Forward voltage	$I_F = 50\text{ mA}$	V_F	-	1.2	1.5	V
OUTPUT						
Collector emitter breakdown voltage	$I_C = 1.0\text{ mA}$	BV_{CEO}	30	50	-	V
Emitter collector breakdown voltage	$I_E = 100\text{ }\mu\text{A}$	BV_{ECO}	5	10	-	V
Collector base breakdown voltage	$I_C = 100\text{ }\mu\text{A}$	BV_{CBO}	70	90	-	V
Collector emitter leakage current	$V_{CE} = 10\text{ V}$	I_{CEO}	-	5	50	nA
COUPLER						
Saturation voltage, collector emitter	$I_F = 16\text{ mA}, I_C = 2\text{ mA}$	V_{CEsat}	-	-	0.4	V

Note

- Minimum and maximum values are testing requirements. Typical values are characteristics of the device and are the result of engineering evaluation. Typical values are for information only and are not part of the testing requirements.

CURRENT TRANSFER RATIO ($T_{amb} = 25\text{ }^{\circ}\text{C}$, unless otherwise specified)						
PARAMETER	TEST CONDITION	SYMBOL	MIN.	TYP.	MAX.	UNIT
I_C/I_F	$I_F = 10\text{ mA}, V_{CE} = 5\text{ V}$	CTR	20	-	-	%
Symmetry (CTR at +10 mA)/(CTR at -10 mA)			0.5	1	2	

SAFETY AND INSULATION RATINGS						
PARAMETER	TEST CONDITION	SYMBOL	MIN.	TYP.	MAX.	UNIT
Climatic classification	According to IEC 68 part 1		-	55 / 100 / 21	-	
Comparative tracking index		CTI	175	-	399	
V_{IOTM}			6000	-	-	V
V_{IORM}			560	-	-	V
P_{SO}			-	-	350	mW
I_{SI}			-	-	150	mA
T_{SI}			-	-	165	°C
Creepage distance			4	-	-	mm
Clearance distance			4	-	-	mm
Insulation thickness			0.2	-	-	mm

Note

- As per IEC 60747-5-5, §7.4.3.8.2, this optocoupler is suitable for “safe electrical insulation” only within the safety ratings. Compliance with the safety ratings shall be ensured by means of protective circuits.

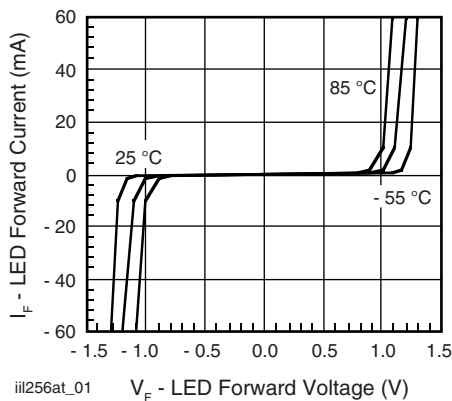
TYPICAL CHARACTERISTICS ($T_{amb} = 25\text{ °C}$, unless otherwise specified)


Fig. 1 - LED Forward Current vs. Forward Voltage

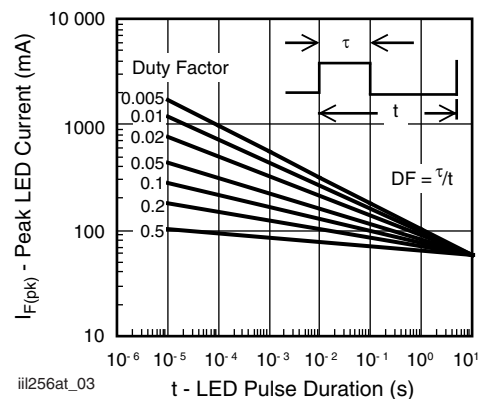


Fig. 3 - Peak LED Current vs. Duty Factor, Tau

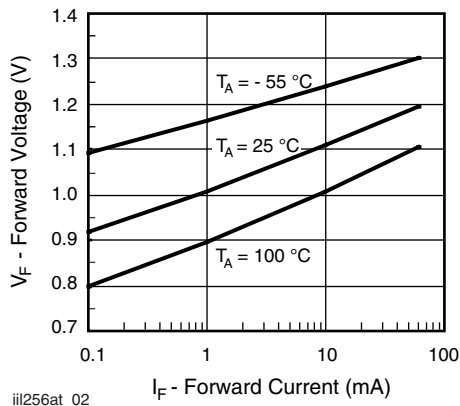
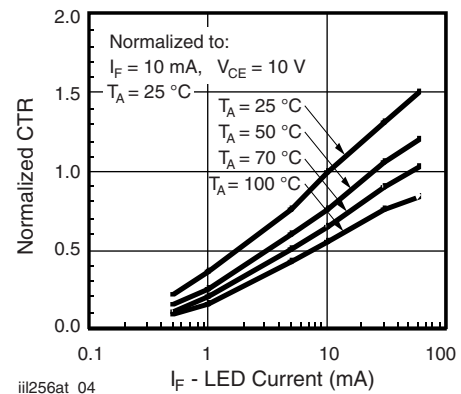


Fig. 2 - Forward Voltage vs. Forward Current


 Fig. 4 - Normalized CTR vs. I_F and T_{amb}

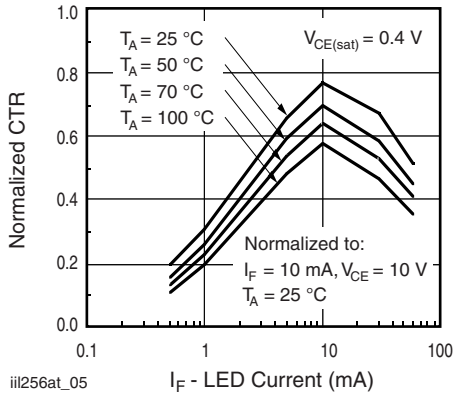


Fig. 5 - Normalized Saturated CTR

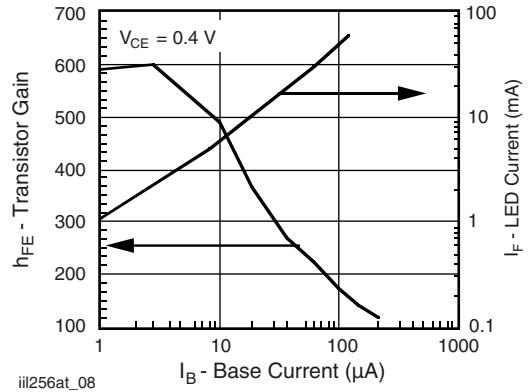


Fig. 8 - Base Current vs. I_F and h_{FE}

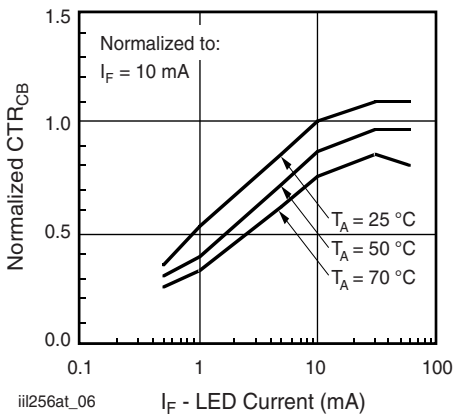


Fig. 6 - Normalized CTR_{CB}

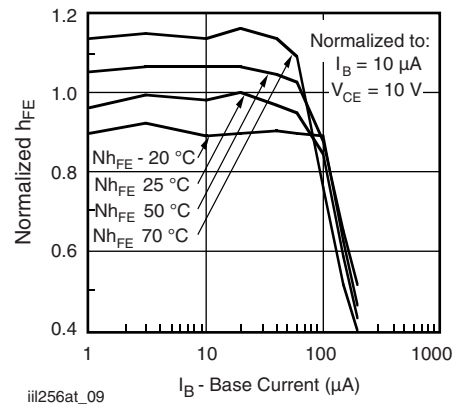


Fig. 9 - Normalized h_{FE} vs. Base Current and Temp.

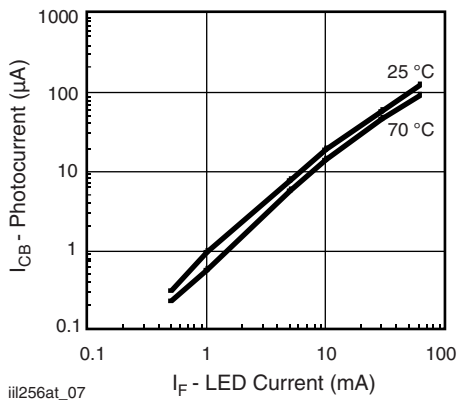


Fig. 7 - Photocurrent vs. LED Current

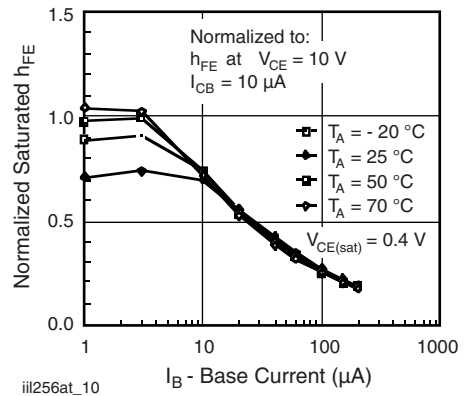


Fig. 10 - Normalized Saturated h_{FE} vs. Base Current

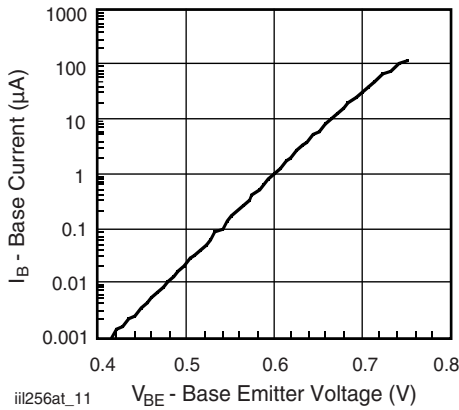


Fig. 11 - Base Emitter Voltage vs. Base Current

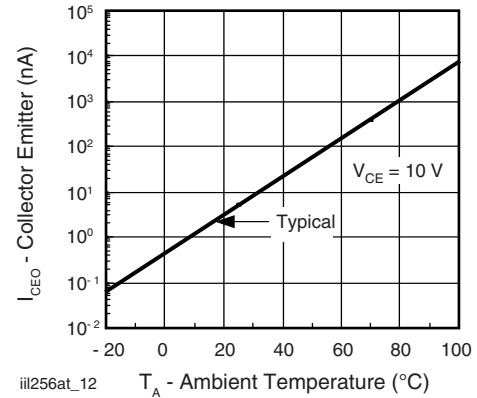
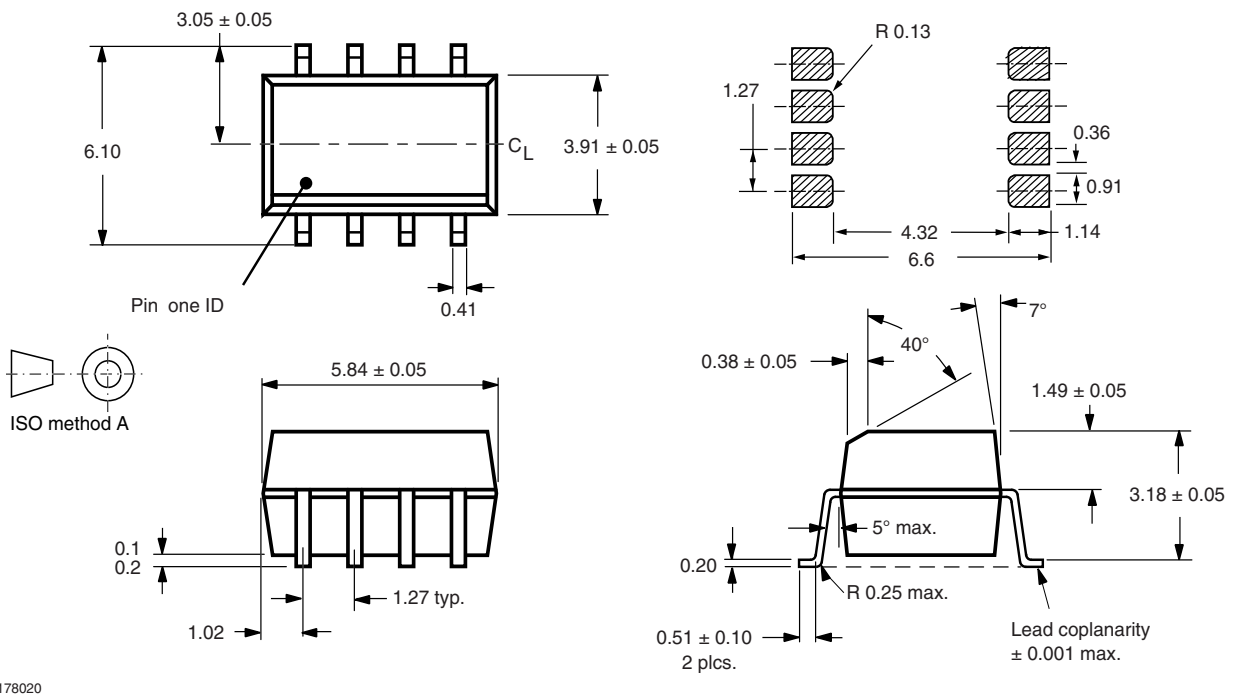


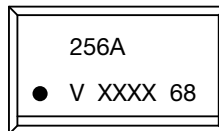
Fig. 12 - Collector-Emitter Leakage Current vs.Temp.

PACKAGE DIMENSIONS in millimeters



i178020

PACKAGE MARKING (example)



Notes

- XXXX = LMC (lot marking code)
- Tape and reel suffix (T) is not part of the package marking



Disclaimer

ALL PRODUCT, PRODUCT SPECIFICATIONS AND DATA ARE SUBJECT TO CHANGE WITHOUT NOTICE TO IMPROVE RELIABILITY, FUNCTION OR DESIGN OR OTHERWISE.

Vishay Intertechnology, Inc., its affiliates, agents, and employees, and all persons acting on its or their behalf (collectively, "Vishay"), disclaim any and all liability for any errors, inaccuracies or incompleteness contained in any datasheet or in any other disclosure relating to any product.

Vishay makes no warranty, representation or guarantee regarding the suitability of the products for any particular purpose or the continuing production of any product. To the maximum extent permitted by applicable law, Vishay disclaims (i) any and all liability arising out of the application or use of any product, (ii) any and all liability, including without limitation special, consequential or incidental damages, and (iii) any and all implied warranties, including warranties of fitness for particular purpose, non-infringement and merchantability.

Statements regarding the suitability of products for certain types of applications are based on Vishay's knowledge of typical requirements that are often placed on Vishay products in generic applications. Such statements are not binding statements about the suitability of products for a particular application. It is the customer's responsibility to validate that a particular product with the properties described in the product specification is suitable for use in a particular application. Parameters provided in datasheets and / or specifications may vary in different applications and performance may vary over time. All operating parameters, including typical parameters, must be validated for each customer application by the customer's technical experts. Product specifications do not expand or otherwise modify Vishay's terms and conditions of purchase, including but not limited to the warranty expressed therein.

Hyperlinks included in this datasheet may direct users to third-party websites. These links are provided as a convenience and for informational purposes only. Inclusion of these hyperlinks does not constitute an endorsement or an approval by Vishay of any of the products, services or opinions of the corporation, organization or individual associated with the third-party website. Vishay disclaims any and all liability and bears no responsibility for the accuracy, legality or content of the third-party website or for that of subsequent links.

Except as expressly indicated in writing, Vishay products are not designed for use in medical, life-saving, or life-sustaining applications or for any other application in which the failure of the Vishay product could result in personal injury or death. Customers using or selling Vishay products not expressly indicated for use in such applications do so at their own risk. Please contact authorized Vishay personnel to obtain written terms and conditions regarding products designed for such applications.

No license, express or implied, by estoppel or otherwise, to any intellectual property rights is granted by this document or by any conduct of Vishay. Product names and markings noted herein may be trademarks of their respective owners.