

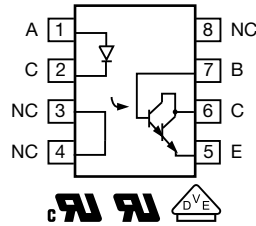

## Optocoupler, Photodarlington Output, Low Input Current, High Gain, With Base Connection

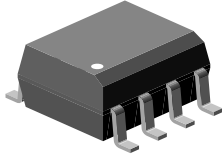

### FEATURES

- Isolation test voltage, 4000 V<sub>RMS</sub>
- Industry standard SOIC-8 surface mountable package
- Standard lead spacing, 0.05"
- Available only on tape and reel (conforms to EIA standard RS481A)
- Compatible with dual wave, vapor phase and IR reflow soldering
- Material categorization: for definitions of compliance please see [www.vishay.com/doc?99912](http://www.vishay.com/doc?99912)



RoHS COMPLIANT

### LINKS TO ADDITIONAL RESOURCES



### DESCRIPTION

The IL221AT, IL222AT, IL223AT are high current transfer ratio (CTR) optocouplers with a gallium arsenide infrared LED emitter and a silicon NPN photodarlington transistor detector.

The device has a CTR tested at 1.0 mA LED current. This low drive current permits easy interfacing from CMOS to LSTTL or TTL.

This optocoupler is constructed in a standard SOIC-8 foot print which makes it ideally suited for high density applications. In addition to eliminating through-hole requirements, this package conforms to standards for surface mount devices.

### AGENCY APPROVALS

- [UL](#)
- [cUL](#)
- [DIN EN 60747-5-5 \(VDE 0884-5\)](#), available with option 1

ORDERING INFORMATION			
<div style="display: flex; justify-content: space-around; align-items: center;"> <div style="border: 1px solid black; padding: 5px; margin: 2px;">I</div> <div style="border: 1px solid black; padding: 5px; margin: 2px;">L</div> <div style="border: 1px solid black; padding: 5px; margin: 2px;">2</div> <div style="border: 1px solid black; padding: 5px; margin: 2px;">2</div> <div style="border: 1px solid black; padding: 5px; margin: 2px;">#</div> <div style="border: 1px solid black; padding: 5px; margin: 2px;">A</div> <div style="border: 1px solid black; padding: 5px; margin: 2px;">T</div> </div> <p style="text-align: center; margin-top: 5px;">PART NUMBER</p>			
AGENCY CERTIFIED / PACKAGE	CTR (%)		
	1 mA		
UL, cUL	≥ 100	≥ 200	≥ 500
SOIC-8	IL221AT	IL222AT	IL223AT



<b>ABSOLUTE MAXIMUM RATINGS</b> ( $T_{amb} = 25\text{ }^{\circ}\text{C}$ , unless otherwise specified)				
PARAMETER	TEST CONDITION	SYMBOL	VALUE	UNIT
<b>INPUT</b>				
Peak reverse voltage		$V_R$	6.0	V
Forward continuous current		$I_F$	60	mA
Power dissipation		$P_{diss}$	90	mW
Derate linearly from 25 °C			1.2	mW/°C
<b>OUTPUT</b>				
Collector emitter breakdown voltage		$BV_{CEO}$	30	V
Emitter collector breakdown voltage		$BV_{ECO}$	5.0	V
Collector base breakdown voltage		$BV_{CBO}$	70	V
$I_{CMAX\ DC}$		$I_{CMAX\ DC}$	50	mA
$I_{CMAX}$	$t < 1.0\text{ ms}$	$I_{CMAX}$	100	mW
Power dissipation		$P_{diss}$	150	mW
Derate linearly from 25 °C			2.0	mW/°C
<b>COUPLER</b>				
Isolation test voltage	$t = 1.0\text{ s}$	$V_{ISO}$	4000	$V_{RMS}$
Total package dissipation (at 25 °C ambient)(LED and detector)		$P_{tot}$	240	mW
Derate linearly from 25 °C			3.2	mW/°C
Storage temperature		$T_{stg}$	-55 to +150	°C
Operating temperature		$T_{amb}$	-55 to +100	°C
Soldering time at 260 °C			10	s

**Note**

- Stresses in excess of the absolute maximum ratings can cause permanent damage to the device. Functional operation of the device is not implied at these or any other conditions in excess of those given in the operational sections of this document. Exposure to absolute maximum ratings for extended periods of the time can adversely affect reliability.

<b>ELECTRICAL CHARACTERISTICS</b> ( $T_{amb} = 25\text{ }^{\circ}\text{C}$ , unless otherwise specified)						
PARAMETER	TEST CONDITION	SYMBOL	MIN.	TYP.	MAX.	UNIT
<b>INPUT</b>						
Forward voltage	$I_F = 1.0\text{ mA}$	$V_F$	-	1.0	1.5	V
Reverse current	$V_R = 6\text{ V}$	$I_R$	-	0.1	100	$\mu\text{A}$
Capacitance	$V_R = 0\text{ V}$ , $f = 1.0\text{ MHz}$	$C_O$	-	25	-	pF
<b>OUTPUT</b>						
Collector emitter breakdown voltage	$I_C = 100\text{ }\mu\text{A}$	$BV_{CEO}$	30	-	-	V
Emitter collector breakdown voltage	$I_E = 100\text{ }\mu\text{A}$	$BV_{ECO}$	5.0	-	-	V
Emitter emitter breakdown voltage	$I_C = 10\text{ }\mu\text{A}$	$BV_{CBO}$	70	-	-	V
Collector emitter capacitance	$V_{CE} = 10\text{ V}$	$C_{CE}$	-	3.4	-	pF
<b>COUPLER</b>						
Saturation voltage, collector emitter	$I_{CE} = 0.5\text{ mA}$	$V_{CEsat}$	-	-	1.0	V
Capacitance (input to output)		$C_{IO}$	-	0.5	-	pF
Resistance (input to output)		$R_{IO}$	-	100	-	G $\Omega$

**Note**

- Minimum and maximum values are tested requirements. Typical values are characteristics of the device and are the result of engineering evaluations. Typical values are for information only and are not part of the testing requirements.



CURRENT TRANSFER RATIO ( $T_{amb} = 25\text{ }^{\circ}\text{C}$ , unless otherwise specified)							
PARAMETER	TEST CONDITION	PART	SYMBOL	MIN.	TYP.	MAX.	UNIT
$I_C/I_F$	$I_F = 1.0\text{ mA}$ , $V_{CE} = 5.0\text{ V}$	IL221AT	$CTR_{DC}$	100	-	-	%
		IL222AT	$CTR_{DC}$	200	-	-	%
		IL223AT	$CTR_{DC}$	500	-	-	%

SAFETY AND INSULATION RATINGS						
PARAMETER	TEST CONDITION	SYMBOL	MIN.	TYP.	MAX.	UNIT
Climatic classification	According to IEC 68 part 1		-	55 / 100 / 21	-	
Comparative tracking index		CTI	175	-	399	
$V_{IOTM}$			6000	-	-	V
$V_{IORM}$			560	-	-	V
$P_{SO}$			-	-	350	mW
$I_{SI}$			-	-	150	mA
$T_{SI}$			-	-	165	$^{\circ}\text{C}$
Creepage distance			4	-	-	mm
Clearance distance			4	-	-	mm
Insulation thickness			0.2	-	-	mm

**Note**

- As per IEC 60747-5-2, § 7.4.3.8.1, this optocoupler is suitable for “safe electrical insulation” only within the safety ratings. Compliance with the safety ratings shall be ensured by means of protective circuits.

**TYPICAL CHARACTERISTICS** ( $T_{amb} = 25\text{ }^{\circ}\text{C}$ , unless otherwise specified)

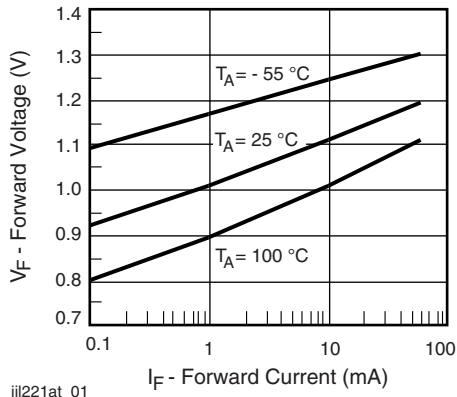

iii221at\_01

Fig. 1 - Forward Voltage vs. Forward Current

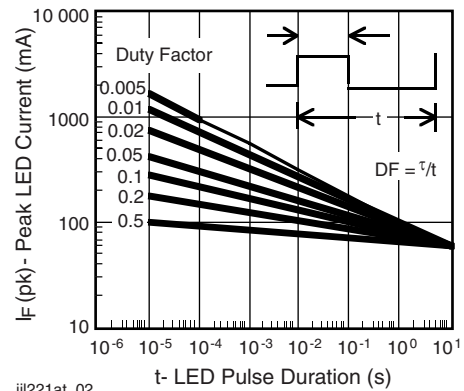

iii221at\_02

Fig. 2 - Peak LED Current vs. Duty Factor,  $\tau$

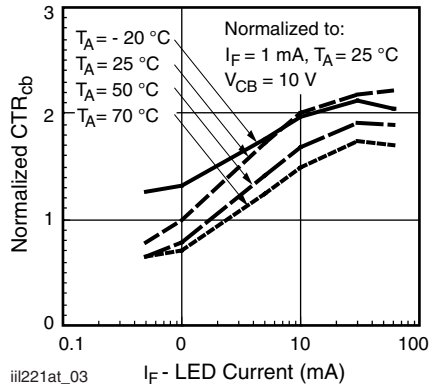

Fig. 3 - Normalized  $CTR_{cb}$  vs.  $I_F$

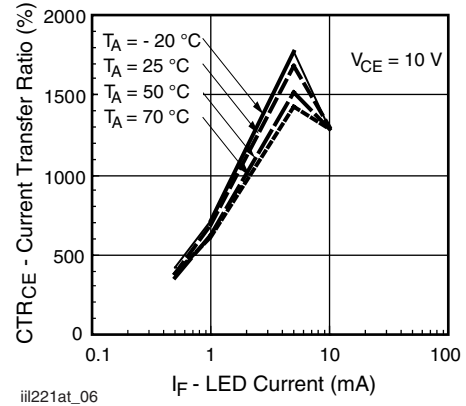

Fig. 6 - CTR vs. LED Current

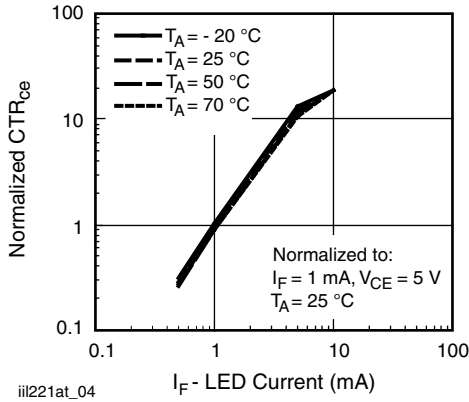

Fig. 4 - Normalized  $CTR_{CE}$  vs. LED Current

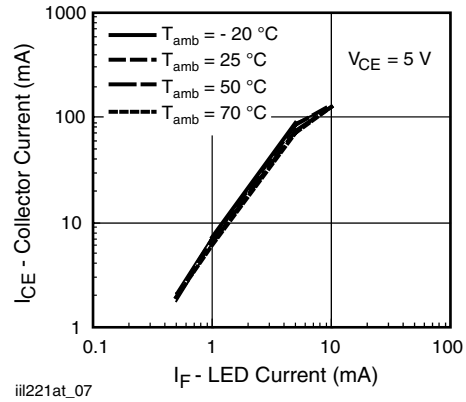

Fig. 7 - Collector Current vs. LED Current

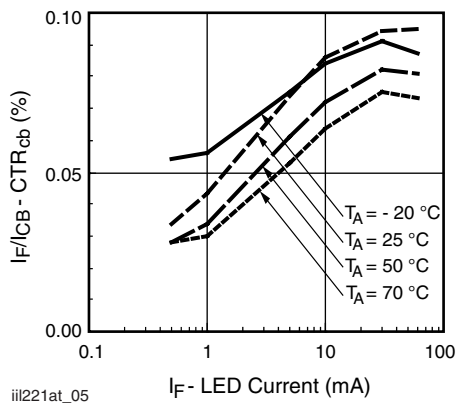

Fig. 5 -  $CTR_{CE}$  vs. LED Current

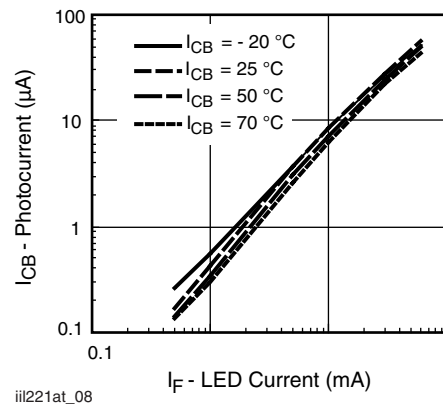

Fig. 8 - Photocurrent vs. LED Current

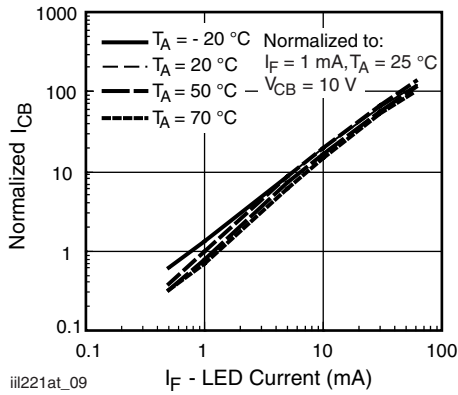

Fig. 9 - Normalized  $I_{CB}$  vs.  $I_F$

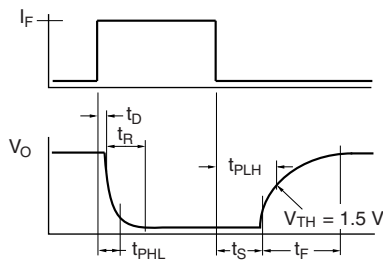
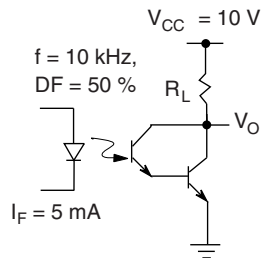

Fig. 10 - Switching Timing



iii221at\_11

Fig. 11 - Switching Schematic

## PACKAGE DIMENSIONS in inches (millimeters)

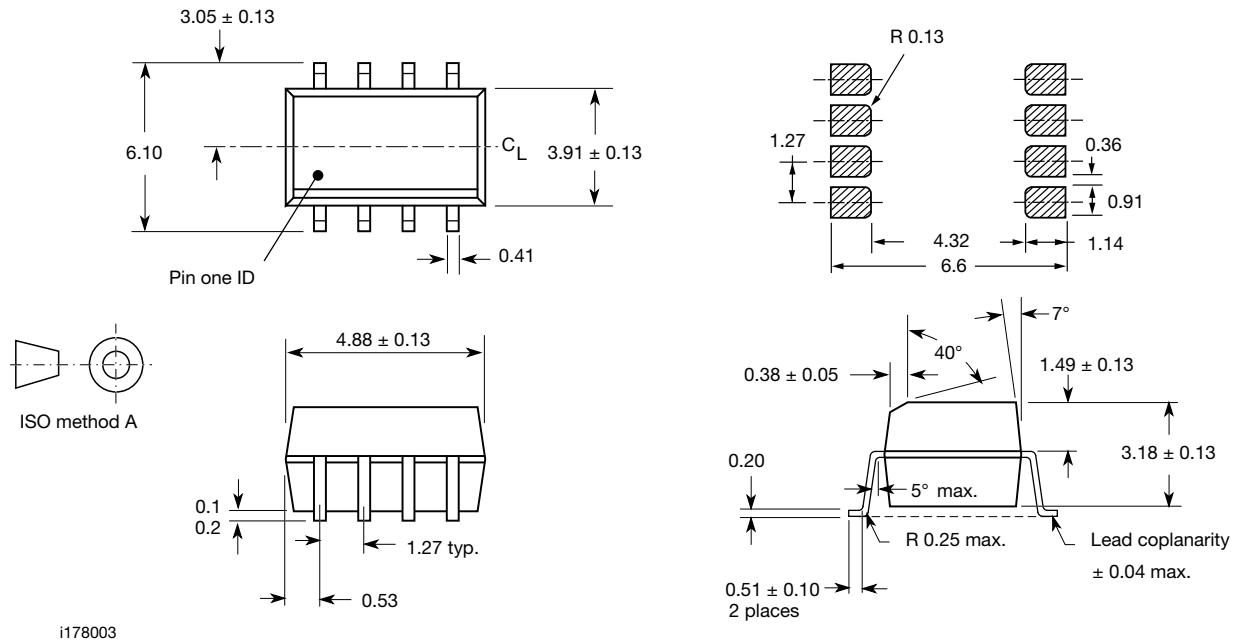

## PACKAGE MARKING (example)

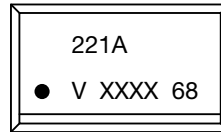

Fig. 12 - Example of IL221AT

### Notes

- XXXX = LMC (lot marking code)
- Tape and reel suffix (T) is not part of the package marking



## Disclaimer

ALL PRODUCT, PRODUCT SPECIFICATIONS AND DATA ARE SUBJECT TO CHANGE WITHOUT NOTICE TO IMPROVE RELIABILITY, FUNCTION OR DESIGN OR OTHERWISE.

Vishay Intertechnology, Inc., its affiliates, agents, and employees, and all persons acting on its or their behalf (collectively, "Vishay"), disclaim any and all liability for any errors, inaccuracies or incompleteness contained in any datasheet or in any other disclosure relating to any product.

Vishay makes no warranty, representation or guarantee regarding the suitability of the products for any particular purpose or the continuing production of any product. To the maximum extent permitted by applicable law, Vishay disclaims (i) any and all liability arising out of the application or use of any product, (ii) any and all liability, including without limitation special, consequential or incidental damages, and (iii) any and all implied warranties, including warranties of fitness for particular purpose, non-infringement and merchantability.

Statements regarding the suitability of products for certain types of applications are based on Vishay's knowledge of typical requirements that are often placed on Vishay products in generic applications. Such statements are not binding statements about the suitability of products for a particular application. It is the customer's responsibility to validate that a particular product with the properties described in the product specification is suitable for use in a particular application. Parameters provided in datasheets and / or specifications may vary in different applications and performance may vary over time. All operating parameters, including typical parameters, must be validated for each customer application by the customer's technical experts. Product specifications do not expand or otherwise modify Vishay's terms and conditions of purchase, including but not limited to the warranty expressed therein.

Hyperlinks included in this datasheet may direct users to third-party websites. These links are provided as a convenience and for informational purposes only. Inclusion of these hyperlinks does not constitute an endorsement or an approval by Vishay of any of the products, services or opinions of the corporation, organization or individual associated with the third-party website. Vishay disclaims any and all liability and bears no responsibility for the accuracy, legality or content of the third-party website or for that of subsequent links.

Except as expressly indicated in writing, Vishay products are not designed for use in medical, life-saving, or life-sustaining applications or for any other application in which the failure of the Vishay product could result in personal injury or death. Customers using or selling Vishay products not expressly indicated for use in such applications do so at their own risk. Please contact authorized Vishay personnel to obtain written terms and conditions regarding products designed for such applications.

No license, express or implied, by estoppel or otherwise, to any intellectual property rights is granted by this document or by any conduct of Vishay. Product names and markings noted herein may be trademarks of their respective owners.