

Ewon[®] Cosy+
INSTALLATION GUIDE

IG-0031-00 1.3
Publication date 14/09/2023



Important User Information

Disclaimer

The information in this document is for informational purposes only. Please inform HMS Networks of any inaccuracies or omissions found in this document. HMS Networks disclaims any responsibility or liability for any errors that may appear in this document.

HMS Networks reserves the right to modify its products in line with its policy of continuous product development. The information in this document shall therefore not be construed as a commitment on the part of HMS Networks and is subject to change without notice. HMS Networks makes no commitment to update or keep current the information in this document.

The data, examples and illustrations found in this document are included for illustrative purposes and are only intended to help improve understanding of the functionality and handling of the product. In view of the wide range of possible applications of the product, and because of the many variables and requirements associated with any particular implementation, HMS Networks cannot assume responsibility or liability for actual use based on the data, examples or illustrations included in this document nor for any damages incurred during installation of the product. Those responsible for the use of the product must acquire sufficient knowledge in order to ensure that the product is used correctly in their specific application and that the application meets all performance and safety requirements including any applicable laws, regulations, codes and standards. Further, HMS Networks will under no circumstances assume liability or responsibility for any problems that may arise as a result from the use of undocumented features or functional side effects found outside the documented scope of the product. The effects caused by any direct or indirect use of such aspects of the product are undefined and may include e.g. compatibility issues and stability issues.

Copyright © 2022 HMS Networks

Table of Contents

1. Preface	1
1.1. About This Document	1
1.2. Document History	1
1.3. Related Documents	1
1.4. Trademark Information	1
2. Product Summary	2
2.1. Type & Part Numbers	2
2.2. Hardware General Specification	2
2.3. Typical Applications for Ewon® Cosy+	2
3. Safety, Environmental & Regulatory Information	3
3.1. Scope	3
3.2. Power Supply	3
3.3. Applicable Directives, Standards and Compliance	3
3.4. Field Implementation & Environmental Conditions	3
3.4.1. General Restriction	3
3.4.2. Ingress Protection	3
3.4.3. Mechanical Dimensions	3
3.4.4. Mounting Recommendations	4
3.4.5. Ventilation	6
3.4.6. Cabling Rules	7
3.4.7. Environmental Conditions	7
3.4.8. Earthing	8
3.5. Internal Battery	8
4. Hardware Description	9
4.1. Label	9
4.2. Overall Description	11
4.2.1. Front Panel	11
4.2.2. Upper Side	12
4.2.3. LED Indicators	12
4.3. LAN Switch Specifications	14
4.3.1. Boot Process	14
4.3.2. LAN Switch Configuration	14
4.4. Radio Communication Models	14
5. Ewon® Cosy+ models	16
5.1. Ewon® Cosy+ Ethernet - EC71330	16
5.1.1. Technical Specifications - EC71330	17
5.2. Ewon® Cosy+ WiFi - EC7133J	17
5.2.1. Technical Specifications - EC7133J	19
5.3. Ewon® Cosy+ 4G NA - EC7133K	20
5.3.1. Technical Specifications - EC7133K	21
5.4. Ewon® Cosy+ 4G EU - EC7133L	21
5.4.1. Technical Specifications - EC7133L	23
5.5. Ewon® Cosy+ 4G APAC - EC7133M	23
5.5.1. Technical Specifications - EC7133M	24
6. IP Address and Access to the Web Configuration	26
6.1. Factory Default IP Settings	26
6.2. Powering On	26

6.3. Connecting to the LAN IP Address	26
6.4. Ewon® Cosy+ Web Interface	26
7. Troubleshooting	28
7.1. Standard Boot Process	28
7.2. Reset of the Ewon® Cosy+	28
7.2.1. First Reset Level: User Reset	28
7.2.2. Second Reset Level: Factory Reset	29
7.2.3. Reset Matrix	30
Appendix A. Appendix	31
1. Main Connector	31
2. Specification of the External Power Supply	31
3. Digital Output & Digital Inputs	32
3.1. Possible Features of the DI & DO	33

1. Preface

1.1. About This Document

The present Installation Guide describes the hardware of the Ewon® Cosy+ which is an industrial gateway / router fully compatible with the [Talk2m cloud connectivity services](#).

For additional related documentation and file downloads, please visit www.ewon.biz/support.

1.2. Document History

Version	Date	Description
1.0	08-01-2020	First release
1.1	25-06-2022	Temperature specification update
1.2	20-09-2022	Added Cosy+ Models EC7133J/K/L/M specifications
1.3	28/11/2022	General layout review
1.4	27/03/2023	Recent upgrade to UL/IEC/EN 62368-1 Third edition for Ewon Cosy

1.3. Related Documents

Document	Author	Document ID
eBuddy	HMS	AUG-0063-00
User Manual for Ewon® Cosy+ Devices	HMS	UM-0006-00
General Reference Guide for Ewon® Cosy+	HMS	RG-0011-00

1.4. Trademark Information

Ewon® is a registered trademark of HMS Networks SA. All other trademarks mentioned in this document are the property of their respective holders.

2. Product Summary

2.1. Type & Part Numbers

There are 5 models of the Ewon® Cosy+ each proposing different communication media.

They include the following part numbers:

Part number	Model	Model name	Description
EC71330_00MA	01702	Ewon® Cosy+ ETH	LAN / WAN – 4 Ethernet ports only
EC71330_00MA	11702	Ewon® Cosy+ ETH (Realtek)	LAN / WAN – 4 Ethernet ports only (Realtek)
EC7133J_00MA	04002	Ewon® Cosy+ WiFi	LAN / WAN, Wi-Fi – 4 Ethernet ports, WiFi Modem (802.11 a/b/g/n)
EC7133K_00MA	04102	Ewon® Cosy+ 4G NA	LAN / WAN, 4G quad-band – 4 Ethernet ports, Cellular Modem (NA)
EC7133L_00MA	04302	Ewon® Cosy+ 4G EU	LAN / WAN, 4G quad-band – 4 Ethernet ports, Cellular Modem (EU)
EC7133M_00MA	04402	Ewon® Cosy+ APAC	LAN / WAN, 4G quad-band – 4 Ethernet ports, Cellular Modem (APAC)

The part number syntax is explained in the [Label \(page 9\)](#) section.

Technical specification and certification by model can be found in the [Ewon Cosy+ models \(page 16\)](#) section.

2.2. Hardware General Specification

Characteristic	Value
Design	Industrial design: <ul style="list-style-type: none"> • 24Vdc power supply • DIN Rail mounting • Extended temperature: -25°C to +60°C
Clock	Backed up real time clock (RTC) Backup battery lifetime has 10 years expectancy
Ethernet Interface	LAN Ethernet port 10 / 100 Mbps
Digital Input	2
Digital Output	1
Mounting	Latch is DIN Rail EN50022 compliant.

2.3. Typical Applications for Ewon® Cosy+

You can use the Ewon® Cosy+ for :

- Remote access of Ethernet and / or USB devices using Talk2m connection

The Ewon® Cosy+ should not be used

- As a pure Ethernet switch.

3. Safety, Environmental & Regulatory Information

3.1. Scope

This chapter addresses safety, environmental and regulatory information for the Ewon® Cosy+.

3.2. Power Supply

The external power supply is a third-party device that is not part of this certification.

The equipment should be supplied from external, separately provided power supply 12-24Vdc, 30W min., certified for 60°C and for altitudes up to 2000m. Power supply should be separately certified according to UL/IEC 62368-1 with ES1, PS2 output.

For more information, refer to [Specification of the External Power Supply \(page 31\)](#) section.

3.3. Applicable Directives, Standards and Compliance

The Ewon® Cosy+ series described in the present document complies with the CE and the FCC regulations. Each Ewon® Cosy+ variant is certified for the region it is intended for.

You can refer to the [Ewon Technical Support Website](#) for all documents related to certifications such as CE Declaration of Conformity, FCC Declaration of Conformity, UL/CB Certificate and EC Type Examination Certificate.

3.4. Field Implementation & Environmental Conditions

3.4.1. General Restriction

This equipment is not suitable for use in locations where children are likely to be present.

3.4.2. Ingress Protection

The Ewon® Cosy+ has an IP20 protection grade. Therefore, the Ewon® Cosy+ is **NOT** suitable for outdoor mounting. It must be integrated in an electrical cabinet, protected from excessive heat, humidity and dust.

Do not push any sharp object into the air vents or openings of the equipment.

3.4.3. Mechanical Dimensions

All units are expressed in millimeters "*mm*" and are rounded up.

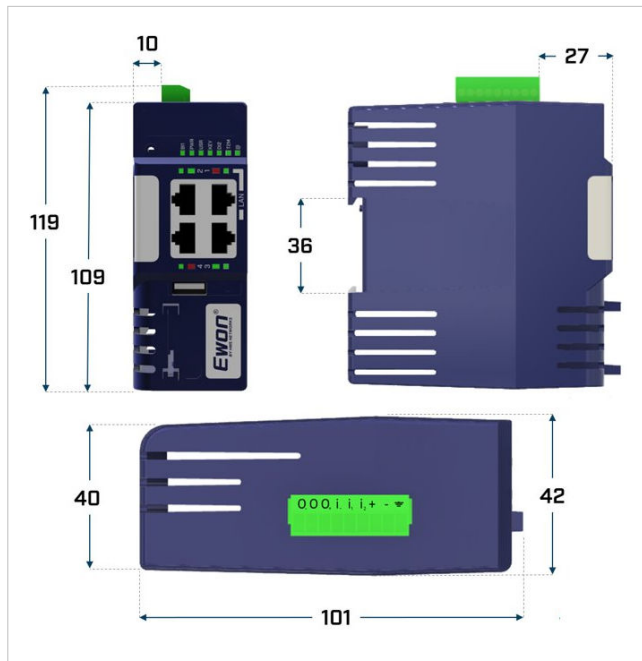

Figure 1. Mechanical dimensions of the Ewon® Cosy+

3.4.4. Mounting Recommendations

The product is intended to be mounted vertically with the main connector on the top.

The normal mounting position of the Ewon® Cosy+ is to be mounted on a horizontal Omega type DIN rail.

1. Mounting the unit on DIN-rail [Omega type DIN-rail (EN 50022)]

Pull the slide lock (located at the bottom of the back-side of the unit) downwards and present the unit in front of the DIN rail. Tilt the Ewon® Cosy+ upwards in order to hang it on the upper edge of the DIN rail by its hook. Gently tilt the unit downwards until it finds its original position. Pull the slide lock upwards to fix and lock the unit on the DIN rail.

2. Removing the unit from DIN-rail [Omega type DIN-rail (EN 50022)]

Release the unit by pulling the slide lock downwards while gently tilting the unit upwards. Free the unit by unhooking it from the upper rail edge.

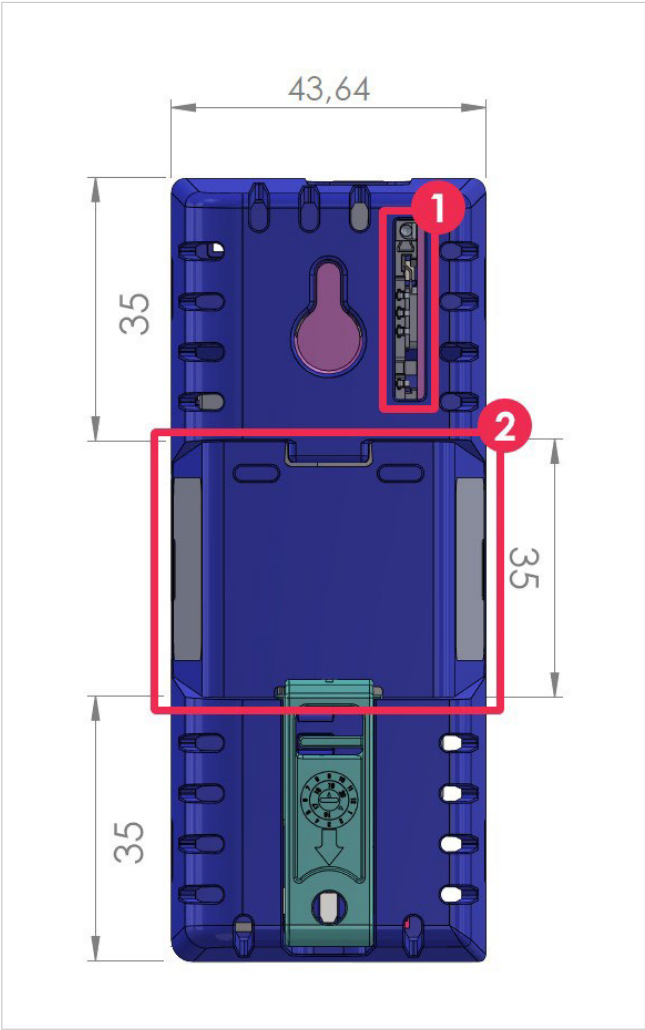

Figure 2. DIN Rail Mounting Position

#	Description
1	SIM card slot
2	DIN rail mounting bracket

• **Mounting the unit on a wall**

If there is no DIN rail available for the mounting, you can also fix your Ewon[®] Cosy+ directly on the wall.

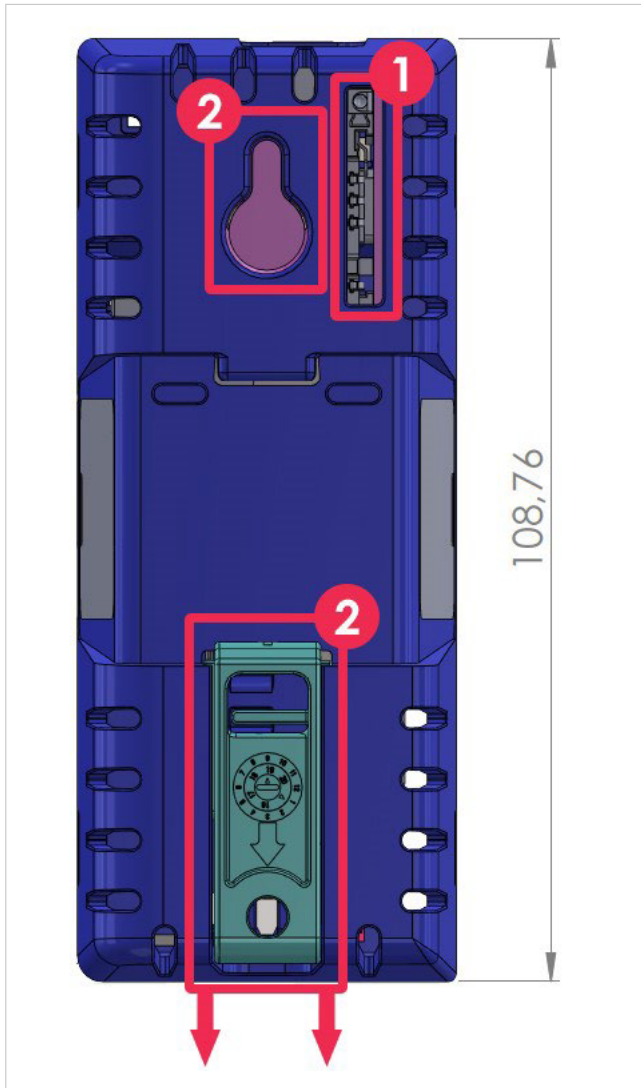

Figure 3. Wall Mounting Position

#	Description
1	SIM card slot
2	<ul style="list-style-type: none"> • Wall Mounting Bracket (suggested screw dimensions 4,2 x 32 mm) • DIN Rail Clip with a hole for a second screw



CAUTION

Set the screws in both wall mounting brackets to prevent accidents.

3.4.5. Ventilation

To ensure a proper ventilation of the equipment, a free gap of at least 2 cm must be respected in front of all upper and lower ventilation openings of the unit.

A free gap of at least 1 cm must be respected on each side of the unit.

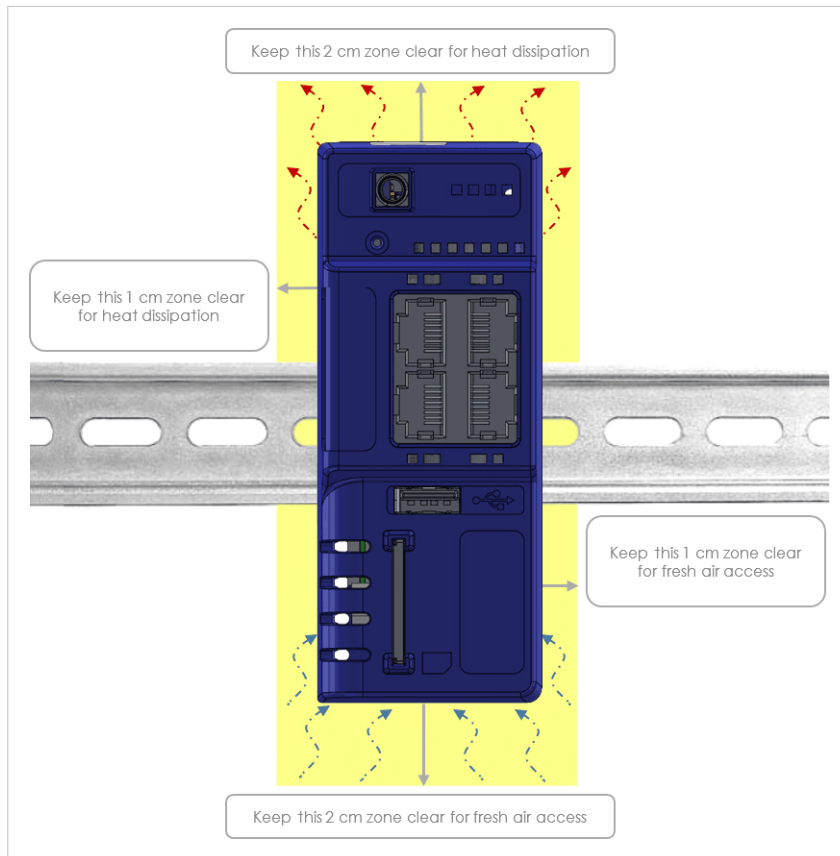

Figure 4. Free gap surrounding the Ewon® Cosy+ for heat dissipation.

3.4.6. Cabling Rules

Shielded cables must be used for Ethernet and USB connectivity of the Ewon® Cosy+ to comply with the EMC requirements.

The USB cable must be:

- Shorter than 3m
- USB 2.0 of type A (on the Ewon® Cosy+ side)
- Minimum current per contact: 0.5A (or better)



CAUTION

To prevent accidentally pulling out wires, make sure the cables are firmly attached to wire connectors.

For screw connectors, make sure that screws are properly tightened as well as routing the equipment wires separately from other high voltage wires.

3.4.7. Environmental Conditions

The equipment operates properly within the following environmental limits if it has been correctly mounted according our recommendations:

Table 1. Environmental conditions

Operating temperature	-25°C to +60°C
Operating relative humidity	10 to 95% non-condensing
Operating altitude	Up to maximum 2000m
Storage temperature	-30°C to +70°C
Storage altitude	Up to maximum 3000m
Storage humidity	10 to 95% non-condensing

**IMPORTANT**

If the mounting situation mentioned is not applied, the specified operating temperature has to be derated to -25°C to +40°C.

3.4.8. Earthing

Earthing the Ewon® Cosy+ is necessary to eliminate unwanted transient currents, and to conform to the EMC requirements.

Therefore, a functional earth (FE) terminal is available on the main connector as shown in [Specification of the External Power Supply section \(page 31\)](#). Connect this FE terminal directly to allow impedance ground.

Shielded cables have to be used for Ethernet and USB to comply with the EMC requirements.

3.5. Internal Battery

The Ewon® Cosy+ contains a CR2032 battery.

This battery is used to maintain the real time clock up-to-date even when the unit is not powered.

The following list exposes the risks and recommendations regarding the battery:

- Risk of explosion if the battery is replaced by an incorrect type. The battery is not intended to be replaced by the consumer: the product shall be returned to the manufacturer for replacement.
- Do not ingest the battery as it might provoke chemical burn hazard.
- Keep new and used batteries away from children.
- If the cell battery is swallowed, it can cause several internal burns in just 2 hours and can lead to death.
- If the equipment's enclosure does not close securely, stop using the product and keep it away from children.
- If you think batteries might have been swallowed or placed inside any part of the body, seek immediate medical attention.

4. Hardware Description

4.1. Label

The identification label of the Ewon® Cosy+ is placed on the right hand side of the housing.

The different parts of the label are described as follows:

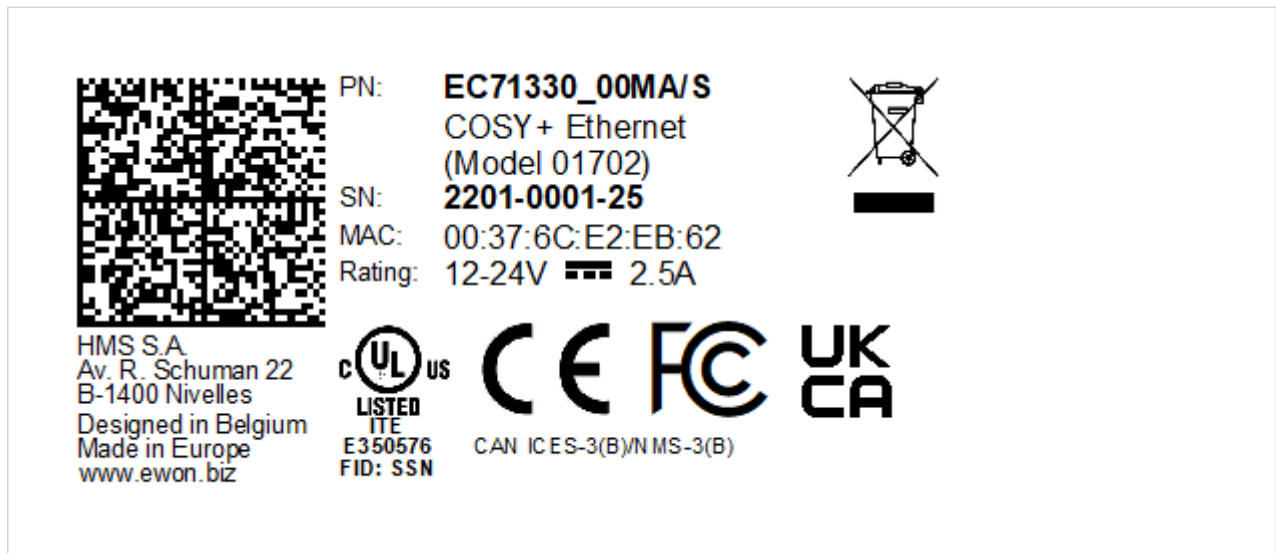



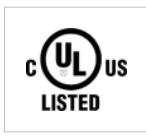



Figure 5. Ewon® Cosy+ Label Example

The label can have variant marks depending on the model of the Ewon® Cosy+, you can find these variants in the [Ewon® Cosy+ models \(page 16\)](#) section.

Table 2. Label of an Ewon® Cosy+

Label	Description
PN	Part Number (see syntax table below) Product Name (ex: Cosy+ Ethernet) Model number (ex: Model 01702)
SN	Serial Number in the form of YYWW-SSSS-PP <ul style="list-style-type: none"> YY: Year of production WW: Week of production SSSS: Sequential manufacturing order PP: Product type
MAC	MAC address of the Ethernet adapter (WAN side)
Rating	Power supply requirements
Marks	CE, UL, ... logos if applicable

The applicable marks on the Ewon® Cosy+ are the following:

Marks	Description
	Conformité Européenne or European Conformity (EC)
	UL Listed — Underwriters Laboratories
	FCC — Federal Communications Commission
	UKCA – UK Conformity Assessed
	JAPAN MIC – GITEKI CERTIFICATION

The following tables explain the Part Number syntax:

Table 3. Example of a part number syntax with EC7133m_ccLL[suffix]

EC	Name of product family	EC for Ewon Cosy+	
7	Hardware platform number	7	Cosy+ platform
1	Communication options 1	1	1 Ethernet
3	Communication options 2	3	3 Ethernet
3	Field communication option	3	USB
m	Modem communication option	0 J K, L, M	No modem WiFi 4G modem North America, Europe, Asia-Pacific
cc	Contains one or more characters (digits and/or letters)	00	No software option
LL	Defines the firmware language	MA	Regroups EN, FR, DE, ES and IT
[suffix]	Optional “ / ” character Defines the compliances of the unit	S	Compliance with the UL / IEC / EN 60950 standard

4.2. Overall Description

4.2.1. Front Panel



Figure 6. Front panel of the Ewon® Cosy+

Table 4. Description of the front panel

#	Description
1	Reset button
2	Status LEDs
3	LAN/WAN Ethernet ports and corresponding status LEDs: <ul style="list-style-type: none"> • Orange: WAN port • Green: LAN port
4	USB slot
5	SD card slot

4.2.2. Upper Side

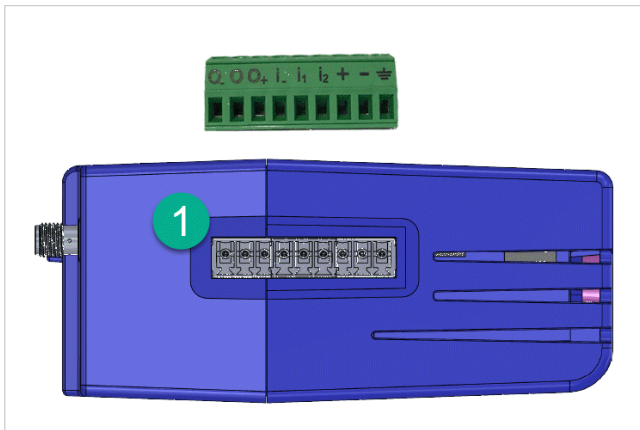

Figure 7. Main connector and plug of the Ewon® Cosy+

For more information about the connector, refer to [Main Connector \(page 31\)](#) section.

4.2.3. LED Indicators

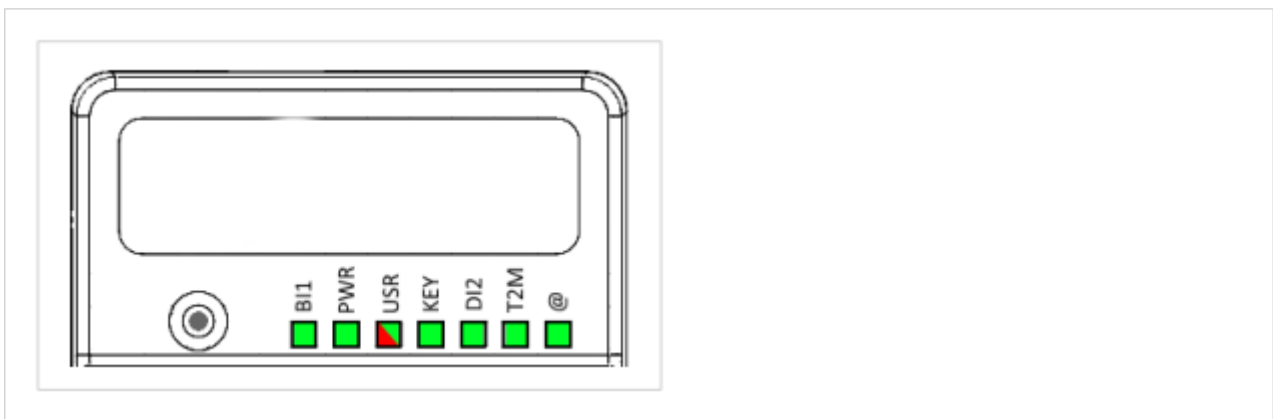

Figure 8. Status LEDs overview - All versions

Table 5. On all versions

Label	Description
B11	<i>Reset Button</i> Steady green = reset button is being pressed
PWR	<i>Power</i> Steady green = unit is powered on
USR	<i>User</i> <ul style="list-style-type: none"> Blinking green slowly = Unit is ok Orange pattern = special attention required
KEY	<i>Digital IN 1</i> Green = ON : Signal on Input 1 detected <i>See Digital Output & Digital Inputs (page 32) section.</i>
D12	<i>Digital IN 2</i> Green = ON : Signal on Input 2 detected <i>See Digital Output & Digital Inputs (page 32) section.</i>
T2M	<i>Talk2m</i> <ul style="list-style-type: none"> Green = ON : Talk2m VPN connection established Blinking green = A user is connected to this Ewon Cosy+ through Talk2m (= active remote connection) <i>See Digital Output & Digital Inputs (page 32) section.</i>
@	<i>Internet</i> Steady green = Internet is configured on the Ewon Cosy+

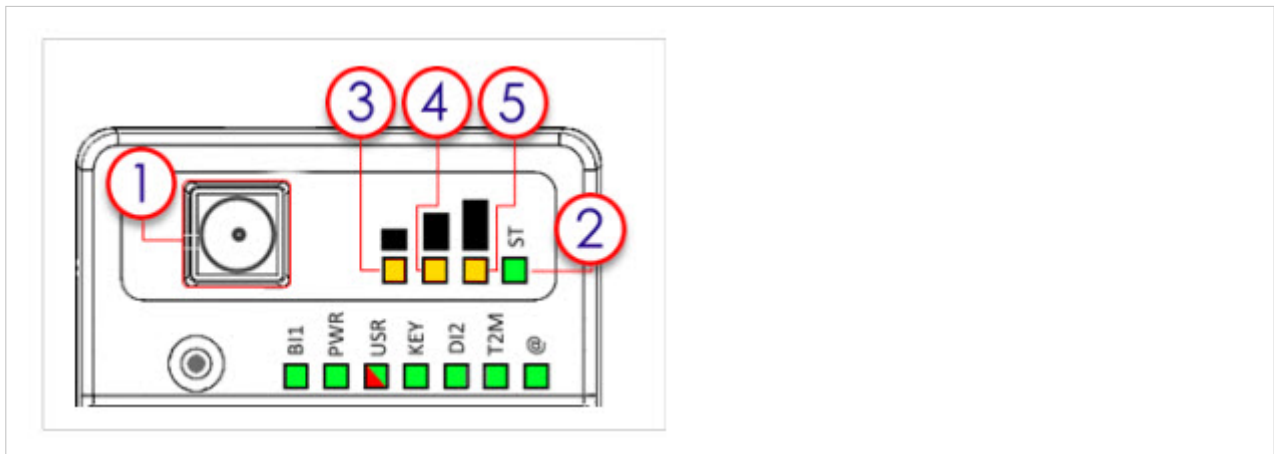

Figure 9. Status Led's for Ewon® Cosy+ devices with embedded modem

Table 6. WiFi (EC7133J) & Cellular version (EC7133K, C7133L, EC7133M)

Label	Description
1	Connector for WiFi or Cellular Antenna
2	<i>Modem Status</i> <ul style="list-style-type: none"> Steady green = connected Blinking green = Local Wifi Access Point enabled
3	<i>Reception signal level</i> Steady orange = Poor signal
4	<i>Reception signal level</i> Steady orange = Signal is OK
5	<i>Reception signal level</i> Steady orange = Signal is good

4.3. LAN Switch Specifications

4.3.1. Boot Process

After powering on or requesting a reboot of the Ewon® Cosy+, a delay (approximately 2 to 4 sec) is required before the LAN switch feature is fully operational.



IMPORTANT

The Ewon® Cosy+ should **not** be used as a pure Ethernet switch as short interruptions of the switch interface need to be taken into consideration.



NOTE

The Ewon® Cosy+ may reboot when it can no longer run a configuration. The goal of the reboot is to restore the communication channels and to ensure that the configuration is applied.

4.3.2. LAN Switch Configuration

At the very first boot or after a reset level 2, the Ethernet ports scheme will be configured as follows:

- Port #1 : LAN
- Port #2 : LAN
- Port #3 : LAN
- Port #4: WAN



NOTICE

Ethernet port#1 must be used for maintenance operation (such as update).

The Ethernet port's functionality can be configured as wanted except for the port #1 which always remains in LAN mode.



TIP

You can identify the LAN port by its green LED and the WAN ports by their orange LEDs.

4.4. Radio Communication Models



IMPORTANT

This device is intended to be used in fixed or mobile applications only (not for portable applications).



IMPORTANT

The antenna used for this transmitter has to be installed in a space providing a safe distance of at least 20 cm without encountering anyone and cannot be located or operating in conjunction with any other antenna or transmitter.

Technical specifications and certifications by models can be found in the [Ewon® Cosy+ models \(page 16\)](#) section.

5. Ewon® Cosy+ models



NOTE

The Ewon® Cosy+ exists in different models in order to adapt to any local internet connection type.

5.1. Ewon® Cosy+ Ethernet - EC71330

- Order code: EC71330_00MA
- Model numbers: 01702 & 11702

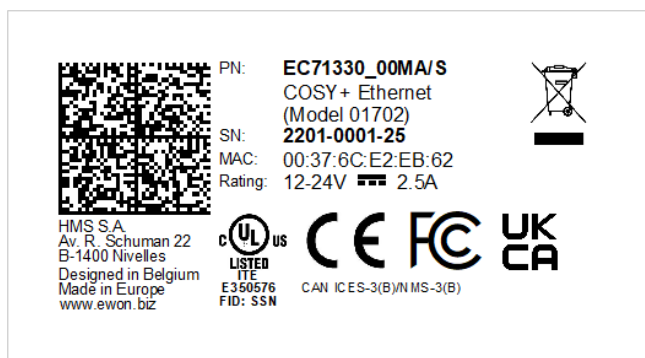

Figure 10. Side sticker of the Ewon® Cosy+ Ethernet - EC71330

5.1.1. Technical Specifications - EC71330

Specifications	Details
WAN Connectivity	Ethernet
WAN Ethernet	Up to 3 ports, 10/100 Mb Ethernet
LAN Ethernet	Up to 4 ports, 10/100 Mb Ethernet
Field interface	Up to 10 USB 2.0 connections, female connector 2.0
SD Card Reader	YES, for Cosy commissioning (firmware upgrade, backup, Talk2m registration)
Mechanics	Dimensions: 108,80 x 99 x 43,60 mm (H x D x W). DIN rail or wall screw fixing system.
Weight	198 grams
Power Supply	12-24 VDC +/-20%, LPS
Extended Temperature Range	Operating: -25°C to +60°C, 10 to 95% relative humidity (noncondensing) Storage: -30°C to +70°C, 10 to 95% relative humidity (noncondensing)
Hardware	1xDO: open drain (MOSFET) 200 mA; isolation 1.5 kV 2xDI: 0 to 24 VDC; 1.5 kV isolation
Marking	CE, cULus, FCC, UKCA, CAN ICES-3 (B) / NMS-3 (B)
Warranty	36 months
Type Tests	Temperature - Operating and Storage tested according to: <ul style="list-style-type: none"> • IEC 60068-2-1 Cold test • IEC 60068-2-2 Dry heat test • IEC 60068-2-14 Change of temperature • IEC 60068-2-30 Cyclic damp heat test Vibration and shocks tested according to: <ul style="list-style-type: none"> • IEC 60068-2-27 Bumps • IEC 60068-2-64 Vibration (broad-band random) • IEC 60068-2-6 Vibration (sinusoidal)
CE	Compliant with: <ul style="list-style-type: none"> • EMC directive 2014/30/EU (Immunity: industrial level) • ROHS2 2011/65/EU directive with amendment 2015/863 REACH regulation
UKCA	Compliant with: <ul style="list-style-type: none"> • Electromagnetic Compatibility Regulations 2016 • The Restriction of the Use of Certain Hazardous Substances in Electrical and Electronic Equipment Regulations 2012.
FCC/IC	This product complies with the Part 15 of the FCC rules
Japan	This device complies with Japanese regulations
Safety	The product fulfils the requirements of: <ul style="list-style-type: none"> • EN IEC 62368-1:2020 + A11:2020 • UL 62368-1 Third Edition • CAN/CSA C22.2 No. 62368-1: 19 Third Edition

5.2. Ewon® Cosy+ WiFi - EC7133J

- Order code: EC7133J_00MA
- Model number: 04002

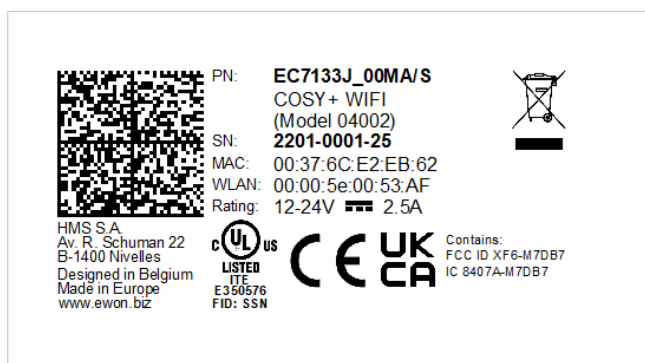

Figure 11. First side sticker of the Ewon® Cosy+ WiFi - EC7133J

5.2.1. Technical Specifications - EC7133J

Specifications	Details
WAN Connectivity	Ethernet or WiFi: 802.11 a/b/g/n.
Frequencies	Channels: 1 to 11(inclusive)
Security	<ul style="list-style-type: none"> Client: WPA, WPA2 and WEP Access Point: WPA2
Antenna Connector	RP-SMA female connector
Antenna	<p>Included in the delivery. Antenna covering the ISM band for WLAN system 802.11 a/b/g/n. The antenna has SMA connector and can be tilted 90 degrees.</p> <ul style="list-style-type: none"> Client: Frequency and gain: 2.4 GHz / 2.0 dBi max and 5 GHz / 4.5 dBi max.; impedance: 50 Ohms. Access point: Frequency: 2.4 GHz; gain: 2.0 dBi max; impedance: 50 Ohms
WAN Ethernet	Up to 3 ports, 10/100 Mb Ethernet
LAN Ethernet	Up to 4 ports, 10/100 Mb Ethernet
Field interface	Up to 10 USB 2.0 connections, female connector 2.0
SD Card reader	YES, for Cosy commissioning (firmware upgrade, backup, Talk2m registration)
Mechanicals	Dimensions: 108,80 x 99 x 43,60 mm (H x D x W). DIN rail or wall screw fixing system
Weight	214 grams
Power Supply	12-24 VDC +/-20%, LPS
Extended Temperature Range	<ul style="list-style-type: none"> Operating: -25°C to +60°C, 10 to 95% relative humidity (non condensing) Storage: -30°C to +70°C, 10 to 95% relative humidity (non condensing)
Hardware	<ul style="list-style-type: none"> 1xDO: open drain (MOSFET) 200 mA; isolation 1.5 kV. 2xDI: 0 to 24 VDC; 1.5 kV isolation.
Marking	CE, cULus, FCC, UKCA, Japan, RCM
Warranty	36 months
Type Tests	<p>Temperature - Operating and Storage tested according to:</p> <ul style="list-style-type: none"> IEC 60068-2-1 Cold test IEC 60068-2-2 Dry heat test IEC 60068-2-14 Change of temperature IEC 60068-2-30 Cyclic damp heat test <p>Vibration and shocks tested according to:</p> <ul style="list-style-type: none"> IEC 60068-2-27 Bumps IEC 60068-2-64 Vibration (broad-band random) IEC 60068-2-6 Vibration (sinusoidal)
CE	<p>Compliant with:</p> <ul style="list-style-type: none"> RE directive 2014/53/EU ROHS2 2011/65/EU directive with amendment 2015/863 REACH regulation
UKCA	<p>Compliant with:</p> <ul style="list-style-type: none"> Electromagnetic Compatibility Regulations 2016 The Restriction of the Use of Certain Hazardous Substances in Electrical and Electronic Equipment regulations 2012
FCC/IC	This product complies with the Part 15 of the FCC rules
Japan	This device complies with Japanese regulations
Other	RCM for Australia and New Zealand at product launch
Safety	<p>The product fulfils the requirements of:</p> <ul style="list-style-type: none"> EN IEC 62368-1:2020 + A11:2020 UL 62368-1 Third Edition CAN/CSA C22.2 No. 62368-1: 19 Third Edition



Figure 12. Other side sticker of the Ewon® Cosy+ WiFi - EC7133J

5.3. Ewon® Cosy+ 4G NA - EC7133K

- Order code: EC7133K_00MA
- Model number: 04102



Figure 13. Side sticker of the Ewon® Cosy+ 4G NA - EC7133K

5.3.1. Technical Specifications - EC7133K

Specifications	Details
WAN Connectivity	Ethernet or Cellular 4G
Bands	<ul style="list-style-type: none"> • 4G: B2, B4, B5, B12, B13, B14, B71 • 3G: B2, B5 • Automatic fallback to 3G
Antenna Connector	SMA female connector
Antenna	Not included in the delivery
WAN Ethernet	Up to 3 ports, 10/100 Mb Ethernet
LAN Ethernet	Up to 4 ports, 10/100 Mb Ethernet
Field Interface	Up to 10 USB 2.0 connections, female connector 2.0
SD Card Reader	YES, for Cosy commissioning (firmware upgrade, backup, Talk2m registration)
Mechanics	Dimensions: 108,80 x 99 x 43,60 mm (H x D x W). DIN rail or wall screw fixing system.
Weight	217 grams
Power Supply	12-24 VDC +/-20%, LPS
Extended Temperature Range	<ul style="list-style-type: none"> • Operating: -25°C to +60°C, 10 to 95% relative humidity (non condensing) • Storage: -30°C to +70°C, 10 to 95% relative humidity (non condensing)
Hardware	<ul style="list-style-type: none"> • 1xDO: open drain (MOSFET) 200 mA; isolation 1.5 kV • 2xDI: 0 to 24 VDC; 1.5 kV isolation
Marking	cULus, FCC
Warranty	36 months
Type Tests	<p>Temperature - Operating and Storage tested according to:</p> <ul style="list-style-type: none"> • IEC 60068-2-1 Cold test • IEC 60068-2-2 Dry heat test • IEC 60068-2-14 Change of temperature • IEC 60068-2-30 Cyclic damp heat test <p>Vibration and shocks tested according to:</p> <ul style="list-style-type: none"> • IEC 60068-2-27 Bumps • IEC 60068-2-64 Vibration (broad-band random) • IEC 60068-2-6 Vibration (sinusoidal)
FCC/IC	This product complies with the Part 15 of the FCC rules
Safety	<p>The product fulfils the requirements of:</p> <ul style="list-style-type: none"> • EN IEC 62368-1:2020 + A11:2020 • UL 62368-1 Third Edition • CAN/CSA C22.2 No. 62368-1: 19 Third Edition



NOTICE

Ewon® Cosy+ EC7133K modem is not compatible with Verizon and AT&T mobile networks.

5.4. Ewon® Cosy+ 4G EU - EC7133L

- Order code: EC7133L_00MA
- Model number: 04302

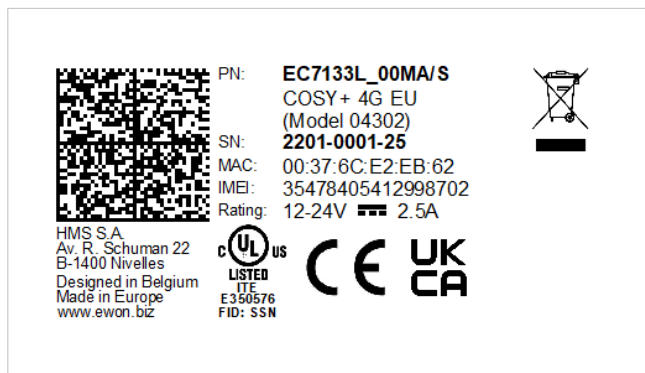

Figure 14. Side sticker of the Ewon® Cosy+ 4G EU - EC7133L

5.4.1. Technical Specifications - EC7133L

Specification	Details
WAN Connectivity	Ethernet or Cellular 4G
Bands	<ul style="list-style-type: none"> • 4G: B1, B3, B7, B8, B20, B28 • 3G: B1, B3, B8 • Automatic fallback to 3G
Antenna Connector	SMA female connector
Antenna	Not included in the delivery
WAN Ethernet	Up to 3 ports, 10/100 Mb Ethernet
LAN Ethernet	Up to 4 ports, 10/100 Mb Ethernet
Field Interface	Up to 10 USB 2.0 connections, female connector 2.0
SD Card Reader	YES, for Cosy commissioning (firmware upgrade, backup, Talk2m registration)
Mechanics	Dimensions: 108,80 x 99 x 43,60 mm (H x D x W). DIN rail or wall screw fixing system.
Weight	217 grams
Power Supply	12-24 VDC +/-20%, LPS
Extended Temperature Range	<ul style="list-style-type: none"> • Operating: -25°C to +60°C, 10 to 95% relative humidity (non condensing) • Storage: -30°C to +70°C, 10 to 95% relative humidity (non condensing)
Hardware	<ul style="list-style-type: none"> • 1xDO: open drain (MOSFET) 200 mA; isolation 1.5 kV • 2xDI: 0 to 24V DC; 1.5 kV isolation
Marking	CE, cULus, UKCA, RCM
Warranty	36 months
Type Tests	<p>Temperature - Operating and Storage tested according to:</p> <ul style="list-style-type: none"> • IEC 60068-2-1 Cold test • IEC 60068-2-2 Dry heat test • IEC 60068-2-14 Change of temperature • IEC 60068-2-30 Cyclic damp heat test <p>Vibration and shocks tested according to:</p> <ul style="list-style-type: none"> • IEC 60068-2-27 Bumps • IEC 60068-2-64 Vibration (broad-band random) • IEC 60068-2-6 Vibration (sinusoidal)
CE	<p>Compliant with:</p> <ul style="list-style-type: none"> • RE directive 2014/53/EU • ROHS2 2011/65/EU directive with amendment 2015/863 REACH regulation
UKCA	<p>Compliant with:</p> <ul style="list-style-type: none"> • Electromagnetic Compatibility Regulations 2016 • The Restriction of the Use of Certain Hazardous Substances in Electrical and Electronic Equipment Regulations 2012.
Other	RCM for Australia and New Zealand
Safety	<p>The product fulfils the requirements of:</p> <ul style="list-style-type: none"> • EN IEC 62368-1:2020 + A11:2020 • UL 62368-1 Third Edition • CAN/CSA C22.2 No. 62368-1: 19 Third Edition

5.5. Ewon® Cosy+ 4G APAC - EC7133M

- Order code: EC7133M_00MA
- Model number: 04402

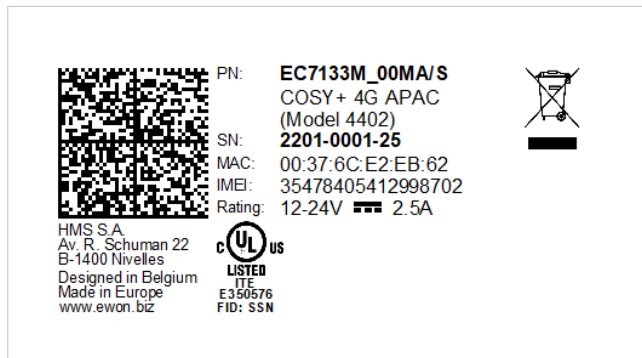

Figure 15. First side sticker of the Ewon® Cosy+ 4G APAC - EC7133M

5.5.1. Technical Specifications - EC7133M

Specifications	Details
WAN Connectivity	Ethernet or Cellular 4G
Bands	<ul style="list-style-type: none"> 4G: B1, B2, B3, B4, B5, B7, B8, B12, B13, B18, B19, B20, B25, B28, B38, B39, B40, B41. 3G: B1, B2, B4, B5, B6, B8, B19. Automatic fallback to 3G.
Antenna Connector	SMA female connector
Antenna	Not included in the delivery
WAN Ethernet	Up to 3 ports, 10/100 Mb Ethernet
LAN Ethernet	Up to 4 ports, 10/100 Mb Ethernet
Field Interface	Up to 10 USB 2.0 connections, female connector 2.0
SD Card Reader	YES, for Cosy commissioning (firmware upgrade, backup, Talk2m registration)
Mechanics	Dimensions: 108,80 x 99 x 43,60 mm (H x D x W). DIN rail or wall screw fixing system.
Weight	218 grams
Power Supply	12-24 VDC +/-20%, LPS
Extended Temperature Range	<ul style="list-style-type: none"> Operating: -25°C to +60°C, 10 to 95% relative humidity (noncondensing) Storage: -30°C to +70°C, 10 to 95% relative humidity (noncondensing)
Hardware	<ul style="list-style-type: none"> 1xDO: open drain (MOSFET) 200 mA; isolation 1.5 kV 2xDI: 0 to 24 VDC; 1.5 kV isolation
Marking	cULus, Japan, RCM
Warranty	36 months
Type Tests	<p>Temperature - Operating and Storage tested according to:</p> <ul style="list-style-type: none"> IEC 60068-2-1 Cold test IEC 60068-2-2 Dry heat test IEC 60068-2-14 Change of temperature IEC 60068-2-30 Cyclic damp heat test <p>Vibration and shocks tested according to:</p> <ul style="list-style-type: none"> IEC 60068-2-27 Bumps IEC 60068-2-64 Vibration (broad-band random) IEC 60068-2-6 Vibration (sinusoidal)
Japan	This device complies with Japanese regulations
Other	RCM for Australia and New Zealand
Safety	<p>The product fulfils the requirements of:</p> <ul style="list-style-type: none"> EN IEC 62368-1:2020 + A11:2020 UL 62368-1 Third Edition CAN/CSA C22.2 No. 62368-1: 19 Third Edition



Figure 16. Other side sticker of the Ewon® Cosy+ 4G APAC - EC7133M

6. IP Address and Access to the Web Configuration

6.1. Factory Default IP Settings

Table 7. Default IP address

Characteristics	Values
LAN IP address	10.0.0.53
LAN subnet mask	255.255.255.0
Gateway	0.0.0.0



NOTICE

The WAN IP address is set by default in DHCP mode.

6.2. Powering On

After powering on your Ewon® Cosy+, wait approximately 2 minutes for the boot process to complete.

You can observe one of the following behaviors:

1. The **USR** LED is slowly blinking green.
The boot process has completed successfully.
2. The **USR** LED is blinking red.
The boot process has failed. It was interrupted due to a problem. The blinking pattern defines the type of issue.

The most frequent problem is a duplicate IP address detected on the LAN network. The **USR** LED blinks red 1x short, 1x long, repeatedly.

For other error LED patterns, please refer to the General Reference Guide for Ewon® Cosy+ from the [Related Documents \(page 1\)](#) section.

6.3. Connecting to the LAN IP Address

Establish the first communication with the Ewon® Cosy+ by using its companion tool **eBuddy** which can be downloaded from www.ewon.biz/support.

Connect a LAN port (*port #1 is always set as a LAN port*) of the Ewon® Cosy+ to your computer either through a point-to-point connection or a network where there is no risk the Ewon® Cosy+'s default IP address (10.0.0.53) would conflict with another connected device.

6.4. Ewon® Cosy+ Web Interface

Methods to access the web panel of the Ewon® Cosy+:

1. While the computer is connected to a LAN port of the Ewon® Cosy+, open an Internet browser and go to the Ewon® Cosy+ web server. The **URL is the LAN IP address** of the Ewon® Cosy+.
2. You can also use **eBuddy** to access the web panel of the Ewon® Cosy+. To get started with **eBuddy** and access the Ewon® Cosy+, refer to the **eBuddy** document of the [Related Documents \(page 1\)](#) section.

Before beginning the configuration of the Ewon® Cosy+, an authentication is required.

**IMPORTANT**

Default login and password are both **adm**. For security reasons, the Ewon® Cosy+ will ask you to change the **adm** password.

Methods to configure your Ewon® Cosy+:**1. The Ecatcher Easy Setup (recommended)**

This method benefits from the *use of a USB stick or SD card* that holds a configuration file created inside **Ecatcher**.

More info in *Connect an Ewon device to Talk2m* from the [Related Documents \(page 1\)](#) section.

2. The Embedded Wizard Setup:

If your Ewon® Cosy+ hasn't been configured yet, a configuration wizard is suggested to set the basic settings of the Ewon® Cosy+ and to set up the connection to the Talk2m environment.

On our website, a [Quick Start Guide](#) will help you to start the configuration of your Ewon® Cosy+.

7. Troubleshooting

7.1. Standard Boot Process

The standard boot of an Ewon® Cosy+ takes approximately 2 minutes to complete.

During this process, all LEDs are first shortly on (except **BI1**), then only the **PWR** LED stays steady green.

As soon as the boot process is completed and the unit is ready to be used, the **USR** LED blinks green slowly to indicate the Ewon® Cosy+ is operational. Other LEDs might be steady green (if the device is connected to Internet, Talk2m...).

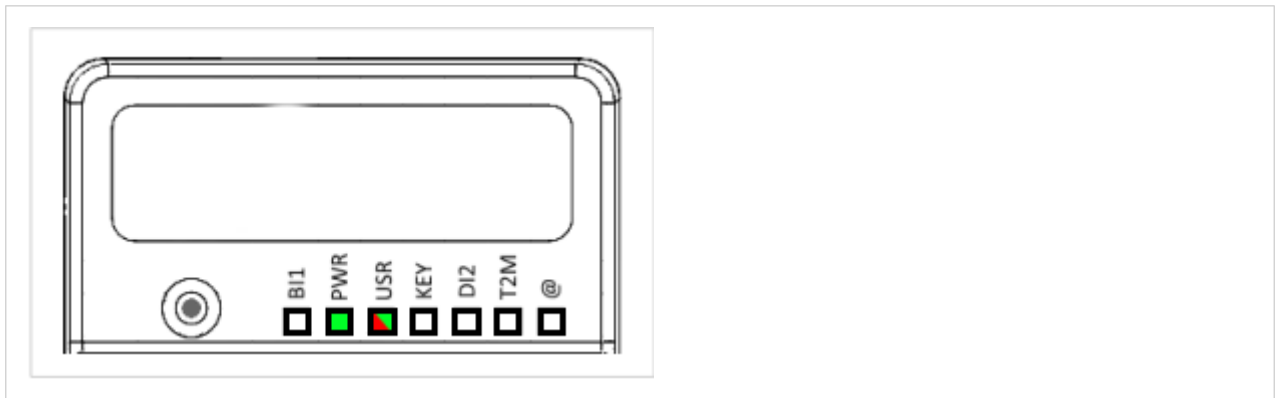

Figure 17. PWR is steady green while USR blinks green slowly

7.2. Reset of the Ewon® Cosy+

The reset button **BI1** is located on the front of the Ewon® Cosy+ (see [Front \(page 11\)](#) section).

The Ewon Cosy+ features two levels of reset: **User Reset** and **Factory Reset**.

7.2.1. First Reset Level: User Reset

The first level of reset is a selective reset that erases the user files part and the system settings. This type of reset does not alter the communication parameters of your Ewon® Cosy+.



NOTICE

Your Ewon® Cosy+ remains connected to Internet and Talk2m - if configured previously - even after a reset level 1.

Follow the below procedure to perform a reset level 1:

1. Power off the Ewon® Cosy+.
2. Press and maintain the reset button while powering on.
The **BI1** LED lights up (green color).
3. Keep the reset button pressed for 30 seconds approximately, until the **USR** LED blinks red 1x per second.
4. Release the reset button.

**IMPORTANT**

If you don't release the reset button when the **BI1** LED blinks red, you will trigger a reset level 2 which will format entirely your Ewon® Cosy+.

The **BI1** LED turns off.

5. Wait approximately 30 seconds for the reset level 1 to complete.
The Ewon® Cosy+ automatically restarts and the unit is ready to be used.

When the **USR** LED slowly blinks green (takes approximately 2 minutes), your Ewon® Cosy+ is operational.

7.2.2. Second Reset Level: Factory Reset

The second level reset restores the Ewon® Cosy+ to its factory settings.

This operation consists in 3 steps:

1. Format the entire non volatile memory, including all COM parameters and IP addresses.
2. Full hardware auto-test with result shown by the **USR** LED.
3. Return to ex-factory configuration (default configuration).

Follow the below procedure to perform a reset level 2:

1. Press and maintain the reset button while powering on.
The **BI1** LED lights up (green color).
2. Keep the reset button pressed for approximately 35 seconds until the **USR** LED is no longer blinking red but goes to steady red.
3. Release the reset button.
The **BI1** LED turns off.
 - The **USR** LED quickly blinks green: the Ewon® Cosy+ is processing the reset request.
 - The **USR** LED blinks red with the following pattern: 500ms ON, 500ms OFF. This pattern indicates that your Ewon® Cosy+ is ready for reboot.
 - Any other pattern indicates an error
 - The Ewon® Cosy+ **does NOT restart** by itself in normal mode and remains running in this diagnostic mode.
4. Power off & on the Ewon® Cosy+ to reboot it in a normal mode.
The Ewon® Cosy+ returns to its default COM parameters and factory IP addresses (such as LAN 10.0.0.53) after this level 2 reset is performed.

**NOTICE**

If an error pattern occurs on the **USR** LED, please check out the troubleshooting page:
www.ewon.biz/support

7.2.3. Reset Matrix

Table 8. Impact matrix of a reset

Reset Level	Erased or Reset	Preserved
Impact of a reset level 1: User reset	Ewon® Cosy+ identification	LAN IP address + mask
	Custom user web site	Internet access
	Talk2m configuration	User Password
		Language settings
		Modem / Wi-Fi settings
		Talk2m configuration
		Proxy configuration
		LAN switch configuration
	Gateway (USB, NAT 1:1)	
Impact of a reset level 2: Factory reset	<p>The Ewon® Cosy+ will be reset to a factory settings configuration.</p> <p>All parameters will be lost except the VPN configuration.</p> <p>The Reset Level 2 does not delete the VPN link with the Talk2m account. If you enable the VPN connection manually, your Ewon device will be able to reconnect its Talk2m account in the VPN.</p>	



NOTE

After a reset level 1, gateway (USB, NAT 1:1) configurations remain even if the Wizards indicates otherwise on the Ewon Web Interface.

Appendix A. Appendix

1. Main Connector

As shown in the image below, the **female mating connector** is labelled with the appropriate symbols.

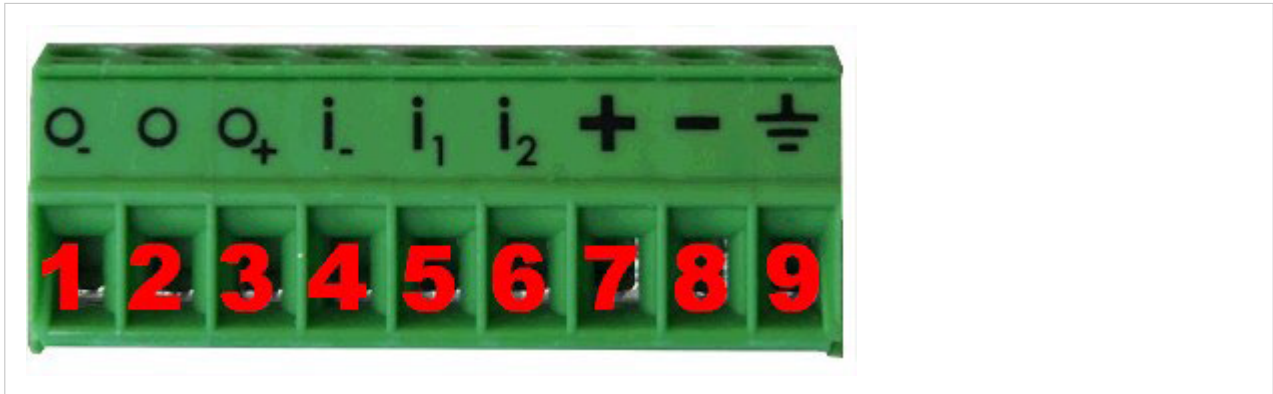

Figure A.1. The Ewon® Cosy+ Female connector

Table A.1. Labels on main connector

PIN	Icon	ID	Description
1	O	DO_COM	Output signal (0V ground) connected to the emitter of the MOSFET transistor
2	O	DO	Output signal connected to the drain of the MOSFET transistor
3	O ₊	DO_VDC	Common of the external predrive power supply (between +12 and +24 VDC)
4	I ₋	DI_COM	Ground of the input (isolated)
5	I ₁	DI1	Input signal 1
6	I ₂	DI2	Input signal 2
7	+	Power in VDD+	Between +12 and +24Vdc
8	-	Power in GND-	0V
9		Functional earth	

Table A.2. Characteristic of main connector

Characteristic	Value
Connector type	MINICONNEC MC model Type MC 1.5 / 9-ST-3.5 Pitch = 3.50mm 9-pin female
Maximal tightening torque	0.25Nm In the absence of a torque wrench, a soft manual tightening is sufficient.

2. Specification of the External Power Supply

The Ewon® Cosy+ should be supplied from an external, separately provided, power supply 12-24Vdc, 30W min. certified for 60°C and for altitude up to 2000m.

Power supply should be separately certified according to UL/IEC 62368-1 with ES1, PS2 output or separately certified to IEC/UL60950-1 with LPS output or Class2 per NEC.

Table A.3. Characteristics of the power supply

Characteristic	Value
Power supply voltage	External 12-24Vdc +/- 19%
Maximum Ewon® Cosy+ input power	30W maximum
Internal voltage protection	30V maximum
Input protection	Protected against polarity inversion

3. Digital Output & Digital Inputs

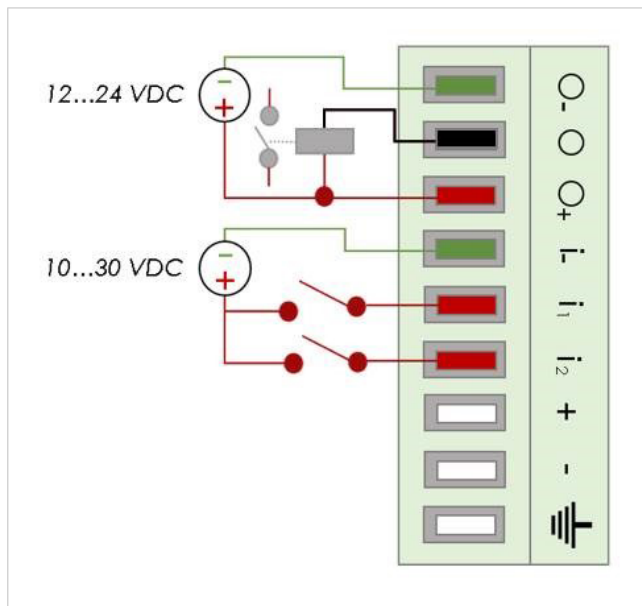

Figure A.2. Current scheme of the main connector

Table A.4. Main connector characteristics

Characteristic	Value
Type of digital output ^a	Open drain MOSFET
Maximum current (external source)	200 mA
Isolation (both DI & DO)	1.5 kV
DI voltage range	0 to 24 VDC
DI protection	33 VDC maximum
DI OFF state - Input voltage range	0 to 5 VDC
DI ON state - Input voltage range	10 to 30 VDC
DI ON state - Current range	from 3,8 mA @ 12 VDC to 8,2 mA @ 24 VDC

^aDuring the starting boot process, the DO is set to ON for a short time (2 seconds).

The Digital Output is activated by an open drain MOSFET transistor driven by an optocoupler. The maximum current flow inside this transistor has a value above the one specified in the Ewon® Cosy+, in order to cope with the switching power losses.

The transistor used is in an open drain type with predrive. This means the relay power supply has to be supplied from an external source to the predrive electronics.

The diagram below shows the external wiring needed for proper operation of the digital output. A relay has been chosen for this sample application but any load within the specifications can be used instead.



NOTICE

This is a sink output to ground. The transistor acts as a switch ground.

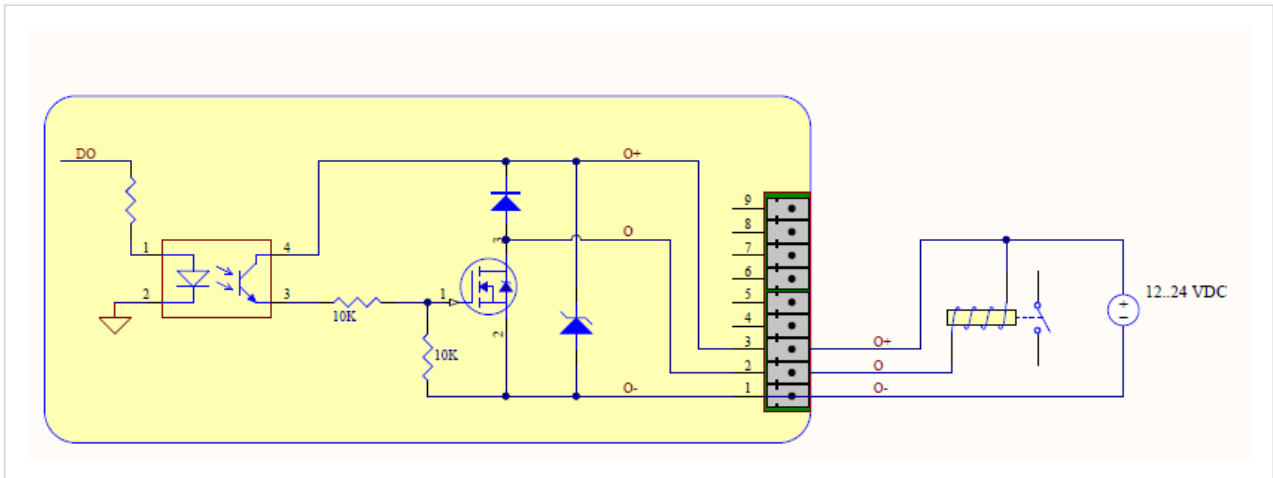

Figure A.3. External wiring of the Digital Output

3.1. Possible Features of the DI & DO

Wiring the Digital Input and Digital Output allows you to externalize some features (as connectivity condition), as described below:

Table A.5. Features linked to DO & DI

LED	Connector	Description
KEY	DI1	Authorize or prevent the Internet connection
		Authorize or prevent the VPN connection
		Trigger an SMS or email notification
DI2	DI2	Trigger an SMS or email notification
T2M	DO ^a	Can be wired to an external device to propagate the Talk2m status. The DO is set to 1 when there is an active remote connection (= remote user connected). Summary of the DO status based on Talk2m connectivity: <ul style="list-style-type: none"> • T2M LED off → DO off There is no VPN tunnel established. • T2M LED steady → DO off The VPN tunnel is established but there is no active remote connection (no remote user connected through Talk2m). • T2M LED blinking → DO on The VPN tunnel is established and there is an active remote connection (a remote user is connected through Talk2m).

^aDuring the starting boot process, the DO is set to ON for a short time (2 seconds).

The configuration of these conditions is done as part of the **DI Config** wizard.