

Green-Mode Power Switch

GF001H

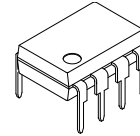

PDIP8 9.59x6.6, 2.54P
CASE 646CN

Description

The GF001H is a next-generation, Green-Mode Power Switch. It integrates an advanced current-mode Pulse Width Modulator (PWM) and an avalanche-rugged 700 V SENSEFET® in a single package, allowing auxiliary power designs with higher standby energy efficiency, reduced size, improved reliability, and lower system cost than previous solutions.

A new frequency modulation reduces EMI emission and built-in synchronized slope compensation allows stable peak-current-mode control over a wide range of input voltage.

Requiring a minimum number of external components, the GF001H provides a solid platform for cost-effective flyback converter design with low standby power consumption.

Features

- Advanced Burst Mode Operation at No-Load Condition
- 700 V High-Voltage JFET Startup Circuit
- Internal Avalanche-Rugged 700 V SENSEFET
- Built-in 5 ms Soft-Start
- Peak-Current-Mode Control
- Cycle-by-Cycle Current Limiting
- Leading-Edge Blanking (LEB)
- Synchronized Slope Compensation
- Frequency Modulation to Attenuating EMI
- Internal Overload / Open-Loop Protection (OLP)
- V_{DD} Under-Voltage Lockout (UVLO)
- V_{DD} Over-Voltage Protection (OVP)
- Internal Auto-Restart Circuit (OLP, VDD OVP)
- Adjustable Peak Current Limit
- This Device is Pb-Free, Halide Free and are RoHS Compliant

MARKING DIAGRAM

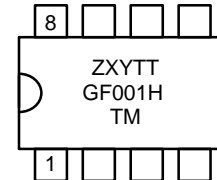

- Z = Plant Code
- X = 1-Digit Year Code
- Y = 1-Digit Week Code
- TT = 2-Digit Die Run Code
- T = Package Type (N: DIP)
- M = Manufacture Flow Code
- GF001H = Device Code

ORDERING INFORMATION

See detailed ordering and shipping information on page 11 of this data sheet.

GF001H

APPLICATION DIAGRAM

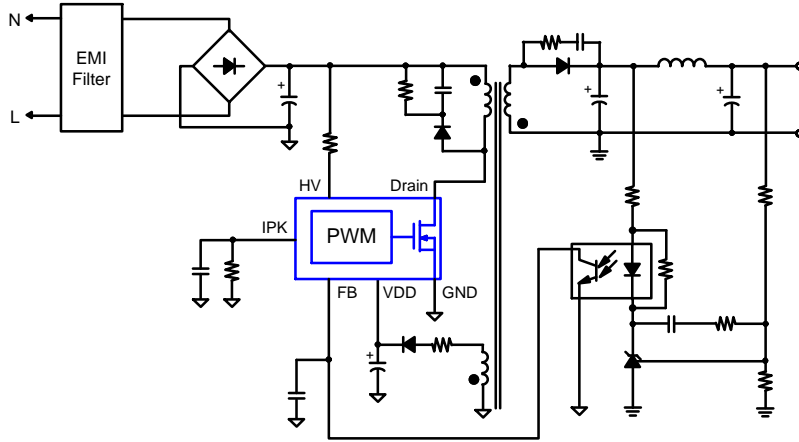

Figure 1. Typical Flyback Application

OUTPUT POWER TABLE (Note 1)

Product	230 V _{AC} ±15% (Note 2)		85 – 265 V _{AC}	
	Adapter (Note 3)	Open-Frame (Note 4)	Adapter (Note 3)	Open-Frame (Note 4)
GF001HN	14 W	20 W	11 W	16 W

1. The maximum output power can be limited by junction temperature.
2. 230 V_{AC} or 100/115 V_{AC} with voltage doublers.
3. Typical continuous power in a non-ventilated enclosed adapter, with sufficient drain pattern of printed circuit board (PCB) as a heat sink, at 50°C ambient.
4. Maximum practical continuous power in an open-frame, design with sufficient drain pattern of printed circuit board (PCB) as a heat sink, at 50°C ambient.

BLOCK DIAGRAM

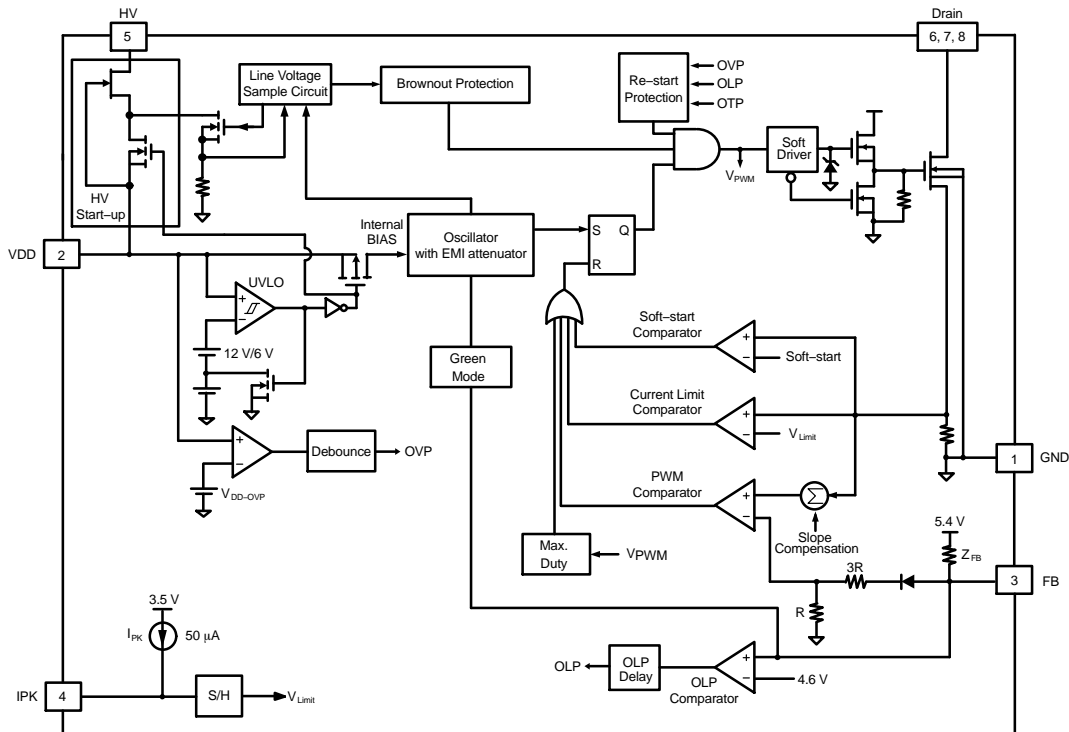

Figure 2. Internal Block Diagram

GF001H

PIN CONFIGURATION

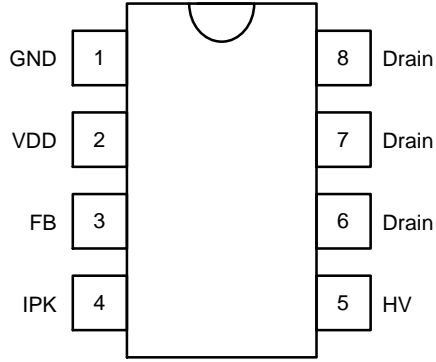

Figure 3. Pin Assignment

PIN DEFINITIONS

Pin #	Name	Description
1	GND	<i>Ground.</i> This pin internally connects to the SENSEFET source and signal ground of the PWM controller.
2	VDD	<i>Supply Voltage of the IC.</i> Typically the hold-up capacitor connects from this pin to ground. A rectifier diode in series with the transformer auxiliary winding connects to this pin to supply bias during normal operation.
3	FB	<i>Feedback.</i> The signal from the external compensation circuit connects to this pin. The PWM duty cycle is determined by comparing the signal on this pin and the internal current-sense signal.
4	IPK	<i>Adjust Peak Current.</i> Typically a resistor connects from this pin to the GND pin to program the current-limit level. The internal current source (50 μ A) introduces voltage drop across the resistor, which determines the current-limit level of pulse-by-pulse current limit.
5	HV	<i>Startup.</i> Typically, resistors in series from DC line connect to this pin to supply internal bias and to charge the external capacitor connected between the VDD pin and the GND pin during startup. This pin is also used to sense the line voltage for brownout protection.
6	Drain	<i>SENSEFET Drain.</i> This pin is designed to directly drive the transformer.
7		
8		

GF001H

ABSOLUTE MAXIMUM RATINGS

Symbol	Parameter	Min	Max	Unit
V _{DRAIN}	Drain Pin Voltage (Note 5, 6)	–	700	V
I _{DM}	Drain Current Pulsed (Note 7)	–	8.0	A
E _{AS}	Single Pulsed Avalanche Energy (Note 8)	–	140	mJ
V _{DD}	DC Supply Voltage	–	25	V
V _{FB}	FB Pin Input Voltage	–0.3	6.0	V
V _{IPK}	IPK Pin Input Voltage	–0.3	6.0	V
V _{HV}	HV Pin Input Voltage	–	700	V
P _D	Power Dissipation (T _A < 50°C)	–	1.5	W
T _J	Operating Junction Temperature	–40	Internally Limited (Note 9)	°C
T _{STG}	Storage Temperature Range	–55	+150	°C
T _L	Lead Soldering Temperature (Wave Soldering or IR, 10 Seconds)	–	+260	°C

Stresses exceeding those listed in the Maximum Ratings table may damage the device. If any of these limits are exceeded, device functionality should not be assumed, damage may occur and reliability may be affected.

5. All voltage values, except differential voltages, are given with respect to the network ground terminal.

6. Stresses beyond those listed under Absolute Maximum Ratings may cause permanent damage to the device.

7. Non-repetitive rating: pulse width is limited by the maximum junction temperature.

8. L = 51 mH, starting T_J = 25°C.

9. Internally limited by Over-Temperature Protection (OTP). Refer to T_{OTP}.

THERMAL RESISTANCE TABLE

Symbol	Parameter	Value	Unit
θ _{JA}	Junction-to-Air Thermal Resistance	86	°C/W
Ψ _{JT}	Junction-to-Package Thermal Resistance (Note 10)	20	°C/W

10. Measured on the package top surface.

ESD CAPABILITY

Symbol	Parameter	Value	Unit
ESD	Human Body Model, JESD22–A114 (Note 11)	All Pins Excluding HV Pin	7
		All Pins Including HV Pin	3
	Charged Device Model, JESD22–C101 (Note 11)	All Pins Excluding HV Pin	2
		All Pins Including HV Pin	2

11. Meets JEDEC standards JESD 22–A114 and JESD 22–C101.

GF001H

ELECTRICAL CHARACTERISTICS ($V_{DD} = 15\text{ V}$, and $T_A = 25^\circ\text{C}$ unless otherwise specified.)

Symbol	Parameter	Condition	Min	Typ	Max	Unit
SENSEFET SECTION (Note 12)						
BV_{DSS}	Drain–Source Breakdown Voltage	$V_{DS} = 700\text{ V}$, $V_{GS} = 0\text{ V}$	700	–	–	V
I_{DSS}	Zero–Gate–Voltage Drain Current	$V_{DS} = 700\text{ V}$, $V_{GS} = 0\text{ V}$	–	–	50	μA
		$V_{DS} = 560\text{ V}$, $V_{GS} = 0\text{ V}$, $T_C = 125^\circ\text{C}$	–	–	200	
$R_{DS(ON)}$	Drain–Source On–State Resistance (Note 12)	$V_{GS} = 10\text{ V}$, $I_D = 0.5\text{ A}$	–	6.0	7.2	Ω
C_{ISS}	Input Capacitance	$V_{GS} = 0\text{ V}$, $V_{DS} = 25\text{ V}$, $f = 1\text{ MHz}$	–	550	715	pF
C_{OSS}	Output Capacitance	$V_{GS} = 0\text{ V}$, $V_{DS} = 25\text{ V}$, $f = 1\text{ MHz}$	–	38	50	pF
C_{RSS}	Reverse Transfer Capacitance	$V_{GS} = 0\text{ V}$, $V_{DS} = 25\text{ V}$, $f = 1\text{ MHz}$	–	17	26	pF
$t_{d(on)}$	Turn–On Delay	$V_{DS} = 350\text{ V}$, $I_D = 1.0\text{ A}$	–	20	50	ns
t_r	Rise Time	$V_{DS} = 350\text{ V}$, $I_D = 1.0\text{ A}$	–	15	40	ns
$t_{d(off)}$	Turn–Off Delay	$V_{DS} = 350\text{ V}$, $I_D = 1.0\text{ A}$	–	55	120	ns
t_f	Fall Time	$V_{DS} = 350\text{ V}$, $I_D = 1.0\text{ A}$	–	25	60	ns

CONTROL SECTION

VDD SECTION

V_{DD-ON}	UVLO Start Threshold Voltage		11	12	13	V
$V_{DD-OFF1}$	UVLO Stop Threshold Voltage		5	6	7	V
$V_{DD-OFF2}$	I_{DD-OLP} Enable Threshold Voltage		8	9	10	V
V_{DD-OLP}	V_{DD} Voltage Threshold for HV Startup Turn–On at Protection Mode		5	6	7	V
I_{DD-ST}	Startup Supply Current	$V_{DD-ON} - 0.16\text{ V}$	–	–	30	μA
I_{DD-OP1}	Operating Supply Current with Normal Switching Operation	$V_{DD} = 15\text{ V}$, $V_{FB} = 3\text{ V}$	–	–	3.8	mA
I_{DD-OP2}	Operating Supply Current without Switching Operation	$V_{DD} = 15\text{ V}$, $V_{FB} = 1\text{ V}$	–	–	1.8	mA
I_{DD-OLP}	Internal Sinking Current	$V_{DD-OLP} + 0.1\text{ V}$	40	60	100	μA
V_{DD-OVP}	V_{DD} Over–Voltage Protection		23	24	25	V
$t_{D-VDDOVP}$	V_{DD} Over–Voltage Protection Debounce Time		40	105	170	μs

HV SECTION

I_{HV}	Supply Current Drawn from HV Pin	HV = 120 V_{DC} , $V_{DD} = 0\text{ V}$ with 10 μF	1.2	–	4.7	mA
V_{HV}	Minimum HV Voltage for V_{DD} being charged to V_{DD-ON}	$R_{HV} = 0\ \Omega$, $T_A = -40^\circ\text{C}$ to 105°C	30	–	–	V
I_{HV-LC}	Leakage Current after Startup	HV = 700 V, $V_{DD} = V_{DD-OFF1} + 1\text{ V}$	–	–	10	μA
V_{DC-ON}	Brown–in Threshold Level (V_{DC})	DC Voltage Applied to HV Pin Through 200 $k\Omega$ Resistor	104	114	124	V
V_{DC-OFF}	Brownout Threshold Level (V_{DC})		89	99	109	V
t_{UVP}	Brownout Protection Time		0.8	1.2	1.6	s

OSCILLATOR SECTION

f_{OSC}	Frequency in Nominal Mode	Center Frequency	94	100	106	kHz
f_M	Frequency Modulation		–	± 6	–	kHz
f_{OSC-G}	Green–Mode Frequency		20	23	26	kHz
f_{DV}	Frequency Variation vs. V_{DD} Deviation	$V_{DD} = 11\text{ V}$ to 22 V	–	–	5	%
f_{DT}	Frequency Variation vs. Temperature Deviation (Note 12)	$T_A = -40^\circ\text{C}$ to 105°C	–	–	5	%

GF001H

ELECTRICAL CHARACTERISTICS ($V_{DD} = 15\text{ V}$, and $T_A = 25^\circ\text{C}$ unless otherwise specified.) (continued)

Symbol	Parameter	Condition	Min	Typ	Max	Unit
FEEDBACK INPUT SECTION						
A_V	Internal Voltage Dividing Factor of FB Pin (Note 12)		1/4.5	1/4.0	1/3.5	V/V
Z_{FB}	Pull-Up Impedance of FB Pin		15	21	27	k Ω
$V_{FB-OPEN}$	FB Pin Pull-Up Voltage	FB Pin Open	5.2	5.4	5.6	V
V_{FB-OLP}	FB Voltage Threshold to Trigger Open-Loop Protection		4.3	4.6	4.9	V
t_{D-OLP}	Delay of FB Pin Open-Loop Protection		46	56	66	ms
V_{FB-N}	FB Voltage Threshold to Exit Green Mode	V_{FB} is Rising	2.4	2.6	2.8	V
V_{FB-G}	FB Voltage Threshold to Enter Green Mode	V_{FB} is Falling	–	$V_{FB-N} - 0.2$	–	V
V_{FB-ZDC}	FB Voltage Threshold to Enter Zero-Duty State	V_{FB} is Falling	1.1	1.2	1.3	V
$V_{FB-ZDCR}$	FB Voltage Threshold to Exit Zero-Duty State	V_{FB} is Rising	–	$V_{FB-ZDC} + 0.1$	–	V

IPK PIN SECTION

$V_{IPK-OPEN}$	IPK Pin Open Voltage		3.0	3.5	4.0	V
V_{IPK-H}	Internal Upper Clamping Voltage of IPK Pin (Note 12)		–	–	3	V
V_{IPK-L}	Internal Lower Clamping Voltage of IPK Pin (Note 12)		1.5	–	–	V
I_{PK}	Internal Current Source of IPK Pin	$T_A = -40^\circ\text{C}$ to 105°C , $V_{IPK} = 2.25\text{ V}$	45	50	55	μA
I_{LMT-H}	Flat Threshold Level of Current Limit for the Highest IPK Level	$V_{IPK} = 3\text{ V}$	0.90	1.00	1.10	A
I_{LMT-L}	Flat Threshold Level of Current Limit for the Lowest IPK Level	$V_{IPK} = 1.5\text{ V}$	0.45	0.50	0.55	A

CURRENT-SENSE SECTION (Note 13)

t_{PD}	Current Limit Turn-Off Delay (Note 14)		–	100	200	ns
t_{LEB}	Leading-Edge Blanking Time (Note 14)		160	210	260	ns
t_{SS}	Soft-Start Time (Note 12)		–	5	–	ms

GATE SECTION (Note 13)

DCY_{MAX}	Maximum Duty Cycle		70	–	–	%
-------------	--------------------	--	----	---	---	---

OVER TEMPERATURE PROTECTION SECTION (OTP)

T_{OTP}	Junction Temperature to Trigger OTP (Note 12)		140	–	–	$^\circ\text{C}$
-----------	---	--	-----	---	---	------------------

Product parametric performance is indicated in the Electrical Characteristics for the listed test conditions, unless otherwise noted. Product performance may not be indicated by the Electrical Characteristics if operated under different conditions.

12. Guaranteed by design; not 100% tested in production.

13. Pulse test: pulse width $\leq 300\ \mu\text{s}$, duty $\leq 2\%$.

14. These parameters, although guaranteed, are tested in wafer-sort process.

GF001H

TYPICAL CHARACTERISTICS

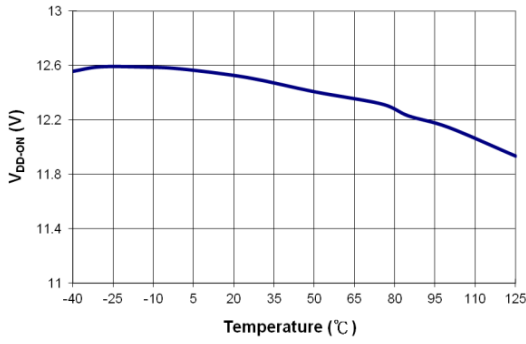

Figure 4. V_{DD-ON} vs. Temperature

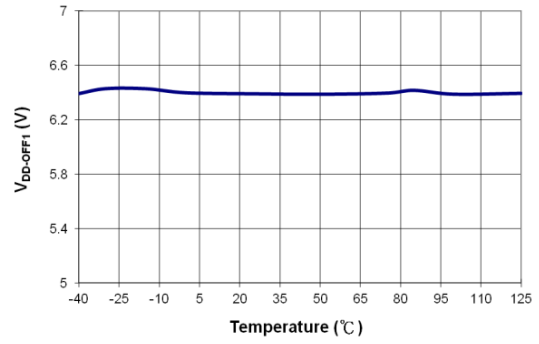

Figure 5. $V_{DD-OFF1}$ vs. Temperature

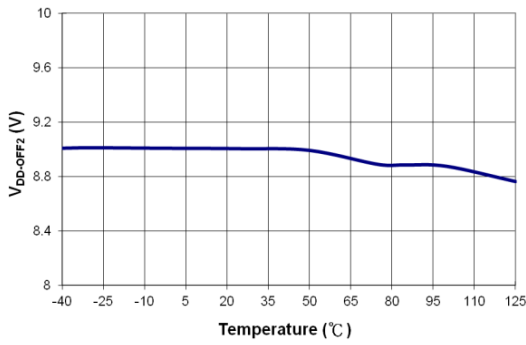

Figure 6. $V_{DD-OFF2}$ vs. Temperature

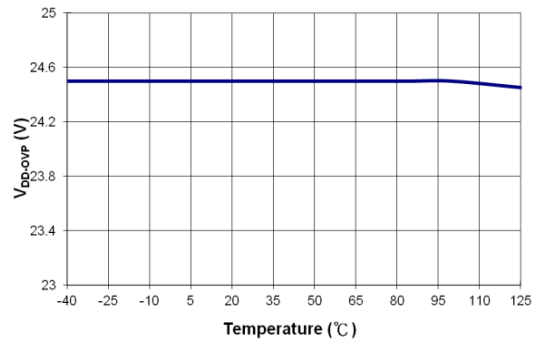

Figure 7. V_{DD-OVP} vs. Temperature

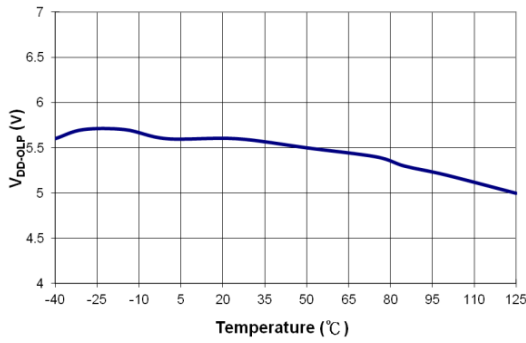

Figure 8. V_{DD-OLP} vs. Temperature

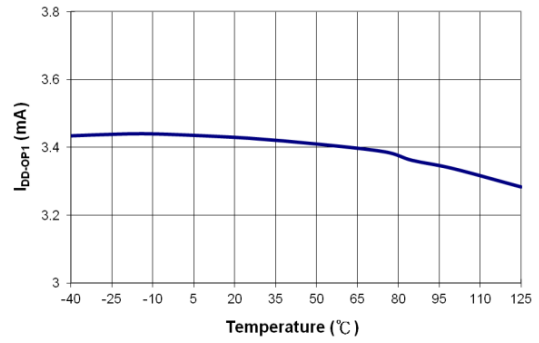

Figure 9. I_{DD-OP1} vs. Temperature

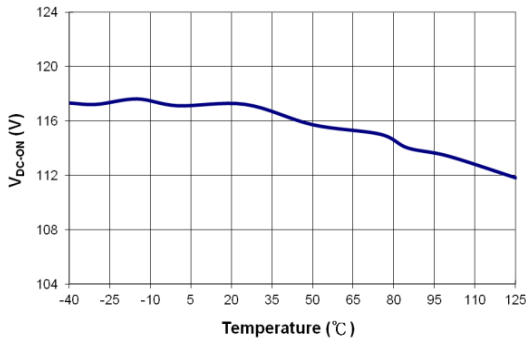

Figure 10. V_{DC-ON} vs. Temperature

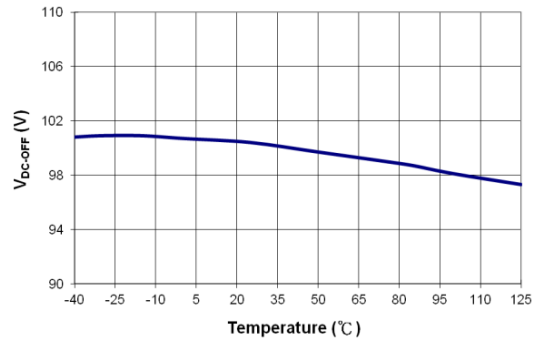

Figure 11. V_{DC-OFF} vs. Temperature

TYPICAL CHARACTERISTICS (Continued)

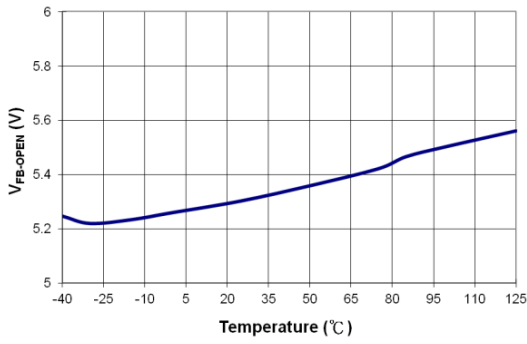

Figure 12. V_{FB-OPEN} vs. Temperature

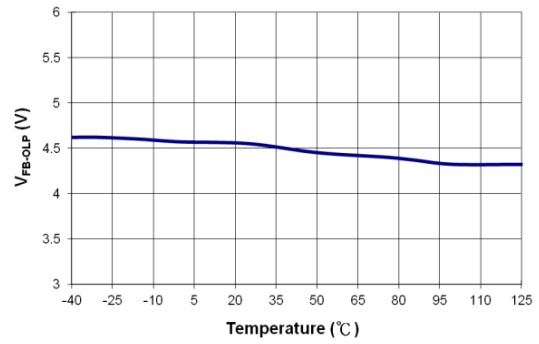

Figure 13. V_{FB-OLP} vs. Temperature

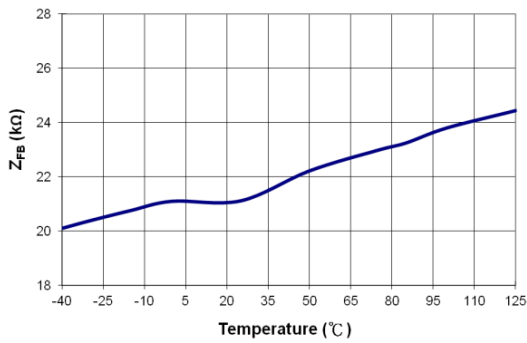

Figure 14. Z_{FB} vs. Temperature

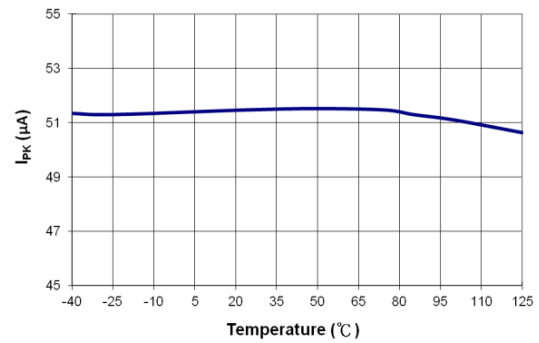

Figure 15. I_{PK} vs. Temperature

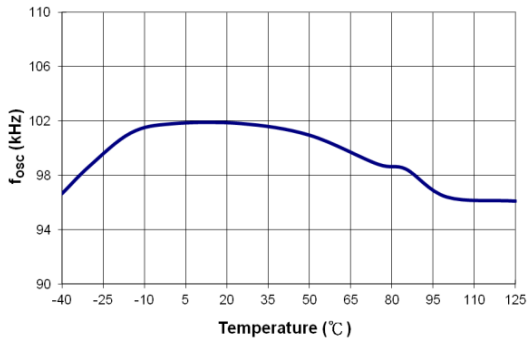

Figure 16. f_{OSC} vs. Temperature

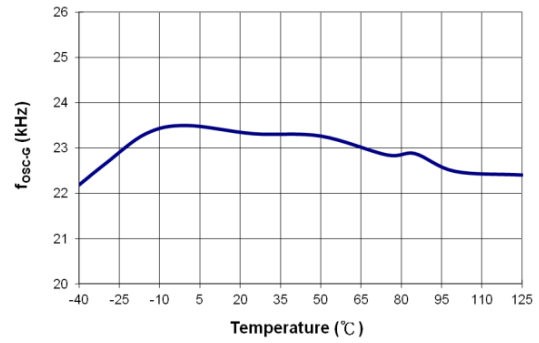

Figure 17. f_{OSC-G} vs. Temperature

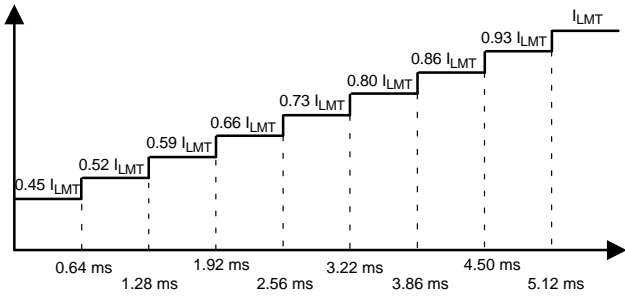

Figure 21. Current Limit Variation During Soft-Start

Adjustable Peak Current Limit

The peak current limit is programmable using a resistor on the IPK pin. The internal current 50 μ A source for the IPK pin generates voltage drop across the resistor. The voltage of the IPK pin determines the current-limit level. Since the upper and lower clamping voltage of the IPK pin are 3 V and 1.5 V, respectively; the suggested resistor value is from 30 k Ω to 60 k Ω .

Green Mode

As output load condition is reduced, the switching loss becomes the largest power loss factor. GF001H uses the FB pin voltage to monitor output load condition. As output load decreases, V_{FB} decreases and switching frequency declines, show in Figure 22. Once V_{FB} falls to 2.4 V, the switching frequency varies between 21.5 kHz and 24.5 kHz before Burst Mode operation. At Burst Mode operation, random frequency fluctuation still functions.

As V_{FB} falls below V_{FB-ZDC} , the GF001H enters Burst Mode, where PWM switching is disabled. The output voltage starts to drop, causing the feedback voltage to rise. Once V_{FB} rises above $V_{FB-ZDCR}$, switching resumes. Burst Mode alternately enables and disables switching, thereby reducing switching loss to reduce power consumption, shown in Figure 23.

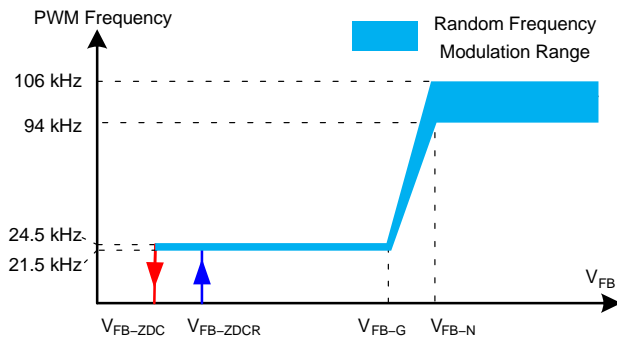

Figure 22. PWM Frequency

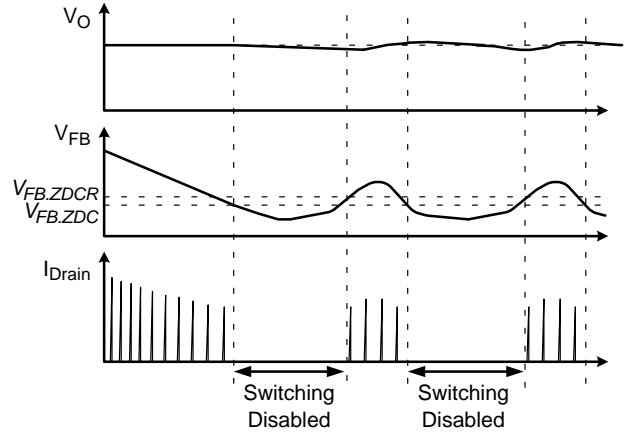

Figure 23. Burst-Mode Operation

Protections

The GF001H provides protection functions that include Overload / Open-Loop Protection (OLP) and Over-Voltage Protection (OVP). All the protections are implemented as Auto-Restart Mode. Once the fault condition is detected, switching is terminated and the SENSEFET remains off, this causes V_{DD} to fall. When V_{DD} falls to 6 V, the protection is reset and HV startup circuit charges V_{DD} up to 12 V voltage, allowing restart.

Open-Loop / Overload Protection (OLP)

Because of the pulse-by-pulse current-limit capability, the maximum peak current through the SENSEFET is limited and maximum input power is limited. If the output consumes more than the limited maximum power, the output voltage (V_O) drops below the set voltage. The current through the opto-coupler LED and the transistor become virtually zero and FB voltage is pulled HIGH, shown in Figure 24. If feedback voltage is above 4.6 V for longer than 56 ms, OLP is triggered. This protection is also triggered when the feedback loop is open due to a soldering defect.

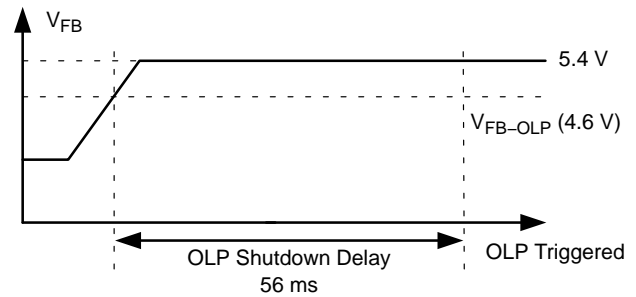

Figure 24. OLP Operation

GF001H

V_{DD} Over-Voltage Protection (OVP)

If the secondary-side feedback circuit malfunctions or a solder defect causes an opening in the feedback path, the current through the opto-coupler transistor becomes virtually zero. Feedback voltage climbs in a similar manner to the overload situation, forcing the preset maximum current to be supplied to the SMPS until the overload protection triggers. Since more energy than required is provided to the output, the output voltage may exceed the rated voltage before the overload protection triggers, resulting in the breakdown of the devices in the secondary side. To prevent this situation, an OVP circuit is employed. Since V_{DD} voltage is proportional to the output voltage by the transformer coupling, the over-voltage of output is indirectly detected using V_{DD} voltage. The OVP is triggered when V_{DD} voltage reaches 24 V. Debounce time (typically 105 μs) is applied to prevent false triggering by switching noise.

Two-Level UVLO

Since all the protections of the GF001H are auto-restart, the power supply repeats shutdown and restart until the fault condition is removed. GF001H has two-level UVLO, which is enabled when protection is triggered, to delay the re-startup by slowing down the discharge of V_{DD}. This effectively reduces the input power of the power supply during the fault condition, minimizing the voltage/current stress of the switching devices. Figure 25 shows the normal UVLO operation and two-step UVLO operation. When V_{DD} drops to 6 V without triggering the protection, PWM stops switching and V_{DD} is charged up by the HV startup circuit. Meanwhile, when the protection is triggered, GF001H has a different V_{DD} discharge profile. Once the protection is triggered, the IC stops switching and V_{DD}

drops. When V_{DD} drops to 9 V, the operating current becomes very small and V_{DD} is slowly discharged. When V_{DD} is naturally discharged down to 6 V, the protection is reset and V_{DD} is charged up by the HV startup circuit. Once V_{DD} reaches 12 V, the IC resumes switching operation.

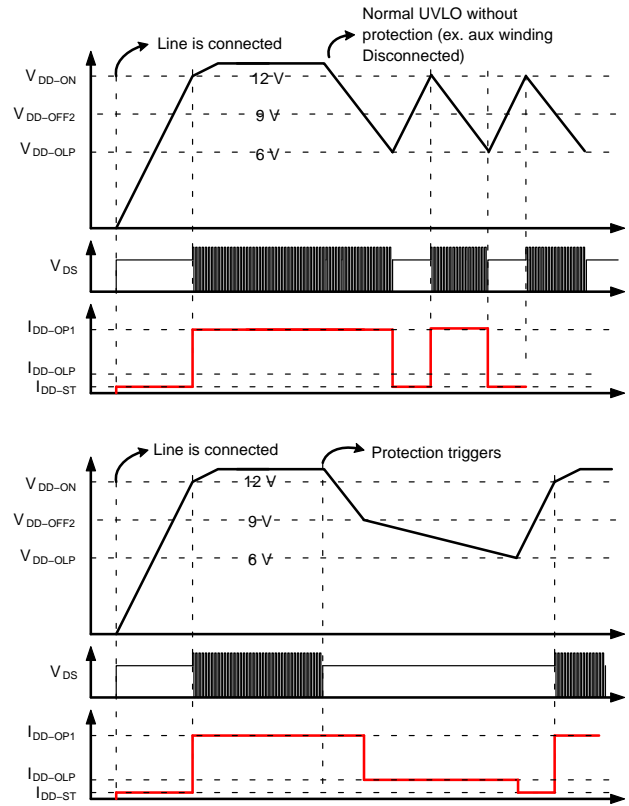

Figure 25. Two-Level UVLO

ORDERING INFORMATION

Part Number	SENSEFET	Operating Temperature Range	Package	Shipping
GF001HN	2 A 700 V	-40°C to +105°C	8-Pin, Dual Inline Package (DIP) (Pb-Free, Halide Free)	3000 Units / Tube

SENSEFET is registered trademarks of Semiconductor Components Industries, LLC dba "onsemi" or its affiliates and/or subsidiaries in the United States and/or other countries.

MECHANICAL CASE OUTLINE
PACKAGE DIMENSIONS

PDIP8 9.59x6.6, 2.54P
CASE 646CN
ISSUE O

DATE 31 JUL 2016

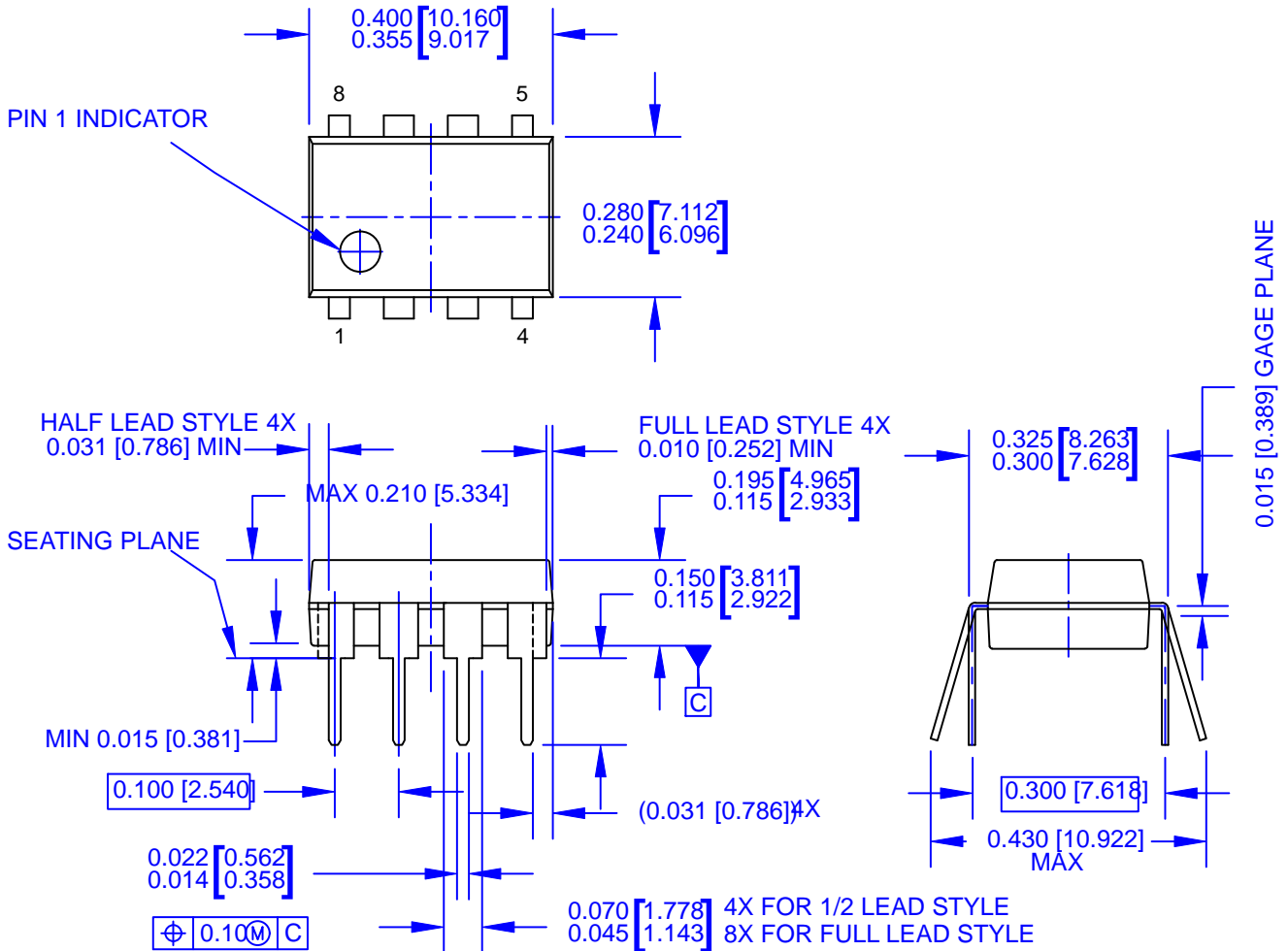

NOTES:

- A) THIS PACKAGE CONFORMS TO JEDEC MS-001 VARIATION BA WHICH DEFINES 2 VERSIONS OF THE PACKAGE TERMINAL STYLE WHICH ARE SHOWN HERE.
- B) CONTROLLING DIMS ARE IN INCHES
- C) DIMENSIONS ARE EXCLUSIVE OF BURRS, MOLD FLASH, AND TIE BAR EXTRUSIONS.
- D) DIMENSIONS AND TOLERANCES PER ASME Y14.5M-2009

DOCUMENT NUMBER:	98AON13470G	Electronic versions are uncontrolled except when accessed directly from the Document Repository. Printed versions are uncontrolled except when stamped "CONTROLLED COPY" in red.
STATUS:	ON SEMICONDUCTOR STANDARD	
NEW STANDARD:		
DESCRIPTION:	PDIP8 9.59X6.6, 2.54P	PAGE 1 OF 2

onsemi, **Onsemi**, and other names, marks, and brands are registered and/or common law trademarks of Semiconductor Components Industries, LLC dba "**onsemi**" or its affiliates and/or subsidiaries in the United States and/or other countries. **onsemi** owns the rights to a number of patents, trademarks, copyrights, trade secrets, and other intellectual property. A listing of **onsemi**'s product/patent coverage may be accessed at www.onsemi.com/site/pdf/Patent-Marking.pdf. **onsemi** reserves the right to make changes at any time to any products or information herein, without notice. The information herein is provided "as-is" and **onsemi** makes no warranty, representation or guarantee regarding the accuracy of the information, product features, availability, functionality, or suitability of its products for any particular purpose, nor does **onsemi** assume any liability arising out of the application or use of any product or circuit, and specifically disclaims any and all liability, including without limitation special, consequential or incidental damages. Buyer is responsible for its products and applications using **onsemi** products, including compliance with all laws, regulations and safety requirements or standards, regardless of any support or applications information provided by **onsemi**. "Typical" parameters which may be provided in **onsemi** data sheets and/or specifications can and do vary in different applications and actual performance may vary over time. All operating parameters, including "Typicals" must be validated for each customer application by customer's technical experts. **onsemi** does not convey any license under any of its intellectual property rights nor the rights of others. **onsemi** products are not designed, intended, or authorized for use as a critical component in life support systems or any FDA Class 3 medical devices or medical devices with a same or similar classification in a foreign jurisdiction or any devices intended for implantation in the human body. Should Buyer purchase or use **onsemi** products for any such unintended or unauthorized application, Buyer shall indemnify and hold **onsemi** and its officers, employees, subsidiaries, affiliates, and distributors harmless against all claims, costs, damages, and expenses, and reasonable attorney fees arising out of, directly or indirectly, any claim of personal injury or death associated with such unintended or unauthorized use, even if such claim alleges that **onsemi** was negligent regarding the design or manufacture of the part. **onsemi** is an Equal Opportunity/Affirmative Action Employer. This literature is subject to all applicable copyright laws and is not for resale in any manner.

ADDITIONAL INFORMATION

TECHNICAL PUBLICATIONS:

Technical Library: www.onsemi.com/design/resources/technical-documentation
onsemi Website: www.onsemi.com

ONLINE SUPPORT: www.onsemi.com/support

For additional information, please contact your local Sales Representative at www.onsemi.com/support/sales