

Motion SPM[®] 45 Series

FNB41060

General Description

FNB41060 is a Motion SPM45 module providing a fully-featured, high-performance inverter output stage for AC Induction, BLDC, and PMSM motors. These modules integrate optimized gate drive of the built-in IGBTs to minimize EMI and losses, while also providing multiple on-module protection features including under-voltage lockouts, over-current shutdown, thermal monitoring, and fault reporting. The built-in, high-speed HVIC requires only a single supply voltage and translates the incoming logic-level gate inputs to the high-voltage, high-current drive signals required to properly drive the module's robust short-circuit-rated IGBTs. Separate negative IGBT terminals are available for each phase to support the widest variety of control algorithms.

Features

- UL Certified No. E209204 (UL1557)
- 600 V – 10 A 3-Phase IGBT Inverter with Integral Gate Drivers and Protection
- Low Thermal Resistance Using Ceramic Substrate
- Low-Loss, Short-Circuit Rated IGBTs
- Built-In Bootstrap Diodes and Dedicated Vs Pins Simplify PCB Layout
- Built-In NTC Thermistor for Temperature Monitoring
- Separate Open-Emitter Pins from Low-Side IGBTs for Three-Phase Current Sensing
- Single-Grounded Power Supply
- Isolation Rating: 2000 V_{rms} / Min.
- This Device is Pb-Free and Halide Free

Applications

- Motion Control – Home Appliance / Industrial Motor

Integrated Power Functions

- 600 V – 10 A IGBT Inverter for Three-phase DC / AC Power Conversion (Please Refer to Figure 2)

Integrated Drive, Protection, and System Control Functions

- For Inverter High-side IGBTs: Gate Drive Circuit, High-voltage Isolated High-speed Level Shifting Control Circuit Under-Voltage Lock-Out (UVLO) Protection
- For Inverter Low-side IGBTs: Gate Drive Circuit, Short-Circuit Protection (SCP) Control Supply Circuit Under-Voltage Lock-Out (UVLO) Protection
- Fault Signaling: Corresponding to UVLO (Low-side Supply) and SC Faults
- Input Interface: Active-HIGH Interface, Works with 3.3 / 5 V Logic, Schmitt Trigger Input

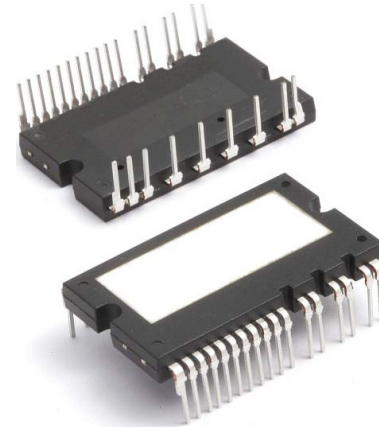

SPMAA-A26 / 26LD, PDD STD, CERAMIC TYPE,
STANDARD DUAL FORM
CASE MODFA

MARKING DIAGRAM

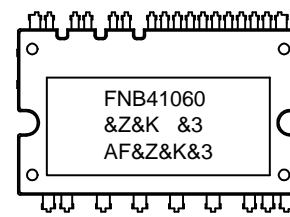

- FNB41060 = Specific Device Code
- &Z = Assembly Plant Code
- &K = 2-Digits Lot Run Traceability Code
- &3 = 3-Digit Date Code
- AF = Specific Product Name

ORDERING INFORMATION

Device	Package	Shipping
FNB41060	SPMAA-A26 (Pb-Free, Halide Free)	12 Units / Rail

Related Resources

- [AN-9070](#) – Motion SPM 45 Series Users Guide
- [AN-9071](#) – Motion SPM 45 Series Thermal Performance Information
- [AN-9072](#) – Motion SPM 45 Series Mounting Guidance
- RD-344 – Reference Design (Three Shunt Solution)
- RD-345 – Reference Design (One Shunt Solution)

FNB41060

PIN CONFIGURATION

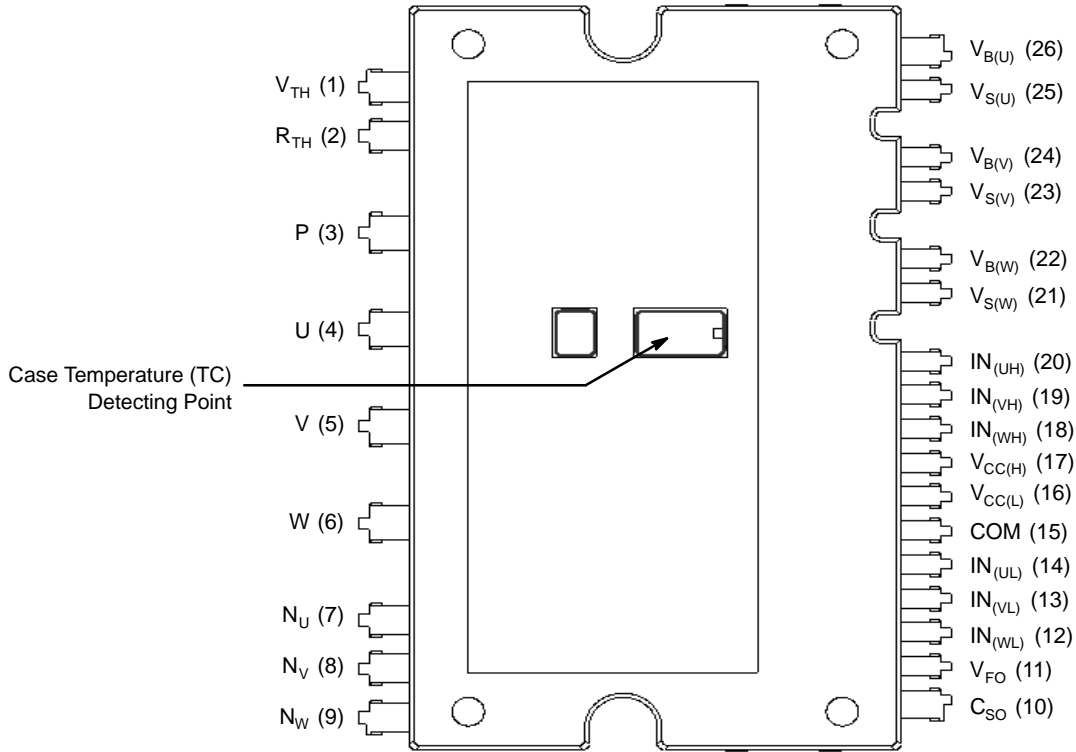

Figure 1. Top View

PIN DESCRIPTIONS

Pin Number	Pin Name	Pin Description
1	V _{TH}	Thermistor Bias Voltage
2	R _{TH}	Series Resistor for the Use of Thermistor (Temperature Detection)
3	P	Positive DC-Link Input
4	U	Output for U-Phase
5	V	Output for V-Phase
6	W	Output for W-Phase
7	N _U	Negative DC-Link Input for U-Phase
8	N _V	Negative DC-Link Input for V-Phase
9	N _W	Negative DC-Link Input for W-Phase
10	C _{SC}	Capacitor (Low-Pass Filter) for Short-circuit Current Detection Input
11	V _{FO}	Fault Output
12	IN _(WL)	Signal Input for Low-Side W-Phase
13	IN _(VL)	Signal Input for Low-Side V-Phase
14	IN _(UL)	Signal Input for Low-Side U-Phase
15	COM	Common Supply Ground
16	V _{CC(L)}	Low-Side Common Bias Voltage for IC and IGBTs Driving
17	V _{CC(H)}	High-Side Common Bias Voltage for IC and IGBTs Driving
18	IN _(WH)	Signal Input for High-Side W-Phase

FNB41060

ABSOLUTE MAXIMUM RATINGS ($T_J = 25^\circ\text{C}$ unless otherwise specified)

Symbol	Parameter	Conditions	Rating	Unit
INVERTER PART				
V_{PN}	Supply Voltage	Applied between P – N_U , N_V , N_W	450	V
$V_{PN(\text{Surge})}$	Supply Voltage (Surge)	Applied between P – N_U , N_V , N_W	500	V
V_{CES}	Collector–Emitter Voltage		600	V
$I_{O,25}$	Output Phase Current	$T_C = 25^\circ\text{C}$, $T_J < 150^\circ\text{C}$ (Note 4)	10	A
$I_{O,100}$	Output Phase Current	$T_C = 100^\circ\text{C}$, $T_J < 150^\circ\text{C}$ (Note 4)	5	A
I_{pk}	Output Peak Phase Current	$T_C = 25^\circ\text{C}$, $T_J < 150^\circ\text{C}$, Under 1 ms Pulse Width	15	A
P_C	Collector Dissipation	$T_C = 25^\circ\text{C}$ per Chip	32	W
T_J	Operating Junction Temperature	(Note 5)	– 40~150	$^\circ\text{C}$

CONTROL PART

V_{CC}	Control Supply Voltage	Applied between $V_{CC(H)}$, $V_{CC(L)} - \text{COM}$	20	V
V_{BS}	High–Side Control Bias Voltage	Applied between $V_{B(U)} - V_{S(U)}$, $V_{B(V)} - V_{S(V)}$, $V_{B(W)} - V_{S(W)}$	20	V
V_{IN}	Input Signal Voltage	Applied between $IN_{(UH)}$, $IN_{(VH)}$, $IN_{(WH)}$, $IN_{(UL)}$, $IN_{(VL)}$, $IN_{(WL)} - \text{COM}$	$-0.3 - V_{CC} + 0.3$	V
V_{FO}	Fault Output Supply Voltage	Applied between $V_{FO} - \text{COM}$	$-0.3 - V_{CC} + 0.3$	V
I_{FO}	Fault Output Current	Sink Current at V_{FO} pin	1	mA
V_{SC}	Current–Sensing Input Voltage	Applied between $C_{SC} - \text{COM}$	$-0.3 - V_{CC} + 0.3$	V

BOOTSTRAP DIODE PART

V_{RRM}	Maximum Repetitive Reverse Voltage		600	V
I_F	Forward Current	$T_C = 25^\circ\text{C}$, $T_J < 150^\circ\text{C}$	0.50	A
I_{FP}	Forward Current (Peak)	$T_C = 25^\circ\text{C}$, $T_J < 150^\circ\text{C}$, Under 1 ms Pulse Width	1.50	A
T_J	Operating Junction Temperature		–40~150	$^\circ\text{C}$

TOTAL SYSTEM

$V_{PN(\text{PROT})}$	Self–Protection Supply Voltage Limit (Short–Circuit Protection Capability)	$V_{CC} = V_{BS} = 13.5\text{--}16.5\text{ V}$ $T_J = 150^\circ\text{C}$, Non–Repetitive, $< 2\ \mu\text{s}$	400	V
T_{STG}	Storage Temperature		–40~125	$^\circ\text{C}$
V_{ISO}	Isolation Voltage	60 Hz, Sinusoidal, AC 1 Minute, Connect Pins to Heat Sink Plate	2000	V_{rms}

Stresses exceeding those listed in the Maximum Ratings table may damage the device. If any of these limits are exceeded, device functionality should not be assumed, damage may occur and reliability may be affected.

4. Sinusoidal PWM at $V_{PN} = 300\text{ V}$, $V_{CC} = V_{BS} = 15\text{ V}$, $T_J < 150^\circ\text{C}$, $F_{SW} = 20\text{ kHz}$, $MI = 0.9$, $PF = 0.8$.

5. The maximum junction temperature rating of the power chips integrated within the Motion SPM 45 product is 150°C .

THERMAL RESISTANCE

Symbol	Parameter	Conditions	Min	Typ	Max	Unit
$R_{th(j-c)Q}$	Junction to Case Thermal Resistance	Inverter IGBT part, (Per 1 / 6 Module)	–	–	3.8	$^\circ\text{C/W}$
$R_{th(j-c)F}$		Inverter FWDi part, (Per 1 / 6 Module)	–	–	4.8	$^\circ\text{C/W}$

6. For the measurement point of case temperature (T_C), please refer to Figure 1.

FNB41060

ELECTRICAL CHARACTERISTICS (T_J = 25°C unless otherwise specified)

Symbol	Parameter	Conditions	Min	Typ	Max	Unit		
INVERTER PART								
V _{CE(SAT)}	Collector–Emitter Saturation Voltage	V _{CC} = V _{BS} = 15 V V _{IN} = 5 V	I _C = 5 A, T _J = 25°C	–	1.5	2.0	V	
V _F	FWDi Forward Voltage	V _{IN} = 0 V	I _F = 5 A, T _J = 25°C	–	1.5	2.0	V	
HS	Switching Times	V _{PN} = 300 V, V _{CC} = V _{BS} = 15 V, I _C = 5 A, T _J = 25°C V _{IN} = 0 V ↔ 5 V, Inductive Load (Note 7)		t _{ON}	0.45	0.75	1.25	μs
				t _{C(ON)}	–	0.20	0.45	μs
				t _{OFF}	–	0.70	1.20	μs
				t _{C(OFF)}	–	0.15	0.40	μs
				t _{rr}	–	0.15	–	μs
LS	Switching Times	V _{PN} = 300 V, V _{CC} = V _{BS} = 15 V, I _C = 5 A, T _J = 25°C V _{IN} = 0 V ↔ 5 V, Inductive Load (Note 7)		t _{ON}	0.35	0.65	1.15	μs
				t _{C(ON)}	–	0.15	0.40	μs
				t _{OFF}	–	0.65	1.15	μs
				t _{C(OFF)}	–	0.15	0.40	μs
				t _{rr}	–	0.15	–	μs
I _{CES}	Collector – Emitter Leakage Current	V _{CE} = V _{CES}	–	–	1	mA		

Product parametric performance is indicated in the Electrical Characteristics for the listed test conditions, unless otherwise noted. Product performance may not be indicated by the Electrical Characteristics if operated under different conditions.

7. t_{ON} and t_{OFF} include the propagation delay time of the internal drive IC. t_{C(ON)} and t_{C(OFF)} are the switching times of IGBT itself under the given gate driving condition internally. For the detailed information, please see Figure 3.

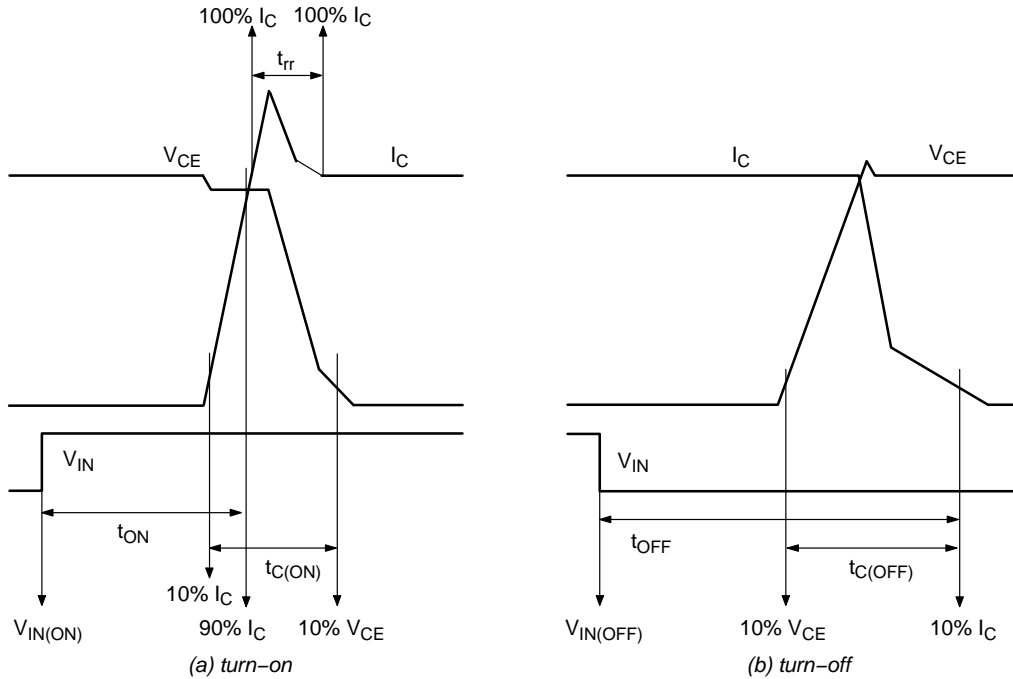

Figure 3. Switching Time Definition

FNB41060

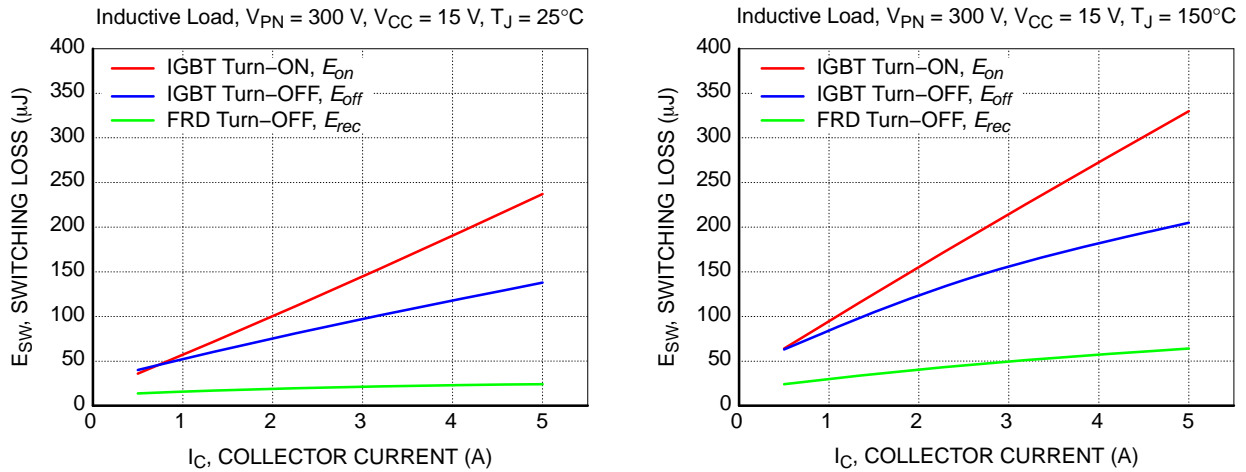

Figure 4. Switching Loss Characteristics (Typical)

ELECTRICAL CHARACTERISTICS ($T_J = 25^\circ\text{C}$ unless otherwise specified)

Symbol	Parameter	Conditions	Min	Typ	Max	Unit	
CONTROL PART							
I_{QCCH}	Quiescent V_{CC} Supply Current	$V_{CC(H)} = 15\text{ V}$, $I_{N(UH, VH, WH)} = 0\text{ V}$	$V_{CC(H)} - \text{COM}$	–	–	0.10	mA
I_{QCCL}		$V_{CC(L)} = 15\text{ V}$, $I_{N(UL, VL, WL)} = 0\text{ V}$	$V_{CC(L)} - \text{COM}$	–	–	2.65	mA
I_{PCCH}	Operating V_{CC} Supply Current	$V_{CC(L)} = 15\text{ V}$, $f_{PWM} = 20\text{ kHz}$, Duty = 50%, Applied to One PWM Signal Input for High-Side	$V_{CC(H)} - \text{COM}$	–	–	0.15	mA
I_{PCCL}		$V_{CC(L)} = 15\text{ V}$, $f_{PWM} = 20\text{ kHz}$, Duty = 50%, Applied to One PWM Signal Input for Low-Side	$V_{CC(L)} - \text{COM}$	–	–	3.65	mA
I_{QBS}	Quiescent V_{BS} Supply Current	$V_{BS} = 15\text{ V}$, $I_{N(UH, VH, WH)} = 0\text{ V}$	$V_{B(U)} - V_{S(U)}$, $V_{B(V)} - V_{S(V)}$, $V_{B(W)} - V_{S(W)}$	–	–	0.30	mA
I_{PBS}	Operating V_{BS} Supply Current	$V_{CC} = V_{BS} = 15\text{ V}$, $f_{PWM} = 20\text{ kHz}$, Duty = 50%, Applied to One PWM Signal Input for High-Side	$V_{B(U)} - V_{S(U)}$, $V_{B(V)} - V_{S(V)}$, $V_{B(W)} - V_{S(W)}$	–	–	2.00	mA
V_{FOH}	Fault Output Voltage	$V_{SC} = 0\text{ V}$, V_{FO} Circuit: 10 k Ω to 5 V Pull-up	4.5	–	–	V	
V_{FOL}		$V_{SC} = 1\text{ V}$, V_{FO} Circuit: 10 k Ω to 5 V Pull-up	–	–	0.5	V	
$V_{SC(ref)}$	Short-Circuit Current Trip Level	$V_{CC} = 15\text{ V}$ (Note 8)	0.45	0.50	0.55	V	
UV_{CCD}	Supply Circuit Under-Voltage Protection	Detection level	10.5	–	13.0	V	
UV_{CCR}		Reset level	11.0	–	13.5	V	
UV_{BSD}		Detection level	10.0	–	12.5	V	
UV_{BSR}		Reset level	10.5	–	13.0	V	
t_{FOD}	Fault-Out Pulse Width		30	–	–	μs	
$V_{IN(ON)}$	ON Threshold Voltage	Applied between $I_{N(UH)}$, $I_{N(VH)}$, $I_{N(WH)}$, $I_{N(UL)}$, $I_{N(VL)}$, $I_{N(WL)} - \text{COM}$	–	–	2.6	V	
$V_{IN(OFF)}$	OFF Threshold Voltage		0.8	–	–	V	
R_{TH}	Resistance of Thermister	@ $T_{TH} = 25^\circ\text{C}$, (Note 9)	–	47	–	k Ω	
		@ $T_{TH} = 100^\circ\text{C}$	–	2.9	–	k Ω	

Product parametric performance is indicated in the Electrical Characteristics for the listed test conditions, unless otherwise noted. Product performance may not be indicated by the Electrical Characteristics if operated under different conditions.

8. Short-circuit protection is functioning only at the low-sides.

9. T_{TH} is the temperature of thermister itself. To know case temperature (T_C), please make the experiment considering your application.

FNB41060

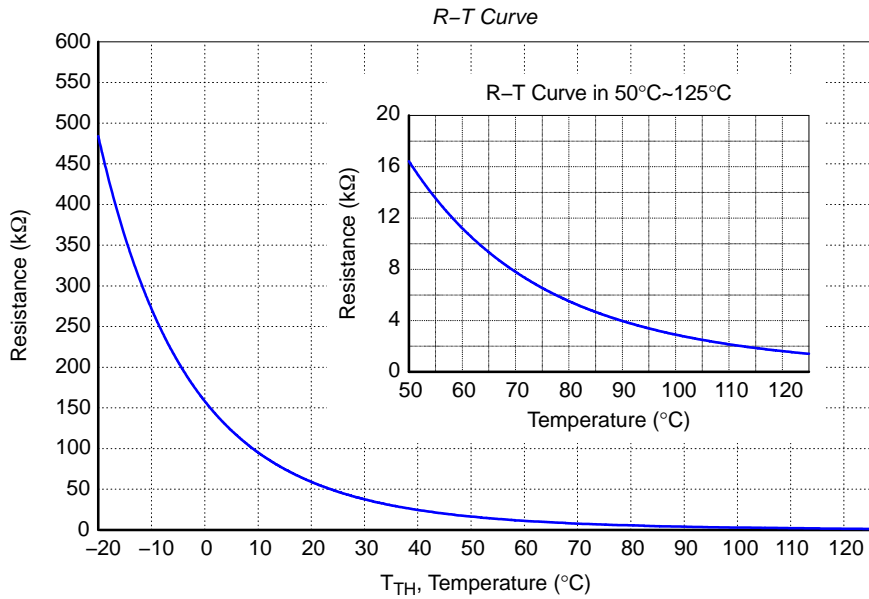

Figure 5. R-T Curve of The Built-In Thermistor

ELECTRICAL CHARACTERISTICS (T_J = 25°C unless otherwise specified)

Symbol	Parameter	Conditions	Min	Typ	Max	Unit
--------	-----------	------------	-----	-----	-----	------

BOOTSTRAP DIODE PART

V _F	Forward Voltage	I _F = 0.1 A, T _C = 25°C	-	2.5	-	V
t _{rr}	Reverse-Recovery Time	I _F = 0.1 A, T _C = 25°C	-	80	-	ns

Product parametric performance is indicated in the Electrical Characteristics for the listed test conditions, unless otherwise noted. Product performance may not be indicated by the Electrical Characteristics if operated under different conditions.

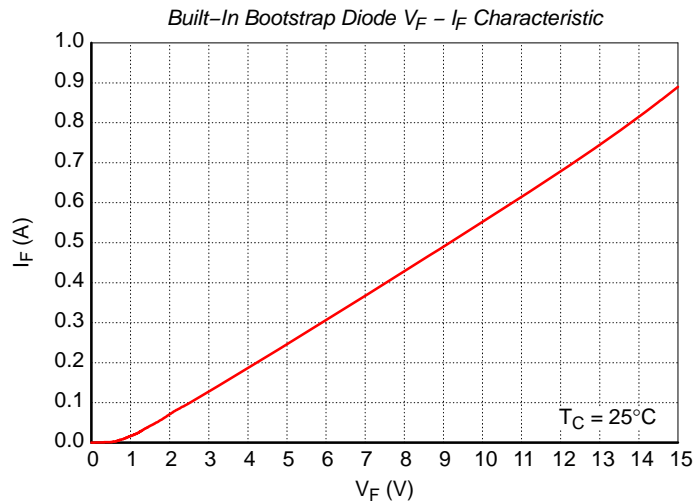

NOTE:

10. Built-in bootstrap diode includes around 15 Ω resistance characteristic.

Figure 6. R-T Curve of The Built-In Thermistor

FNB41060

RECOMMENDED OPERATING CONDITIONS

Symbol	Parameter	Conditions	Min	Typ	Max	Unit
V_{PN}	Supply Voltage	Applied between P – N_U , N_V , N_W	–	300	400	V
V_{CC}	Control Supply Voltage	Applied between $V_{CC(H)}$, $V_{CC(L)} - COM$	13.5	15	16.5	V
V_{BS}	High-Side Bias Voltage	Applied between $V_{B(U)} - V_{S(U)}$, $V_{B(V)} - V_{S(V)}$, $V_{B(W)} - V_{S(W)}$	13.0	15	18.5	V
dV_{CC}/dt , dV_{BS}/dt	Control Supply Variation		–1	–	1	V / μ s
t_{dead}	Blanking Time for Preventing Arm-Short	For each input signal	1.5	–	–	μ s
f_{PWM}	PWM Input Signal	$-40^\circ\text{C} < T_J < 150^\circ\text{C}$	–	–	20	kHz
V_{SEN}	Voltage for Current Sensing	Applied between N_U , N_V , $N_W - COM$ (Including Surge-Voltage)	–4	–	4	V
$P_{WIN(ON)}$	Minimum Input Pulse Width	(Note 11)	0.5	–	–	μ s
$P_{WIN(OFF)}$			0.5	–	–	

Functional operation above the stresses listed in the Recommended Operating Ranges is not implied. Extended exposure to stresses beyond the Recommended Operating Ranges limits may affect device reliability.

11. This product might not make response if input pulse width is less than the recommended value.

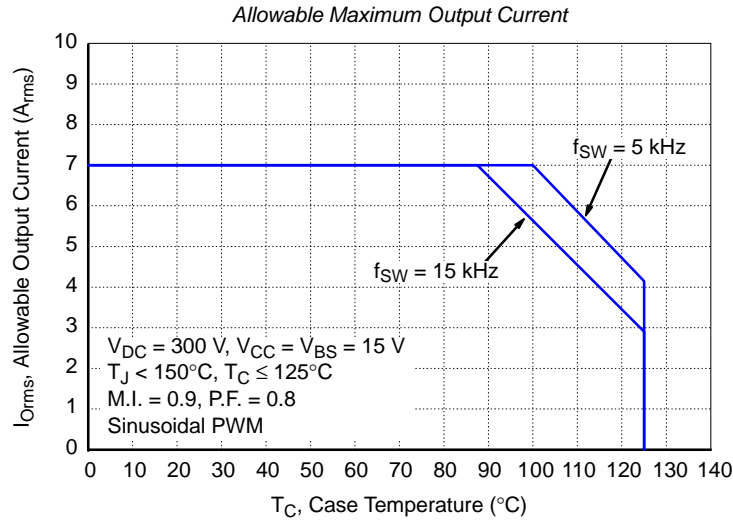

NOTE:

12. This allowable output current value is the reference data for the safe operation of this product. This may be different from the actual application and operating condition.

Figure 7. Allowable Maximum Output Current

FNB41060

MECHANICAL CHARACTERISTICS AND RATINGS

Parameter	Conditions	Min	Typ	Max	Unit	
Device Flatness	See Figure 8	0	–	+120	μm	
Mounting Torque	Mounting Screw: M3 See Figure 9	Recommended 0.7 N • m	0.6	0.7	0.8	N • m
		Recommended 7.1 kg • cm	6.2	7.1	8.1	kg • cm
Weight		–	11	–	g	

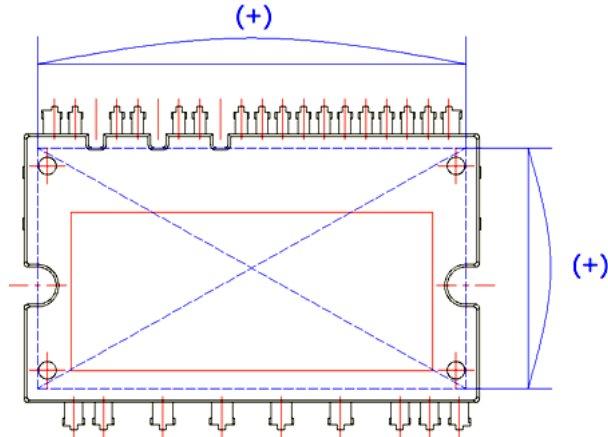
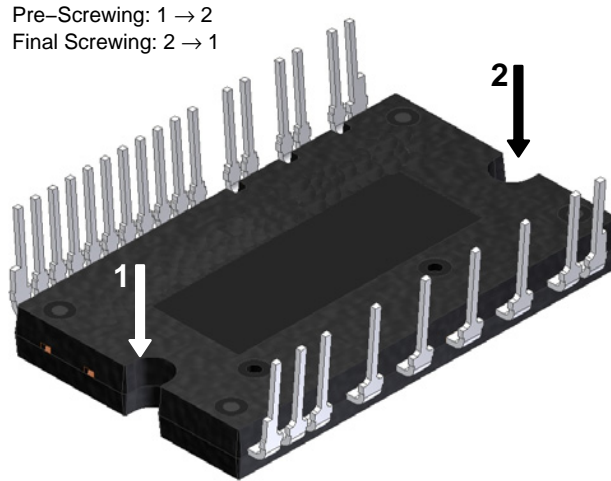

Figure 8. Flatness Measurement Position



NOTES:

- 13. Do not make over torque when mounting screws. Much mounting torque may cause ceramic cracks, as well as bolts and Al heat-sink destruction.
- 14. Avoid one side tightening stress. Figure 9 shows the recommended torque order for mounting screws. Uneven mounting can cause the ceramic substrate of the SPM 45 package to be damaged. The pre-screwing torque is set to 20~30% of maximum torque rating.

Figure 9. Mounting Screws Torque Order

TIME CHARTS OF PROTECTIVE FUNCTION

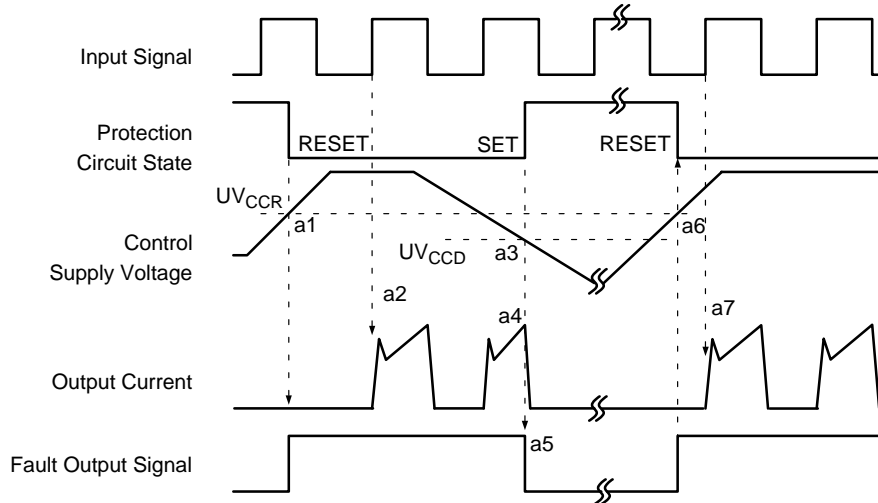

- a1: Control supply voltage rises: after the voltage rises UV_{CCR} , the circuits start to operate when next input is applied.
- a2: Normal operation: IGBT ON and carrying current.
- a3: Under-voltage detection (UV_{CCD}).
- a4: IGBT OFF in spite of control input condition.
- a5: Fault output operation starts.
- a6: Under-voltage reset (UV_{CCR}).
- a7: Normal operation: IGBT ON and carrying current.

Figure 10. Under-Voltage Protection (Low-Side)

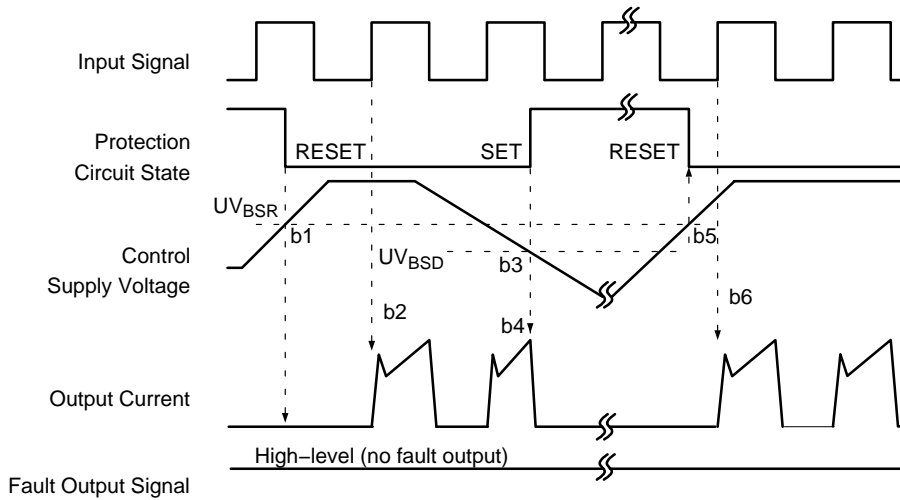

- b1: Control supply voltage rises: after the voltage reaches UV_{BSR} , the circuits start to operate when next input is applied.
- b2: Normal operation: IGBT ON and carrying current.
- b3: Under-voltage detection (UV_{BSD}).
- b4: IGBT OFF in spite of control input condition, but there is no fault output signal.
- b5: Under-voltage reset (UV_{BSR}).
- b6: Normal operation: IGBT ON and carrying current.

Figure 11. Under-Voltage Protection (High-Side)

FNB41060

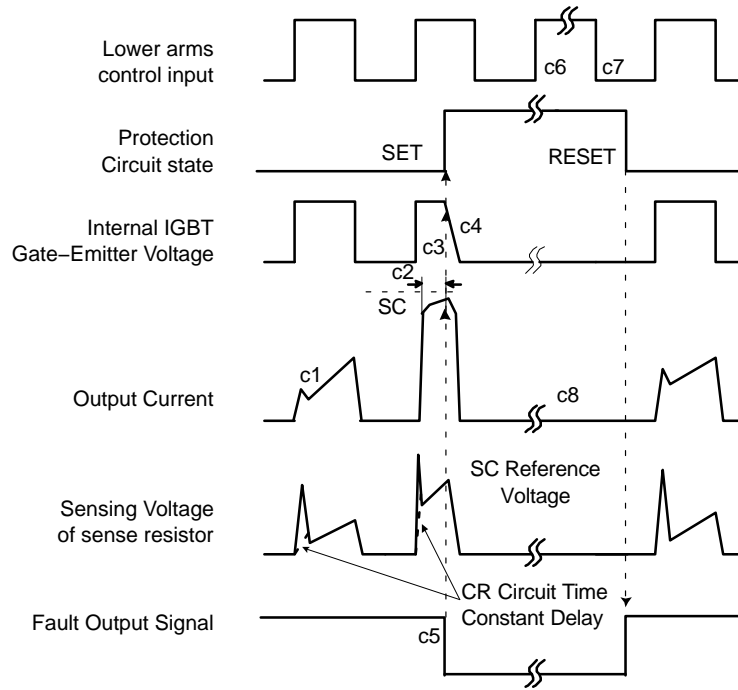

(with the external shunt resistance and CR connection)

- c1: Normal operation: IGBT ON and carrying current.
- c2: Short-circuit current detection (SC trigger).
- c3: Hard IGBT gate interrupt.
- c4: IGBT turns OFF.
- c5: Input "LOW": IGBT OFF state.
- c6: Input "HIGH": IGBT ON state, but during the active period of fault output, the IGBT doesn't turn ON.
- c7: IGBT OFF state.

Figure 12. Short-Circuit Protection (Low-Side Operation Only)

INPUT/OUTPUT INTERFACE CIRCUIT

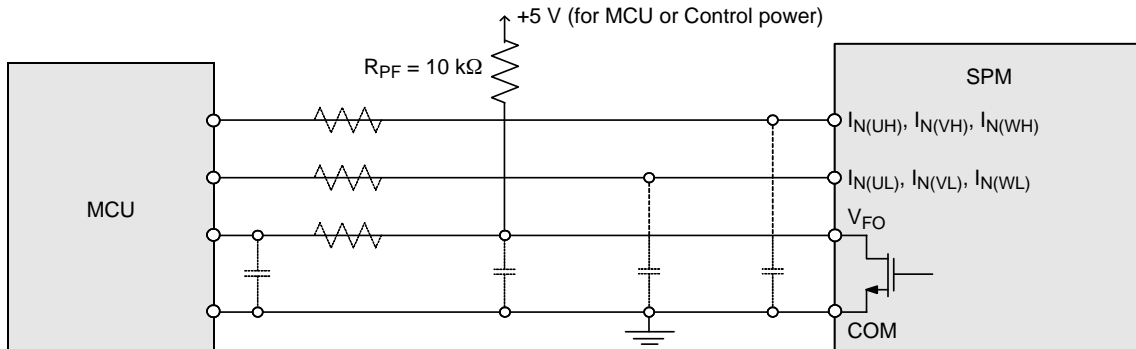

NOTE:

15. RC coupling at each input (parts shown dotted) might change depending on the PWM control scheme in the application and the wiring impedance of the application's printed circuit board. The input signal section of the Motion SPM 45 product integrates a 5 kΩ (typ.) pull-down resistor. Therefore, when using an external filtering resistor, pay attention to the signal voltage drop at input terminal.

Figure 13. Recommended MCU I/O Interface Circuit

FNB41060

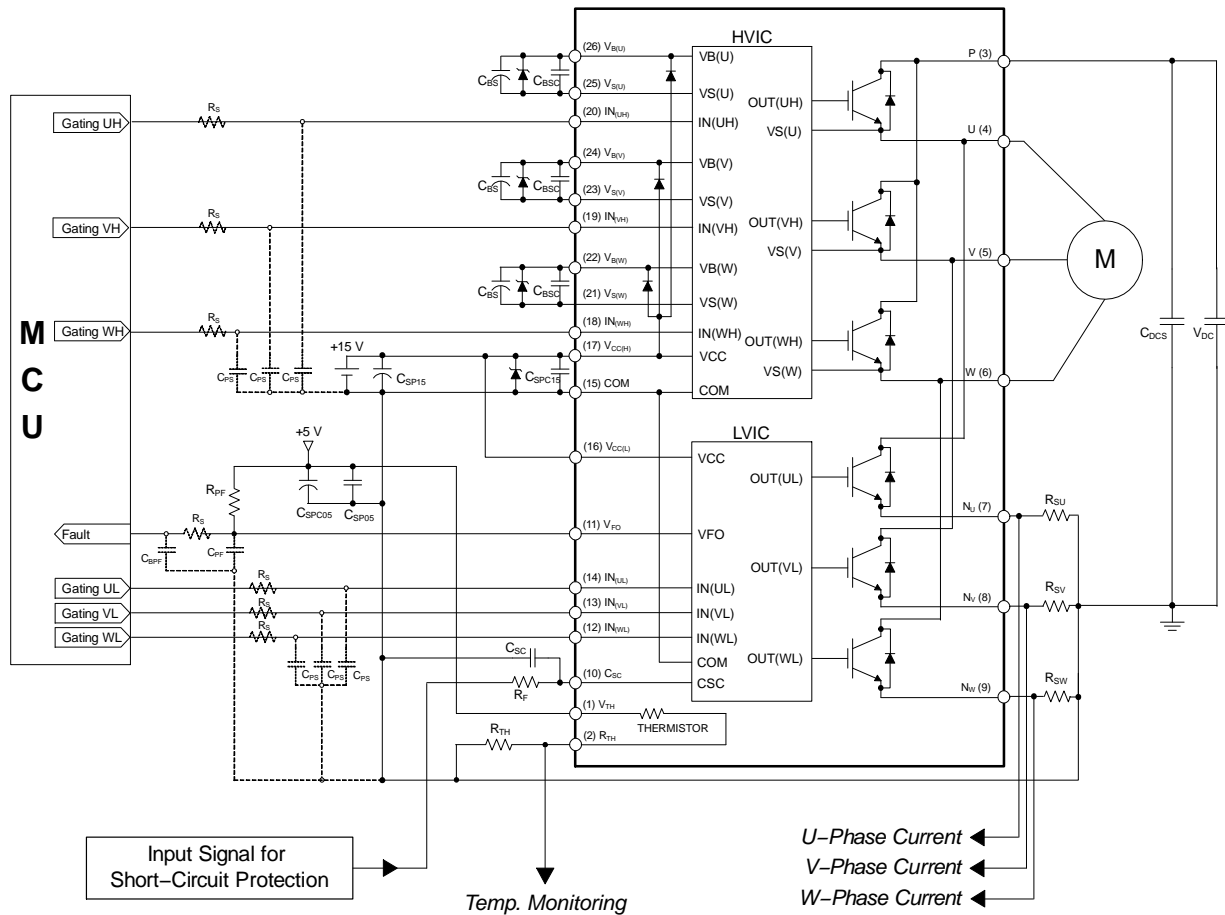

NOTES:

16. To avoid malfunction, the wiring of each input should be as short as possible (less than 2–3 cm).
17. By virtue of integrating an application-specific type of HVIC inside the Motion SPM 45 product, direct coupling to MCU terminals without any optocoupler or transformer isolation is possible.
18. V_{FO} output is open-drain type. This signal line should be pulled up to the positive side of the MCU or control power supply with a resistor that makes I_{FO} up to 1 mA (please refer to Figure 13).
19. C_{SP15} of around seven times larger than bootstrap capacitor C_{BS} is recommended.
20. Input signal is active-HIGH type. There is a 5 k Ω resistor inside the IC to pull down each input signal line to GND. RC coupling circuits are recommended for the prevention of input signal oscillation. $R_S C_{PS}$ time constant should be selected in the range 50~50 ns (recommended $R_S = 100 \Omega$, $C_{PS} = 1$ nF).
21. To prevent errors of the protection function, the wiring around R_F and C_{SC} should be as short as possible.
22. In the short-circuit protection circuit, please select the $R_F C_{SC}$ time constant in the range 1.5~2 μ s.
23. The connection between control GND line and power GND line which includes the N_U , N_V , N_W must be connected to only one point. Please do not connect the control GND to the power GND by the broad pattern. Also, the wiring distance between control GND and power GND should be as short as possible.
24. Each capacitor should be mounted as close to the pins of the Motion SPM 45 product as possible.
25. To prevent surge destruction, the wiring between the smoothing capacitor and the P & GND pins should be as short as possible. The use of a high-frequency non-inductive capacitor of around 0.1~0.22 μ F between the P and GND pins is recommended.
26. Relays are used in almost every systems of electrical equipment in home appliances. In these cases, there should be sufficient distance between the MCU and the relays.
27. The zener diode or transient voltage suppressor should be adopted for the protection of ICs from the surge destruction between each pair of control supply terminals (recommended zener diode is 22 V / 1 W, which has the lower zener impedance characteristic than about 15 Ω).
28. Please choose the electrolytic capacitor with good temperature characteristic in C_{BS} . Also, choose 0.1~0.2 μ F R-category ceramic capacitors with good temperature and frequency characteristics in C_{BSC} .
29. For the detailed information, please refer to the AN-9070, AN-9071, AN-9072, RD-344, and RD-345.

Figure 14. Typical Application Circuit

SPM is a registered trademark of Semiconductor Components Industries, LLC dba "onsemi" or its affiliates and/or subsidiaries in the United States and/or other countries.

MECHANICAL CASE OUTLINE

PACKAGE DIMENSIONS

ON Semiconductor®



SPMAA-A26 / 26LD, PDD STD, CERAMIC TYPE, STANDARD DUAL FORM

CASE MODFA

ISSUE O

DATE 31 JAN 2017

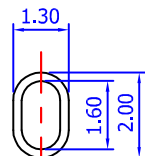
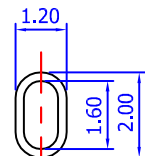
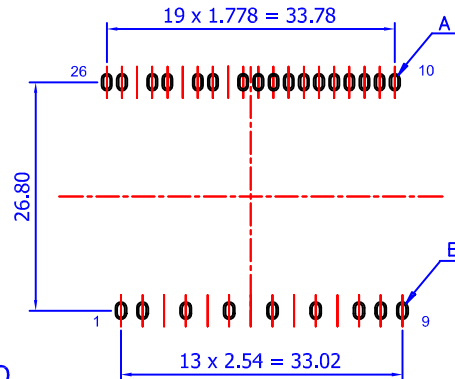
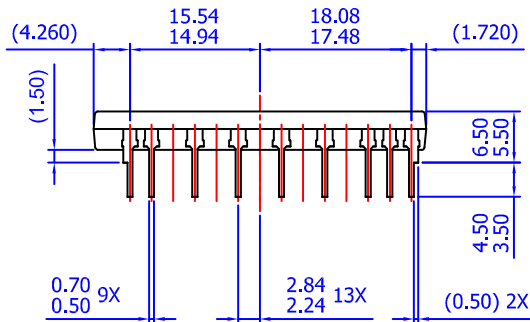
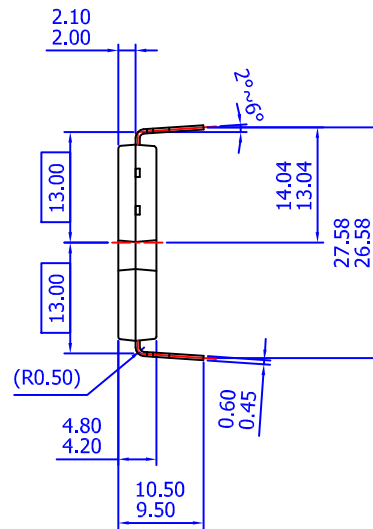
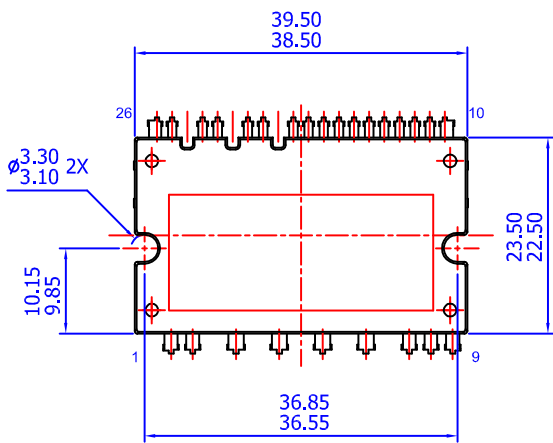
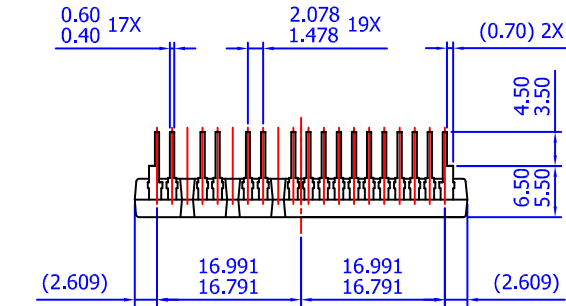

- NOTES: UNLESS OTHERWISE SPECIFIED
- A) THIS PACKAGE DOES NOT COMPLY TO ANY CURRENT PACKAGING STANDARD
 - B) ALL DIMENSIONS ARE IN MILLIMETERS
 - C) DIMENSIONS ARE EXCLUSIVE OF BURRS, MOLD FLASH, AND TIE BAR EXTRUSIONS
 - D) () IS REFERENCE

LAND PATTERN RECOMMENDATIONS

DOCUMENT NUMBER:	98AON13553G	Electronic versions are uncontrolled except when accessed directly from the Document Repository. Printed versions are uncontrolled except when stamped "CONTROLLED COPY" in red.
DESCRIPTION:	SPMAA-A26 / 26LD, PDD STD, CERAMIC TYPE, STANDARD DUAL	PAGE 1 OF 1

ON Semiconductor and ON are trademarks of Semiconductor Components Industries, LLC dba ON Semiconductor or its subsidiaries in the United States and/or other countries. ON Semiconductor reserves the right to make changes without further notice to any products herein. ON Semiconductor makes no warranty, representation or guarantee regarding the suitability of its products for any particular purpose, nor does ON Semiconductor assume any liability arising out of the application or use of any product or circuit, and specifically disclaims any and all liability, including without limitation special, consequential or incidental damages. ON Semiconductor does not convey any license under its patent rights nor the rights of others.

onsemi, **Onsemi**, and other names, marks, and brands are registered and/or common law trademarks of Semiconductor Components Industries, LLC dba "**onsemi**" or its affiliates and/or subsidiaries in the United States and/or other countries. **onsemi** owns the rights to a number of patents, trademarks, copyrights, trade secrets, and other intellectual property. A listing of **onsemi**'s product/patent coverage may be accessed at www.onsemi.com/site/pdf/Patent-Marking.pdf. **onsemi** reserves the right to make changes at any time to any products or information herein, without notice. The information herein is provided "as-is" and **onsemi** makes no warranty, representation or guarantee regarding the accuracy of the information, product features, availability, functionality, or suitability of its products for any particular purpose, nor does **onsemi** assume any liability arising out of the application or use of any product or circuit, and specifically disclaims any and all liability, including without limitation special, consequential or incidental damages. Buyer is responsible for its products and applications using **onsemi** products, including compliance with all laws, regulations and safety requirements or standards, regardless of any support or applications information provided by **onsemi**. "Typical" parameters which may be provided in **onsemi** data sheets and/or specifications can and do vary in different applications and actual performance may vary over time. All operating parameters, including "Typicals" must be validated for each customer application by customer's technical experts. **onsemi** does not convey any license under any of its intellectual property rights nor the rights of others. **onsemi** products are not designed, intended, or authorized for use as a critical component in life support systems or any FDA Class 3 medical devices or medical devices with a same or similar classification in a foreign jurisdiction or any devices intended for implantation in the human body. Should Buyer purchase or use **onsemi** products for any such unintended or unauthorized application, Buyer shall indemnify and hold **onsemi** and its officers, employees, subsidiaries, affiliates, and distributors harmless against all claims, costs, damages, and expenses, and reasonable attorney fees arising out of, directly or indirectly, any claim of personal injury or death associated with such unintended or unauthorized use, even if such claim alleges that **onsemi** was negligent regarding the design or manufacture of the part. **onsemi** is an Equal Opportunity/Affirmative Action Employer. This literature is subject to all applicable copyright laws and is not for resale in any manner.

ADDITIONAL INFORMATION

TECHNICAL PUBLICATIONS:

Technical Library: www.onsemi.com/design/resources/technical-documentation
onsemi Website: www.onsemi.com

ONLINE SUPPORT: www.onsemi.com/support

For additional information, please contact your local Sales Representative at www.onsemi.com/support/sales

