

# Ultrafast Rectifier

60 A, 600 V

## FFH60UP60S, FFH60UP60S3

### Description

The FFH60UP60S, FFH60UP60S3 is an ultrafast diode with low forward voltage drop and rugged UIS capability. This device is intended for use as freewheeling and clamping diodes in a variety of switching power supplies and other power switching applications. It is specially suited for use in switching power supplies and industrial applications as welder and UPS application.

### Features

- Ultrafast Recovery,  $t_{rr} = 80 \text{ ns}$  (@  $I_F = 60 \text{ A}$ )
- Max Forward Voltage,  $V_F = 1.7 \text{ V}$  (@  $T_C = 25^\circ\text{C}$ )
- Avalanche Energy Rated
- These Devices are Pb-Free, Halogen Free/BFR Free and are RoHS Compliant

### Applications

- General Purpose
- SMPS, Welder, UPS
- Free-wheeling Diode for Motor Application
- Power Switching Circuits

### ABSOLUTE MAXIMUM RATINGS ( $T_C = 25^\circ\text{C}$ unless otherwise noted)

Symbol	Rating	Value	Unit
$V_{RRM}$	Peak Repetitive Reverse Voltage	600	V
$V_{RWM}$	Working Peak Reverse Voltage	600	V
$V_R$	DC Blocking Voltage	600	V
$I_{F(AV)}$	Average Rectified Forward Current @ $T_C = 93^\circ\text{C}$	60	A
$I_{FSM}$	Non-repetitive Peak Surge Current 60 Hz Single Half-Sine Wave	600	A
$T_J, T_{STG}$	Operating and Storage Temperature	-65 to +175	$^\circ\text{C}$

Stresses exceeding those listed in the Maximum Ratings table may damage the device. If any of these limits are exceeded, device functionality should not be assumed, damage may occur and reliability may be affected.

### THERMAL CHARACTERISTICS

Symbol	Parameter	Value	Unit
$R_{\theta JC}$	Maximum Thermal Resistance, Junction to Case	0.7	$^\circ\text{C/W}$

### PIN ASSIGNMENTS

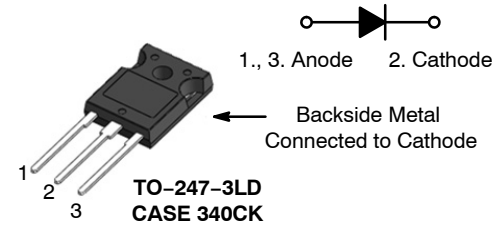
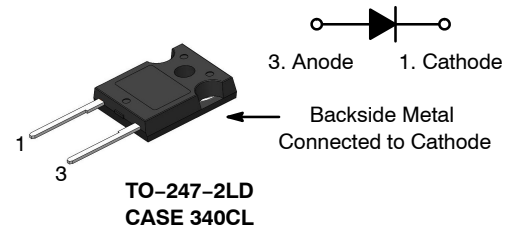

### MARKING DIAGRAM

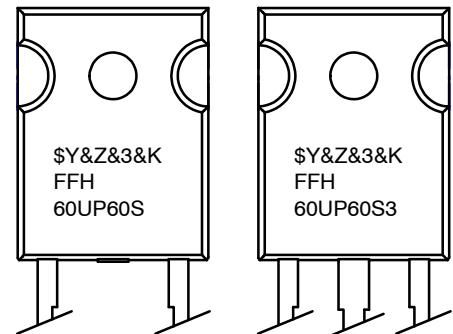

\$Y = onsemi Logo  
&Z = Assembly Plant Code  
&3 = Numeric Date Code  
&K = Lot Code  
FFH60UP60Sx = Specific Device Code

### ORDERING INFORMATION

See detailed ordering and shipping information on page 2 of this data sheet.

## FFH60UP60S, FFH60UP60S3

### ELECTRICAL CHARACTERISTICS ( $T_C = 25^\circ\text{C}$ unless otherwise noted)

Symbol	Parameter	Min	Typ	Max	Unit	
$V_F$ (Note 1)	$I_F = 60\text{ A}$	$T_C = 25^\circ\text{C}$	-	1.4	1.7	V
		$T_C = 125^\circ\text{C}$	-	1.3	-	
$I_R$ (Note 1)	$V_R = 600\text{ V}$	$T_C = 25^\circ\text{C}$	-	-	100	$\mu\text{A}$
		$T_C = 125^\circ\text{C}$	-	-	500	
$t_{rr}$	$I_F = 60\text{ A}$ , $di_F/dt = 200\text{ A}/\mu\text{s}$ , $V_R = 390\text{ V}$	$T_C = 25^\circ\text{C}$	-	60	80	ns
		$T_C = 125^\circ\text{C}$	-	138	-	
$W_{AVL}$	Avalanche Energy ( $L = 40\text{ mH}$ )	50	-	-	mJ	

Product parametric performance is indicated in the Electrical Characteristics for the listed test conditions, unless otherwise noted. Product performance may not be indicated by the Electrical Characteristics if operated under different conditions.

1. Pulse: Test Pulse Width = 300  $\mu\text{s}$ , Duty Cycle = 2%

### ORDERING INFORMATION

Part Number	Device Marking	Package	Shipping
FFH60UP60S	FFH60UP60S	TO-247-2LD (Pb-Free / Halogen Free)	450 Units / Tube
FFH60UP60S3	FFH60UP60S3	TO-247-3LD (Pb-Free / Halogen Free)	450 Units / Tube

# FFH60UP60S, FFH60UP60S3

## TEST CIRCUIT AND WAVEFORM

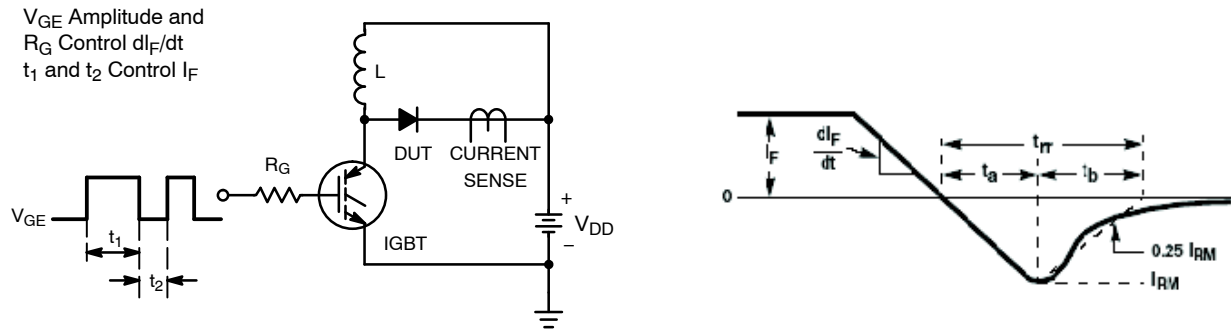

Figure 1. Diode Reverse Recovery Test Circuit and Waveform

$L = 40 \text{ mH}$   
 $R < 0.1 \Omega$   
 $V_{DD} = 50 \text{ V}$   
 $E_{AVL} = 1/2LI^2 [V_{R(AVL)} / (V_{R(AVL)} - V_{DD})]$   
 $Q1 = \text{IGBT (} BV_{CES} > \text{DUT } V_{R(AVL)})$

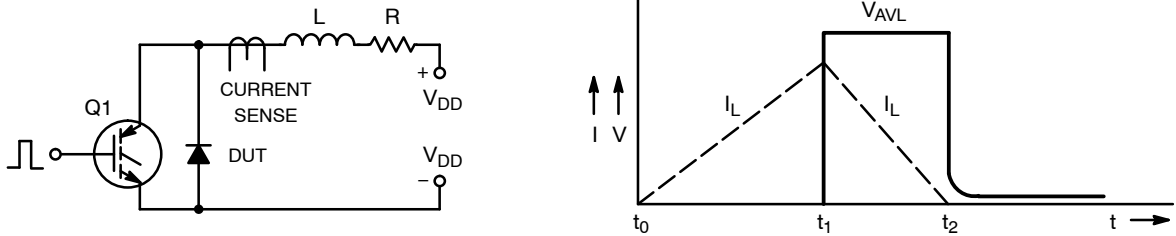

Figure 2. Unclamped Inductive Switching Test Circuit & Waveform

TYPICAL PERFORMANCE CHARACTERISTICS

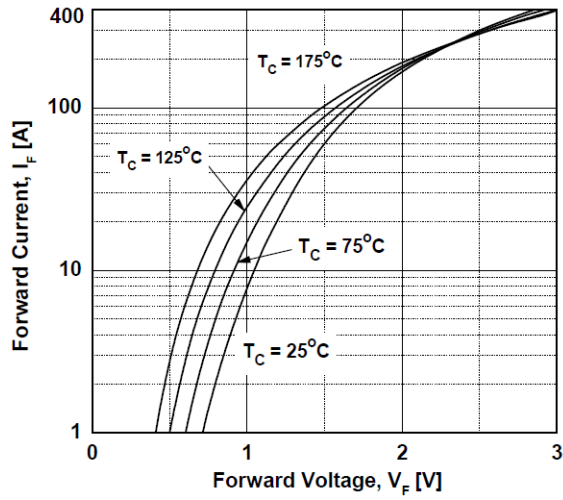

Figure 3. Typical Forward Voltage Drop vs. Forward Current

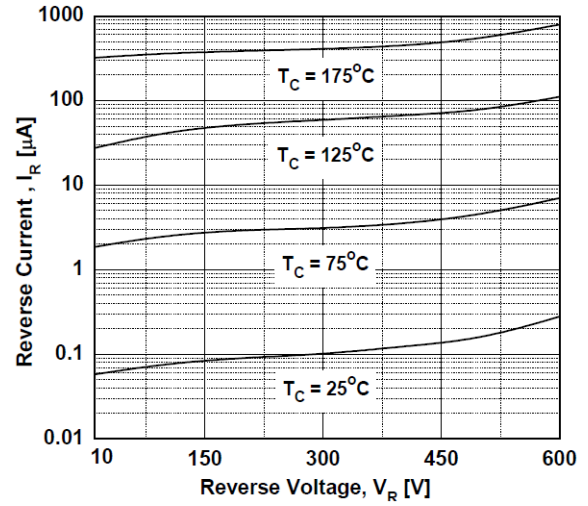

Figure 4. Typical Reverse Current vs. Reverse Voltage

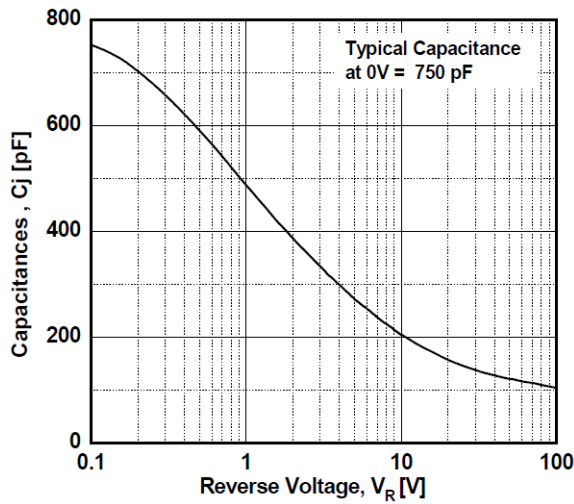

Figure 5. Typical Junction Capacitance

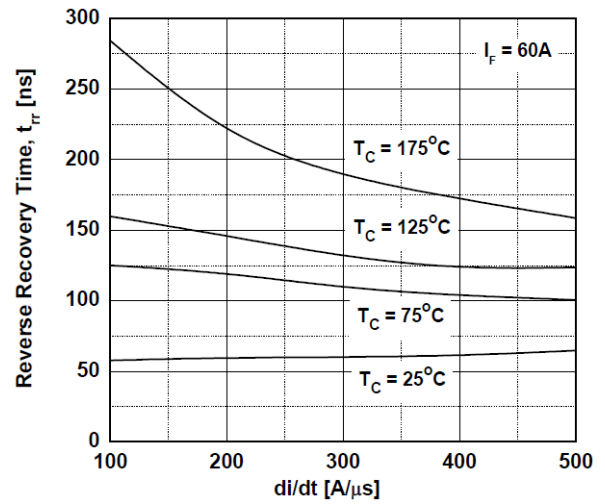

Figure 6. Typical Reverse Recovery Time vs.  $di_F/dt$

# FFH60UP60S, FFH60UP60S3

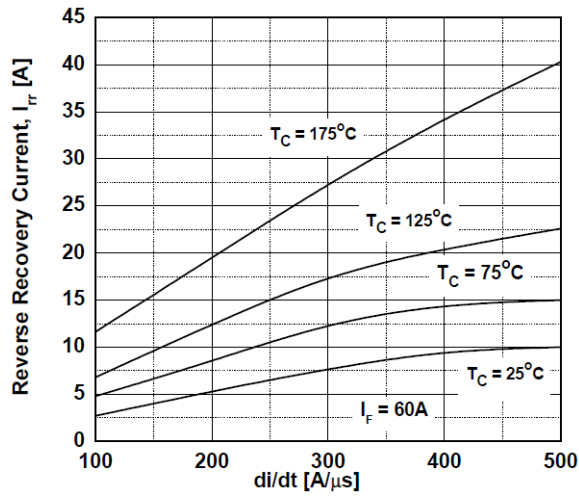

Figure 7. Typical Reverse Recovery Current vs.  $di_F/dt$

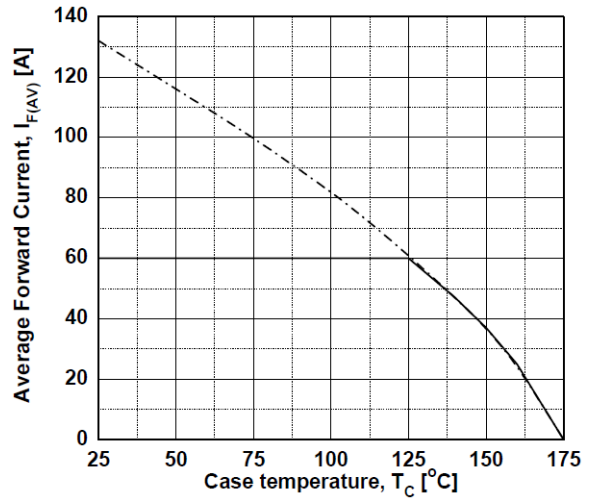

Figure 8. Forward Current Derating Curve

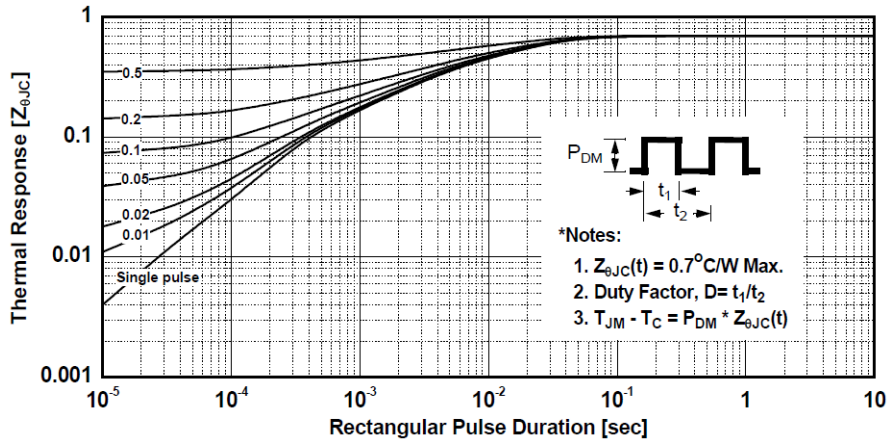
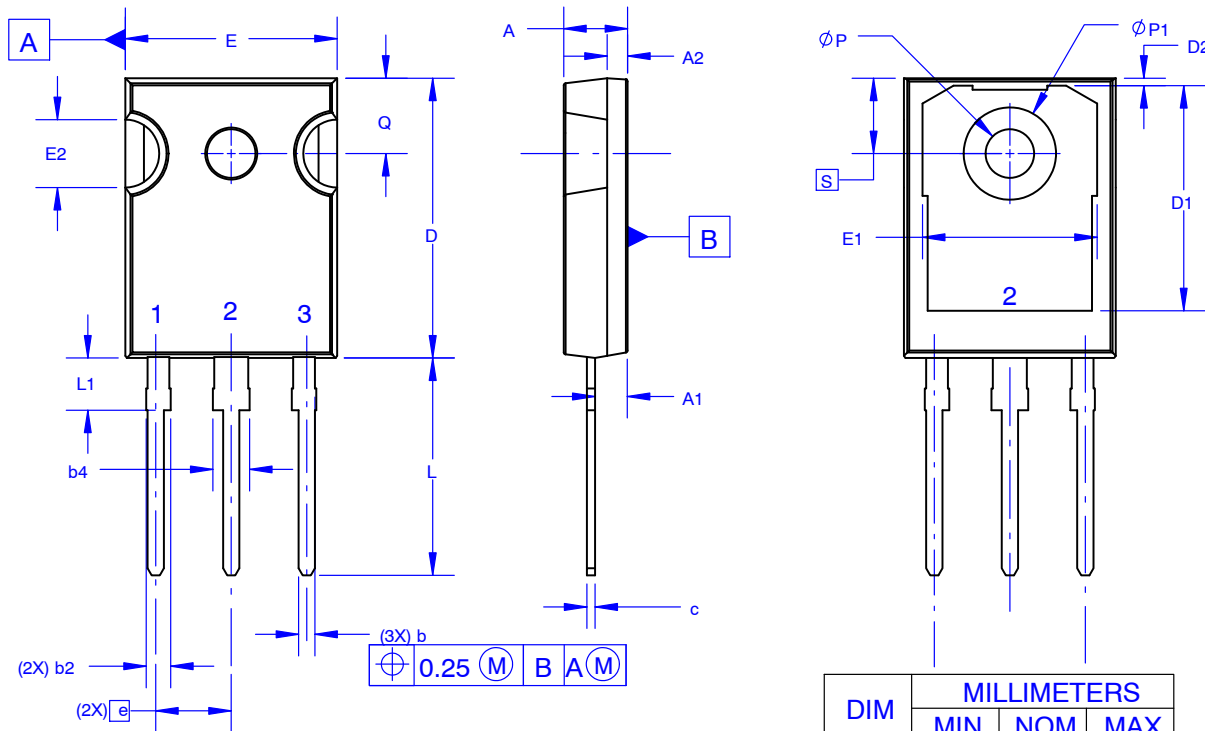

Figure 9. Transient Thermal Response Curve

**TO-247-3LD SHORT LEAD**  
**CASE 340CK**  
**ISSUE A**

DATE 31 JAN 2019



NOTES: UNLESS OTHERWISE SPECIFIED.

- A. DIMENSIONS ARE EXCLUSIVE OF BURRS, MOLD FLASH, AND TIE BAR EXTRUSIONS.
- B. ALL DIMENSIONS ARE IN MILLIMETERS.
- C. DRAWING CONFORMS TO ASME Y14.5 - 2009.
- D. DIMENSION A1 TO BE MEASURED IN THE REGION DEFINED BY L1.
- E. LEAD FINISH IS UNCONTROLLED IN THE REGION DEFINED BY L1.

**GENERIC MARKING DIAGRAM\***

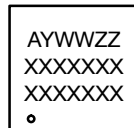

- XXXX = Specific Device Code
- A = Assembly Location
- Y = Year
- WW = Work Week
- ZZ = Assembly Lot Code

\*This information is generic. Please refer to device data sheet for actual part marking. Pb-Free indicator, "G" or microdot "•", may or may not be present. Some products may not follow the Generic Marking.

DIM	MILLIMETERS		
	MIN	NOM	MAX
A	4.58	4.70	4.82
A1	2.20	2.40	2.60
A2	1.40	1.50	1.60
b	1.17	1.26	1.35
b2	1.53	1.65	1.77
b4	2.42	2.54	2.66
c	0.51	0.61	0.71
D	20.32	20.57	20.82
D1	13.08	~	~
D2	0.51	0.93	1.35
E	15.37	15.62	15.87
E1	12.81	~	~
E2	4.96	5.08	5.20
e	~	5.56	~
L	15.75	16.00	16.25
L1	3.69	3.81	3.93
∅P	3.51	3.58	3.65
∅P1	6.60	6.80	7.00
Q	5.34	5.46	5.58
S	5.34	5.46	5.58

<b>DOCUMENT NUMBER:</b>	98AON13851G	Electronic versions are uncontrolled except when accessed directly from the Document Repository. Printed versions are uncontrolled except when stamped "CONTROLLED COPY" in red.
<b>DESCRIPTION:</b>	TO-247-3LD SHORT LEAD	<b>PAGE 1 OF 1</b>

ON Semiconductor and are trademarks of Semiconductor Components Industries, LLC dba ON Semiconductor or its subsidiaries in the United States and/or other countries. ON Semiconductor reserves the right to make changes without further notice to any products herein. ON Semiconductor makes no warranty, representation or guarantee regarding the suitability of its products for any particular purpose, nor does ON Semiconductor assume any liability arising out of the application or use of any product or circuit, and specifically disclaims any and all liability, including without limitation special, consequential or incidental damages. ON Semiconductor does not convey any license under its patent rights nor the rights of others.



**onsemi**, **Onsemi**, and other names, marks, and brands are registered and/or common law trademarks of Semiconductor Components Industries, LLC dba "**onsemi**" or its affiliates and/or subsidiaries in the United States and/or other countries. **onsemi** owns the rights to a number of patents, trademarks, copyrights, trade secrets, and other intellectual property. A listing of **onsemi**'s product/patent coverage may be accessed at [www.onsemi.com/site/pdf/Patent-Marking.pdf](http://www.onsemi.com/site/pdf/Patent-Marking.pdf). **onsemi** reserves the right to make changes at any time to any products or information herein, without notice. The information herein is provided "as-is" and **onsemi** makes no warranty, representation or guarantee regarding the accuracy of the information, product features, availability, functionality, or suitability of its products for any particular purpose, nor does **onsemi** assume any liability arising out of the application or use of any product or circuit, and specifically disclaims any and all liability, including without limitation special, consequential or incidental damages. Buyer is responsible for its products and applications using **onsemi** products, including compliance with all laws, regulations and safety requirements or standards, regardless of any support or applications information provided by **onsemi**. "Typical" parameters which may be provided in **onsemi** data sheets and/or specifications can and do vary in different applications and actual performance may vary over time. All operating parameters, including "Typicals" must be validated for each customer application by customer's technical experts. **onsemi** does not convey any license under any of its intellectual property rights nor the rights of others. **onsemi** products are not designed, intended, or authorized for use as a critical component in life support systems or any FDA Class 3 medical devices or medical devices with a same or similar classification in a foreign jurisdiction or any devices intended for implantation in the human body. Should Buyer purchase or use **onsemi** products for any such unintended or unauthorized application, Buyer shall indemnify and hold **onsemi** and its officers, employees, subsidiaries, affiliates, and distributors harmless against all claims, costs, damages, and expenses, and reasonable attorney fees arising out of, directly or indirectly, any claim of personal injury or death associated with such unintended or unauthorized use, even if such claim alleges that **onsemi** was negligent regarding the design or manufacture of the part. **onsemi** is an Equal Opportunity/Affirmative Action Employer. This literature is subject to all applicable copyright laws and is not for resale in any manner.

## ADDITIONAL INFORMATION

### TECHNICAL PUBLICATIONS:

Technical Library: [www.onsemi.com/design/resources/technical-documentation](http://www.onsemi.com/design/resources/technical-documentation)  
onsemi Website: [www.onsemi.com](http://www.onsemi.com)

### ONLINE SUPPORT: [www.onsemi.com/support](http://www.onsemi.com/support)

For additional information, please contact your local Sales Representative at [www.onsemi.com/support/sales](http://www.onsemi.com/support/sales)