

FDMS6681Z

MOSFET – POWERTRENCH[®], P-Channel

-30 V, -122 A, 3.2 mΩ

General Description

The FDMS6681Z has been designed to minimize losses in load switch applications. Advancements in both silicon and package technologies have been combined to offer the lowest $r_{DS(on)}$ and ESD protection.

Features

- Max $r_{DS(on)}$ = 3.2 mΩ at $V_{GS} = -10$ V, $I_D = -21.1$ A
- Max $r_{DS(on)}$ = 5.0 mΩ at $V_{GS} = -4.5$ V, $I_D = -15.7$ A
- Advanced Package and Silicon Combination for Low $r_{DS(on)}$
- HBM ESD Protection Level of 8 kV Typical (Note 3)
- MSL1 Robust Package Design
- RoHS Compliant

Applications

- Load Switch in Notebook and Server
- Notebook Battery Pack Power Management

MOSFET MAXIMUM RATINGS ($T_A = 25^\circ\text{C}$ unless otherwise noted)

| Symbol | Parameter | Ratings | Unit |
|----------------------|--|-------------|------------------|
| V_{DS} | Drain to Source Voltage | -30 | V |
| V_{GS} | Gate to Source Voltage | ±25 | V |
| I_D | Drain Current – Continuous $T_C = 25^\circ\text{C}$ (Note 5) | -122 | A |
| | – Continuous $T_C = 100^\circ\text{C}$ (Note 5) | -77 | |
| | – Continuous $T_A = 25^\circ\text{C}$ (Note 1a) | -21.1 | |
| | – Pulsed (Note 4) | -600 | |
| P_D | Power dissipation $T_C = 25^\circ\text{C}$ | 73 | W |
| | Power dissipation $T_A = 25^\circ\text{C}$ (Note 1a) | 2.5 | |
| T_J , T_{STG} | Operating and Storage Junction Temperature Range | -55 to +150 | $^\circ\text{C}$ |

Stresses exceeding those listed in the Maximum Ratings table may damage the device. If any of these limits are exceeded, device functionality should not be assumed, damage may occur and reliability may be affected.

THERMAL CHARACTERISTICS

| Symbol | Parameter | Ratings | Unit |
|-----------------|---|---------|---------------------------|
| $R_{\theta JC}$ | Thermal Resistance, Junction to Case | 1.7 | $^\circ\text{C}/\text{W}$ |
| $R_{\theta JA}$ | Thermal Resistance, Junction to Ambient (Note 1a) | 50 | |



ON Semiconductor[®]

www.onsemi.com

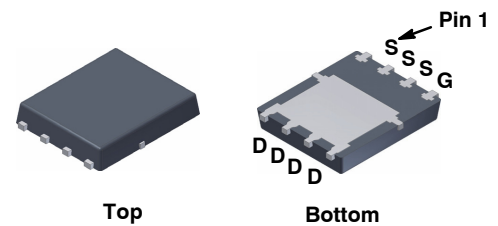
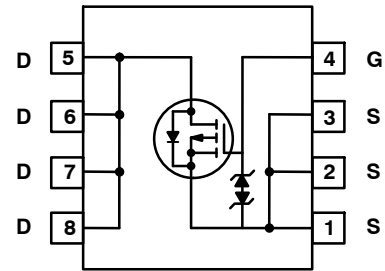

Power 56 (PQFN8)
CASE 483AE

MARKING DIAGRAM

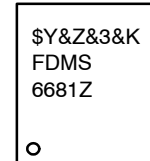

\$Y = ON Semiconductor Logo
 &Z = Assembly Plant Code
 &3 = Numeric Date Code
 &K = Lot Code
 FDMS6681Z = Specific Device Code

ORDERING INFORMATION

See detailed ordering and shipping information on page 2 of this data sheet.

FDMS6681Z

PACKAGE MARKING AND ORDERING INFORMATION

| Device Marking | Device | Package | Shipping† |
|----------------|-----------|----------|------------------------|
| FDMS6681Z | FDMS6681Z | Power 56 | 3000 Units/Tape & Reel |

†For information on tape and reel specifications, including part orientation and tape sizes, please refer to our Tape and Reel Packaging Specifications Brochure, BRD8011/D.

ELECTRICAL CHARACTERISTICS (T_J = 25°C unless otherwise noted)

| Symbol | Parameter | Test Conditions | Min | Typ | Max | Unit |
|--------|-----------|-----------------|-----|-----|-----|------|
|--------|-----------|-----------------|-----|-----|-----|------|

OFF CHARACTERISTICS

| | | | | | | |
|--------------------------------------|---|---|-----|----|-----|-------|
| BV _{DSS} | Drain to Source Breakdown Voltage | I _D = -250 μA, V _{GS} = 0 V | -30 | | | V |
| $\frac{\Delta BV_{DSS}}{\Delta T_J}$ | Breakdown Voltage Temperature Coefficient | I _D = -250 μA, referenced to 25°C | | 20 | | mV/°C |
| I _{DSS} | Zero Gate Voltage Drain Current | V _{DS} = -24 V, V _{GS} = 0 V | | | -1 | μA |
| I _{GSS} | Gate to Source Leakage Current | V _{GS} = ±25 V, V _{DS} = 0 V | | | ±10 | μA |

ON CHARACTERISTICS

| | | | | | | |
|--|--|---|----|------|-----|-------|
| V _{GS(th)} | Gate to Source Threshold Voltage | V _{GS} = V _{DS} , I _D = -250 μA | -1 | -1.7 | -3 | V |
| $\frac{\Delta V_{GS(th)}}{\Delta T_J}$ | Gate to Source Threshold Voltage Temperature Coefficient | I _D = -250 μA, referenced to 25°C | | -7 | | mV/°C |
| r _{DS(on)} | Static Drain to Source On Resistance | V _{GS} = -10 V, I _D = -22.1 A | | 2.7 | 3.2 | mΩ |
| | | V _{GS} = -4.5 V, I _D = -15.7 A | | 4.0 | 5.0 | |
| | | V _{GS} = -10 V, I _D = -22.1 A, T _J = 125°C | | 3.9 | 5.0 | |
| g _{FS} | Forward Transconductance | V _{DD} = -10 V, I _D = -22.1 A | | 143 | | S |

DYNAMIC CHARACTERISTICS

| | | | | | | |
|------------------|------------------------------|--|--|------|-------|----|
| C _{iss} | Input Capacitance | V _{DS} = -15 V, V _{GS} = 0 V, f = 1MHz | | 7803 | 10380 | pF |
| C _{oss} | Output Capacitance | | | 1540 | 2050 | |
| C _{rss} | Reverse Transfer Capacitance | | | 1345 | 2020 | |

SWITCHING CHARACTERISTICS

| | | | | | | |
|---------------------|-------------------------------|--|---|-----|-----|----|
| t _{d(on)} | Turn – On Delay Time | V _{DD} = -15 V, I _D = -22.1 A, V _{GS} = -10 V, R _{GEN} = 6 Ω | | 15 | 24 | ns |
| t _r | Rise Time | | | 38 | 61 | |
| t _{d(off)} | Turn – Off Delay Time | | | 260 | 416 | |
| t _f | Fall Time | | | 197 | 316 | |
| Q _g | Total Gate Charge | V _{GS} = 0 V to -10 V | V _{DD} = -15 V, I _D = -22.1 A | 172 | 241 | nC |
| Q _g | Total Gate Charge | V _{GS} = 0 V to -5 V | | 97 | 136 | |
| Q _{gs} | Gate to Source Charge | | | 22 | | |
| Q _{gd} | Gate to Drain “Miller” Charge | | | 46 | | |

DRAIN-SOURCE DIODE CHARACTERISTICS

| | | | | | | |
|-----------------|---------------------------------------|--|--|------|------|----|
| V _{SD} | Source to Drain Diode Forward Voltage | V _{GS} = 0 V, I _S = -2.1 A (Note 2) | | 0.68 | 1.2 | V |
| | | V _{GS} = 0 V, I _S = -22.1 A (Note 2) | | 0.79 | 1.25 | |
| t _{rr} | Reverse Recovery Time | I _F = -22.1 A, di/dt = 100 A/μs | | 44 | 71 | ns |
| Q _{rr} | Reverse Recovery Charge | | | 39 | 63 | nC |

Product parametric performance is indicated in the Electrical Characteristics for the listed test conditions, unless otherwise noted. Product performance may not be indicated by the Electrical Characteristics if operated under different conditions.

NOTES:

1. $R_{\theta JA}$ is determined with the device mounted on a 1 in² pad 2 oz copper pad on a 1.5 × 1.5 in. board of FR-4 material. $R_{\theta JC}$ is guaranteed by design while $R_{\theta CA}$ is determined by the user's board design.

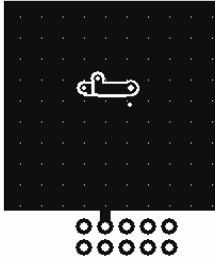

a) 50°C/W when mounted on a 1 in² pad of 2 oz copper.



b) 125°C/W when mounted on a minimum pad of 2 oz copper.

2. Pulse Test: Pulse Width < 300 μs, Duty cycle < 2.0%.
3. The diode connected between the gate and source serves only as protection against ESD. No gate overvoltage rating is implied.
4. Pulsed I_D please refer to Figure 12 SOA graph for more details.
5. Computed continuous current limited to Max Junction Temperature only, actual continuous current will be limited by thermal electro-mechanical application board design.

TYPICAL CHARACTERISTICS $T_J = 25^\circ\text{C}$ unless otherwise noted

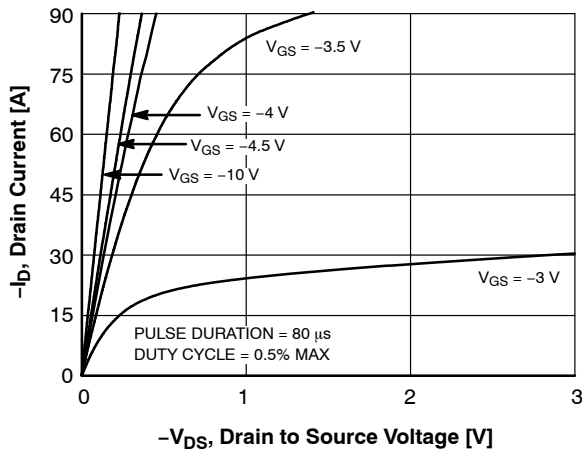

Figure 1. On Region Characteristics

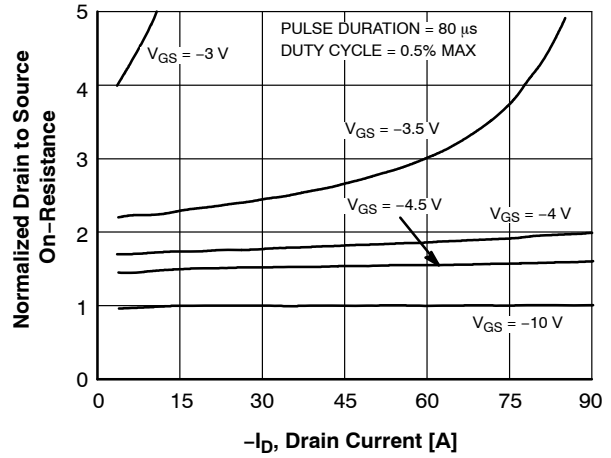

Figure 2. Normalized On-Resistance vs. Drain Current and Gate Voltage

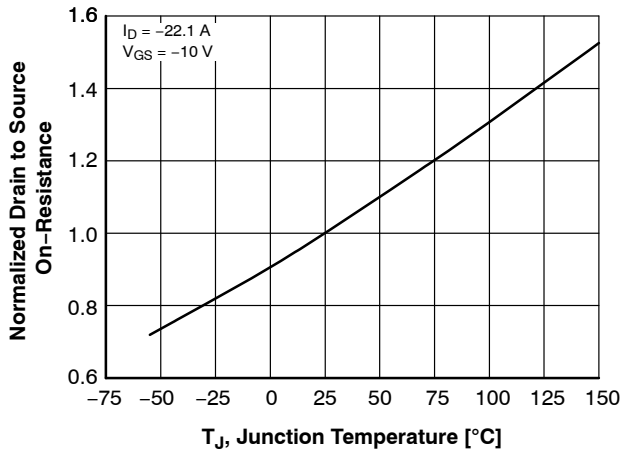

Figure 3. Normalized On Resistance vs. Junction Temperature

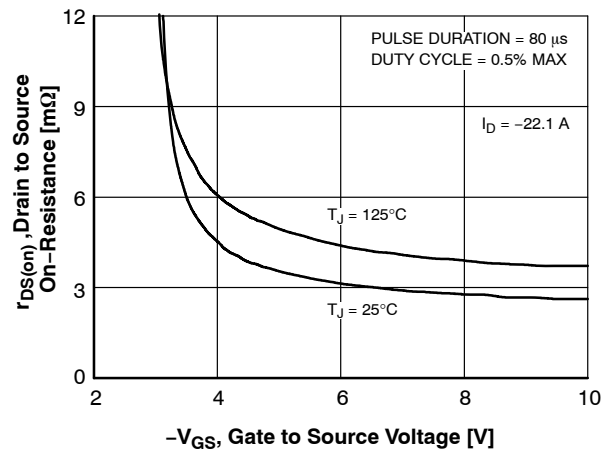

Figure 4. On-Resistance vs. Gate to Source Voltage

TYPICAL CHARACTERISTICS $T_J = 25^\circ\text{C}$ unless otherwise noted (continued)

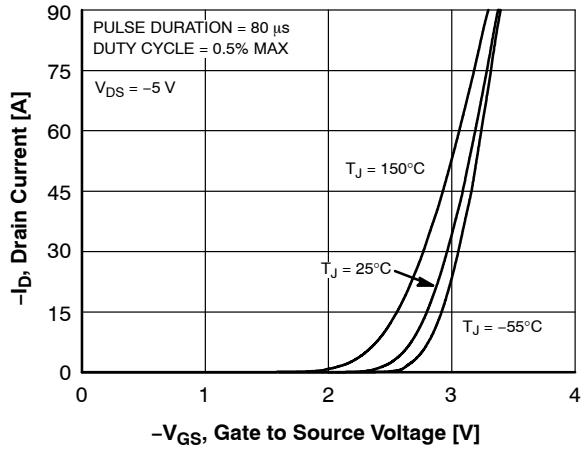

Figure 5. Transfer Characteristics

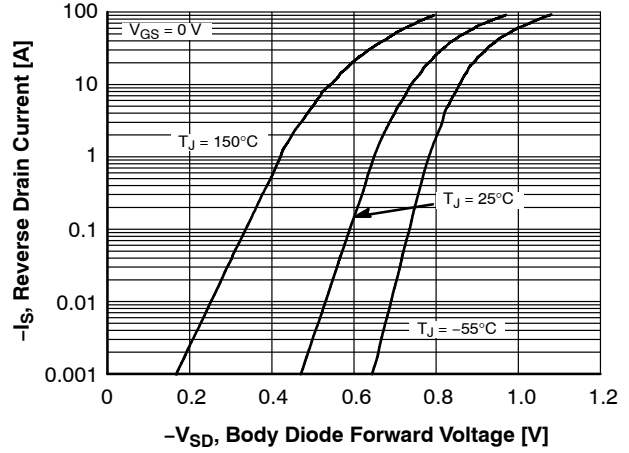

Figure 6. Source to Drain Diode Forward Voltage vs. Source Current

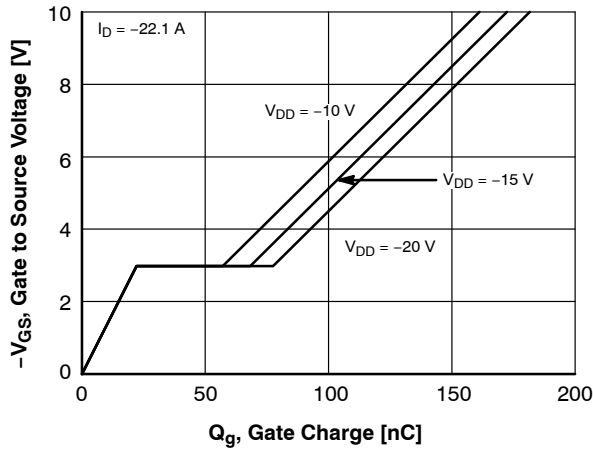

Figure 7. Gate Charge Characteristics

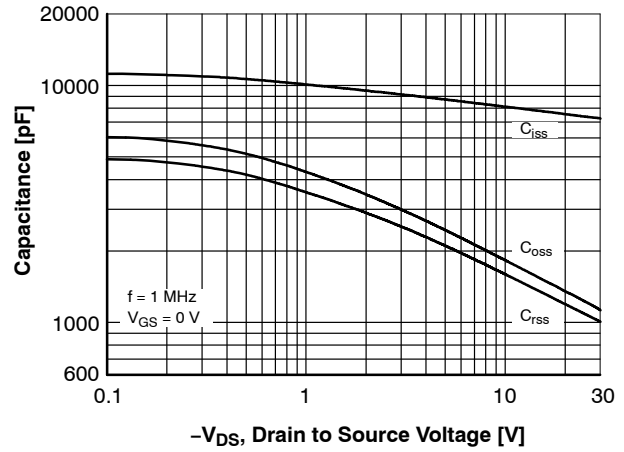

Figure 8. Capacitance vs. Drain to Source Voltage

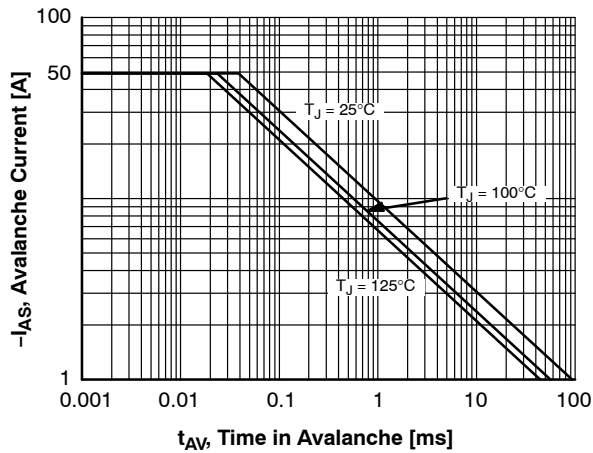

Figure 9. Unclamped Inductive Switching Capability

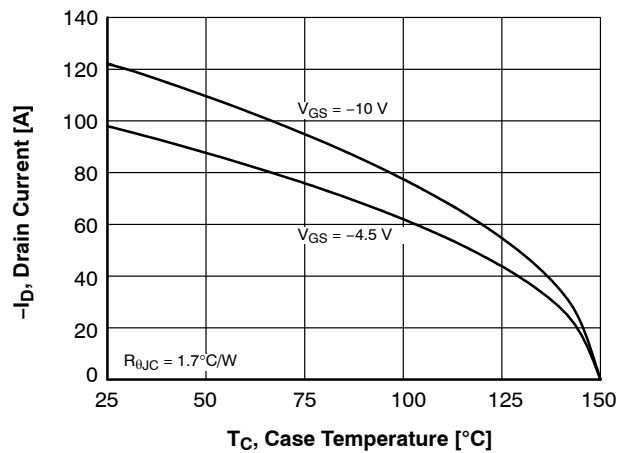

Figure 10. Maximum Continuous Drain Current vs. Case Temperature

TYPICAL CHARACTERISTICS $T_J = 25^\circ\text{C}$ unless otherwise noted (continued)

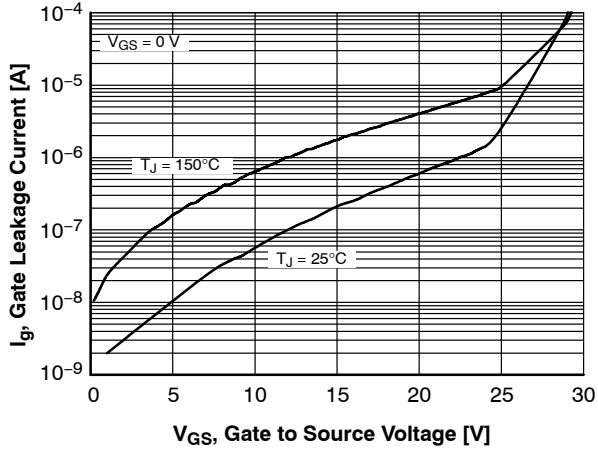

Figure 11. I_{gss} vs. V_{gss}

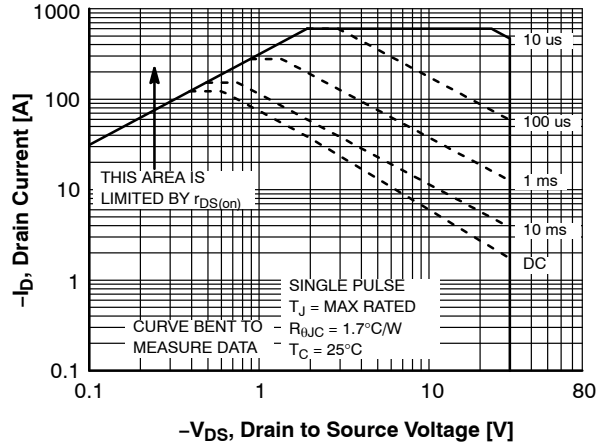

Figure 12. Forward Bias Safe Operating Area

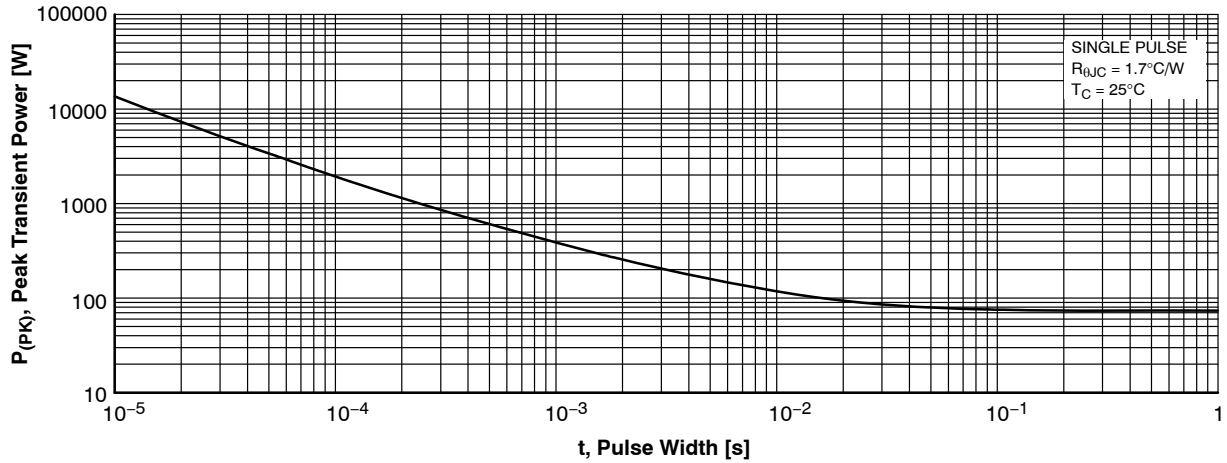

Figure 13. Single Pulse Maximum Power Dissipation

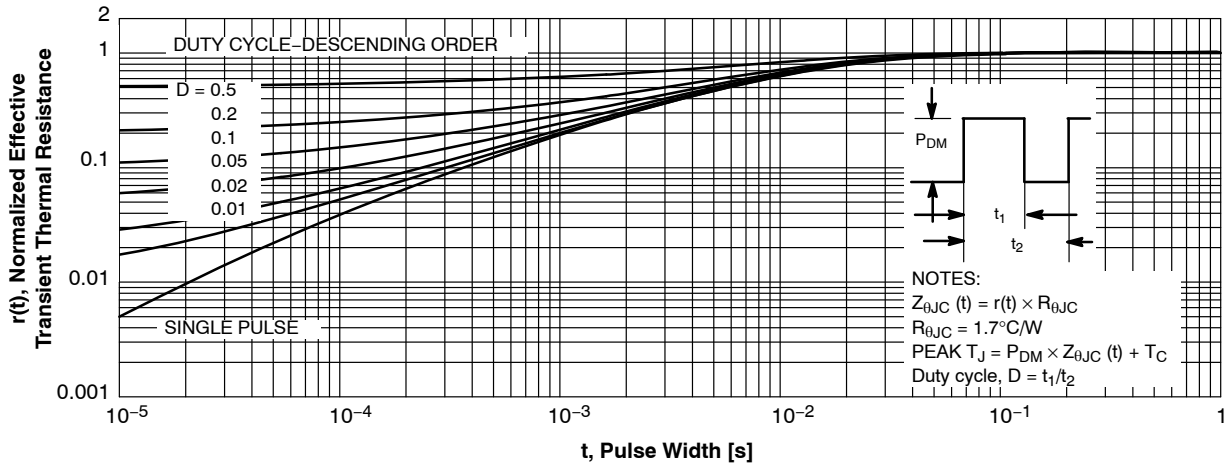

Figure 14. Transient Thermal Response Curve

POWERTRENCH is registered trademarks of Semiconductor Components Industries, LLC (SCILLC) or its subsidiaries in the United States and/or other countries.

MECHANICAL CASE OUTLINE PACKAGE DIMENSIONS



PQFN8 5X6, 1.27P
CASE 483AE
ISSUE C

DATE 21 JAN 2022



NOTES:

1. DIMENSIONING AND TOLERANCING PER ASME Y14.5M, 2009.
2. CONTROLLING DIMENSION: MILLIMETERS
3. COPLANARITY APPLIES TO THE EXPOSED PADS AS WELL AS THE TERMINALS.
4. DIMENSIONS D1 AND E1 DO NOT INCLUDE MOLD FLASH, PROTRUSIONS, OR GATE BURRS.
5. SEATING PLANE IS DEFINED BY THE TERMINALS. "A1" IS DEFINED AS THE DISTANCE FROM THE SEATING PLANE TO THE LOWEST POINT ON THE PACKAGE BODY.
6. IT IS RECOMMENDED TO HAVE NO TRACES OR VIAS WITHIN THE KEEP OUT AREA.

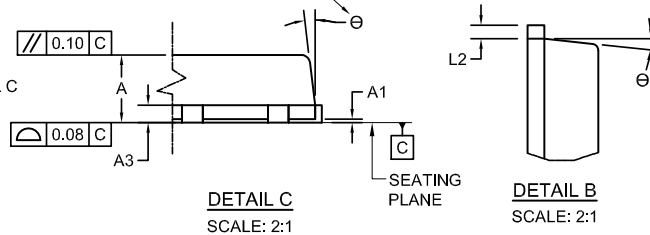
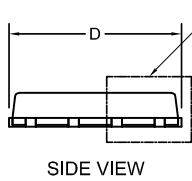

| DIM | MILLIMETERS | | |
|-----|-------------|------|------|
| | MIN. | NOM. | MAX. |
| A | 0.90 | 1.00 | 1.10 |
| A1 | 0.00 | - | 0.05 |
| b | 0.21 | 0.31 | 0.41 |
| b1 | 0.31 | 0.41 | 0.51 |
| A3 | 0.15 | 0.25 | 0.35 |
| D | 4.90 | 5.00 | 5.20 |
| D1 | 4.80 | 4.90 | 5.00 |
| D2 | 3.61 | 3.82 | 3.96 |
| E | 5.90 | 6.15 | 6.25 |
| E1 | 5.70 | 5.80 | 5.90 |
| E2 | 3.38 | 3.48 | 3.78 |
| E3 | 0.30 REF | | |
| E4 | 0.52 REF | | |
| e | 1.27 BSC | | |
| e/2 | 0.635 BSC | | |
| e1 | 3.81 BSC | | |
| e2 | 0.50 REF | | |
| L | 0.51 | 0.66 | 0.76 |
| L2 | 0.05 | 0.18 | 0.30 |
| L4 | 0.34 | 0.44 | 0.54 |
| z | 0.34 REF | | |
| θ | 0° | - | 12° |

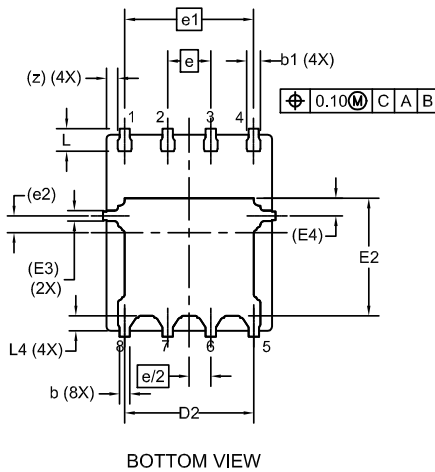

*FOR ADDITIONAL INFORMATION ON OUR PB-FREE STRATEGY AND SOLDERING DETAILS, PLEASE DOWNLOAD THE ON SEMICONDUCTOR SOLDERING AND MOUNTING TECHNIQUES REFERENCE MANUAL, SOLDERRM/D.

| | | |
|-------------------------|-------------------------|--|
| DOCUMENT NUMBER: | 98AON13655G | Electronic versions are uncontrolled except when accessed directly from the Document Repository. Printed versions are uncontrolled except when stamped "CONTROLLED COPY" in red. |
| DESCRIPTION: | PQFN8 5X6, 1.27P | PAGE 1 OF 1 |

onsemi and ONSEMI are trademarks of Semiconductor Components Industries, LLC dba onsemi or its subsidiaries in the United States and/or other countries. onsemi reserves the right to make changes without further notice to any products herein. onsemi makes no warranty, representation or guarantee regarding the suitability of its products for any particular purpose, nor does onsemi assume any liability arising out of the application or use of any product or circuit, and specifically disclaims any and all liability, including without limitation special, consequential or incidental damages. onsemi does not convey any license under its patent rights nor the rights of others.

onsemi, **Onsemi**, and other names, marks, and brands are registered and/or common law trademarks of Semiconductor Components Industries, LLC dba "**onsemi**" or its affiliates and/or subsidiaries in the United States and/or other countries. **onsemi** owns the rights to a number of patents, trademarks, copyrights, trade secrets, and other intellectual property. A listing of **onsemi**'s product/patent coverage may be accessed at www.onsemi.com/site/pdf/Patent-Marking.pdf. **onsemi** reserves the right to make changes at any time to any products or information herein, without notice. The information herein is provided "as-is" and **onsemi** makes no warranty, representation or guarantee regarding the accuracy of the information, product features, availability, functionality, or suitability of its products for any particular purpose, nor does **onsemi** assume any liability arising out of the application or use of any product or circuit, and specifically disclaims any and all liability, including without limitation special, consequential or incidental damages. Buyer is responsible for its products and applications using **onsemi** products, including compliance with all laws, regulations and safety requirements or standards, regardless of any support or applications information provided by **onsemi**. "Typical" parameters which may be provided in **onsemi** data sheets and/or specifications can and do vary in different applications and actual performance may vary over time. All operating parameters, including "Typicals" must be validated for each customer application by customer's technical experts. **onsemi** does not convey any license under any of its intellectual property rights nor the rights of others. **onsemi** products are not designed, intended, or authorized for use as a critical component in life support systems or any FDA Class 3 medical devices or medical devices with a same or similar classification in a foreign jurisdiction or any devices intended for implantation in the human body. Should Buyer purchase or use **onsemi** products for any such unintended or unauthorized application, Buyer shall indemnify and hold **onsemi** and its officers, employees, subsidiaries, affiliates, and distributors harmless against all claims, costs, damages, and expenses, and reasonable attorney fees arising out of, directly or indirectly, any claim of personal injury or death associated with such unintended or unauthorized use, even if such claim alleges that **onsemi** was negligent regarding the design or manufacture of the part. **onsemi** is an Equal Opportunity/Affirmative Action Employer. This literature is subject to all applicable copyright laws and is not for resale in any manner.

ADDITIONAL INFORMATION

TECHNICAL PUBLICATIONS:

Technical Library: www.onsemi.com/design/resources/technical-documentation
onsemi Website: www.onsemi.com

ONLINE SUPPORT: www.onsemi.com/support

For additional information, please contact your local Sales Representative at www.onsemi.com/support/sales