

MOSFET – N-Channel, UltraFET Trench

80 V, 22 A, 16.5 mΩ

FDMS3572

General Description

UltraFET devices combine characteristics that enable benchmark efficiency in power conversion applications. Optimized for $R_{DS(on)}$, low ESR, low total and Miller gate charge, these devices are ideal for high frequency DC to DC converters.

Features

- Max $R_{DS(on)}$ = 16.5 mΩ at $V_{GS} = 10\text{ V}$, $I_D = 8.8\text{ A}$
- Max $R_{DS(on)}$ = 24 mΩ at $V_{GS} = 6\text{ V}$, $I_D = 8.4\text{ A}$
- Typ Qg = 28 nC at $V_{GS} = 10\text{ V}$
- Low Miller Charge
- Optimized Efficiency at High Frequencies
- Pb-Free, Halide Free and RoHS Compliant

Applications

- DC – DC Conversion

MAXIMUM RATINGS ($T_A = 25^\circ\text{C}$ unless otherwise noted)

Symbol	Parameter	Value	Unit
V_{DS}	Drain to Source Voltage	80	V
V_{GS}	Gate to Source Voltage	±20	V
I_D	Drain Current: – Continuous (Package limited) $T_C = 25^\circ\text{C}$ – Continuous (Silicon limited) $T_C = 25^\circ\text{C}$ – Continuous $T_A = 25^\circ\text{C}$ (Note 1a) – Pulsed	22 48 8.8 50	A
P_D	Power Dissipation: $T_C = 25^\circ\text{C}$ $T_A = 25^\circ\text{C}$ (Note 1a)	78 2.5	W
T_J, T_{STG}	Operating and Storage Junction Temperature Range	–55 to +150	°C

Stresses exceeding those listed in the Maximum Ratings table may damage the device. If any of these limits are exceeded, device functionality should not be assumed, damage may occur and reliability may be affected.

THERMAL CHARACTERISTICS

Symbol	Parameter	Value	Unit
$R_{\theta JC}$	Thermal Resistance, Junction to Case	1.6	°C/W
$R_{\theta JA}$	Thermal Resistance, Junction to Ambient (Note 1a)	50	

V_{DS}	$R_{DS(on)}$ MAX	I_D MAX
80 V	16.5 mΩ @ 10 V	22 A
	24 mΩ @ 6 V	

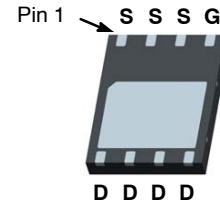

Bottom View

WDFN8 5×6, 1.27P
(Power 56)
CASE 506DP

ELECTRICAL CONNECTION

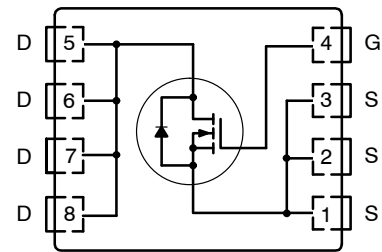

N-CHANNEL MOSFET

MARKING DIAGRAM

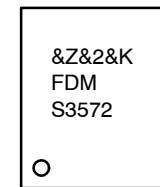

- &Z = Assembly Plant Code
- &2 = 2-Digit Date Code (Year and Week)
- &K = 2-Digit Lot Run Code
- FDMS3572 = Specific Device Code

ORDERING INFORMATION

Device	Package	Shipping†
FDMS3572	WDFN8 5×6, 1.27P (Power 56) (Pb-Free, Halide Free)	3000 / Tape & Reel

†For information on tape and reel specifications, including part orientation and tape sizes, please refer to our Tape and Reel Packaging Specification Brochure, [BRD8011/D](#).

ELECTRICAL CHARACTERISTICS ($T_J = 25^\circ\text{C}$ unless otherwise noted)

Symbol	Parameter	Test Condition	Min	Typ	Max	Unit
BV_{DSS}	Drain to Source Breakdown Voltage	$I_D = 250\ \mu\text{A}, V_{GS} = 0\ \text{V}$	80	-	-	V
$\frac{\Delta BV_{DSS}}{\Delta T_J}$	Breakdown Voltage Temperature Coefficient	$I_D = 250\ \mu\text{A}$, Referenced to 25°C	-	76	-	mV/ $^\circ\text{C}$
I_{DSS}	Zero Gate Voltage Drain Current	$V_{DS} = 64\ \text{V}, V_{GS} = 0\ \text{V}$	-	-	1	μA
I_{GSS}	Gate to Source Leakage Current	$V_{GS} = \pm 20\ \text{V}, V_{DS} = 0\ \text{V}$	-	-	± 100	nA

ON CHARACTERISTICS (Note 2)

$V_{GS(th)}$	Gate to Source Threshold Voltage	$V_{GS} = V_{DS}, I_D = 250\ \mu\text{A}$	2	3.2	4	V
$\frac{\Delta V_{GS(th)}}{\Delta T_J}$	Gate to Source Threshold Voltage Temperature Coefficient	$I_D = 250\ \mu\text{A}$, Referenced to 25°C	-	-11	-	mV/ $^\circ\text{C}$
$R_{DS(on)}$	Drain to Source On Resistance	$V_{GS} = 10\ \text{V}, I_D = 8.8\ \text{A}$	-	13.5	16.5	m Ω
		$V_{GS} = 6\ \text{V}, I_D = 8.4\ \text{A}$	-	18.3	24	
		$V_{GS} = 10\ \text{V}, I_D = 8.8\ \text{A}, T_J = 125^\circ\text{C}$	-	22.2	29	
g_{FS}	Forward Transconductance	$V_{DS} = 10\ \text{V}, I_D = 8.8\ \text{A}$	-	23	-	S

DYNAMIC CHARACTERISTICS

C_{iss}	Input Capacitance	$V_{DS} = 40\ \text{V}, V_{GS} = 0\ \text{V}, f = 1\ \text{MHz}$	-	1870	2490	pF
C_{oss}	Output Capacitance		-	275	365	pF
C_{rss}	Reverse Transfer Capacitance		-	78	120	pF
R_g	Gate Resistance	$f = 1\ \text{MHz}$	-	1.3	-	Ω

SWITCHING CHARACTERISTICS

$t_{d(on)}$	Turn-On Delay Time	$V_{DD} = 40\ \text{V}, I_D = 8.8\ \text{A}, V_{GS} = 10\ \text{V}, R_{GEN} = 6\ \Omega$	-	11	20	ns
t_r	Rise Time		-	13	24	ns
$t_{d(off)}$	Turn-Off Delay Time		-	24	39	ns
t_f	Fall Time		-	12	22	ns
$Q_g(TOT)$	Total Gate Charge at 10 V	$V_{GS} = 0\ \text{V}$ to $10\ \text{V}, V_{DD} = 40\ \text{V}, I_D = 8.8\ \text{A}$	-	28	40	nC
Q_{gs}	Gate to Source Gate Charge	$V_{DD} = 40\ \text{V}, I_D = 8.8\ \text{A}$	-	9	-	nC
Q_{gd}	Gate to Drain "Miller" Charge	$V_{DD} = 40\ \text{V}, I_D = 8.8\ \text{A}$	-	8	-	nC

DRAIN-SOURCE DIODE CHARACTERISTICS

V_{SD}	Source to Drain Diode Forward Voltage	$V_{GS} = 0\ \text{V}, I_S = 8.8\ \text{A}$ (Note 2)	-	0.8	1.2	V
t_{rr}	Reverse Recovery Time	$I_F = 8.8\ \text{A}, di/dt = 100\ \text{A}/\mu\text{s}$	-	43	65	ns
Q_{rr}	Reverse Recovery Charge		-	71	107	nC

Product parametric performance is indicated in the Electrical Characteristics for the listed test conditions, unless otherwise noted. Product performance may not be indicated by the Electrical Characteristics if operated under different conditions.

NOTES:

- $R_{\theta JA}$ is determined with the device mounted on a 1 in² pad 2 oz copper pad on a 1.5 x 1.5 in. board of FR-4 material. $R_{\theta JC}$ is guaranteed by design while $R_{\theta CA}$ is determined by the user's board design.

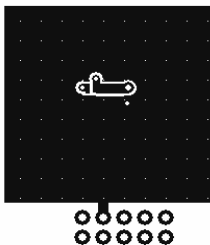

a) $50^\circ\text{C}/\text{W}$ when mounted on a 1 in² pad of 2 oz copper.

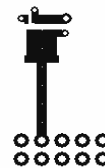

b) $125^\circ\text{C}/\text{W}$ when mounted on a minimum pad of 2 oz copper.

- Pulse Test: Pulse Width < 300 μs , Duty cycle < 2.0%.

TYPICAL CHARACTERISTICS

($T_J = 25^\circ\text{C}$ unless otherwise noted)

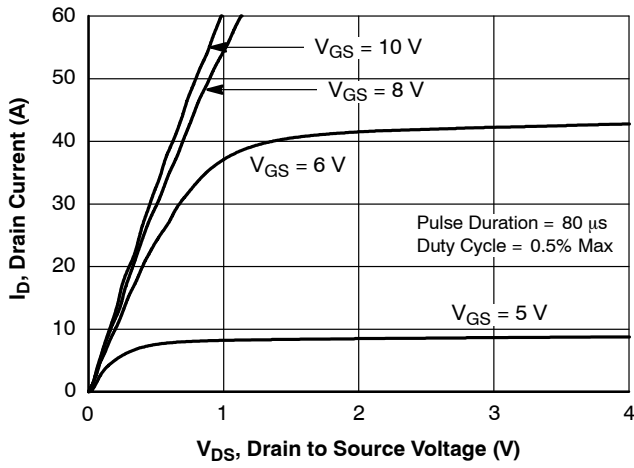

Figure 1. On Region Characteristics

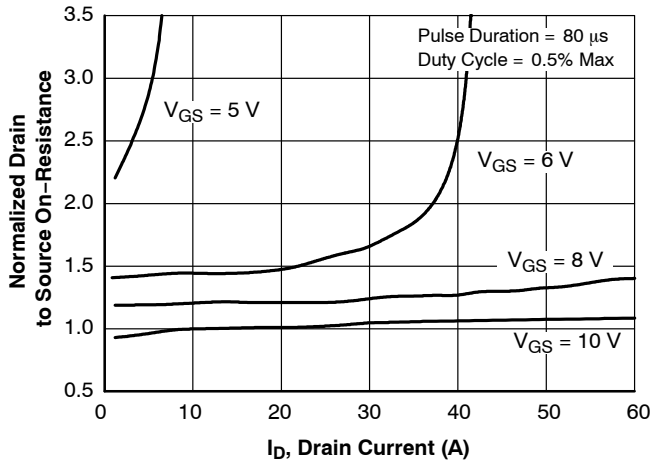

Figure 2. Normalized On-Resistance vs. Drain Current and Gate Voltage

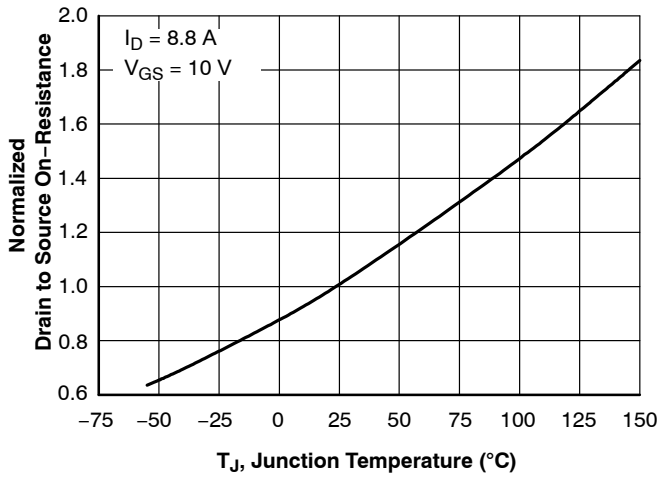

Figure 3. Normalized On Resistance vs. Junction Temperature

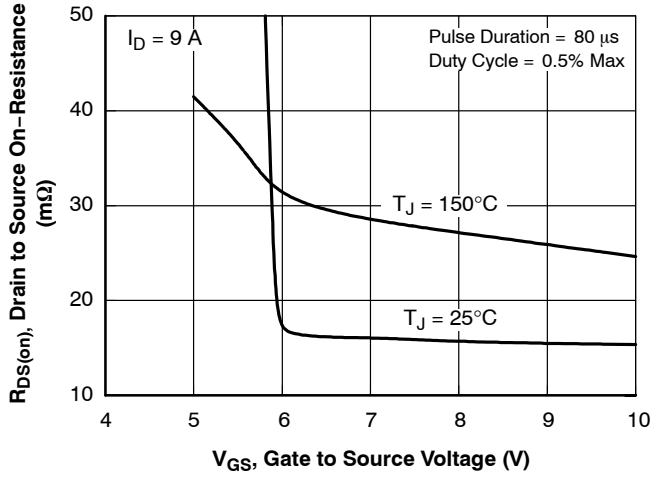

Figure 4. On-Resistance vs. Gate to Source Voltage

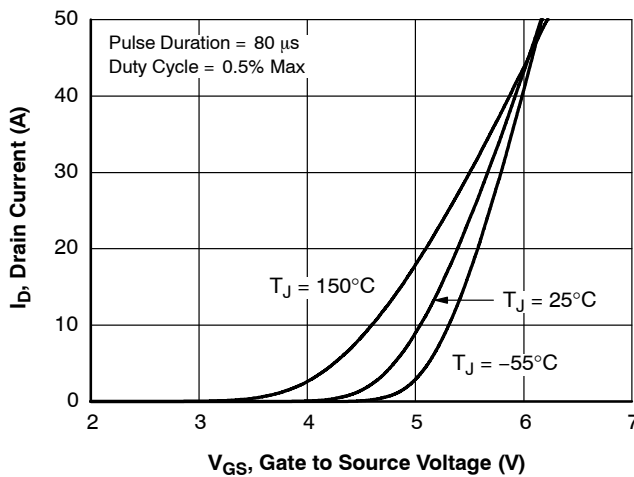

Figure 5. Transfer Characteristics

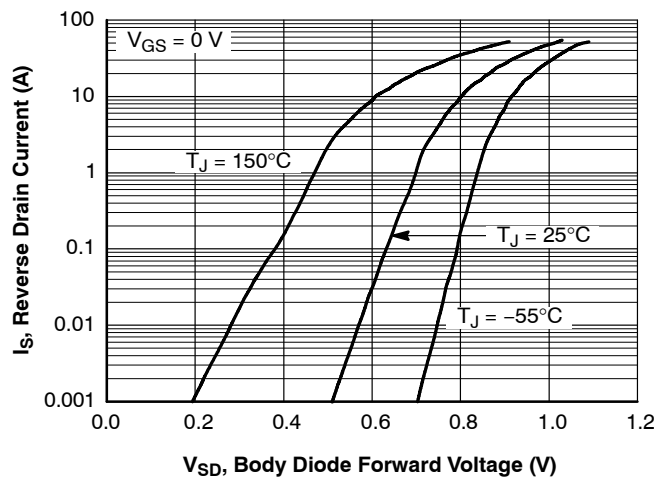

Figure 6. Source to Drain Diode Forward Voltage vs. Source Current

TYPICAL CHARACTERISTICS (continued)

($T_J = 25^\circ\text{C}$ unless otherwise noted)

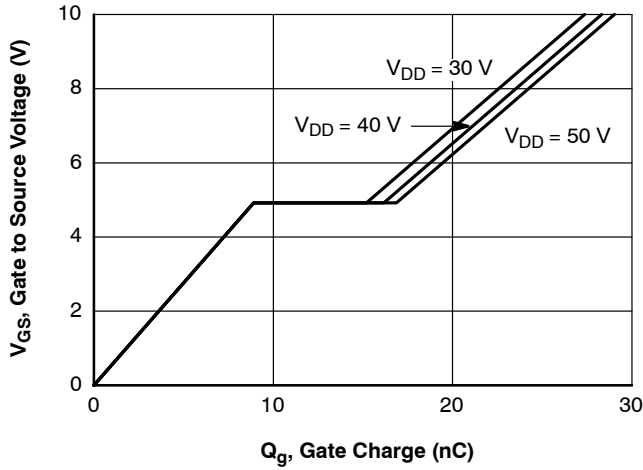

Figure 7. Gate Charge Characteristics

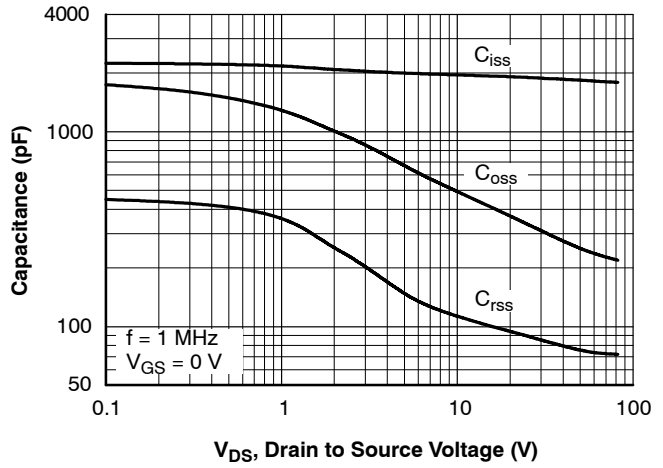

Figure 8. Capacitance vs. Drain to Source Voltage

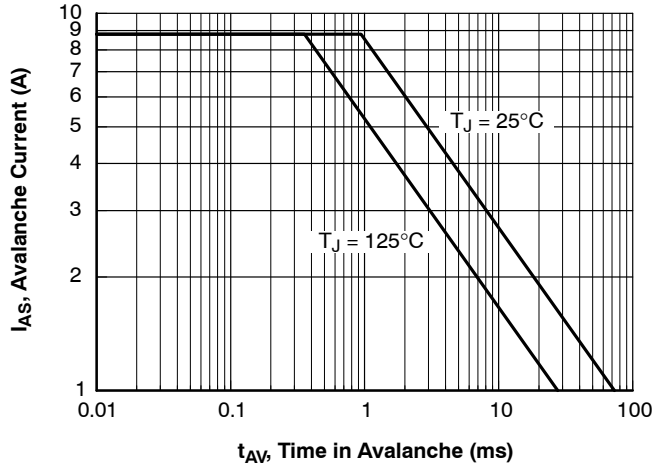

Figure 9. Unclamped Inductive Switching Capability

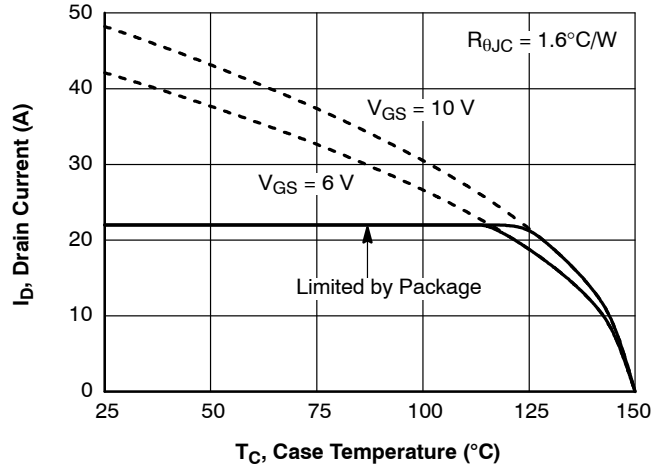

Figure 10. Maximum Continuous Drain Current vs. Case Temperature

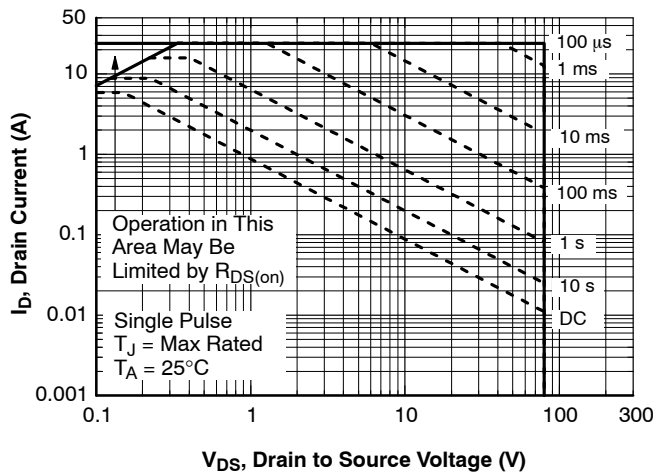

Figure 11. Forward Bias Safe Operating Area

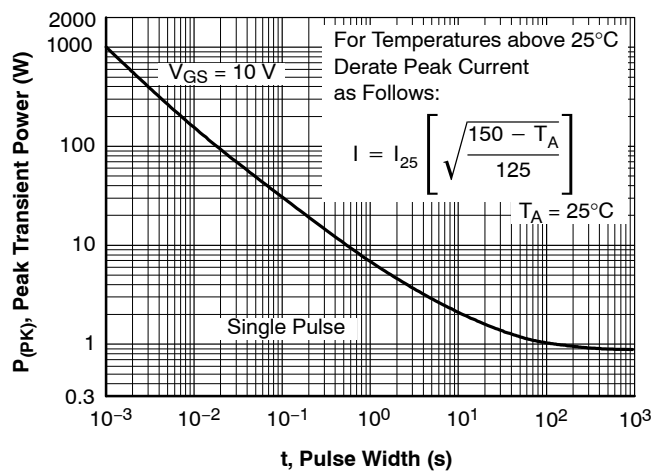

Figure 12. Single Pulse Maximum Power Dissipation

TYPICAL CHARACTERISTICS (continued)

($T_J = 25^\circ\text{C}$ unless otherwise noted)

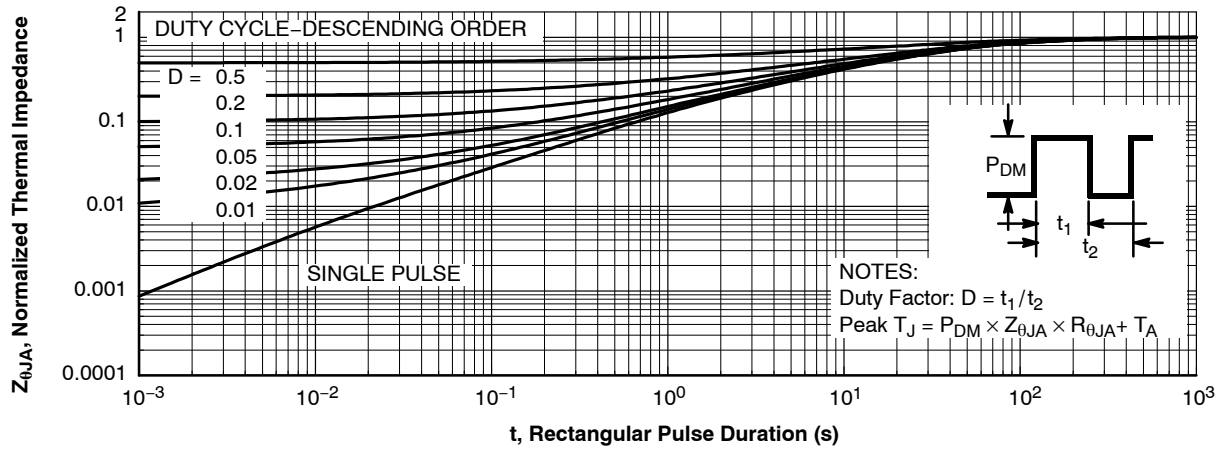

Figure 13. Transient Thermal Response Curve

MECHANICAL CASE OUTLINE

PACKAGE DIMENSIONS

ON Semiconductor®



WDFN8 5x6, 1.27P
CASE 506DP
ISSUE O

DATE 31 AUG 2016

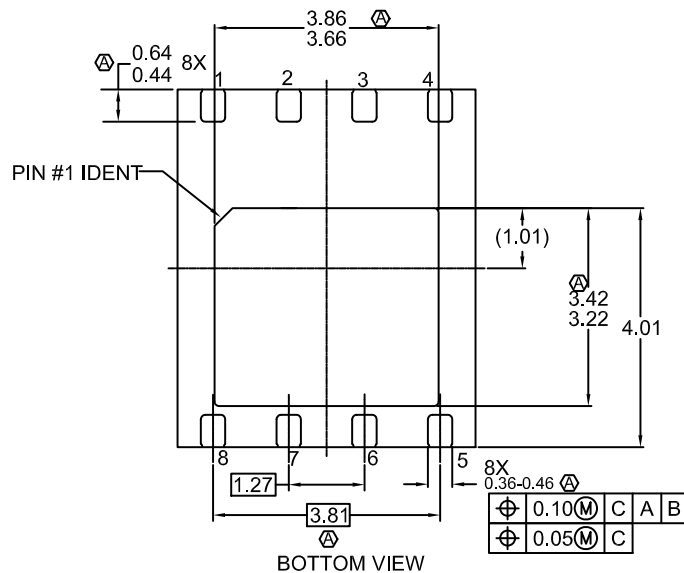
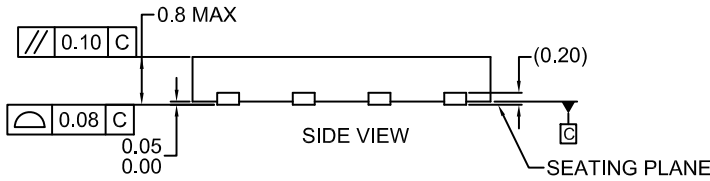
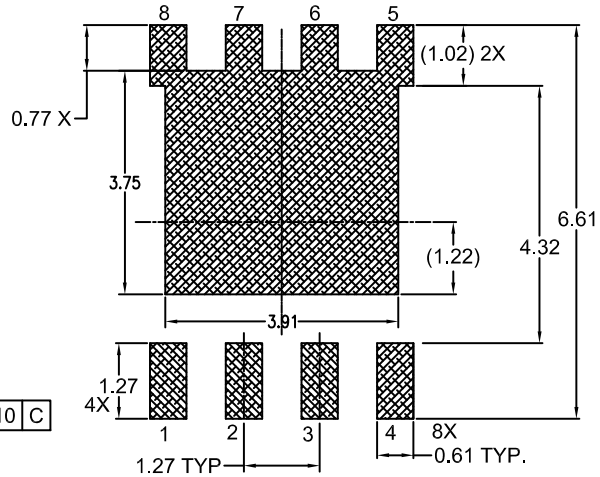
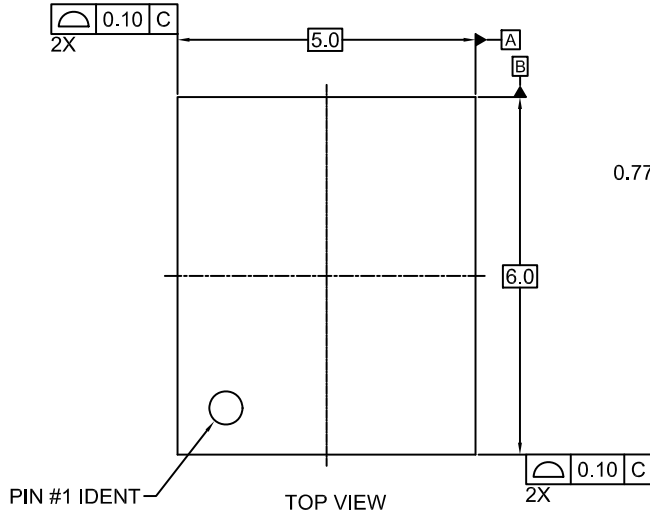

NOTES:

- Ⓐ DOES NOT FULLY CONFORM TO JEDEC REGISTRATION, MO-229.
- B. DIMENSIONS ARE IN MILLIMETERS.
- C. DIMENSIONS AND TOLERANCES PER ASME Y14.5M, 1994
- D. TERMINALS 5,6,7 AND 8 ARE TIED TO THE EXPOSED PADDLE

DOCUMENT NUMBER:	98AON13598G	Electronic versions are uncontrolled except when accessed directly from the Document Repository. Printed versions are uncontrolled except when stamped "CONTROLLED COPY" in red.
DESCRIPTION:	WDFN8 5X6, 1.27P	PAGE 1 OF 1

ON Semiconductor and are trademarks of Semiconductor Components Industries, LLC dba ON Semiconductor or its subsidiaries in the United States and/or other countries. ON Semiconductor reserves the right to make changes without further notice to any products herein. ON Semiconductor makes no warranty, representation or guarantee regarding the suitability of its products for any particular purpose, nor does ON Semiconductor assume any liability arising out of the application or use of any product or circuit, and specifically disclaims any and all liability, including without limitation special, consequential or incidental damages. ON Semiconductor does not convey any license under its patent rights nor the rights of others.

onsemi, **Onsemi**, and other names, marks, and brands are registered and/or common law trademarks of Semiconductor Components Industries, LLC dba "**onsemi**" or its affiliates and/or subsidiaries in the United States and/or other countries. **onsemi** owns the rights to a number of patents, trademarks, copyrights, trade secrets, and other intellectual property. A listing of **onsemi**'s product/patent coverage may be accessed at www.onsemi.com/site/pdf/Patent-Marking.pdf. **onsemi** reserves the right to make changes at any time to any products or information herein, without notice. The information herein is provided "as-is" and **onsemi** makes no warranty, representation or guarantee regarding the accuracy of the information, product features, availability, functionality, or suitability of its products for any particular purpose, nor does **onsemi** assume any liability arising out of the application or use of any product or circuit, and specifically disclaims any and all liability, including without limitation special, consequential or incidental damages. Buyer is responsible for its products and applications using **onsemi** products, including compliance with all laws, regulations and safety requirements or standards, regardless of any support or applications information provided by **onsemi**. "Typical" parameters which may be provided in **onsemi** data sheets and/or specifications can and do vary in different applications and actual performance may vary over time. All operating parameters, including "Typicals" must be validated for each customer application by customer's technical experts. **onsemi** does not convey any license under any of its intellectual property rights nor the rights of others. **onsemi** products are not designed, intended, or authorized for use as a critical component in life support systems or any FDA Class 3 medical devices or medical devices with a same or similar classification in a foreign jurisdiction or any devices intended for implantation in the human body. Should Buyer purchase or use **onsemi** products for any such unintended or unauthorized application, Buyer shall indemnify and hold **onsemi** and its officers, employees, subsidiaries, affiliates, and distributors harmless against all claims, costs, damages, and expenses, and reasonable attorney fees arising out of, directly or indirectly, any claim of personal injury or death associated with such unintended or unauthorized use, even if such claim alleges that **onsemi** was negligent regarding the design or manufacture of the part. **onsemi** is an Equal Opportunity/Affirmative Action Employer. This literature is subject to all applicable copyright laws and is not for resale in any manner.

ADDITIONAL INFORMATION

TECHNICAL PUBLICATIONS:

Technical Library: www.onsemi.com/design/resources/technical-documentation
onsemi Website: www.onsemi.com

ONLINE SUPPORT: www.onsemi.com/support

For additional information, please contact your local Sales Representative at www.onsemi.com/support/sales