

# GreenBridge™ 2 Series of High-Efficiency Bridge Rectifiers

## FDMQ8205

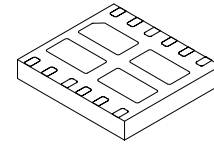

WDFN12 5x4.5, 0.8P  
CASE 511CS

### General Description

FDMQ8205 is GreenBridge 2 series of quad MOSFETs for a bridge application so that the input will be insensitive to the polarity of a power source coupled to the device. Many known bridge rectifier circuits can be configured using typical diodes. The conventional diode bridge has relatively high power loss that is undesirable in many applications. Especially, Power over Ethernet (PoE) Power Device (PD) application requires high-efficiency bridges because it should be operated with the limited power delivered from Power Source Equipment (PSE) which is classified by IEEE802.3at. FDMQ8205 is configured with low  $R_{DS(on)}$  dual P-ch MOSFETs and N-ch MOSFETs so that it can reduce the power loss caused by the voltage drop, compared to the conventional diode bridge. FDMQ8205 enables the application to maximize the available power and voltage and to eliminate the thermal design problems in PoE PD applications.

FDMQ8205 GreenBridge 2 is compatible with IEEE802.3at PoE standard by not compromising detection and classification requirement as well as small backfeed voltage.

### Features

- Low Power Loss GreenBridge Replaces Diode Bridge
- Self Driving Circuitry for MOSFETs
- Low  $R_{DS(on)}$  80 V Rated MOSFETs
- Maximizing Available Power and Voltage
- Eliminating Thermal Design Problems
- IEEE802.3at Compatible
  - ◆ Meet Detection and Classification Requirement
  - ◆ Work with 2 and 4-pair Architecture
  - ◆ Small Backfeed Voltage
- Compact MLP 4.5 x 5 Package
- These Device is Pb-Free and Halogen Free.

### Applications

- Power over Ethernet (PoE) Power Device (PD)
  - ◆ IP Phones
  - ◆ Network Cameras
  - ◆ Wireless Access Points
  - ◆ Thin Clients
  - ◆ Microcell
  - ◆ Femtocell

### MARKING DIAGRAM

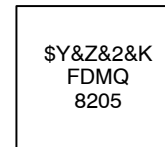

- FDMQ8205 = Specific Device Code  
\$Y = onsemi Logo  
&Z = Assembly plant code  
&2 = Date Code format (Year and Week)  
&K = Lot Run Traceability Code

### ORDERING INFORMATION

See detailed ordering and shipping information on page 9 of this data sheet.

# FDMQ8205

## TYPICAL APPLICATION

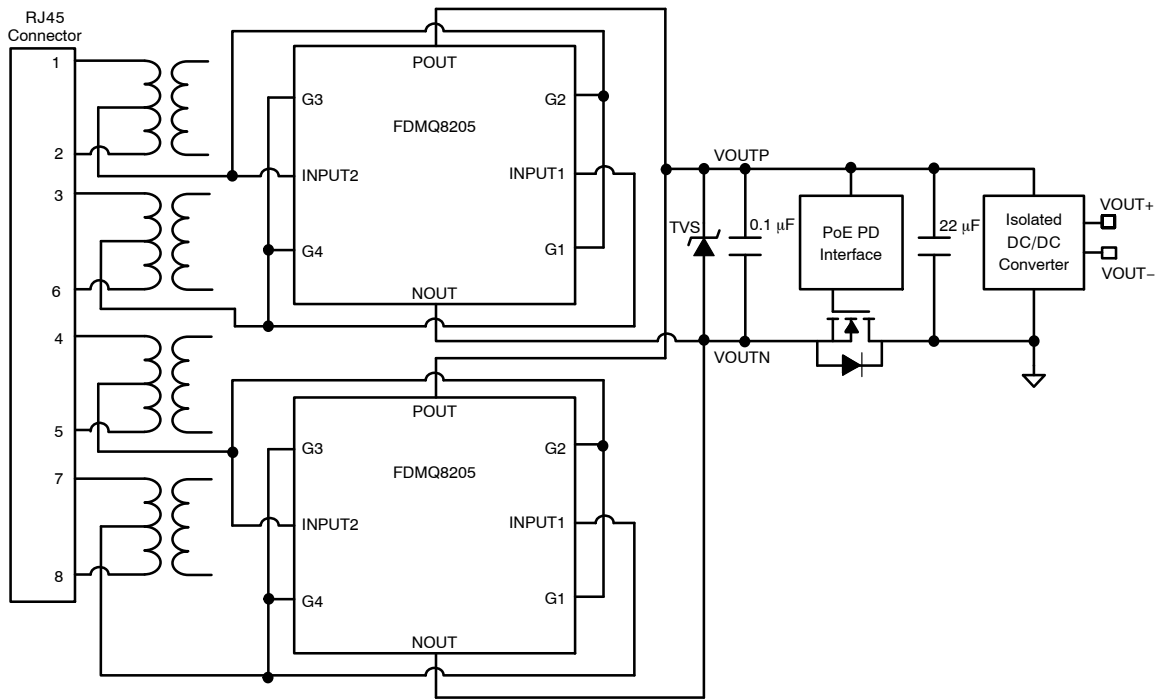

Figure 1. Typical Application of Power Device for Power over Ethernet

## BLOCK DIAGRAM

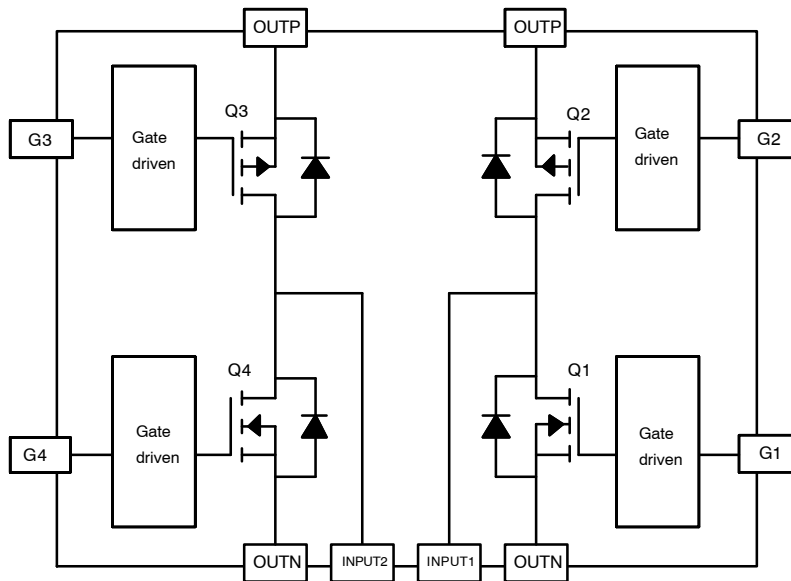
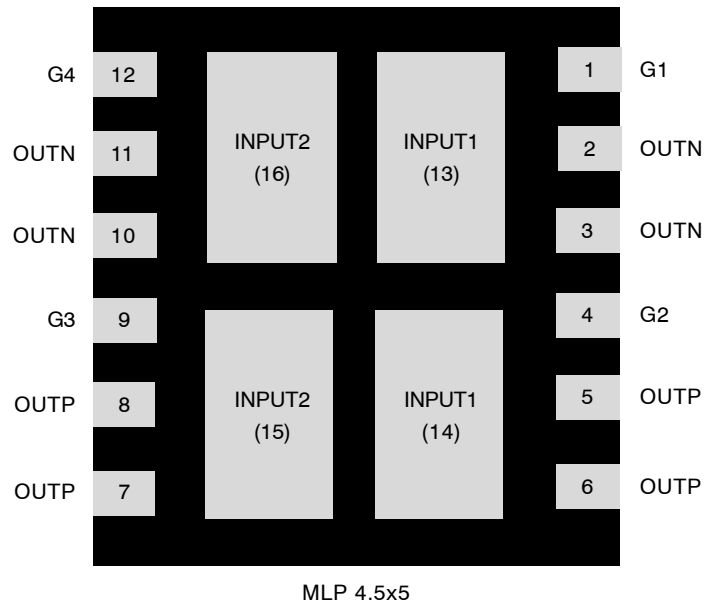

Figure 2. Block Diagram

# FDMQ8205

## PIN CONFIGURATION



**Figure 3. Pin Assignment (Bottom View)**

### PIN DESCRIPTION

Pin No.	Name	Description
1	G1	Gate of Q1 N-ch MOSFET
4	G2	Gate of Q2 P-ch MOSFET
9	G3	Gate of Q3 P-ch MOSFET
12	G4	Gate of Q4 N-ch MOSFET
13, 14	INPUT1	Input1 of GreenBridge
15, 16	INPUT2	Input2 of GreenBridge
2, 3, 11, 10	OUTN	Negative Output of GreenBridge
5, 6, 7, 8	OUTP	Positive Output of GreenBridge

1. Show the feature that provides orientation or pin 1 location.

**ABSOLUTE MAXIMUM RATINGS**

		Min	Max	Unit
INPUT1, INPUT2 to OUTN		-	80	V
OUTP to INPUT1, INPUT2		-	80	V
INPUT1 to INPUT2		-	80	V
INPUT2 to INPUT1		-	80	V
OUTP to OUTN		-	80	V
G1, G2, G3, G4 to OUTN		-	70	V
OUTP to G1, G2, G3, G4		-	70	V
VG_TRANSIENT	Transient Gate Voltage, Pulse Width < 200 $\mu$ s, Duty Cycle < 0.003%	-	100	V
Continuous $I_{INPUT}$ (GreenBridge Current, Q1 + Q3 or Q2 + Q4)	$T_A = 25^\circ\text{C}$ (Note 2a)	-	3.0	A
	$T_A = 25^\circ\text{C}$ (Note 2b)	-	1.7	A
Pulsed $I_{INPUT}$ (Q1 + Q3 or Q2 + Q4)	Pulse Width < 300 $\mu$ s, Duty Cycle < 2% (Note 3)	-	58	A
$P_D$ (Power Dissipation, Q1 + Q3 or Q2 + Q4)	$T_A = 25^\circ\text{C}$ (Note 2a)	-	2.5	W
	$T_A = 25^\circ\text{C}$ (Note 2b)	-	0.78	W
Max Junction Temperature		-	150	$^\circ\text{C}$

Stresses exceeding those listed in the Maximum Ratings table may damage the device. If any of these limits are exceeded, device functionality should not be assumed, damage may occur and reliability may be affected.

2.  $R_{\theta JA}$  is determined with the device mounted on a 1 in<sup>2</sup> pad 2 oz copper pad on a 1.5 x 1.5 in. board of FR-4 material.  $R_{\theta JC}$  is guaranteed by design while  $R_{\theta CA}$  is determined by the user's board design.

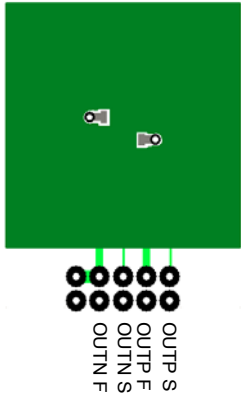

a. 50 $^\circ\text{C}/\text{W}$  when mounted on a 1 in<sup>2</sup> pad of 2 oz copper, the board designed Q1 + Q3 or Q2 + Q4.

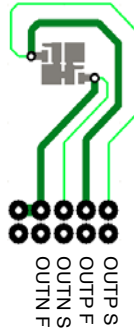

b. 160 $^\circ\text{C}/\text{W}$  when mounted on a minimum pad of 2 oz copper, the board designed Q1 + Q3 or Q2 + Q4.

3. Pulse Id measured at  $t_d \leq 300 \mu\text{s}$ , refer to SOA graph for more details.

**THERMAL CHARACTERISTICS**

Symbol	Parameter	Min	Typ	Max	Unit
$R_{\theta JC}$	Thermal Resistance, Junction to Case	-	5.1	-	$^\circ\text{C}/\text{W}$
$R_{\theta JA}$	Thermal Resistance, Junction to Ambient (Note 2a)	-	50	-	
$R_{\theta JA}$	Thermal Resistance, Junction to Ambient (Note 2b)	-	160	-	

# FDMQ8205

## RECOMMENDED OPERATING CONDITIONS

Symbol	Parameter	Conditions	Min	Max	Unit
$V_{INPUT}$	Input Voltage of Bridge	INPUT1 to INPUT2 or INPUT2 to INPUT1	-	57	V
$V_G$	Gate Voltage of MOSFETs	G1, G4 to OUTN G2, G3 to OUTP	-	57	V
$I_{INPUT}$	Input Current of Bridge	Bridge Current through Q2 and Q4 or (Q3 and Q1)	-	1.7	A
Ambient Operation Temperature ( $T_A$ )			-40	85	°C
Junction Operating Temperature ( $T_J$ ) (Note 4)			-40	125	°C

Functional operation above the stresses listed in the Recommended Operating Ranges is not implied. Extended exposure to stresses beyond the Recommended Operating Ranges limits may affect device reliability.

4. Backfeed Voltage can not be guaranteed for junction temperature in excess of 85°C. See  $V_{BF}$  in Electrical Characteristics Table.

## ELECTRICAL CHARACTERISTICS ( $T_J = 25^\circ\text{C}$ unless otherwise noted)

Symbol	Parameter	Conditions	Min	Typ	Max	Unit
$V_{INPUT}$	Input Voltage of Bridge	At INPUT1 to INPUT2 or INPUT2 to INPUT1	-	-	57	V
$V_G$	Gate Voltage of MOSFETs	At G1, G4 to OUTN and G2, G3 to OUTP	-	-	57	V
$I_Q$	Quiescent Current	Detection Mode $1.5\text{ V} < V_{INPUT} = V_G < 10.1\text{ V}$ (Note 5)	-	-	5	$\mu\text{A}$
		Classification Mode $10.2\text{ V} < V_{INPUT} = V_G < 23.9\text{ V}$ (Note 5)	-	-	400	$\mu\text{A}$
		Power On Mode Maximum $V_{INPUT} = V_G = 57\text{ V}$ (Note 5)	-	-	3.2	mA
$V_{TURN\_ON}$	Turn-On Voltage of MOSFETs	Turn-On of MOSFETs while $V_G$ Increases (Note 4)	32	-	36	V
$I_{LEAKAGE}$	Turn-Off Leakage Current	$V_{OUTP} = 57\text{ V}$ , $V_{OUTN} = 0\text{ V}$ $T_J = -40^\circ\text{C}$ to $85^\circ\text{C}$ (Note 5)	-	-	700	$\mu\text{A}$
$V_{BF}$	Backfeed Voltage	$V_{OUTP} = 57\text{ V}$ , $V_{OUTN} = 0\text{ V}$ , 100 k $\Omega$ between INPUT1 and INPUT2 $T_J = -40^\circ\text{C}$ to $85^\circ\text{C}$ (Note 5)	-	-	2.7	V
$R_{DS(on)}$	N-ch MOSFET	$V_G = 42\text{ V}$ , $I_{INPUT} = 1.5\text{ A}$ , $T_A = 25^\circ\text{C}$	-	35	51	m $\Omega$
		$V_G = 48\text{ V}$ , $I_{INPUT} = 1.5\text{ A}$ , $T_A = 25^\circ\text{C}$	-	29	44	m $\Omega$
		$V_G = 57\text{ V}$ , $I_{INPUT} = 1.5\text{ A}$ , $T_A = 25^\circ\text{C}$	-	26	37	m $\Omega$
	P-ch MOSFET	$V_G = -42\text{ V}$ , $I_{INPUT} = -1.5\text{ A}$ , $T_A = 25^\circ\text{C}$	-	95	147	m $\Omega$
		$V_G = -48\text{ V}$ , $I_{INPUT} = -1.5\text{ A}$ , $T_A = 25^\circ\text{C}$	-	83	125	m $\Omega$
		$V_G = -57\text{ V}$ , $I_{INPUT} = -1.5\text{ A}$ , $T_A = 25^\circ\text{C}$	-	76	107	m $\Omega$

Product parametric performance is indicated in the Electrical Characteristics for the listed test conditions, unless otherwise noted. Product performance may not be indicated by the Electrical Characteristics if operated under different conditions.

5. INPUT1 is connected to G3 and G4 and also INPUT2 is connected to G1 and G2 like below.

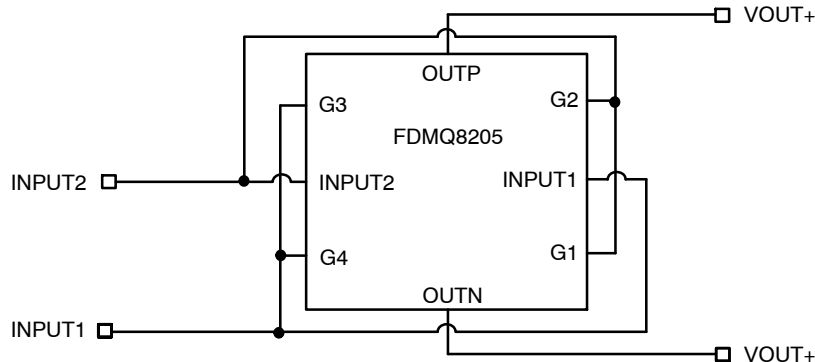

TYPICAL CHARACTERISTICS (Q1 OR Q4 N-CHANNEL)

( $T_J = 25^\circ\text{C}$  unless otherwise noted.)

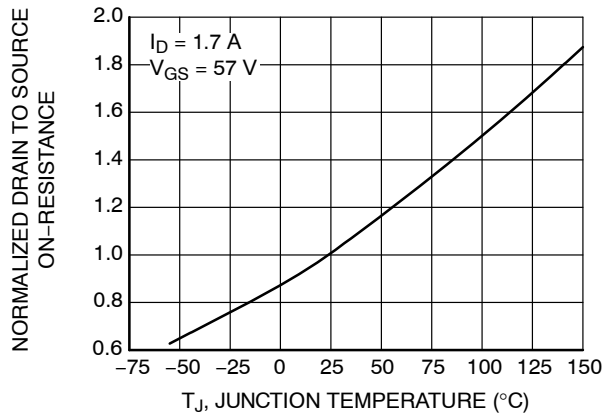

Figure 4. Normalized On Resistance vs. Junction Temperature

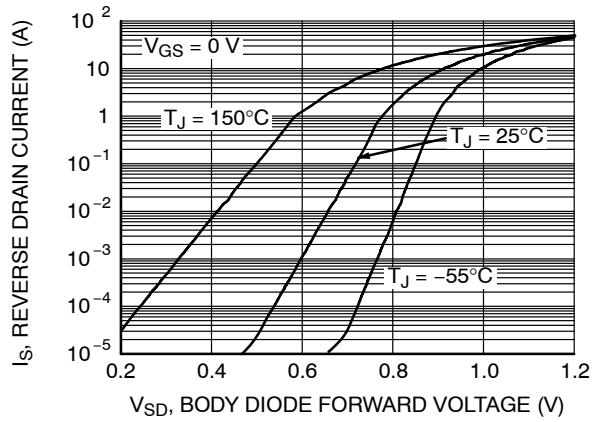

Figure 5. Source to Drain Diode Forward Voltage vs. Source Current

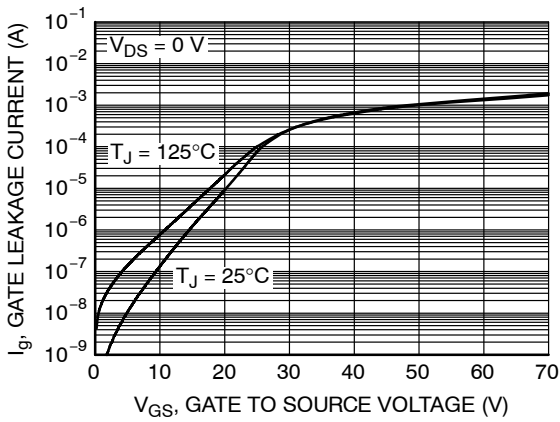

Figure 6. Gate Leakage Current vs. Gate to Source Voltage

TYPICAL CHARACTERISTICS (Q2 OR Q3 P-CHANNEL)

( $T_J = 25^\circ\text{C}$  unless otherwise noted.)

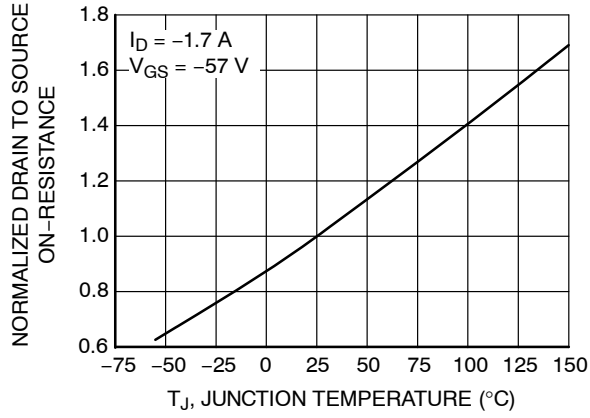

Figure 7. Normalized On Resistance vs. Junction Temperature

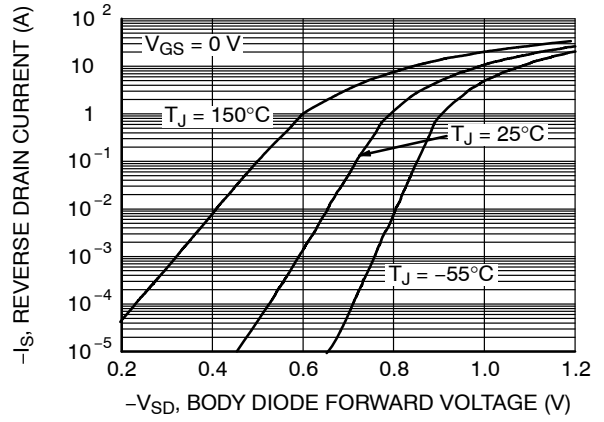

Figure 8. Source to Drain Diode Forward Voltage vs. Source Current

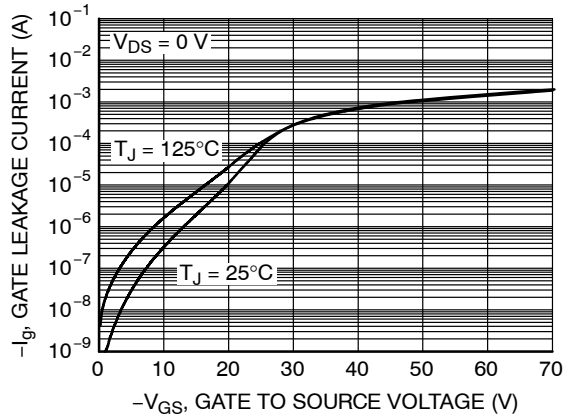

Figure 9. Gate Leakage Current vs. Gate to Source Voltage

TYPICAL CHARACTERISTICS (Q1 + Q3 OR Q2 + Q4 IN SERIAL)

( $T_J = 25^\circ\text{C}$  unless otherwise noted.)

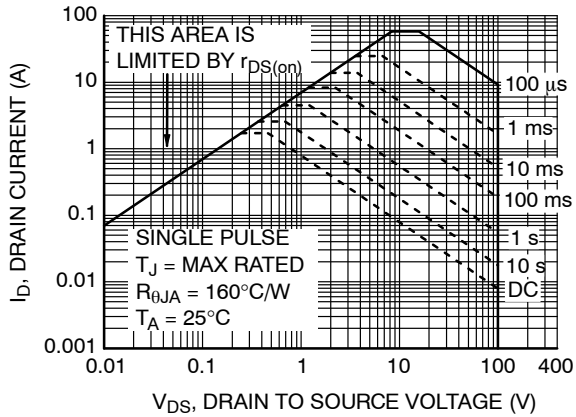

Figure 10. Forward Bias Safe Operating Area

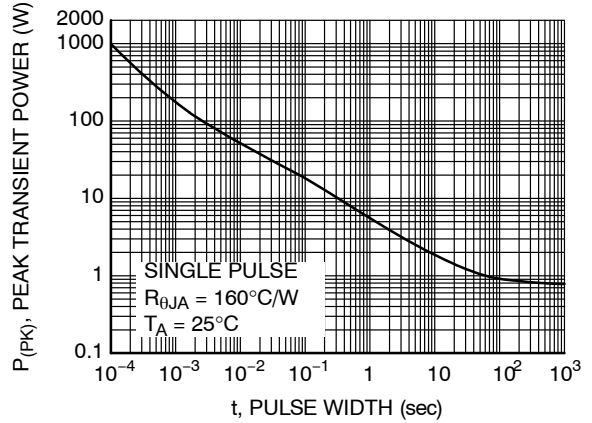

Figure 11. Single Pulse Maximum Power Dissipation

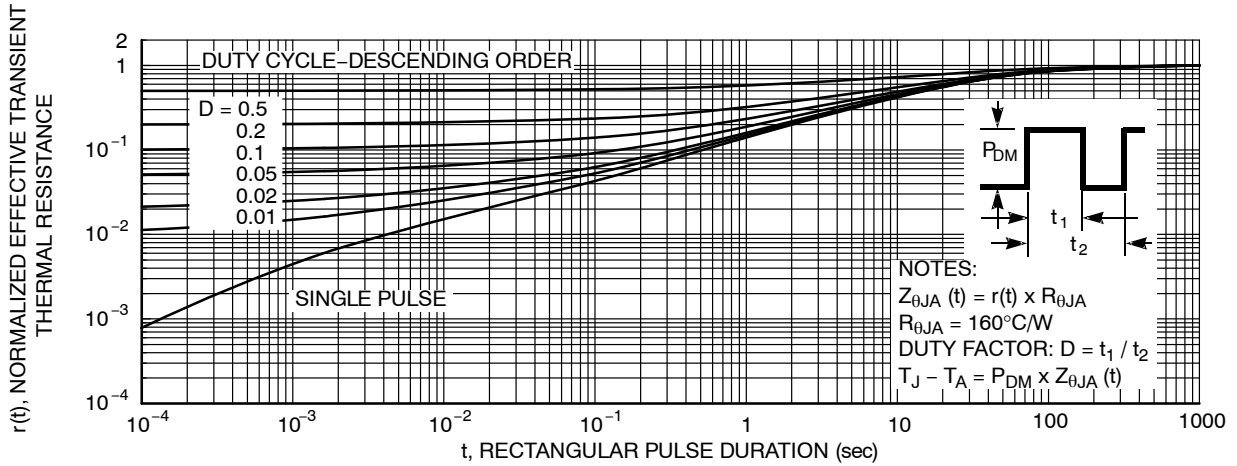

Figure 12. Junction-to-Ambient Transient Thermal Response Curve

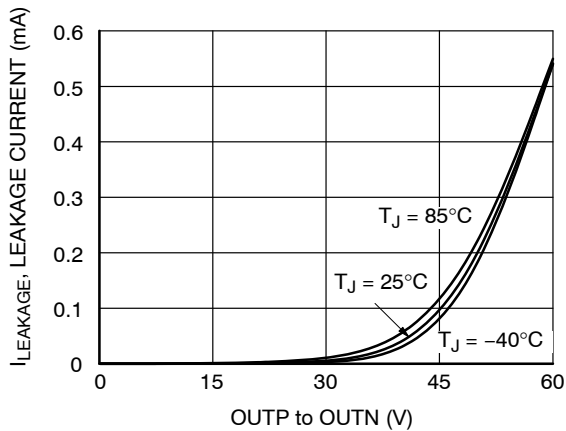

Figure 13. Leakage vs. Output Voltage Curve



# FDMQ8205

## ORDERING INFORMATION

Device Marking	Device	Package	Reel Size	Tape Width	Shipping†
FDMQ8205	FDMQ8205	MLP4.5x5	13"	12 mm	3000 / Tape & Reel

†For information on tape and reel specifications, including part orientation and tape sizes, please refer to our Tape and Reel Packaging Specifications Brochure, [BRD8011/D](#).

# MECHANICAL CASE OUTLINE

## PACKAGE DIMENSIONS

ON Semiconductor®



**WDFN12 5x4.5, 0.8P**  
CASE 511CS  
ISSUE O

DATE 31 AUG 2016

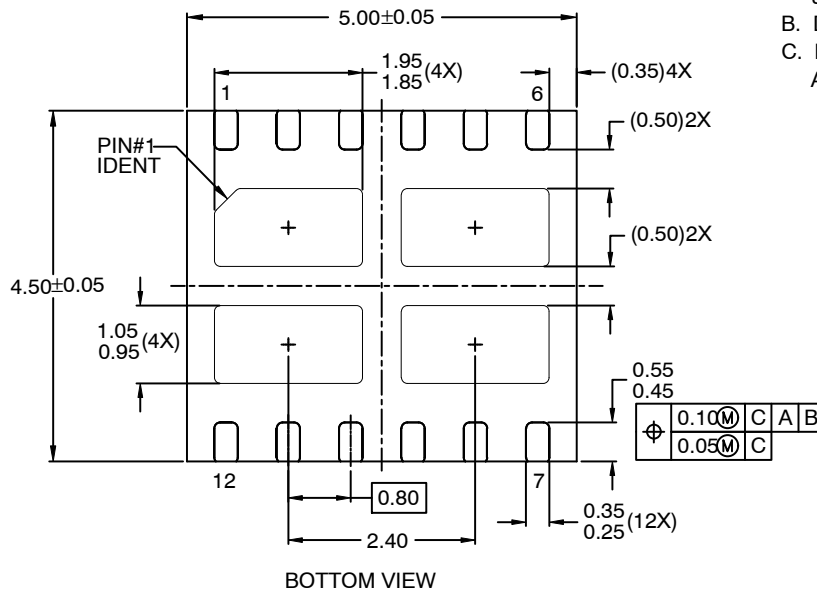
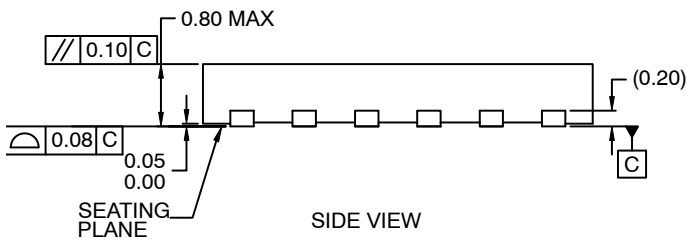
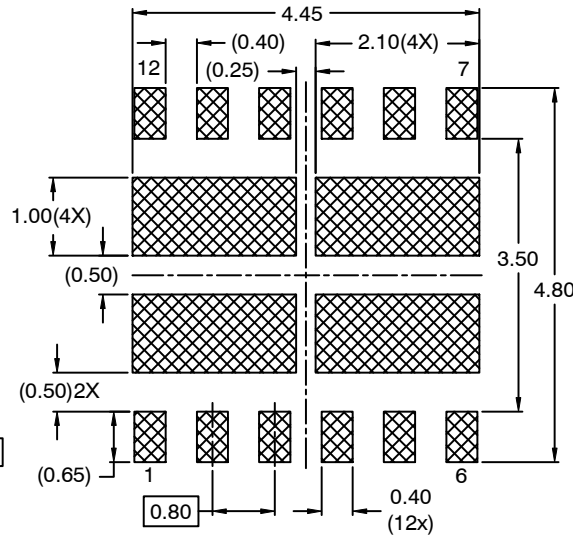
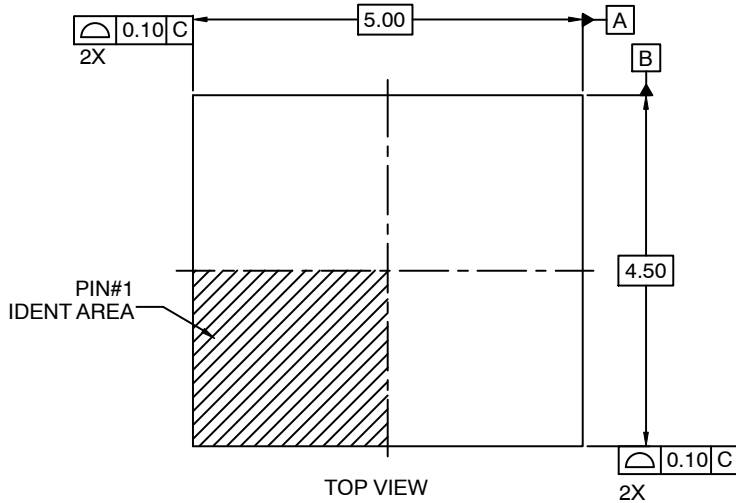

**NOTES:**

- A. PACKAGE DOES NOT FULLY CONFORM TO JEDEC MO-229 REGISTRATION
- B. DIMENSIONS ARE IN MILLIMETERS.
- C. DIMENSIONS AND TOLERANCES PER ASME Y14.5M, 1994.

<b>DOCUMENT NUMBER:</b>	<b>98AON13607G</b>	Electronic versions are uncontrolled except when accessed directly from the Document Repository. Printed versions are uncontrolled except when stamped "CONTROLLED COPY" in red.
<b>DESCRIPTION:</b>	<b>WDFN12 5X4.5, 0.8P</b>	<b>PAGE 1 OF 1</b>

ON Semiconductor and are trademarks of Semiconductor Components Industries, LLC dba ON Semiconductor or its subsidiaries in the United States and/or other countries. ON Semiconductor reserves the right to make changes without further notice to any products herein. ON Semiconductor makes no warranty, representation or guarantee regarding the suitability of its products for any particular purpose, nor does ON Semiconductor assume any liability arising out of the application or use of any product or circuit, and specifically disclaims any and all liability, including without limitation special, consequential or incidental damages. ON Semiconductor does not convey any license under its patent rights nor the rights of others.

**onsemi**, **Onsemi**, and other names, marks, and brands are registered and/or common law trademarks of Semiconductor Components Industries, LLC dba "**onsemi**" or its affiliates and/or subsidiaries in the United States and/or other countries. **onsemi** owns the rights to a number of patents, trademarks, copyrights, trade secrets, and other intellectual property. A listing of **onsemi**'s product/patent coverage may be accessed at [www.onsemi.com/site/pdf/Patent-Marking.pdf](http://www.onsemi.com/site/pdf/Patent-Marking.pdf). **onsemi** reserves the right to make changes at any time to any products or information herein, without notice. The information herein is provided "as-is" and **onsemi** makes no warranty, representation or guarantee regarding the accuracy of the information, product features, availability, functionality, or suitability of its products for any particular purpose, nor does **onsemi** assume any liability arising out of the application or use of any product or circuit, and specifically disclaims any and all liability, including without limitation special, consequential or incidental damages. Buyer is responsible for its products and applications using **onsemi** products, including compliance with all laws, regulations and safety requirements or standards, regardless of any support or applications information provided by **onsemi**. "Typical" parameters which may be provided in **onsemi** data sheets and/or specifications can and do vary in different applications and actual performance may vary over time. All operating parameters, including "Typicals" must be validated for each customer application by customer's technical experts. **onsemi** does not convey any license under any of its intellectual property rights nor the rights of others. **onsemi** products are not designed, intended, or authorized for use as a critical component in life support systems or any FDA Class 3 medical devices or medical devices with a same or similar classification in a foreign jurisdiction or any devices intended for implantation in the human body. Should Buyer purchase or use **onsemi** products for any such unintended or unauthorized application, Buyer shall indemnify and hold **onsemi** and its officers, employees, subsidiaries, affiliates, and distributors harmless against all claims, costs, damages, and expenses, and reasonable attorney fees arising out of, directly or indirectly, any claim of personal injury or death associated with such unintended or unauthorized use, even if such claim alleges that **onsemi** was negligent regarding the design or manufacture of the part. **onsemi** is an Equal Opportunity/Affirmative Action Employer. This literature is subject to all applicable copyright laws and is not for resale in any manner.

## ADDITIONAL INFORMATION

### TECHNICAL PUBLICATIONS:

Technical Library: [www.onsemi.com/design/resources/technical-documentation](http://www.onsemi.com/design/resources/technical-documentation)  
onsemi Website: [www.onsemi.com](http://www.onsemi.com)

### ONLINE SUPPORT: [www.onsemi.com/support](http://www.onsemi.com/support)

For additional information, please contact your local Sales Representative at [www.onsemi.com/support/sales](http://www.onsemi.com/support/sales)