

# MOSFET – Dual P-Channel POWERTRENCH®

**-20 V, -2.6 A, 142 mΩ**

## FDME1023PZT

### Description

This device is designed specifically as a single package solution for the battery charges switch in cellular handset and other ultra-portable applications. It features two independent P-Channel MOSFETs with low on-state resistance for minimum conduction losses. When connected in the typical common source configuration, bi-directional current flow is possible.

The MicroFET 1.6x1.6 **Thin** package offers exceptional thermal performance for its physical size and is well suited to switching and linear mode applications.

### Features

- Max  $R_{DS(on)}$  = 142 mΩ at  $V_{GS} = -4.5$  V,  $I_D = -2.3$  A
- Max  $R_{DS(on)}$  = 213 mΩ at  $V_{GS} = -2.5$  V,  $I_D = -1.8$  A
- Max  $R_{DS(on)}$  = 331 mΩ at  $V_{GS} = -1.8$  V,  $I_D = -1.5$  A
- Max  $R_{DS(on)}$  = 530 mΩ at  $V_{GS} = -1.5$  V,  $I_D = -1.2$  A
- Low Profile: 0.55 mm Maximum in the New Package MicroFET 1.6x1.6 **Thin**
- HBM ESD Protection Level > 1600 V (Note 3)
- This Device is Pb-Free, Halide Free and RoHS Compliant

### Typical Applications

- Load Switch
- Battery Charging
- Battery Disconnect Switch

### ABSOLUTE MAXIMUM RATINGS ( $T_A = 25^\circ\text{C}$ unless otherwise noted)

| Symbol         | Parameter  | Value  | Unit |
|----------------|--|--|------|
| $V_{DS}$       | Drain to Source Voltage  | -20  | V    |
| $V_{GS}$       | Gate to Source Voltage   | ±8   | V    |
| $I_D$          | Drain Current<br>– Continuous (Note 1a)<br>– Pulsed                  | $T_A = 25^\circ\text{C}$<br>-2.6<br>-6                             | A    |
| $P_D$          | Power Dissipation for Single Operation<br>– (Note 1a)<br>– (Note 1b) | $T_A = 25^\circ\text{C}$<br>1.4<br>$T_A = 25^\circ\text{C}$<br>0.6 | W    |
| $T_J, T_{STG}$ | Operating and Storage Junction Temperature Range                     | -55 to +150  | °C   |

Stresses exceeding those listed in the Maximum Ratings table may damage the device. If any of these limits are exceeded, device functionality should not be assumed, damage may occur and reliability may be affected.

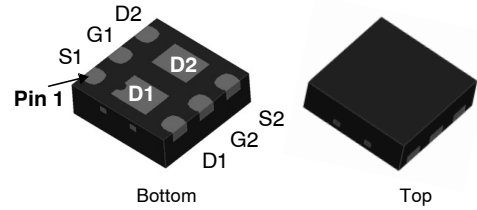

UDFN6 1.6 x 1.6 0.5P  
(MicroFET™ 1.6 x 1.6 Thin)  
CASE 517DW

### ELECTRICAL CONNECTION

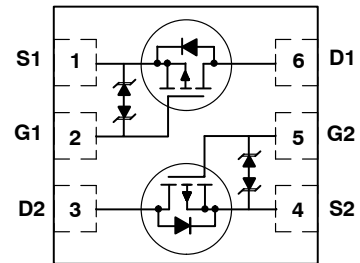

Dual P-Channel MOSFET  
(Top View)

### MARKING DIAGRAM

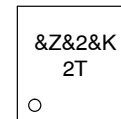

- &Z = Assembly Plant Code
- &2 = 2-Digit Date Code (Year and Week)
- &K = 2-Digit Lot Run Code
- 2T = Specific Device Code

### ORDERING INFORMATION

See detailed ordering and shipping information on page 6 of this data sheet.

# FDME1023PZT

## THERMAL CHARACTERISTICS

| Symbol          | Parameter  | Value | Unit |
|-----------------|--|-------|------|
| $R_{\theta JA}$ | Thermal Resistance, Junction to Ambient (Single Operation) (Note 1a) | 90    | °C/W |
| $R_{\theta JA}$ | Thermal Resistance, Junction to Ambient (Single Operation) (Note 1b) | 195   |      |

## ELECTRICAL CHARACTERISTICS $T_A = 25^\circ\text{C}$ unless otherwise noted

| Symbol | Parameter | Test Conditions | Min | Typ | Max | Units |
|--------|-----------|-----------------|-----|-----|-----|-------|
|--------|-----------|-----------------|-----|-----|-----|-------|

### Off Characteristics

|                                      |   |   |     |     |          |               |
|--------------------------------------|---|---|-----|-----|----------|---------------|
| $BV_{DSS}$                           | Drain to Source Breakdown Voltage         | $I_D = -250 \mu\text{A}, V_{GS} = 0 \text{ V}$              | -20 | -   | -        | V             |
| $\frac{\Delta BV_{DSS}}{\Delta T_J}$ | Breakdown Voltage Temperature Coefficient | $I_D = -250 \mu\text{A}$ , referenced to $25^\circ\text{C}$ | -   | -12 | -        | mV/°C         |
| $I_{DSS}$                            | Zero Gate Voltage Drain Current           | $V_{DS} = -16 \text{ V}, V_{GS} = 0 \text{ V}$              | -   | -   | -1       | $\mu\text{A}$ |
| $I_{GSS}$                            | Gate to Source Leakage Current            | $V_{GS} = \pm 8 \text{ V}, V_{DS} = 0 \text{ V}$            | -   | -   | $\pm 10$ | $\mu\text{A}$ |

### On Characteristics

|  |  |  |      |      |      |            |
|--|--|--|------|------|------|------------|
| $V_{GS(th)}$                           | Gate to Source Threshold Voltage                         | $V_{GS} = V_{DS}, I_D = -250 \mu\text{A}$                                | -0.4 | -0.6 | -1.0 | V          |
| $\frac{\Delta V_{GS(th)}}{\Delta T_J}$ | Gate to Source Threshold Voltage Temperature Coefficient | $I_D = -250 \mu\text{A}$ , referenced to $25^\circ\text{C}$              | -    | 2    | -    | mV/°C      |
| $R_{DS(on)}$                           | Drain to Source On Resistance                            | $V_{GS} = -4.5 \text{ V}, I_D = -2.3 \text{ A}$                          | -    | 95   | 142  | m $\Omega$ |
|  |  | $V_{GS} = -2.5 \text{ V}, I_D = -1.8 \text{ A}$                          | -    | 120  | 213  |            |
|  |  | $V_{GS} = -1.8 \text{ V}, I_D = -1.5 \text{ A}$                          | -    | 150  | 331  |            |
|  |  | $V_{GS} = -1.5 \text{ V}, I_D = -1.2 \text{ A}$                          | -    | 190  | 530  | m $\Omega$ |
|  |  | $V_{GS} = -4.5 \text{ V}, I_D = -2.3 \text{ A}, T_J = 125^\circ\text{C}$ | -    | 128  | 190  | m $\Omega$ |
| $g_{FS}$                               | Forward Transconductance                                 | $V_{DS} = -4.5 \text{ V}, I_D = -2.3 \text{ A}$                          | -    | 7    | -    | S          |

### Dynamic Characteristics

|           |                              |   |   |     |     |    |
|-----------|------------------------------|---|---|-----|-----|----|
| $C_{iss}$ | Input Capacitance            | $V_{DS} = -10 \text{ V}, V_{GS} = 0 \text{ V}, f = 1 \text{ MHz}$ | - | 305 | 405 | pF |
| $C_{oss}$ | Output Capacitance           |   | - | 55  | 75  | pF |
| $C_{rss}$ | Reverse Transfer Capacitance |   | - | 50  | 75  | pF |

### Switching Characteristics

|              |                               |   |   |     |     |    |
|--------------|-------------------------------|---|---|-----|-----|----|
| $t_{d(on)}$  | Turn-On Delay Time            | $V_{DD} = -10 \text{ V}, I_D = -1 \text{ A}, V_{GS} = -4.5 \text{ V}, R_{GEN} = 6 \Omega$ | - | 4.7 | 10  | ns |
| $t_r$        | Rise Time                     |   | - | 4.8 | 10  | ns |
| $t_{d(off)}$ | Turn-Off Delay Time           |   | - | 33  | 53  | ns |
| $t_f$        | Fall Time                     |   | - | 16  | 29  | ns |
| $Q_g$        | Total Gate Charge             | $V_{DD} = -10 \text{ V}, I_D = -2.3 \text{ A}, V_{GS} = -4.5 \text{ V}$                   | - | 5.5 | 7.7 | nC |
| $Q_{gs}$     | Gate to Source Gate Charge    |   | - | 0.6 | -   | nC |
| $Q_{gd}$     | Gate to Drain "Miller" Charge |   | - | 1.4 | -   | nC |

### Drain-Source Diode Characteristics

|          |                                       |   |   |      |      |    |
|----------|---------------------------------------|---|---|------|------|----|
| $V_{SD}$ | Source to Drain Diode Forward Voltage | $V_{GS} = 0 \text{ V}, I_S = -0.9 \text{ A}$ (Note 2)     | - | -0.8 | -1.2 | V  |
| $t_{rr}$ | Reverse Recovery Time                 | $I_F = -2.3 \text{ A}, di/dt = 100 \text{ A}/\mu\text{s}$ | - | 16   | 29   | ns |
| $Q_{rr}$ | Reverse Recovery Charge               |   | - | 4.4  | 10   | nC |

Product parametric performance is indicated in the Electrical Characteristics for the listed test conditions, unless otherwise noted. Product performance may not be indicated by the Electrical Characteristics if operated under different conditions.

# FDME1023PZT

## NOTES:

1.  $R_{\theta JA}$  is determined with the device mounted on a 1 in<sup>2</sup> pad 2 oz copper pad on a 1.5 x 1.5 in. board of FR-4 material.  $R_{\theta JC}$  is guaranteed by design while  $R_{\theta JA}$  is determined by the user's board design.

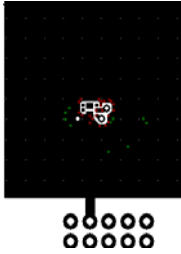

a. 90°C/W when mounted on  
a 1 in<sup>2</sup> pad of 2 oz copper

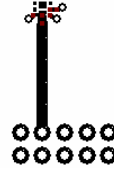

b. 195°C/W when mounted on  
a minimum pad of 2 oz copper

2. Pulse Test : Pulse Width < 300  $\mu$ s, Duty Cycle < 2.0%
3. The diode connected between gate and source serves only as protection against ESD. No gate overvoltage rating is implied.

# FDME1023PZT

## TYPICAL CHARACTERISTICS ( $T_J = 25^\circ\text{C}$ unless otherwise noted)

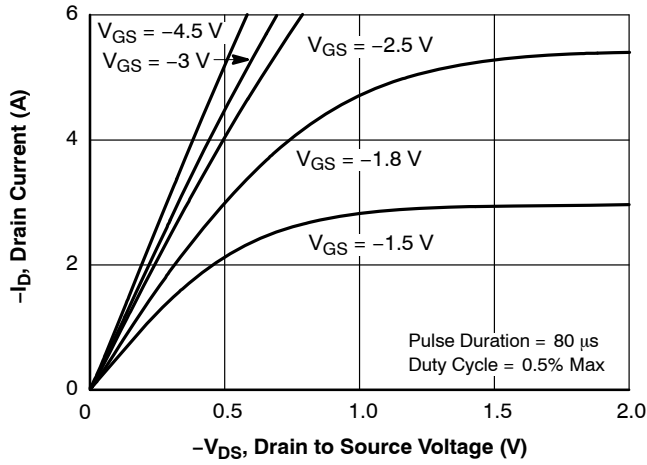

Figure 1. On Region Characteristics

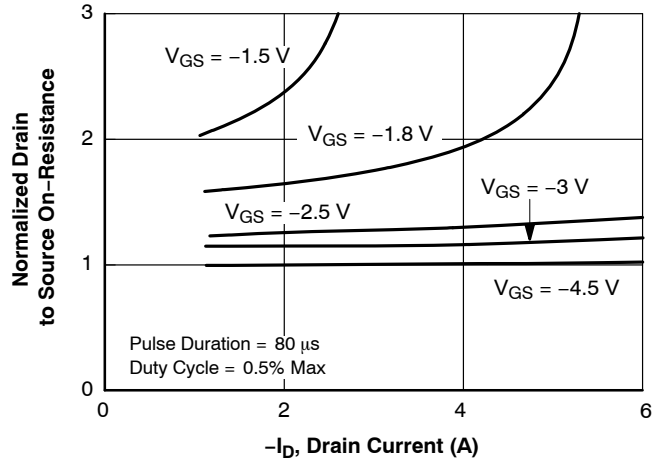

Figure 2. Normalized On-Resistance vs. Drain Current and Gate Voltage

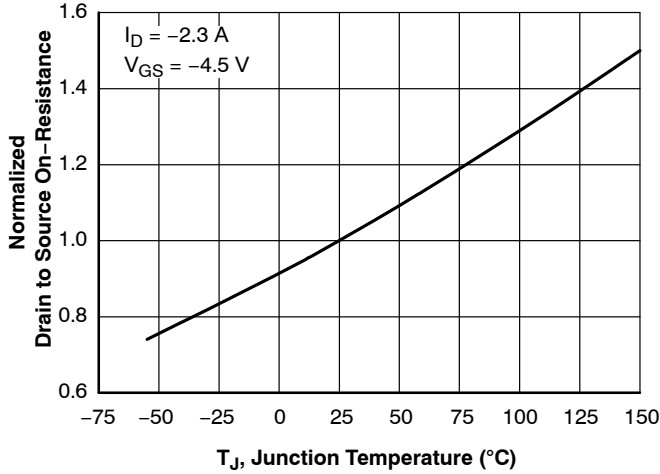

Figure 3. Normalized On Resistance vs. Junction Temperature

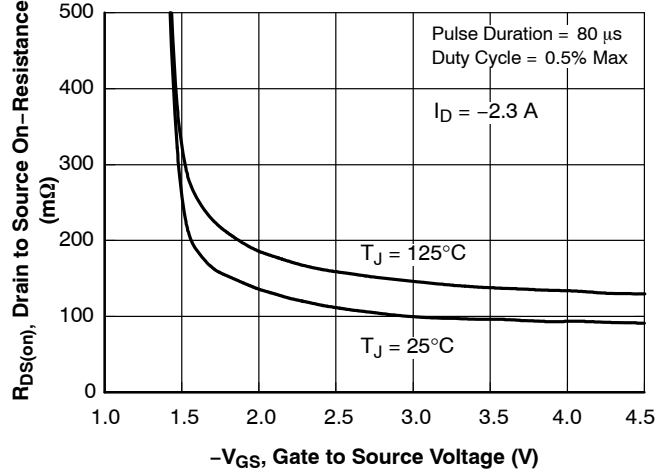

Figure 4. On-Resistance vs. Gate to Source Voltage

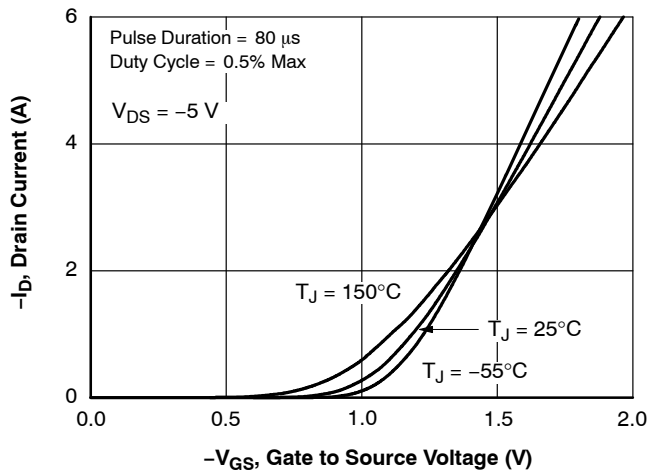

Figure 5. Transfer Characteristics

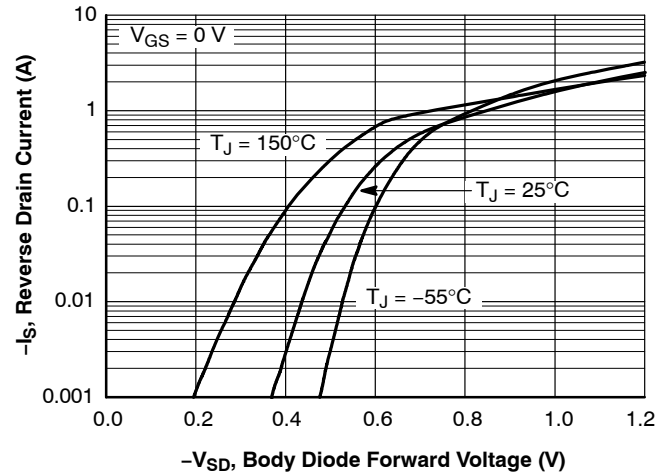

Figure 6. Source to Drain Diode Forward Voltage vs. Source Current

TYPICAL CHARACTERISTICS ( $T_J = 25^\circ\text{C}$  unless otherwise noted) (continued)

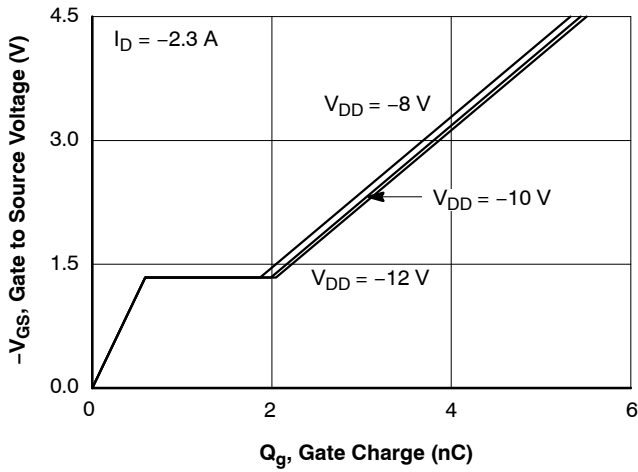

Figure 8. Gate Charge Characteristics

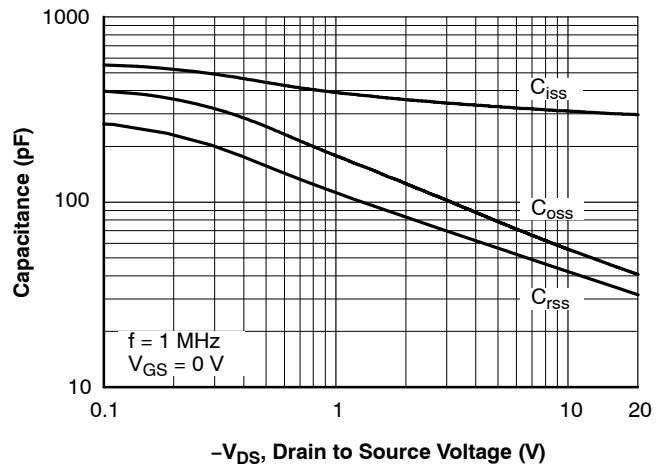

Figure 9. Capacitance vs. Drain to Source Voltage

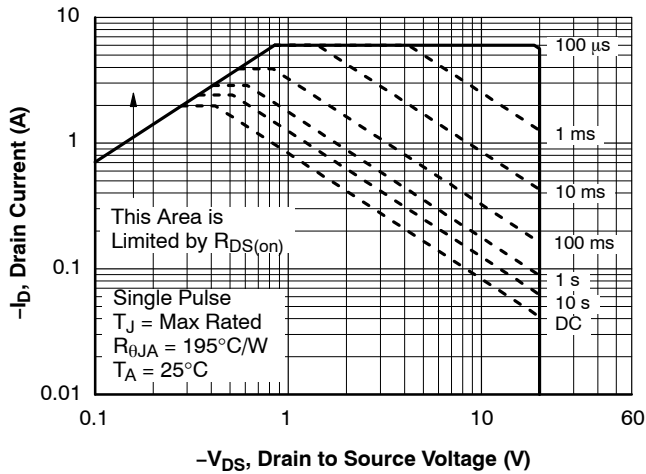

Figure 7. Forward Bias Safe Operating Area

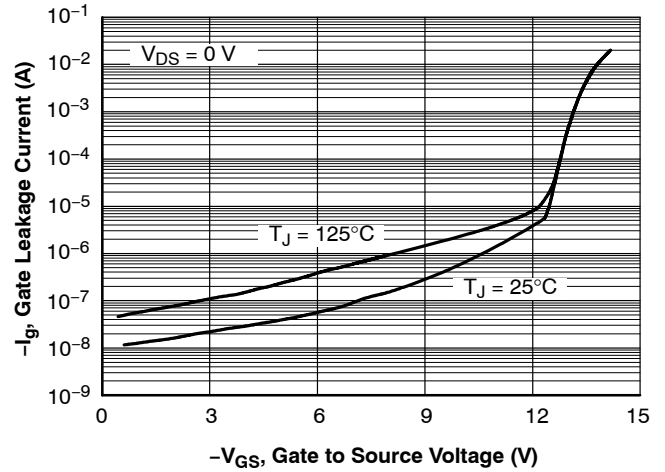

Figure 10. Gate Leakage Current vs. Gate to Source Voltage

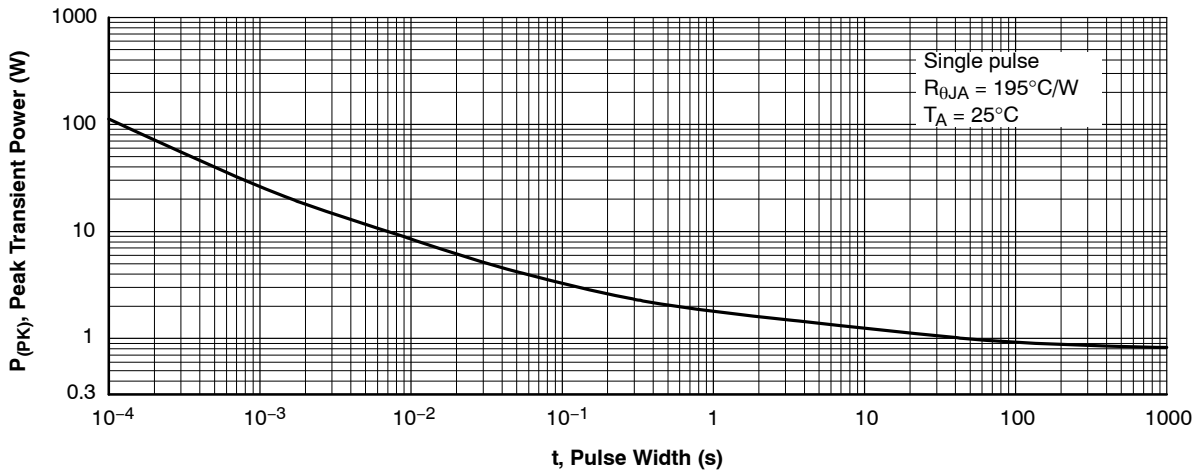

Figure 11. Single Pulse Maximum Power Dissipation

# FDME1023PZT

## TYPICAL CHARACTERISTICS ( $T_J = 25^\circ\text{C}$ unless otherwise noted) (continued)

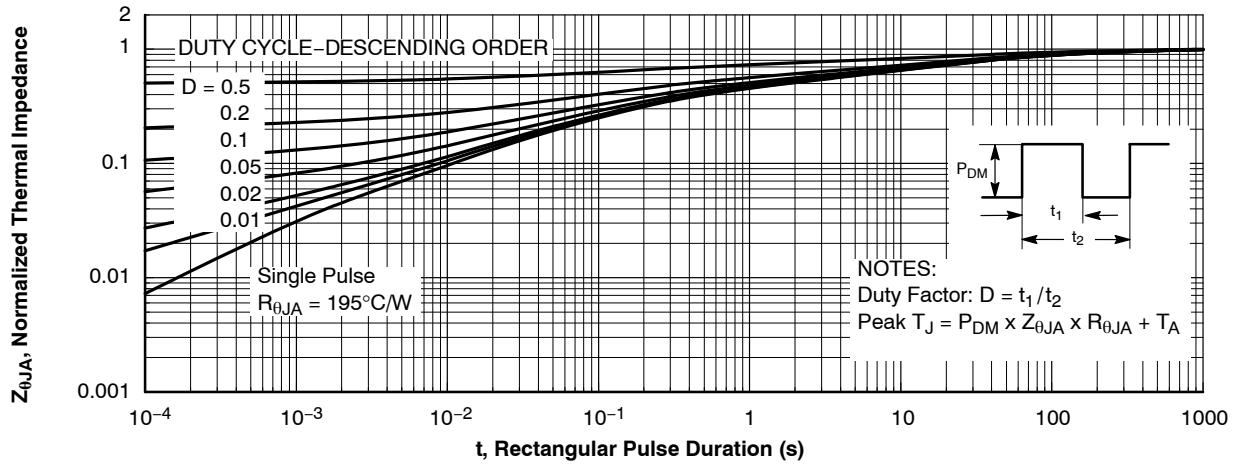

Figure 12. Junction-to-Ambient Transient Thermal Response Curve

### PACKAGE MARKING AND ORDERING INFORMATION

| Device      | Device Marking | Package Type   | Reel Size | Tape Width | Shipping <sup>†</sup> |
|-------------|----------------|--|-----------|------------|-----------------------|
| FDME1023PZT | 2T             | UDFN6 1.6×1.6 0.5P<br>(MicroFET 1.6×1.6 Thin)<br>(Pb-Free/Halide Free) | 7"        | 8 mm       | 5000 / Tape & Reel    |

<sup>†</sup>For information on tape and reel specifications, including part orientation and tape sizes, please refer to our Tape and Reel Packaging Specifications Brochure, [BRD8011/D](#).

POWERTRENCH is a registered trademark of Semiconductor Components Industries, LLC dba "onsemi" or its affiliates and/or subsidiaries in the United States and/or other countries.

MicroFET is a trademark of Semiconductor Components Industries, LLC dba "onsemi" or its affiliates and/or subsidiaries in the United States and/or other countries.



**UDFN6 1.6x1.6, 0.5P**  
CASE 517DW  
ISSUE O

DATE 31 OCT 2016

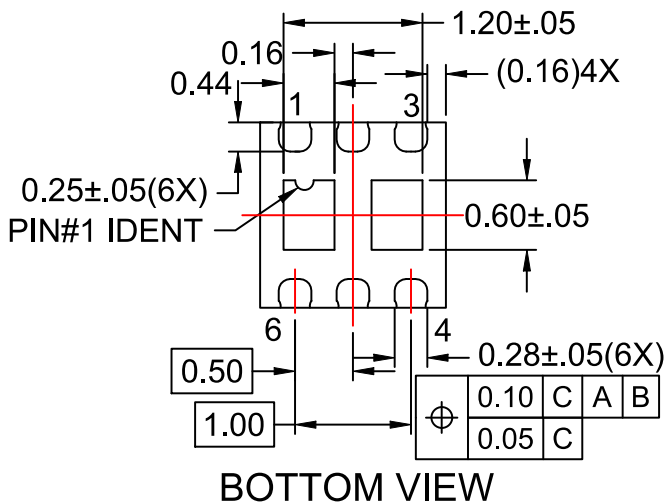
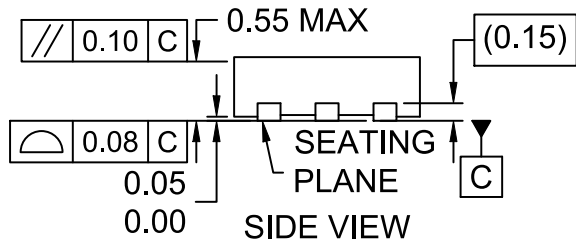
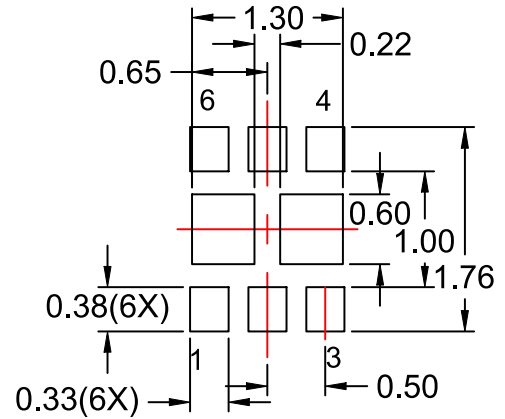
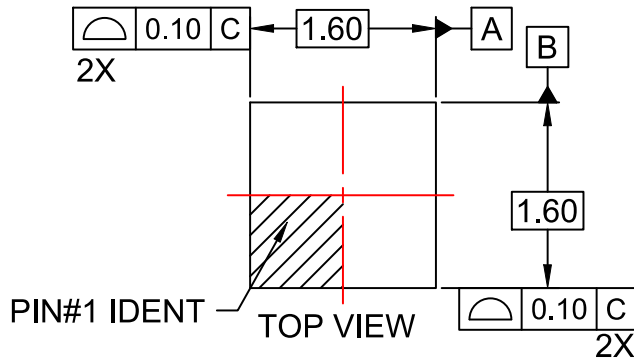

**NOTES:**

- A. PACKAGE DOES NOT CONFORM TO ANY JEDEC STANDARD.
- B. DIMENSIONS ARE IN MILLIMETERS.
- C. DIMENSIONS AND TOLERANCES PER ASME Y14.5M, 2009.
- D. LAND PATTERN RECOMMENDATION IS EXISTING INDUSTRY LAND PATTERN.

|                         |                            |  |
|-------------------------|----------------------------|--|
| <b>DOCUMENT NUMBER:</b> | <b>98AON13701G</b>         | Electronic versions are uncontrolled except when accessed directly from the Document Repository. Printed versions are uncontrolled except when stamped "CONTROLLED COPY" in red. |
| <b>DESCRIPTION:</b>     | <b>UDFN6 1.6x1.6, 0.5P</b> | <b>PAGE 1 OF 1</b>   |

ON Semiconductor and are trademarks of Semiconductor Components Industries, LLC dba ON Semiconductor or its subsidiaries in the United States and/or other countries. ON Semiconductor reserves the right to make changes without further notice to any products herein. ON Semiconductor makes no warranty, representation or guarantee regarding the suitability of its products for any particular purpose, nor does ON Semiconductor assume any liability arising out of the application or use of any product or circuit, and specifically disclaims any and all liability, including without limitation special, consequential or incidental damages. ON Semiconductor does not convey any license under its patent rights nor the rights of others.

**onsemi**, **Onsemi**, and other names, marks, and brands are registered and/or common law trademarks of Semiconductor Components Industries, LLC dba "**onsemi**" or its affiliates and/or subsidiaries in the United States and/or other countries. **onsemi** owns the rights to a number of patents, trademarks, copyrights, trade secrets, and other intellectual property. A listing of **onsemi**'s product/patent coverage may be accessed at [www.onsemi.com/site/pdf/Patent-Marking.pdf](http://www.onsemi.com/site/pdf/Patent-Marking.pdf). **onsemi** reserves the right to make changes at any time to any products or information herein, without notice. The information herein is provided "as-is" and **onsemi** makes no warranty, representation or guarantee regarding the accuracy of the information, product features, availability, functionality, or suitability of its products for any particular purpose, nor does **onsemi** assume any liability arising out of the application or use of any product or circuit, and specifically disclaims any and all liability, including without limitation special, consequential or incidental damages. Buyer is responsible for its products and applications using **onsemi** products, including compliance with all laws, regulations and safety requirements or standards, regardless of any support or applications information provided by **onsemi**. "Typical" parameters which may be provided in **onsemi** data sheets and/or specifications can and do vary in different applications and actual performance may vary over time. All operating parameters, including "Typicals" must be validated for each customer application by customer's technical experts. **onsemi** does not convey any license under any of its intellectual property rights nor the rights of others. **onsemi** products are not designed, intended, or authorized for use as a critical component in life support systems or any FDA Class 3 medical devices or medical devices with a same or similar classification in a foreign jurisdiction or any devices intended for implantation in the human body. Should Buyer purchase or use **onsemi** products for any such unintended or unauthorized application, Buyer shall indemnify and hold **onsemi** and its officers, employees, subsidiaries, affiliates, and distributors harmless against all claims, costs, damages, and expenses, and reasonable attorney fees arising out of, directly or indirectly, any claim of personal injury or death associated with such unintended or unauthorized use, even if such claim alleges that **onsemi** was negligent regarding the design or manufacture of the part. **onsemi** is an Equal Opportunity/Affirmative Action Employer. This literature is subject to all applicable copyright laws and is not for resale in any manner.

## ADDITIONAL INFORMATION

### TECHNICAL PUBLICATIONS:

Technical Library: [www.onsemi.com/design/resources/technical-documentation](http://www.onsemi.com/design/resources/technical-documentation)  
onsemi Website: [www.onsemi.com](http://www.onsemi.com)

### ONLINE SUPPORT: [www.onsemi.com/support](http://www.onsemi.com/support)

For additional information, please contact your local Sales Representative at [www.onsemi.com/support/sales](http://www.onsemi.com/support/sales)