

# MOSFET – Dual N-Channel, POWERTRENCH®

60 V, 8.2 A, 17 mΩ

## FDMC89521L

### General Description

This device includes two 60 V N-Channel MOSFETs in a dual Power 33 (3 mm x 3 mm MLP) package. The package is enhanced for exceptional thermal performance.

### Features

- Max  $r_{DS(on)}$  = 17 mΩ at  $V_{GS} = 10$  V,  $I_D = 8.2$  A
- Max  $r_{DS(on)}$  = 27 mΩ at  $V_{GS} = 4.5$  V,  $I_D = 6.7$  A
- Termination is Lead-free
- These Devices are RoHS Compliant

### Applications

- Battery Protection
- Load Switching
- Bridge Topologies

### MOSFET MAXIMUM RATINGS (T<sub>A</sub> = 25°C unless otherwise noted)

Symbol	Parameter	Ratings	Units
V <sub>DS</sub>	Drain to Source Voltage	60	V
V <sub>GS</sub>	Gate to Source Voltage	±20	V
I <sub>D</sub>	Drain Current – Continuous T <sub>A</sub> = 25°C (Note 1a) – Pulsed	8.2 40	A
E <sub>AS</sub>	Single Pulse Avalanche Energy (Note 3)	32	mJ
P <sub>D</sub>	Power Dissipation T <sub>C</sub> = 25°C	16	W
	Power Dissipation T <sub>A</sub> = 25°C (Note 1a)	1.9	
T <sub>J</sub> , T <sub>STG</sub>	Operating and Storage Junction Temperature Range	–55 to +150	°C

Stresses exceeding those listed in the Maximum Ratings table may damage the device. If any of these limits are exceeded, device functionality should not be assumed, damage may occur and reliability may be affected.

### THERMAL CHARACTERISTICS

Symbol	Parameter	Ratings	Unit
R <sub>θJC</sub>	Thermal Resistance, Junction-to-Case	8.0	°C/W
R <sub>θJA</sub>	Thermal Resistance, Junction-to-Ambient (Note 1a)	65	°C/W
R <sub>θJA</sub>	Thermal Resistance, Junction-to-Ambient (Note 1b)	155	°C/W

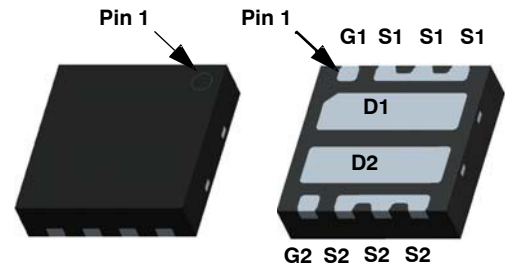

Power 33

WDFN8 3x3, 0.65P  
CASE 511DG

### MARKING DIAGRAM

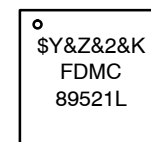

\$Y = onsemi Logo  
&Z = Assembly Plant Code  
&2 = Numeric Date Code  
&K = Lot Code  
FDMC89521L = Specific Device Code

### PIN ASSIGNMENT

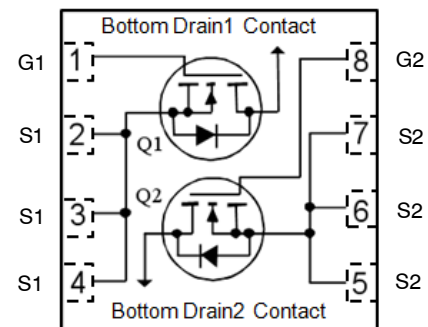

N-Channel MOSFET

### ORDERING INFORMATION

See detailed ordering and shipping information on page 6 of this data sheet.

# FDMC89521L

## ELECTRICAL CHARACTERISTICS (T<sub>A</sub> = 25°C unless otherwise noted)

Parameter	Test Conditions	Symbol	Min.	Typ.	Max.	Unit
-----------	-----------------	--------	------	------	------	------

### OFF CHARACTERISTICS

BV <sub>DSS</sub>	Drain to Source Breakdown Voltage	I <sub>D</sub> = 250 μA, V <sub>GS</sub> = 0 V	60			V
$\frac{\Delta BV_{DSS}}{\Delta T_J}$	Breakdown Voltage Temperature Coefficient	I <sub>D</sub> = 250 μA, referenced to 25°C		30		mV/°C
I <sub>DSS</sub>	Zero Gate Voltage Drain Current	V <sub>DS</sub> = 48 V, V <sub>GS</sub> = 0 V			1	μA
I <sub>GSS</sub>	Gate to Source Leakage Current	V <sub>GS</sub> = ±20 V, V <sub>DS</sub> = 0 V			±100	nA

### ON CHARACTERISTICS

V <sub>GS(th)</sub>	Gate to Source Threshold Voltage	V <sub>GS</sub> = V <sub>DS</sub> , I <sub>D</sub> = 250 μA	1	1.9	3	V
$\frac{\Delta V_{GS(th)}}{\Delta T_J}$	Gate to Source Threshold Voltage Temperature Coefficient	I <sub>D</sub> = 250 μA, referenced to 25°C		-6		mV/°C
r <sub>DS(on)</sub>	Static Drain to Source On Resistance	V <sub>GS</sub> = 10 V, I <sub>D</sub> = 8.2 A		13	17	mΩ
		V <sub>GS</sub> = 4.5 V, I <sub>D</sub> = 6.7 A		21	27	
		V <sub>GS</sub> = 10 V, I <sub>D</sub> = 8.2 A, T <sub>J</sub> = 125°C		20	26	
g <sub>FS</sub>	Forward Transconductance	V <sub>DD</sub> = 10 V, I <sub>D</sub> = 8.2 A		28		S

### DYNAMIC CHARACTERISTICS

C <sub>iss</sub>	Input Capacitance	V <sub>DS</sub> = 30 V, V <sub>GS</sub> = 0 V f = 1 MHz		1228	1635	pF
C <sub>oss</sub>	Output Capacitance			243	325	
C <sub>rss</sub>	Reverse Transfer Capacitance			10	15	
R <sub>g</sub>	Gate Resistance			0.7		

### SWITCHING CHARACTERISTICS

t <sub>d(on)</sub>	Turn-On Delay Time	V <sub>DD</sub> = 30 V, I <sub>D</sub> = 8.2 A, V <sub>GS</sub> = 10 V, R <sub>GEN</sub> = 6 Ω		7.9	16	ns
t <sub>r</sub>	Rise Time			2.1	10	
t <sub>d(off)</sub>	Turn-Off Delay Time			18	33	
t <sub>f</sub>	Fall Time			1.7	10	
Q <sub>g</sub>	Total Gate Charge	V <sub>GS</sub> = 0 V to 10 V, V <sub>DD</sub> = 30 V, I <sub>D</sub> = 8.2 A		17	24	nC
		V <sub>GS</sub> = 0 V to 4.5 V, V <sub>DD</sub> = 30 V, I <sub>D</sub> = 8.2 A		7.9	12	
Q <sub>gs</sub>	Gate to Source Charge	V <sub>DD</sub> = 30 V, I <sub>D</sub> = 8.2 A		3.8		nC
Q <sub>gd</sub>	Gate to Drain "Miller" Charge			1.9		

### DRAIN-SOURCE DIODE CHARACTERISTICS

V <sub>SD</sub>	Source to Drain Diode Forward Voltage	V <sub>GS</sub> = 0 V, I <sub>S</sub> = 8.2 A (Note 2)		0.85	1.3	V
		V <sub>GS</sub> = 0 V, I <sub>S</sub> = 1.6 A (Note 2)		0.75	1.2	
t <sub>rr</sub>	Reverse Recovery Time	I <sub>F</sub> = 8.2 A, di/dt = 100 A/μs		25	40	ns
Q <sub>rr</sub>	Reverse Recovery Charge			11	20	nC

Product parametric performance is indicated in the Electrical Characteristics for the listed test conditions, unless otherwise noted. Product performance may not be indicated by the Electrical Characteristics if operated under different conditions.

# FDMC89521L

NOTES:

- 1.  $R_{\theta JA}$  is determined with the device mounted on a 1 in<sup>2</sup> pad 2 oz copper pad on a 1.5 x 1.5 in. board of FR-4 material.  $R_{\theta JC}$  is guaranteed by design while  $R_{\theta CA}$  is determined by the user's board design.

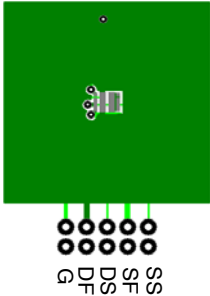

a. 65°C/W when mounted on a 1 in<sup>2</sup> pad of 2 oz copper

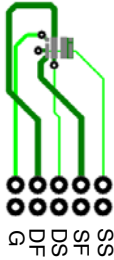

b. 155°C/W when mounted on a minimum pad of 2 oz copper

- 2. Pulse Test: Pulse Width < 300 μs, Duty cycle < 2.0%.
- 3.  $E_{AS}$  of 32 mJ is based on starting  $T_J = 25^\circ\text{C}$ ,  $L = 1\text{ mH}$ ,  $I_{AS} = 8\text{ A}$ ,  $V_{DD} = 54\text{ V}$ ,  $V_{GS} = 10\text{ V}$ . 100% tested at  $L = 3\text{ mH}$ ,  $I_{AS} = 5.4\text{ A}$ .

TYPICAL CHARACTERISTICS ( $T_J = 25^\circ\text{C}$  unless otherwise noted)

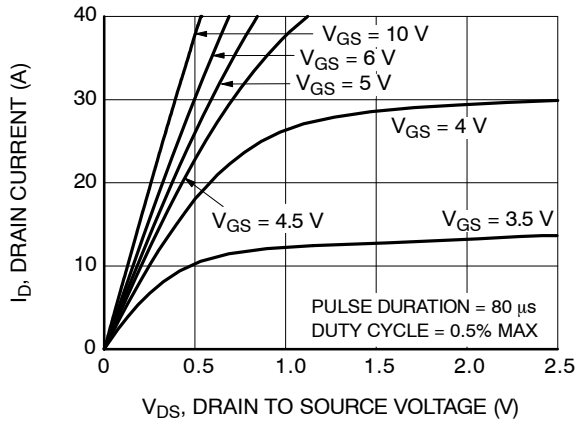

Figure 1. On-Region Characteristics

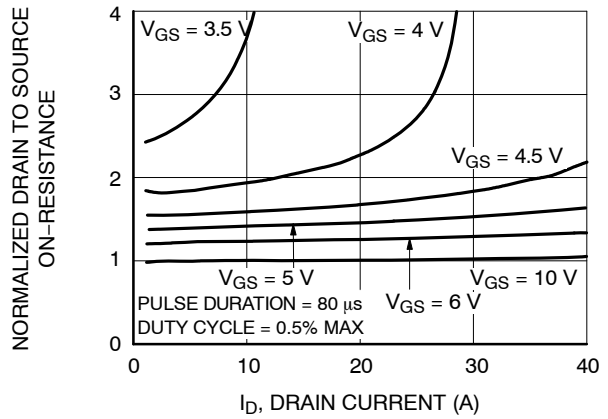

Figure 2. Normalized On-Resistance vs. Drain Current and Gate Voltage

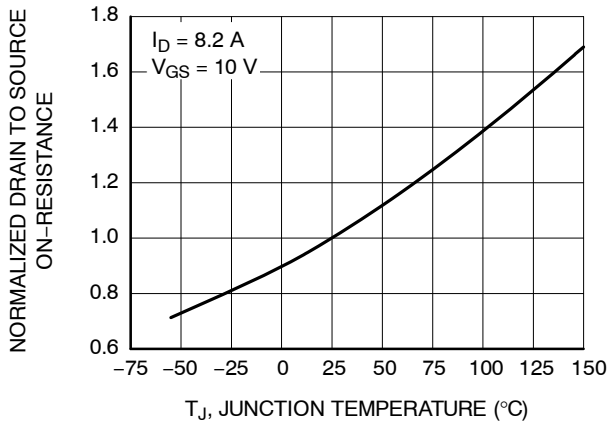

Figure 3. Normalized On-Resistance vs. Junction Temperature

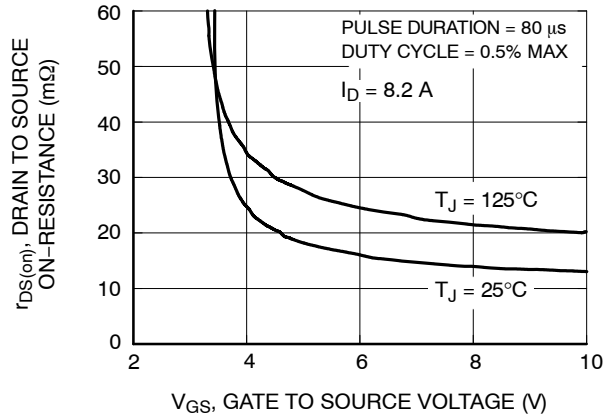

Figure 4. On-Resistance vs. Gate to Source Voltage

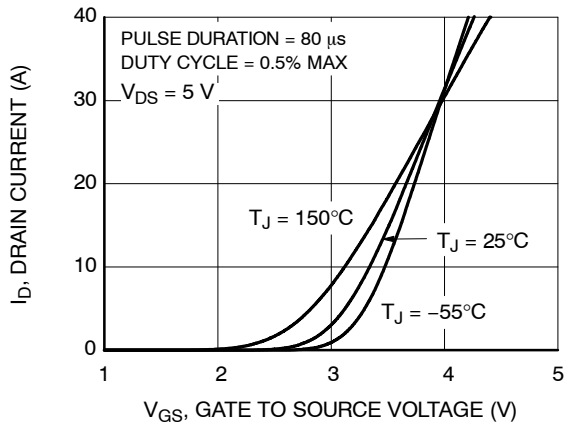

Figure 5. Transfer Characteristics

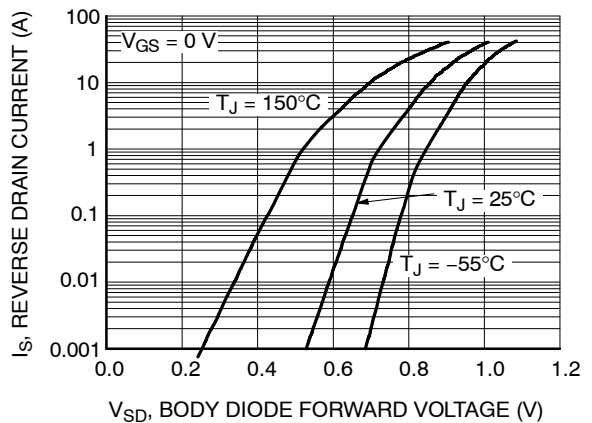

Figure 6. Source to Drain Diode Forward Voltage vs. Source Current

TYPICAL CHARACTERISTICS ( $T_J = 25^\circ\text{C}$  unless otherwise noted) (continued)

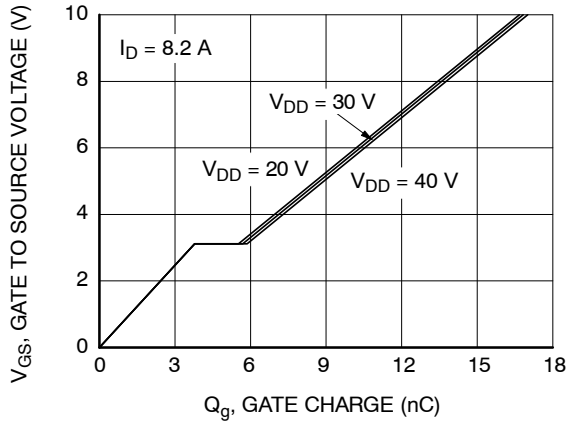

Figure 7. Gate Charge Characteristics

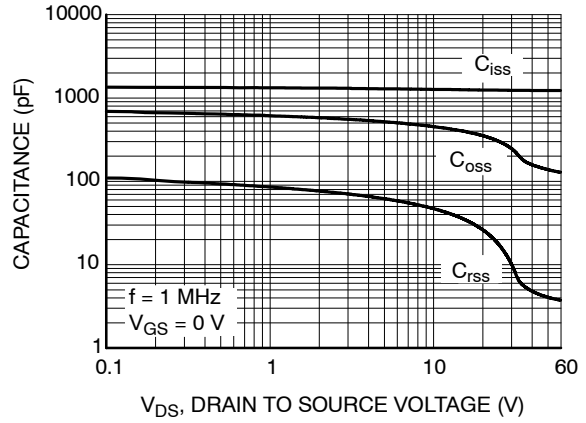

Figure 8. Capacitance vs. Drain to Source Voltage

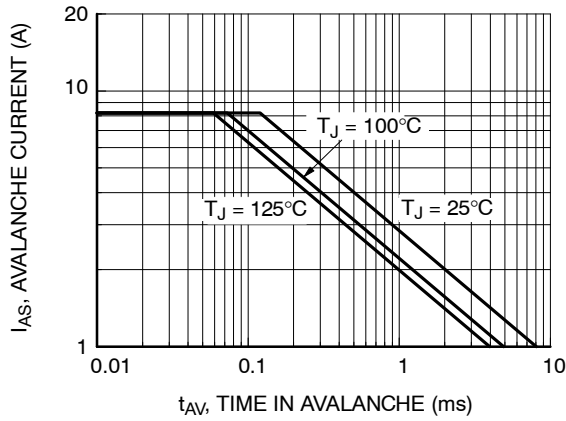

Figure 9. Unclamped Inductive Switching Capability

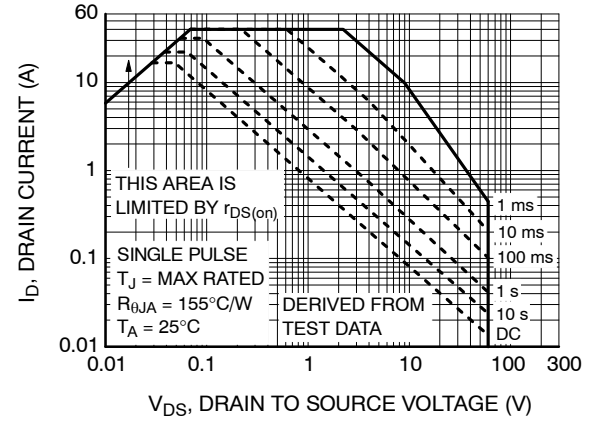

Figure 10. Maximum Continuous Drain Current vs. Case Temperature

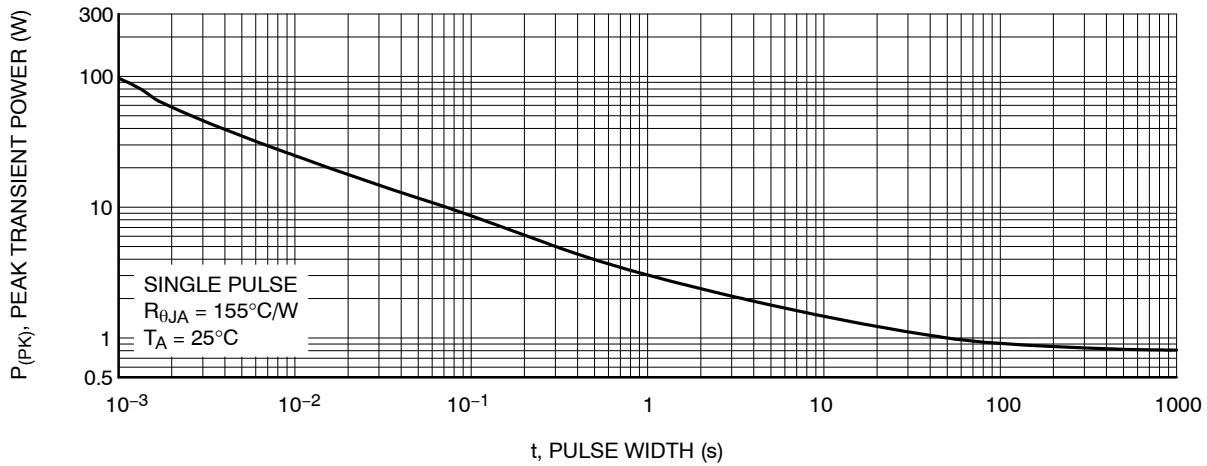
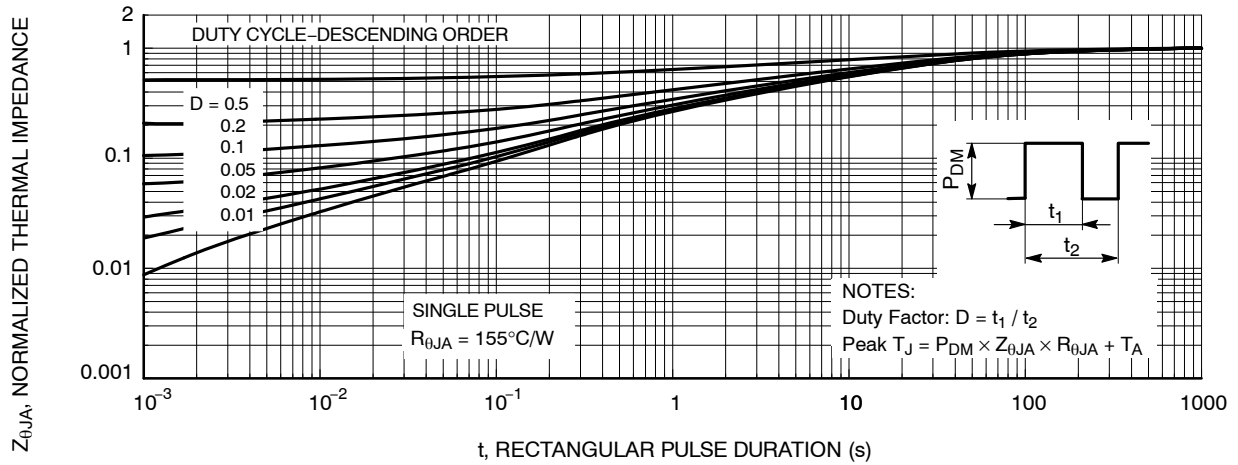

Figure 11. Single Pulse Maximum Power Dissipation

# FDMC89521L

## TYPICAL CHARACTERISTICS ( $T_J = 25^\circ\text{C}$ unless otherwise noted) (continued)



**Figure 12. Junction-to-Case Transient Thermal Response Curve**

### ORDERING INFORMATION

Device	Device Marking	Package Type	Shipping <sup>†</sup>
FDMC89521L	FDMC89521L	WDFN8 3x3, 0.65P (Pb-Free)	3000 / Tape & Reel

<sup>†</sup>For information on tape and reel specifications, including part orientation and tape sizes, please refer to our Tape and Reel Packaging Specifications Brochure, BRD8011/D.

**WDFN8 3x3, 0.65P**  
**CASE 511DG**  
**ISSUE A**

DATE 12 FEB 2019

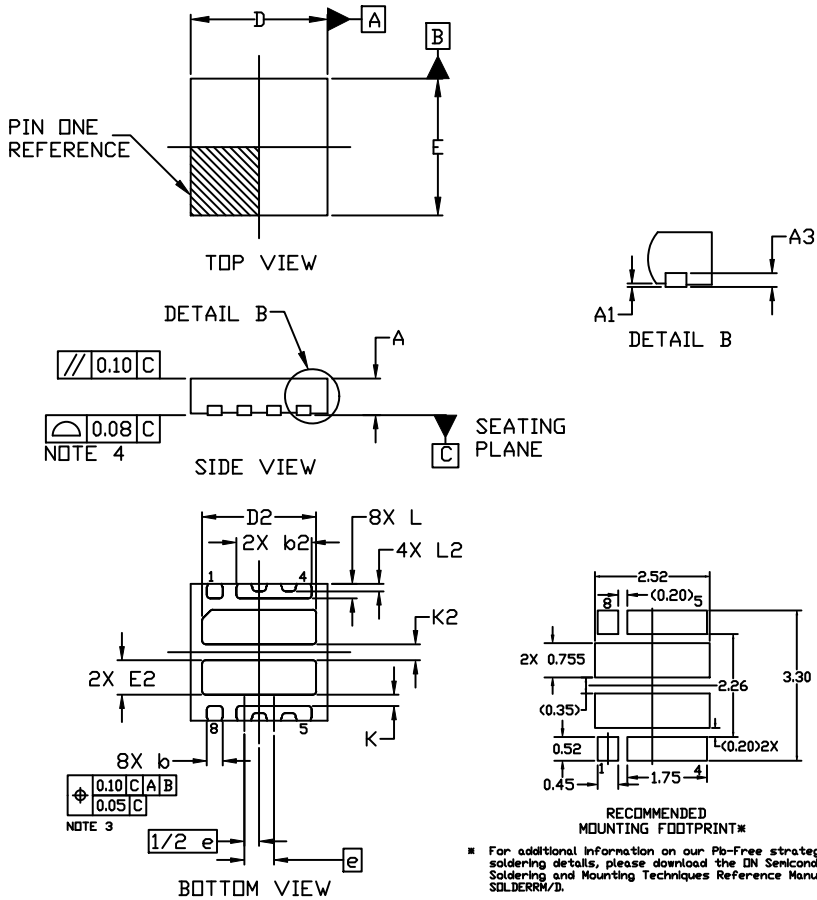

NOTES:

1. DIMENSIONING AND TOLERANCING PER ASME Y14.5M, 2009.
2. CONTROLLING DIMENSION: MILLIMETERS
3. DIMENSION *b* APPLIES TO PLATED TERMINALS AND IS MEASURED BETWEEN 0.15 AND 0.30MM FROM THE TERMINAL TIP.
4. COPLANARITY APPLIES TO THE EXPOSED PAD AS WELL AS THE TERMINALS.

DIM	MILLIMETERS		
	MIN.	NOM.	MAX.
A	0.70	0.75	0.80
A1	0.00	---	0.05
A3	0.20 REF		
<i>b</i>	0.30	0.35	0.40
<i>b</i> 2	1.65 REF		
D	2.90	3.00	3.10
D2	2.45	2.50	2.55
E	2.90	3.00	3.10
E2	1.40	1.50	1.60
<i>e</i>	0.65 BSC		
K	0.25	---	---
K2	0.35 REF		
L	0.27	0.32	0.37
L2	0.163 REF		

**GENERIC MARKING DIAGRAM\***

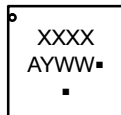

XXXX = Specific Device Code  
 A = Assembly Location  
 Y = Year  
 WW = Work Week  
 ■ = Pb-Free Package

(Note: Microdot may be in either location)

\*This information is generic. Please refer to device data sheet for actual part marking. Pb-Free indicator, "G" or microdot "■", may or may not be present. Some products may not follow the Generic Marking.

<b>DOCUMENT NUMBER:</b>	<b>98AON13623G</b>	Electronic versions are uncontrolled except when accessed directly from the Document Repository. Printed versions are uncontrolled except when stamped "CONTROLLED COPY" in red.
<b>DESCRIPTION:</b>	<b>WDFN8 3x3, 0.65P</b>	<b>PAGE 1 OF 1</b>

ON Semiconductor and **ON** are trademarks of Semiconductor Components Industries, LLC dba ON Semiconductor or its subsidiaries in the United States and/or other countries. ON Semiconductor reserves the right to make changes without further notice to any products herein. ON Semiconductor makes no warranty, representation or guarantee regarding the suitability of its products for any particular purpose, nor does ON Semiconductor assume any liability arising out of the application or use of any product or circuit, and specifically disclaims any and all liability, including without limitation special, consequential or incidental damages. ON Semiconductor does not convey any license under its patent rights nor the rights of others.

**onsemi**, **Onsemi**, and other names, marks, and brands are registered and/or common law trademarks of Semiconductor Components Industries, LLC dba "**onsemi**" or its affiliates and/or subsidiaries in the United States and/or other countries. **onsemi** owns the rights to a number of patents, trademarks, copyrights, trade secrets, and other intellectual property. A listing of **onsemi**'s product/patent coverage may be accessed at [www.onsemi.com/site/pdf/Patent-Marking.pdf](http://www.onsemi.com/site/pdf/Patent-Marking.pdf). **onsemi** reserves the right to make changes at any time to any products or information herein, without notice. The information herein is provided "as-is" and **onsemi** makes no warranty, representation or guarantee regarding the accuracy of the information, product features, availability, functionality, or suitability of its products for any particular purpose, nor does **onsemi** assume any liability arising out of the application or use of any product or circuit, and specifically disclaims any and all liability, including without limitation special, consequential or incidental damages. Buyer is responsible for its products and applications using **onsemi** products, including compliance with all laws, regulations and safety requirements or standards, regardless of any support or applications information provided by **onsemi**. "Typical" parameters which may be provided in **onsemi** data sheets and/or specifications can and do vary in different applications and actual performance may vary over time. All operating parameters, including "Typicals" must be validated for each customer application by customer's technical experts. **onsemi** does not convey any license under any of its intellectual property rights nor the rights of others. **onsemi** products are not designed, intended, or authorized for use as a critical component in life support systems or any FDA Class 3 medical devices or medical devices with a same or similar classification in a foreign jurisdiction or any devices intended for implantation in the human body. Should Buyer purchase or use **onsemi** products for any such unintended or unauthorized application, Buyer shall indemnify and hold **onsemi** and its officers, employees, subsidiaries, affiliates, and distributors harmless against all claims, costs, damages, and expenses, and reasonable attorney fees arising out of, directly or indirectly, any claim of personal injury or death associated with such unintended or unauthorized use, even if such claim alleges that **onsemi** was negligent regarding the design or manufacture of the part. **onsemi** is an Equal Opportunity/Affirmative Action Employer. This literature is subject to all applicable copyright laws and is not for resale in any manner.

---

## ADDITIONAL INFORMATION

### TECHNICAL PUBLICATIONS:

Technical Library: [www.onsemi.com/design/resources/technical-documentation](http://www.onsemi.com/design/resources/technical-documentation)  
onsemi Website: [www.onsemi.com](http://www.onsemi.com)

### ONLINE SUPPORT: [www.onsemi.com/support](http://www.onsemi.com/support)

For additional information, please contact your local Sales Representative at [www.onsemi.com/support/sales](http://www.onsemi.com/support/sales)

