

# FDFS6N548

## Integrated N-Channel POWERTRENCH<sup>®</sup> MOSFET and Schottky Diode

### Description

The FDFS6N548 combines the exceptional performance of ON Semiconductor's PowerTrench MOSFET technology with a very low forward voltage drop Schottky barrier rectifier in an SO-8 package.

This device is designed specifically as a single package solution for DC to DC converters. It features a fast switching, low gate charge MOSFET with very low on-state resistance. The independently connected Schottky diode allows its use in a variety of DC/DC converter topologies.

### Features

- Max  $r_{DS(on)}$  = 23 mΩ at  $V_{GS} = 10\text{ V}$ ,  $I_D = 7\text{ A}$
- Max  $r_{DS(on)}$  = 30 mΩ at  $V_{GS} = 4.5\text{ V}$ ,  $I_D = 6\text{ A}$
- $V_F < 0.45\text{ V @ } 2\text{ A}$   
 $V_F < 0.28\text{ V @ } 100\text{ mA}$
- Schottky and MOSFET Incorporated into Single Power Surface Mount SO-8 Package
- Electrically Independent Schottky and MOSFET Pinout for Design Flexibility
- Low Miller Charge

### Application

- DC/DC Conversion

### MAXIMUM RATINGS (T<sub>A</sub> = 25°C unless otherwise noted)

Symbol	Parameter	Value	Unit
V <sub>DS</sub>	Drain-to-Source Voltage	30	V
V <sub>GS</sub>	Gate-to-Source Voltage	±20	V
I <sub>D</sub>	Drain Current	Continuous (Note 1a)	7
		Pulsed	30
P <sub>D</sub>	Power Dissipation	Dual Operation	2
		Single Operation (Note 1a)	1.6
E <sub>AS</sub>	Drain-Source Avalanche Energy (Note 3)	12	mJ
V <sub>R</sub> RM	Schottky Repetitive Peak Reverse Voltage	30	V
I <sub>O</sub>	Schottky Average Forward Current (Note 1a)	2	A
T <sub>J</sub> , T <sub>STG</sub>	Operating and Storage Junction Temperature Range	-55 to +150	°C

Stresses exceeding those listed in the Maximum Ratings table may damage the device. If any of these limits are exceeded, device functionality should not be assumed, damage may occur and reliability may be affected.

### THERMAL CHARACTERISTICS

Symbol	Parameter	Value	Unit
R <sub>θJA</sub>	Thermal Resistance, Junction-to-Ambient (Note 1a)	78	°C/W
R <sub>θJC</sub>	Thermal Resistance, Junction-to-Case (Note 1)	40	°C/W



ON Semiconductor<sup>®</sup>

[www.onsemi.com](http://www.onsemi.com)

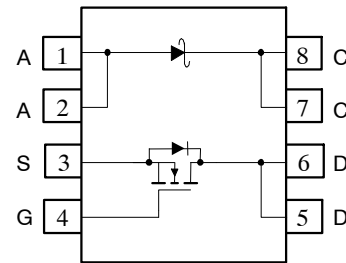
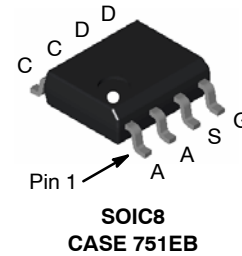

### ORDERING INFORMATION

See detailed ordering and shipping information on page 6 of this data sheet.

# FDFS6N548

## ELECTRICAL CHARACTERISTICS (T<sub>J</sub> = 25°C unless otherwise noted)

Symbol	Parameter	Test Conditions	Min	Typ	Max	Unit
<b>OFF CHARACTERISTICS</b>						
B <sub>V</sub> DSS	Drain-to-Source Breakdown Voltage	V <sub>GS</sub> = 0 V, I <sub>D</sub> = 250 μA	30			V
ΔB <sub>V</sub> DSS/ ΔT <sub>J</sub>	Breakdown Voltage Temperature Coefficient	I <sub>D</sub> = 250 μA, Referenced to 25°C		22		mV/°C
I <sub>DSS</sub>	Zero Gate Voltage Drain Current	V <sub>GS</sub> = 0 V, V <sub>DS</sub> = 24 V			1	μA
		V <sub>GS</sub> = 0 V, V <sub>DS</sub> = 24 V, T <sub>J</sub> = 125°C			250	
I <sub>GSS</sub>	Gate-to-Source Leakage Current	V <sub>GS</sub> = ±20 V, V <sub>DS</sub> = 0 V			±100	nA

## ON CHARACTERISTICS

V <sub>GS(th)</sub>	Gate-to-Source Threshold Voltage	V <sub>DS</sub> = V <sub>GS</sub> , I <sub>D</sub> = 250 μA	1.2	1.8	2.5	V
ΔV <sub>GS(th)</sub> / ΔT <sub>J</sub>	Gate-to-Source Threshold Voltage Temperature Coefficient	I <sub>D</sub> = 250 μA, Referenced to 25°C		-5		mV/°C
R <sub>DS(on)</sub>	Drain-to-Source On-Resistance	V <sub>GS</sub> = 10 V, I <sub>D</sub> = 7 A		19	23	mΩ
		V <sub>GS</sub> = 4.5 V, I <sub>D</sub> = 6 A		23	30	
		V <sub>GS</sub> = 10 V, I <sub>D</sub> = 7 A, T <sub>J</sub> = 125°C		26	31	
g <sub>FS</sub>	Forward Transconductance	V <sub>DS</sub> = 5 V, I <sub>D</sub> = 7 A		20		S

## DYNAMIC CHARACTERISTICS

C <sub>iss</sub>	Input Capacitance	V <sub>DS</sub> = 15 V, V <sub>GS</sub> = 0 V, f = 1 MHz		525	700	pF
C <sub>oss</sub>	Output Capacitance			100	133	pF
C <sub>rss</sub>	Reverse Transfer Capacitance			65	100	pF
R <sub>g</sub>	Gate Resistance	f = 1 MHz		0.8		Ω

## SWITCHING CHARACTERISTICS

t <sub>d(on)</sub>	Turn-On Delay Time	V <sub>DD</sub> = 15 V, I <sub>D</sub> = 7 A, V <sub>GS</sub> = 10 V, R <sub>GEN</sub> = 6 Ω		6	12	ns
t <sub>r</sub>	Rise Time			2	10	ns
t <sub>d(off)</sub>	Turn-Off Delay Time			14	25	ns
t <sub>f</sub>	Fall Time			2	10	ns
Q <sub>g(TOT)</sub>	Total Gate Charge at 10 V	V <sub>DS</sub> = 15 V, I <sub>D</sub> = 7 A, V <sub>GS</sub> = 10 V		9	13	nC
Q <sub>gs</sub>	Gate-to-Source Gate Charge			1.5		nC
Q <sub>gd</sub>	Gate-to-Drain "Miller" Charge			2		nC

## DRAIN-SOURCE DIODE CHARACTERISTICS

V <sub>SD</sub>	Source-to-Drain Diode Forward Voltage	V <sub>GS</sub> = 0 V, I <sub>S</sub> = 7 A (Note 2)		0.90	1.25	V
t <sub>rr</sub>	Reverse Recovery Time	I <sub>F</sub> = 7 A, di/dt = 100 A/μs		23	35	ns
Q <sub>rr</sub>	Reverse Recovery Charge			14	21	nC

## SCHOTTKY DIODE CHARACTERISTICS

V <sub>R</sub>	Reverse Breakdown Voltage	I <sub>R</sub> = -1 mA	-30			V
I <sub>R</sub>	Reverse Leakage	V <sub>R</sub> = -10 V	T <sub>J</sub> = 25°C	-39	-250	μA
			T <sub>J</sub> = 125°C	-18		mA
V <sub>F</sub>	Forward Voltage	I <sub>F</sub> = 100 mA	T <sub>J</sub> = 25°C	225	280	mV
			T <sub>J</sub> = 125°C	140		
		I <sub>F</sub> = 2 A	T <sub>J</sub> = 25°C	364	450	
			T <sub>J</sub> = 125°C	290		

Product parametric performance is indicated in the Electrical Characteristics for the listed test conditions, unless otherwise noted. Product performance may not be indicated by the Electrical Characteristics if operated under different conditions.

## FDFS6N548

1.  $R_{\theta JA}$  is the sum of the junction-to-case and case-to-ambient thermal resistance where the case thermal reference is defined as the solder mounting surface of the drain pins.  $R_{\theta JC}$  is guaranteed by design while  $R_{\theta CA}$  is determined by the user's board design.

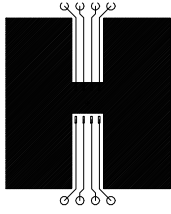

a) 78°C/W when mounted on a 0.5 in<sup>2</sup> pad of 2 oz copper

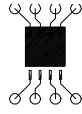

b) 125°C/W when mounted on a 0.02 in<sup>2</sup> pad of 2 oz copper

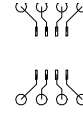

c) 135°C/W when mounted on a minimum pad

2. Pulse Test: Pulse Width < 300  $\mu$ s, Duty Cycle < 2.0%.  
3. Starting  $T_J = 25^\circ\text{C}$ ,  $L = 1$  mH,  $I_{AS} = 5.0$  A,  $V_{DD} = 27$  V,  $V_{GS} = 10$  V.

TYPICAL CHARACTERISTICS ( $T_J = 25^\circ\text{C}$  unless otherwise noted)

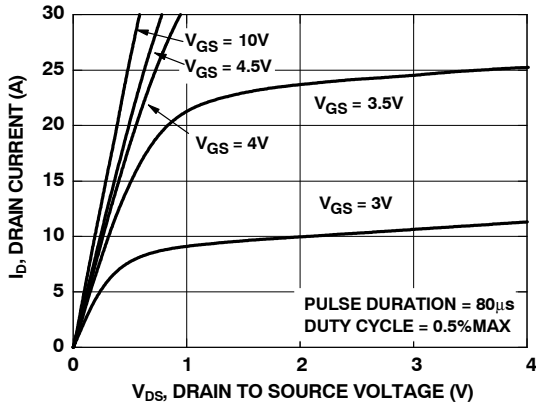

Figure 1. On Region Characteristics

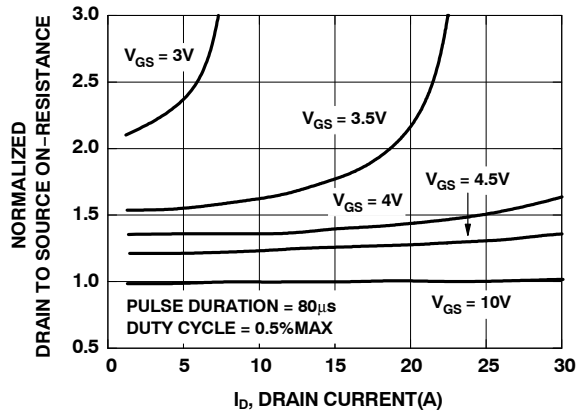

Figure 2. Normalized On-Resistance vs. Drain Current and Gate Voltage

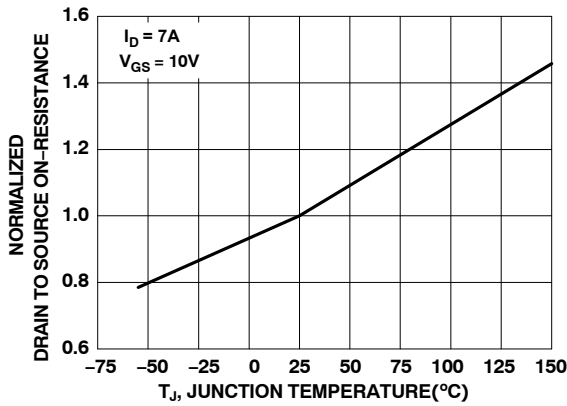

Figure 3. Normalized On-Resistance vs. Junction Temperature

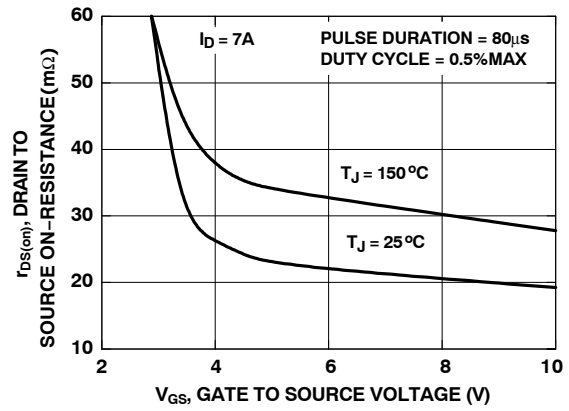

Figure 4. On-Resistance vs. Gate-to-Source Voltage

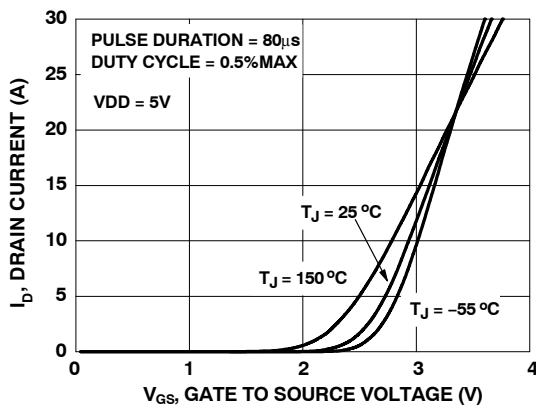

Figure 5. Transfer Characteristics

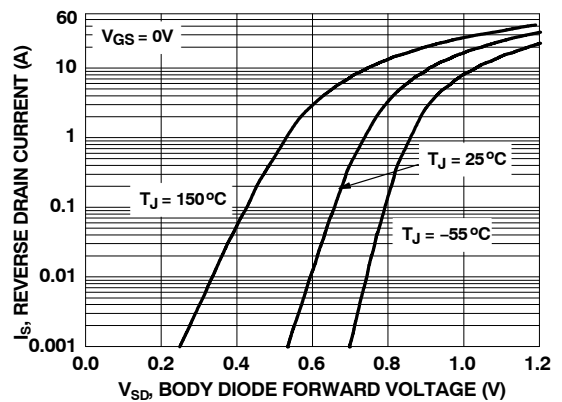

Figure 6. Source-to-Drain Diode Forward Voltage vs. Source Current

TYPICAL CHARACTERISTICS ( $T_J = 25^\circ\text{C}$  unless otherwise noted)

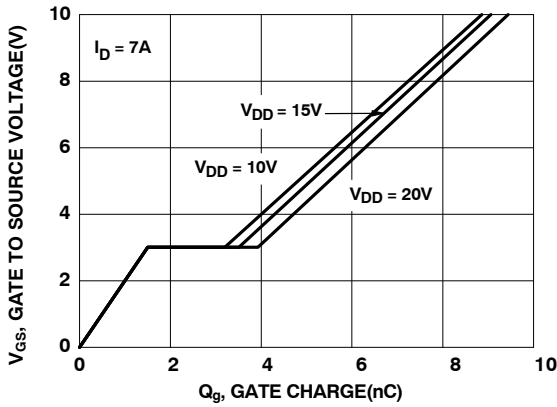

Figure 7. Gate Charge Characteristics

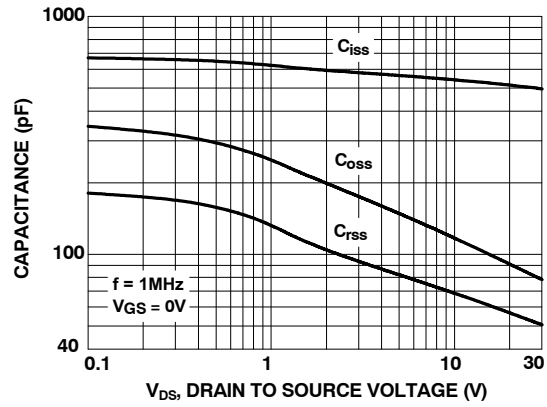

Figure 8. Capacitance vs. Drain-to-Source Voltage

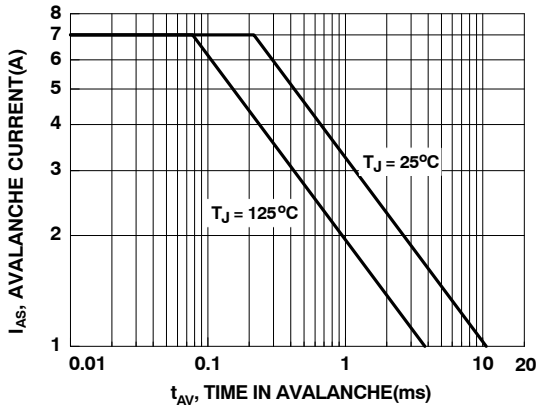

Figure 9. Unclamped Inductive Switching Capability

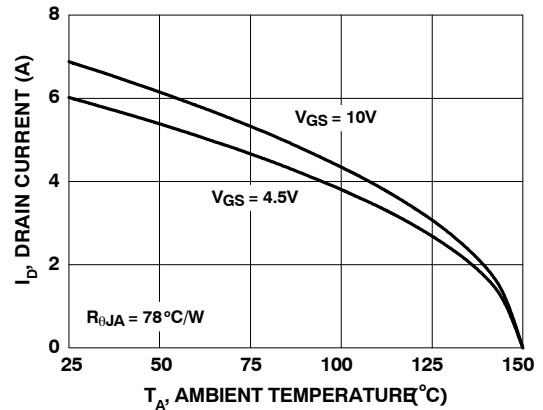

Figure 10. Maximum Continuous Drain Current vs. Ambient Temperature

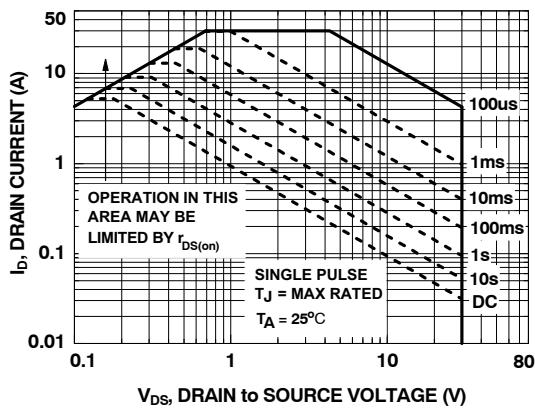

Figure 11. Forward Bias Safe Operating Area

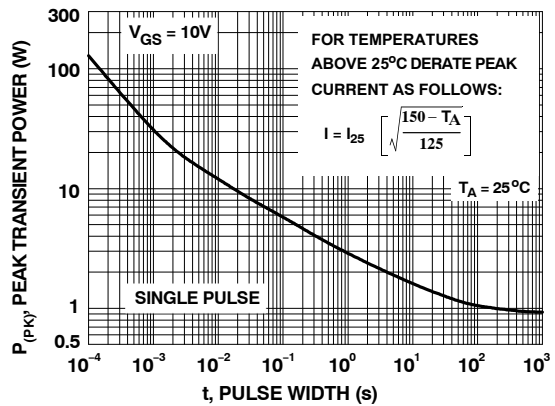

Figure 12. Single Pulse Maximum Power Dissipation

# FDFS6N548

## TYPICAL CHARACTERISTICS ( $T_J = 25^\circ\text{C}$ unless otherwise noted)

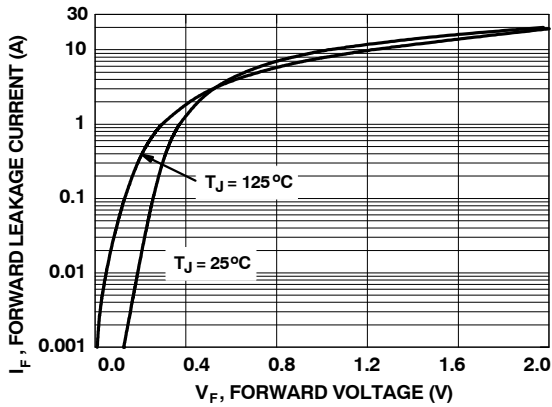

Figure 13. Schottky Diode Forward Characteristics

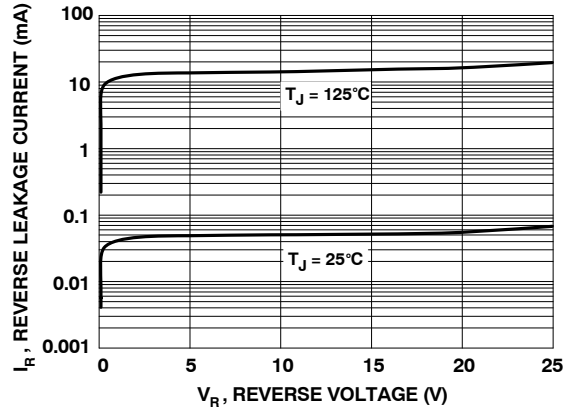

Figure 14. Schottky Diode Reverse Characteristics

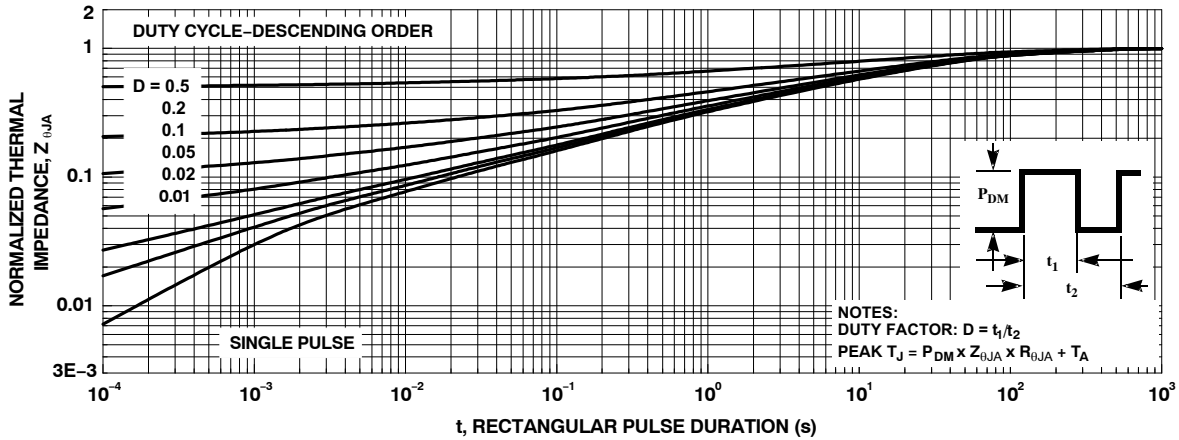

Figure 15. Transient Thermal Response Curve

### PACKAGE MARKING AND ORDERING INFORMATION

Device Marking	Device	Package	Reel Size	Tape Width	Shipping†
FDFS6N548	FDFS6N548	SO-8	330 mm	12 mm	2500 / Tape & Reel

†For information on tape and reel specifications, including part orientation and tape sizes, please refer to our Tape and Reel Packaging Specifications Brochure, BRD8011/D.

**MECHANICAL CASE OUTLINE**  
**PACKAGE DIMENSIONS**

ON Semiconductor®



**SOIC8**  
**CASE 751EB**  
**ISSUE A**

DATE 24 AUG 2017

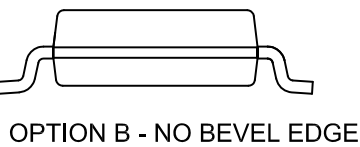
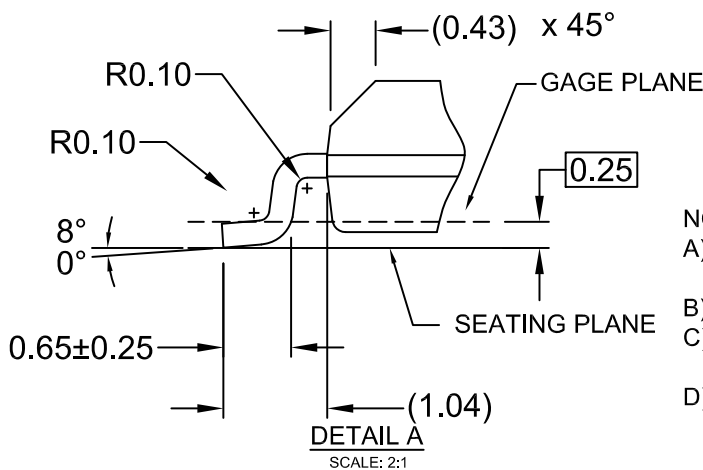
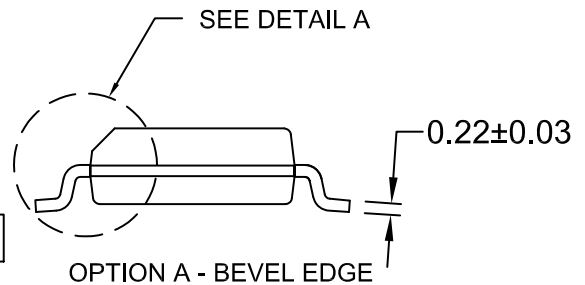
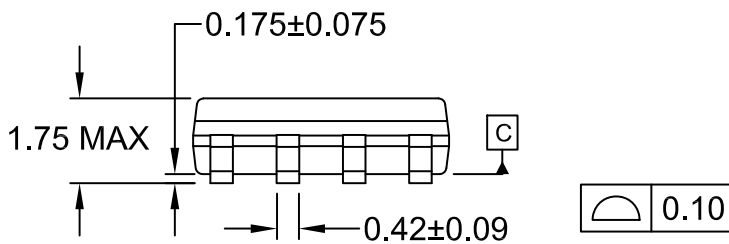
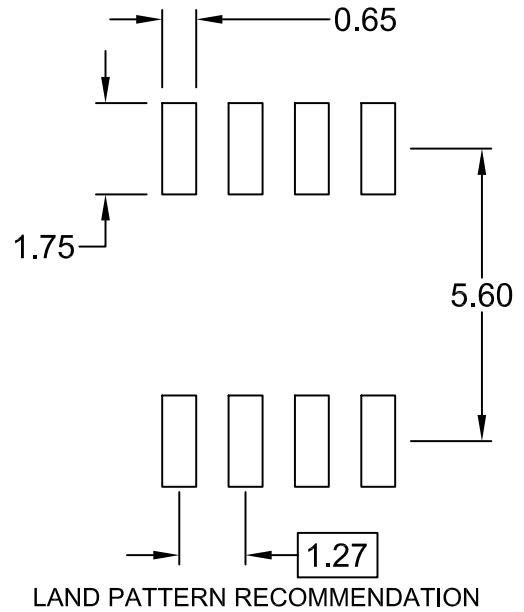
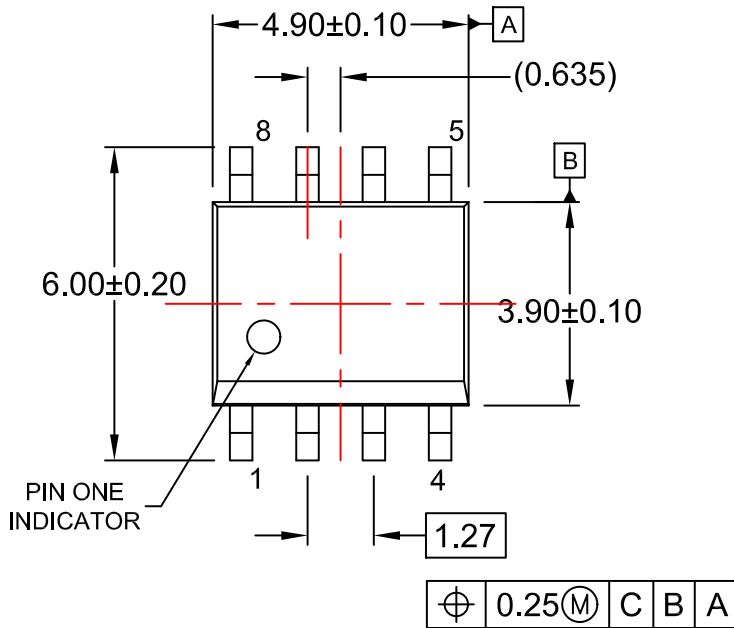

- NOTES:  
 A) THIS PACKAGE CONFORMS TO JEDEC MS-012, VARIATION AA.  
 B) ALL DIMENSIONS ARE IN MILLIMETERS.  
 C) DIMENSIONS DO NOT INCLUDE MOLD FLASH OR BURRS.  
 D) LANDPATTERN STANDARD: SOIC127P600X175-8M

<b>DOCUMENT NUMBER:</b>	<b>98AON13735G</b>	Electronic versions are uncontrolled except when accessed directly from the Document Repository. Printed versions are uncontrolled except when stamped "CONTROLLED COPY" in red.
<b>DESCRIPTION:</b>	<b>SOIC8</b>	<b>PAGE 1 OF 1</b>

ON Semiconductor and ON are trademarks of Semiconductor Components Industries, LLC dba ON Semiconductor or its subsidiaries in the United States and/or other countries. ON Semiconductor reserves the right to make changes without further notice to any products herein. ON Semiconductor makes no warranty, representation or guarantee regarding the suitability of its products for any particular purpose, nor does ON Semiconductor assume any liability arising out of the application or use of any product or circuit, and specifically disclaims any and all liability, including without limitation special, consequential or incidental damages. ON Semiconductor does not convey any license under its patent rights nor the rights of others.

**onsemi**, **Onsemi**, and other names, marks, and brands are registered and/or common law trademarks of Semiconductor Components Industries, LLC dba "**onsemi**" or its affiliates and/or subsidiaries in the United States and/or other countries. **onsemi** owns the rights to a number of patents, trademarks, copyrights, trade secrets, and other intellectual property. A listing of **onsemi**'s product/patent coverage may be accessed at [www.onsemi.com/site/pdf/Patent-Marking.pdf](http://www.onsemi.com/site/pdf/Patent-Marking.pdf). **onsemi** reserves the right to make changes at any time to any products or information herein, without notice. The information herein is provided "as-is" and **onsemi** makes no warranty, representation or guarantee regarding the accuracy of the information, product features, availability, functionality, or suitability of its products for any particular purpose, nor does **onsemi** assume any liability arising out of the application or use of any product or circuit, and specifically disclaims any and all liability, including without limitation special, consequential or incidental damages. Buyer is responsible for its products and applications using **onsemi** products, including compliance with all laws, regulations and safety requirements or standards, regardless of any support or applications information provided by **onsemi**. "Typical" parameters which may be provided in **onsemi** data sheets and/or specifications can and do vary in different applications and actual performance may vary over time. All operating parameters, including "Typicals" must be validated for each customer application by customer's technical experts. **onsemi** does not convey any license under any of its intellectual property rights nor the rights of others. **onsemi** products are not designed, intended, or authorized for use as a critical component in life support systems or any FDA Class 3 medical devices or medical devices with a same or similar classification in a foreign jurisdiction or any devices intended for implantation in the human body. Should Buyer purchase or use **onsemi** products for any such unintended or unauthorized application, Buyer shall indemnify and hold **onsemi** and its officers, employees, subsidiaries, affiliates, and distributors harmless against all claims, costs, damages, and expenses, and reasonable attorney fees arising out of, directly or indirectly, any claim of personal injury or death associated with such unintended or unauthorized use, even if such claim alleges that **onsemi** was negligent regarding the design or manufacture of the part. **onsemi** is an Equal Opportunity/Affirmative Action Employer. This literature is subject to all applicable copyright laws and is not for resale in any manner.

---

## ADDITIONAL INFORMATION

### TECHNICAL PUBLICATIONS:

Technical Library: [www.onsemi.com/design/resources/technical-documentation](http://www.onsemi.com/design/resources/technical-documentation)  
onsemi Website: [www.onsemi.com](http://www.onsemi.com)

### ONLINE SUPPORT: [www.onsemi.com/support](http://www.onsemi.com/support)

For additional information, please contact your local Sales Representative at [www.onsemi.com/support/sales](http://www.onsemi.com/support/sales)