



Is Now Part of



**ON Semiconductor®**

To learn more about ON Semiconductor, please visit our website at  
[www.onsemi.com](http://www.onsemi.com)

Please note: As part of the Fairchild Semiconductor integration, some of the Fairchild orderable part numbers will need to change in order to meet ON Semiconductor's system requirements. Since the ON Semiconductor product management systems do not have the ability to manage part nomenclature that utilizes an underscore (\_), the underscore (\_) in the Fairchild part numbers will be changed to a dash (-). This document may contain device numbers with an underscore (\_). Please check the ON Semiconductor website to verify the updated device numbers. The most current and up-to-date ordering information can be found at [www.onsemi.com](http://www.onsemi.com). Please email any questions regarding the system integration to [Fairchild\\_questions@onsemi.com](mailto:Fairchild_questions@onsemi.com).

ON Semiconductor and the ON Semiconductor logo are trademarks of Semiconductor Components Industries, LLC dba ON Semiconductor or its subsidiaries in the United States and/or other countries. ON Semiconductor owns the rights to a number of patents, trademarks, copyrights, trade secrets, and other intellectual property. A listing of ON Semiconductor's product/patent coverage may be accessed at [www.onsemi.com/site/pdf/Patent-Marking.pdf](http://www.onsemi.com/site/pdf/Patent-Marking.pdf). ON Semiconductor reserves the right to make changes without further notice to any products herein. ON Semiconductor makes no warranty, representation or guarantee regarding the suitability of its products for any particular purpose, nor does ON Semiconductor assume any liability arising out of the application or use of any product or circuit, and specifically disclaims any and all liability, including without limitation special, consequential or incidental damages. Buyer is responsible for its products and applications using ON Semiconductor products, including compliance with all laws, regulations and safety requirements or standards, regardless of any support or applications information provided by ON Semiconductor. "Typical" parameters which may be provided in ON Semiconductor data sheets and/or specifications can and do vary in different applications and actual performance may vary over time. All operating parameters, including "Typicals" must be validated for each customer application by customer's technical experts. ON Semiconductor does not convey any license under its patent rights nor the rights of others. ON Semiconductor products are not designed, intended, or authorized for use as a critical component in life support systems or any FDA Class 3 medical devices or medical devices with a same or similar classification in a foreign jurisdiction or any devices intended for implantation in the human body. Should Buyer purchase or use ON Semiconductor products for any such unintended or unauthorized application, Buyer shall indemnify and hold ON Semiconductor and its officers, employees, subsidiaries, affiliates, and distributors harmless against all claims, costs, damages, and expenses, and reasonable attorney fees arising out of, directly or indirectly, any claim of personal injury or death associated with such unintended or unauthorized use, even if such claim alleges that ON Semiconductor was negligent regarding the design or manufacture of the part. ON Semiconductor is an Equal Opportunity/Affirmative Action Employer. This literature is subject to all applicable copyright laws and is not for resale in any manner.

[www.onsemi.com](http://www.onsemi.com)

[www.onsemi.jp](http://www.onsemi.jp)



# FAN6602R Highly Integrated Green-Mode PWM Controller

## Features

- Low Startup Current: 8  $\mu$ A
- Low Standby Power: Under 0.1 W
- Low Operating Current in Green Mode: 600  $\mu$ A
- PWM Frequency Continuously Decreasing with Cycle Skipping and Burst Mode at Light Loads
- Fixed PWM Frequency (65 kHz) with Frequency Hopping
- Full Range Frequency Hopping
- Peak-Current Mode Operation with Cycle-by-Cycle Current Limiting
- Constant Output Power Limit (Full AC Input Range)
- V<sub>DD</sub> Over-Voltage Protection (OVP)
- Feedback Open-Loop Protection: 60 ms Delay
- Internal OTP Sensor with Hysteresis
- Gate Output Maximum Voltage Clamp: 13.5 V
- Gate Driving Capability: 400 mA
- Soft-Start Time: 6 ms
- Soft Driving for EMI Improvement

## Applications

General-purpose switched-mode power supplies and flyback power converters, including:

- Power Adapters
- Open-Frame SMPS
- SMPS with Surge-Current Output, such as for Printers, Scanners, Motor Drivers

## Description

A highly integrated PWM controller, FAN6602R provides several features to enhance the performance of flyback converters. To minimize standby power consumption, a proprietary Green Mode provides off-time modulation to continuously decrease the switching frequency under light-load conditions. Under zero-load conditions, the power supply enters Burst Mode, which completely shuts off PWM output. Output restarts just before the supply voltage drops below the Under-Voltage Lockout (UVLO) lower limit. Green Mode enables power supplies to meet international power conservation requirements.

The FAN6602R is designed for SMPS and integrates a frequency-hopping function that helps to reduce EMI emission of a power supply with minimum line filters. To compensate the power limit variation over universal input range, a current limit (V<sub>LIMIT</sub>) adaptively keeps the power limit substantially constant. The gate output is clamped at 13.5 V to protect the external MOSFET from over-voltage damage.

Other protection functions include V<sub>DD</sub> Over-Voltage Protection (OVP), and Over-Temperature Protection (OTP). For OTP, an external NTC thermistor can be applied to sense the ambient temperature. Protection types are shown in Table 1.

**Table 1. Protection Type**

Part Number	OVP	OLP	OTP / OTP2
FAN6602R	AR	AR	AR

## Ordering Information

Part Number	Operating Temperature Range	Package	Packing Method
FAN6602RM6X	-40 to +105°C	6-Lead, SOT23, JEDEC MO-178 Variation AB, 1.6 mm Wide	Tape & Reel

### Typical Application

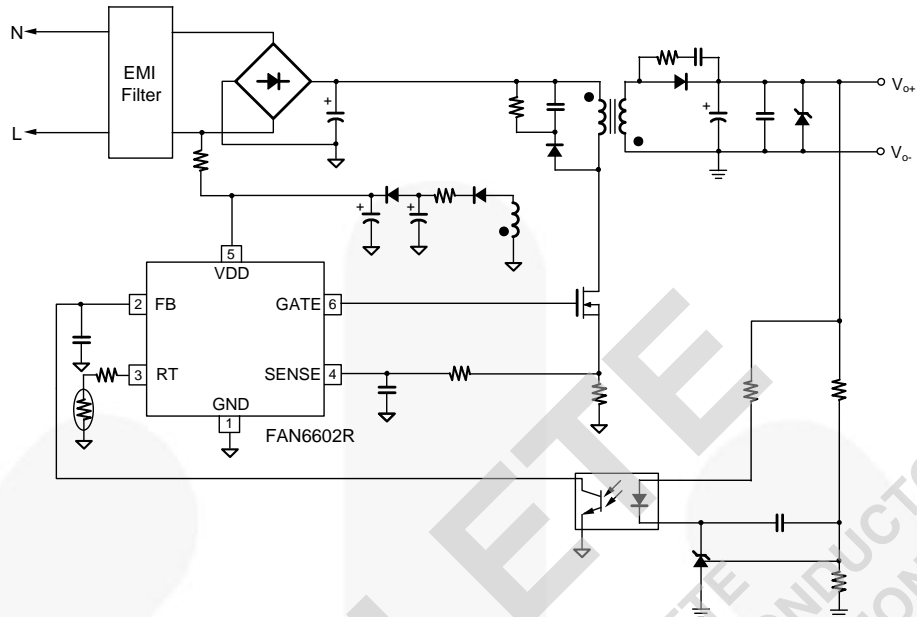

Figure 1. Typical Application

### Block Diagram

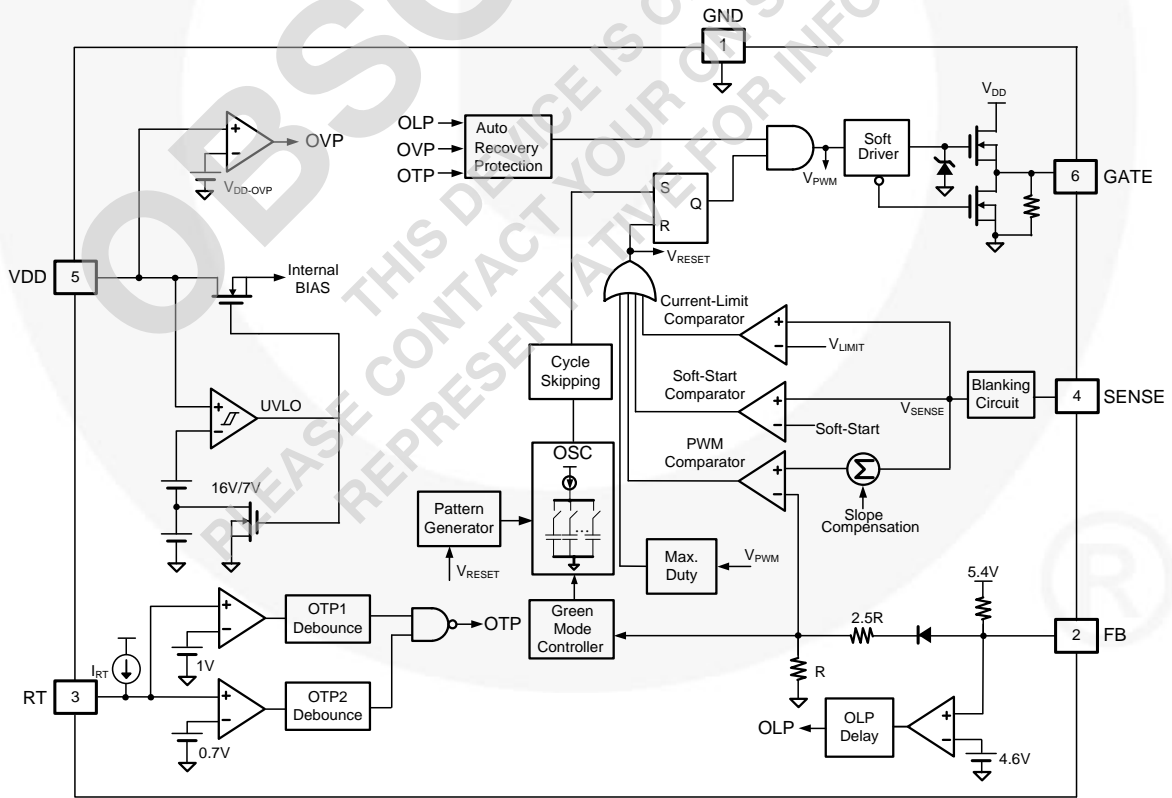

Figure 2. Block Diagram

## Marking Information

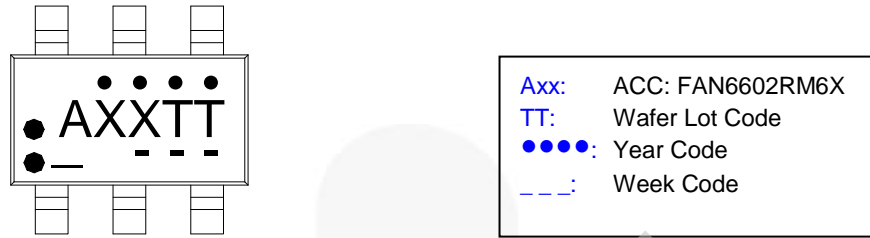

Figure 3. Top Mark

## Pin Configuration

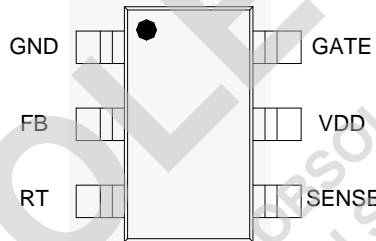

Figure 4. Pin Configuration

## Pin Definitions

Pin #	Name	Function	Description
1	GND	Ground	Ground.
2	FB	Feedback	The FB pin provides the output voltage regulation signal. It provides feedback to the internal PWM comparator, so the PWM comparator can control the duty cycle. This pin also provides over-current protection. If $V_{FB}$ is higher than the trigger level and persists at that level, the controller stops and restarts.
3	RT	Temperature Detection	An external NTC thermistor is connected from this pin to the GND pin. The impedance of the NTC decreases at high temperatures. If the voltage of the RT pin drops below the threshold, PWM output is disabled.
4	SENSE	Current Sense	This pin senses the voltage across a resistor. When the voltage reaches the internal threshold, PWM output is disabled and this activates over-current protection. This pin also provides current amplitude information for Current Mode control.
5	VDD	Power Supply	Power supply.
6	GATE	Driver Output	The totem-pole output driver for driving the power MOSFET.

## Absolute Maximum Ratings

Stresses exceeding the absolute maximum ratings may damage the device. The device may not function or be operable above the recommended operating conditions and stressing the parts to these levels is not recommended. In addition, extended exposure to stresses above the recommended operating conditions may affect device reliability. The absolute maximum ratings are stress ratings only. All voltage values, except differential voltages, are given with respect to GND pin.

Symbol	Parameter	Min.	Max.	Unit
V <sub>DD</sub>	Supply Voltage		30	V
V <sub>L</sub>	Input Voltage to FB, SENSE, and RT Pins	-0.3	7.0	V
P <sub>D</sub>	Power Dissipation at T <sub>A</sub> <50°C		400	mW
R <sub>ΘJA</sub>	Thermal Resistance (Junction-to-Ambient)		244	°C/W
T <sub>J</sub>	Operating Junction Temperature	-40	+150	°C
T <sub>STG</sub>	Storage Temperature Range	-55	+150	°C
T <sub>L</sub>	Lead Temperature, Wave Soldering, 10 Seconds		+260	°C

## ESD Capability

Symbol	Parameter	Value	Unit
ESD	Human Body Model, EIA/JESD22-A114	6.0	kV
	Charge Device Model, JESD22-C101	2.0	kV

## Recommended Operating Conditions

The Recommended Operating Conditions table defines the conditions for actual device operation. Recommended operating conditions are specified to ensure optimal performance to the datasheet specifications. Fairchild does not recommend exceeding them or designing to Absolute Maximum Ratings.

Symbol	Parameter	Min.	Max.	Unit
T <sub>A</sub>	Operating Ambient Temperature	-40	+105	°C
V <sub>DD</sub>	Supply Voltage		25	V
V <sub>L</sub>	Input Voltage to FB, SENSE, and RT Pins	-0.3	6.0	V
T <sub>J</sub>	Operating Junction Temperature	-40	+125	°C

## Electrical Characteristics

$V_{DD} = 7.5 \sim 20 \text{ V}$  and  $T_A = -40 \sim 105^\circ\text{C}$ , unless otherwise noted.

Symbol	Parameter	Condition	Min.	Typ.	Max.	Unit
<b>V<sub>DD</sub> Section</b>						
$V_{DD-OP}$	Continuously Operating Voltage				20	V
$V_{DD-ON}$	Turn-On Threshold Voltage		15	16	17	V
$V_{DD-OFF}$	Turn-Off Threshold Voltage		6.5	7.0	7.5	V
$I_{DD-ST}$	Startup Current	$V_{DD-ON} - 0.16 \text{ V}$		8	15	$\mu\text{A}$
$I_{DD-OP1}$	Operating Supply Current in PWM Operation	$V_{DD} = 20 \text{ V}$ , $V_{FB} = 3 \text{ V}$ , Gate Open			2	mA
$I_{DD-OP2}$	Operating Supply Current when $V_{FB} < V_{FB-ZDC}$	$V_{DD} = 15 \text{ V}$ , $V_{FB} < V_{FB-ZDC}$			600	$\mu\text{A}$
$V_{DD-OVP}$	$V_{DD}$ Over-Voltage Protection	$T_A = 25^\circ\text{C}$	21.0	22.5	24.0	V
$t_{D-VDDOVP}$	$V_{DD}$ OVP Debounce Time			50	70	$\mu\text{s}$
<b>Feedback Input Section</b>						
$A_V$	Input-Voltage to Current-Sense Attenuation		1/4.0	1/3.5	1/3.0	V/V
$Z_{FB}$	Input Impedance	$T_A = 25^\circ\text{C}$		17		k $\Omega$
$V_{FB-OPEN}$	FB Pin Open Voltage		5.2	5.4	5.6	V
$V_{FB-OLP}$	Threshold Voltage for Open-Loop Protection	$T_A = 25^\circ\text{C}$	4.3	4.6	5.0	V
$t_{D-OLP}$	Open-Loop Protection Delay	$V_{FB} > V_{FB-OLP}$ , $t_{ON} > 2.5 \mu\text{s}$ ,	54	60	66	ms
$t_{D-SCP}$	Secondary Short-Circuit Protection Delay	$V_{FB} > V_{FB-OLP}$ , $t_{ON} < 2.5 \mu\text{s}$ ,	6	7	8	ms
$t_{ON-SCP}$	Short-Circuit Protection On-Time Detection	$V_{FB} > V_{FB-OLP}$ ,		2.9		$\mu\text{s}$
<b>Current Sense Section</b>						
$t_{PD}$	Delay to Output			100	250	ns
$t_{LEB}$	Leading-Edge Blanking Time		180	245	310	ns
$V_{STHFL}$	Flat Threshold Voltage for Current Limit	Duty > 55%	0.57	0.60	0.63	V
$V_{STHVA}$	Valley Threshold Voltage for Current Limit	Duty = 0%	0.36	0.39	0.42	V
$t_{SOFT-START}$	Period During Startup Time	Startup Time	4.00	6.00	9.00	ms

Continued on the following page...

### Electrical Characteristics (Continued)

$V_{DD} = 7.5 \sim 20 \text{ V}$  and  $T_A = -40 \sim 105^\circ\text{C}$ , unless otherwise noted.

Symbol	Parameter	Condition	Min.	Typ.	Max.	Unit	
<b>Oscillator Section</b>							
$f_{OSC}$	Normal PWM Frequency	Center Frequency	$V_{FB} > V_{FB-N}$ $T_A = 25^\circ\text{C}$	60	65	68	kHz
		Hopping Range	$V_{FB} \geq V_{FB-N}$ $T_A = 25^\circ\text{C}$		$\pm 4.2$		
	$V_{FB} = V_{FB-G}^{(1)}$ $T_A = 25^\circ\text{C}$			$\pm 2.9$			
$t_{hop-1}$	Hopping Period 1 <sup>(1)</sup>	$V_{FB} \geq V_{FB-N}$		4.4		ms	
$f_{OSC-G}$	Green Mode Minimum Frequency		18	22	26	kHz	
$V_{FB-N}$	FB Threshold Voltage for Frequency Reduction	$T_A = 25^\circ\text{C}$	2.35	2.50	2.65	V	
$V_{FB-G}$	FB Voltage at $f_{OSC-G}$	$T_A = 25^\circ\text{C}$	2.05	2.20	2.30	V	
$V_{FB-SKIP}$	FB Threshold Voltage for Cycle Skipping Period Divide <sup>(1)</sup>	$(V_{FB-N} + V_{FB-G}) / 2$		2.35		V	
$t_{SKIP-N}$	Cycle Skipping Period <sup>(1)</sup>	$V_{FB-SKIP} < V_{FB} < V_{FB-N}$		256		ms	
$t_{SKIP-G}$	Cycle Skipping Period <sup>(1)</sup>	$V_{FB-G} < V_{FB} < V_{FB-SKIP}$		128		ms	
$V_{FB-ZDC}$	FB Threshold Voltage for Zero-Duty		1.4	1.6	1.8	V	
$V_{FB-ZDCR} - V_{FB-ZDC}$	ZDC Hysteresis			0.15		V	
$f_{DV}$	Frequency Variation vs. $V_{DD}$ Deviation	$V_{DD} = 7.5 \text{ V to } 21 \text{ V}$		0.5	2.0	%	
$f_{DT}$	Frequency Variation vs. Temperature Deviation <sup>(1)</sup>				5.0	%	

Continued on following page...

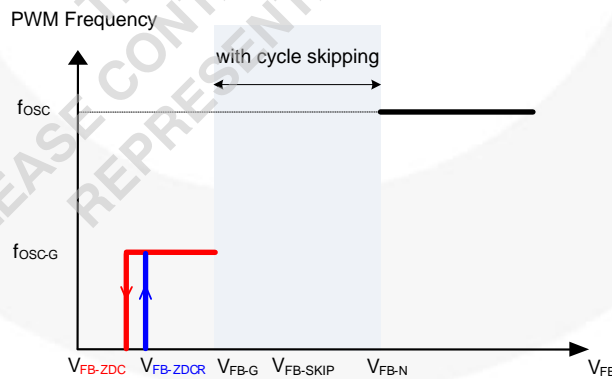

Figure 5. PWM Frequency

**Electrical Characteristics** (Continued)

$V_{DD} = 7.5 \sim 20 \text{ V}$  and  $T_A = -40 \sim 105^\circ\text{C}$ , unless otherwise noted.

Symbol	Parameter	Condition	Min.	Typ.	Max.	Unit
<b>PWM Output Section</b>						
$DCY_{MAX}$	Maximum Duty Cycle		68	75	85	%
$V_{OL}$	Output Voltage Low	$V_{DD} = 15 \text{ V}, I_O = 50 \text{ mA}$			1.5	V
$V_{OH}$	Output Voltage High	$V_{DD} = 8 \text{ V}, I_O = 50 \text{ mA}$	6			V
$t_R$	Rising Time (with Soft Driving)	Gate = 1 nF		150	200	ns
$t_F$	Falling Time	Gate = 1 nF		35	80	ns
$V_{CLAMP}$	Gate Output Clamping Voltage	$V_{DD} = 20 \text{ V}$	12.0	13.5	15.0	V
$I_{O-SOURCE}$	Gate Source Driving Capability <sup>(1)</sup>	$V_{DD} = 15 \text{ V}$		400		mA
$I_{O-SINK}$	Gate Sink Driving Capability <sup>(1)</sup>	$V_{DD} = 15 \text{ V}$		400		mA
<b>Over-Temperature Protection (OTP) Section</b>						
$R_{RT}$	Maximum External Resistance of RT Pin to Trigger Protection	$T_A = 25^\circ\text{C}$	9	10	11	k $\Omega$
$V_{OTP}$	Threshold Voltage for Over-Temperature Protection		0.94	1.03	1.09	V
$I_{RT}$	Output Current of RT Pin	$T_A = 25^\circ\text{C}$	92	100	108	$\mu\text{A}$
$t_{DOTP}$	Over-Temperature Debounce Time	$V_{FB} = V_{FB-N}$	13.5	17.0	20.5	ms
$V_{OTP2}$	Second Threshold Voltage for Over-Temperature Protection		0.65	0.72	0.78	V
$t_{DOTP2}$	Second Over-Temperature Debounce Time		50	125	200	$\mu\text{s}$
$T_{OTP}$	Protection Junction Temperature <sup>(1,2)</sup>			+135		$^\circ\text{C}$
$T_{Restart}$	Restart Junction Temperature <sup>(1,3)</sup>			$T_{OTP} - 25$		$^\circ\text{C}$

**Notes:**

1. Guarantee by design.
2. When activated, the output is disabled.
3. The threshold temperature for enabling the output again and resetting the after OTP has been activated.



## Typical Performance Characteristics

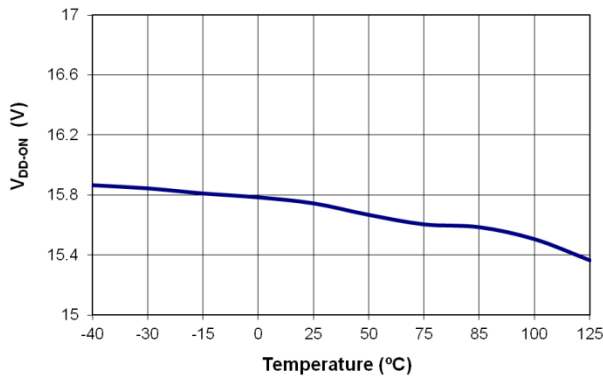

Figure 6. Turn-On Threshold Voltage (V<sub>DD-ON</sub>) vs. Temperature

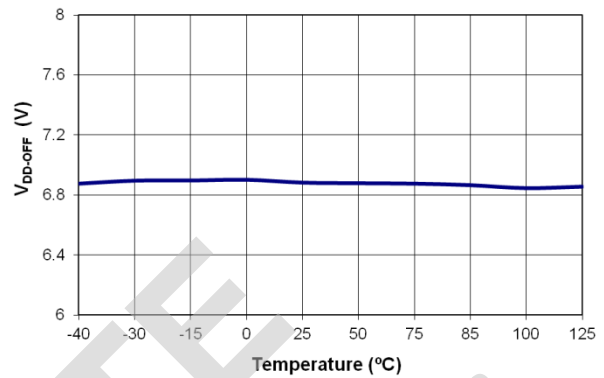

Figure 7. Turn-Off Threshold Voltage (V<sub>DD-OFF</sub>) vs. Temperature

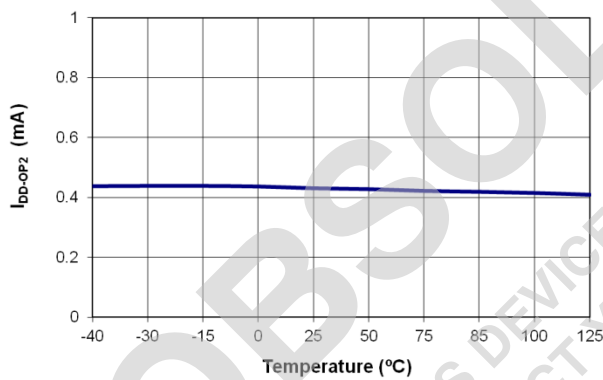

Figure 8. Operating Current (I<sub>DD-OP2</sub>) vs. Temperature

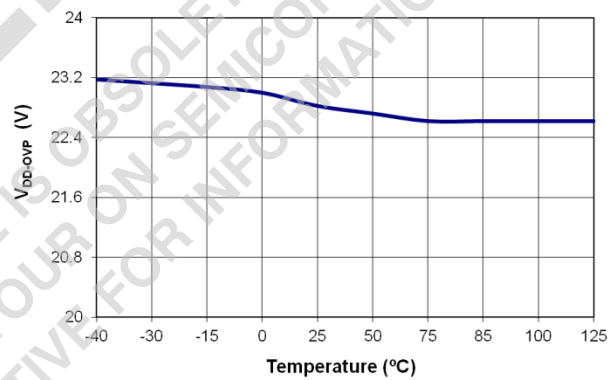

Figure 9. V<sub>DD</sub> Over-Voltage Protection (V<sub>DD-OVP</sub>) vs. Temperature

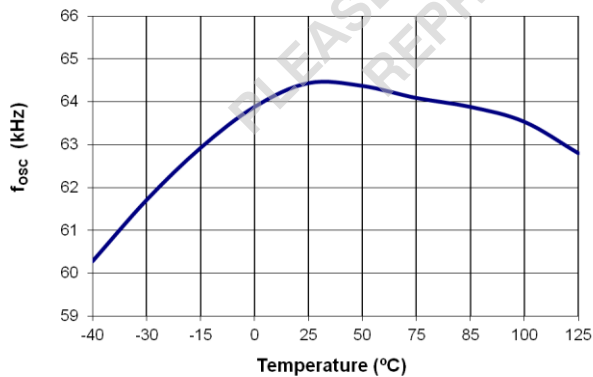

Figure 10. Center Frequency (f<sub>osc</sub>) vs. Temperature

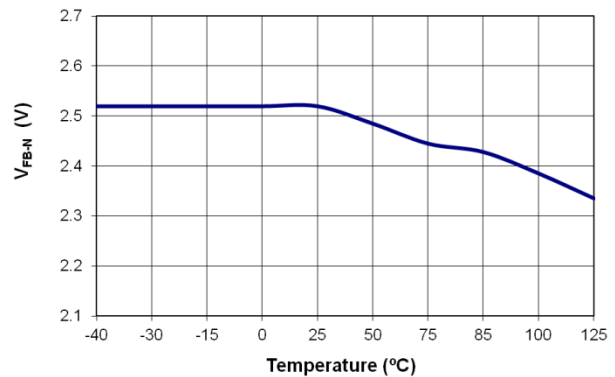

Figure 11. FB Threshold Voltage for Frequency Reduction (V<sub>FB-N</sub>) vs. Temperature

Typical Performance Characteristics (Continued)

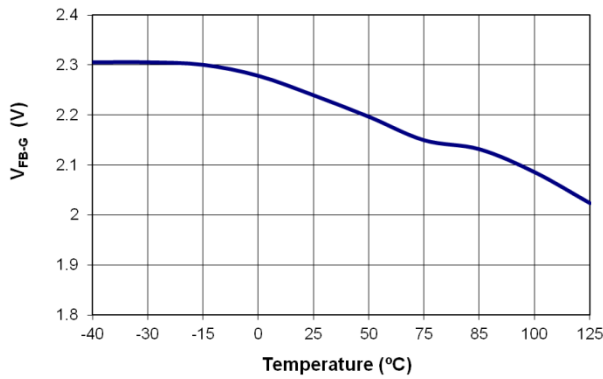

Figure 12. FB Voltage at  $f_{OSC-G}$  ( $V_{FB-G}$ ) vs. Temperature

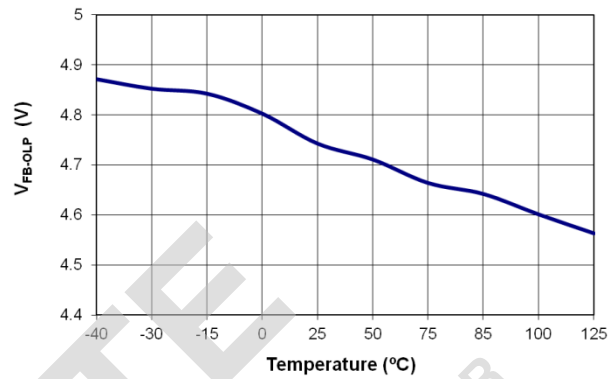

Figure 13. Threshold Voltage for Open-Loop Protection ( $V_{FB-OLP}$ ) vs. Temperature

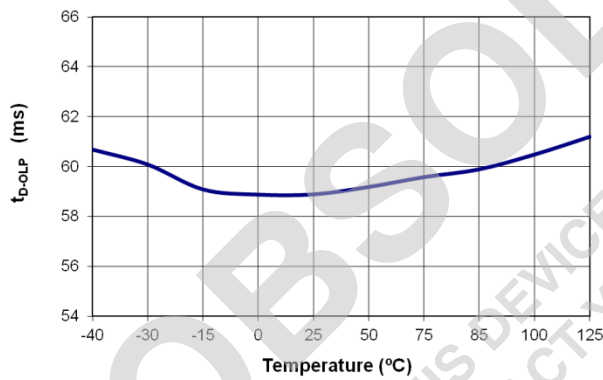

Figure 14. Open-Loop Protection Delay ( $t_{D-OLP}$ ) vs. Temperature

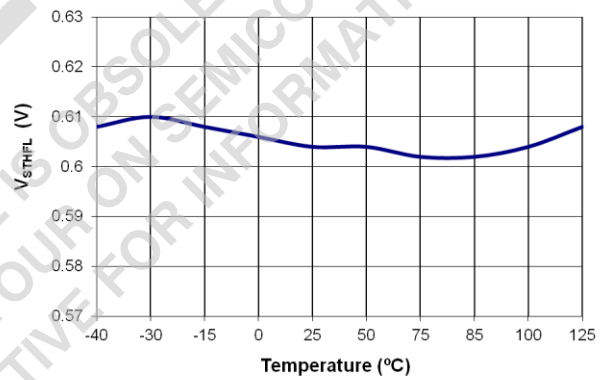

Figure 15. Flat Threshold Voltage for Current Limit ( $V_{STHFL}$ ) vs. Temperature

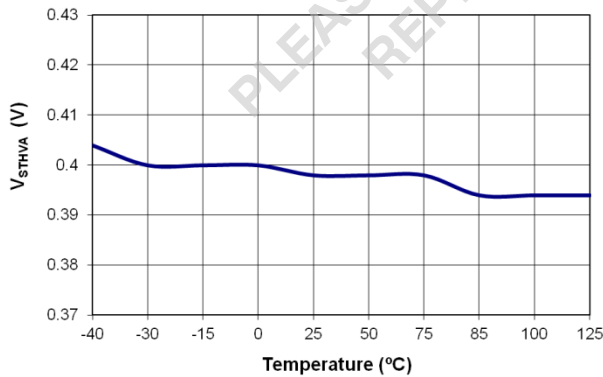

Figure 16. Valley Threshold Voltage for Current Limit ( $V_{STHVA}$ ) vs. Temperature

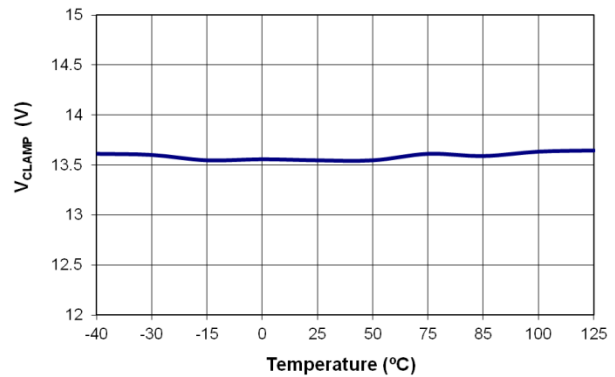

Figure 17. Gate Output Clamping Voltage ( $V_{CLAMP}$ ) vs. Temperature

Typical Performance Characteristics (Continued)

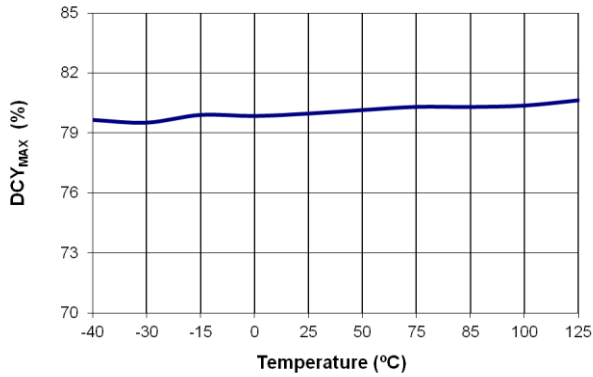

Figure 18. Maximum Duty Cycle (DCY<sub>MAX</sub>) vs. Temperature

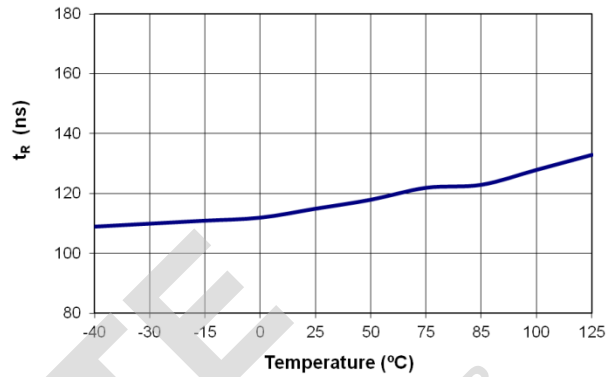

Figure 19. Rising Time (t<sub>R</sub>) vs. Temperature

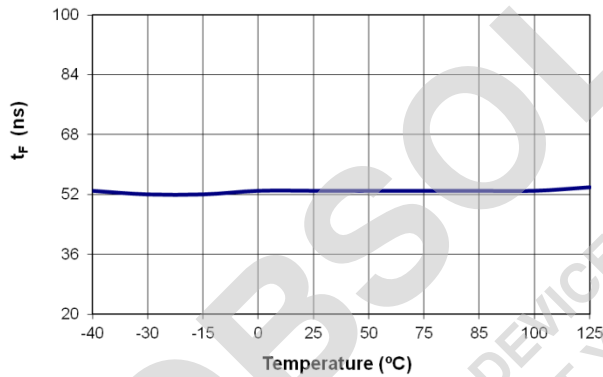

Figure 20. Falling Time (t<sub>F</sub>) vs. Temperature

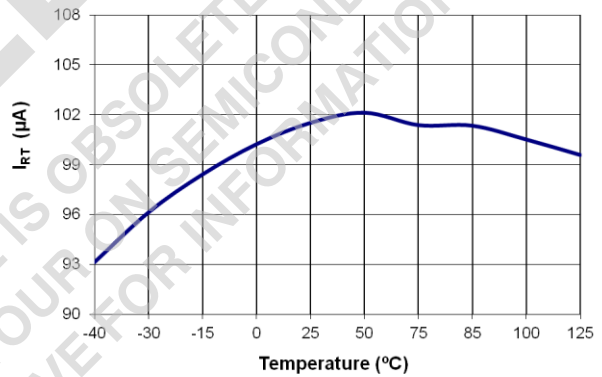

Figure 21. Output Current of RT Pin (I<sub>RT</sub>) vs. Temperature

## Operation Description

### Startup Operation

Figure 22 shows a typical startup circuit and transformer auxiliary winding for a typical application. Before switching operation begins, FAN6602R consumes only startup current (typically 8  $\mu$ A) and the current supplied through the startup resistor charges the  $V_{DD}$  capacitor ( $C_{DD}$ ). When  $V_{DD}$  reaches turn-on voltage of 16 V ( $V_{DD-ON}$ ), switching begins and the current consumed increases to 2 mA. The hold-up capacitor continues to supply  $V_{DD}$  before the energy can be delivered from the auxiliary winding of the main transformer. The large hysteresis of  $V_{DD}$  (7 V) provides more holdup time, which allows using a small capacitor for  $V_{DD}$ . The startup resistor is typically connected to AC line.

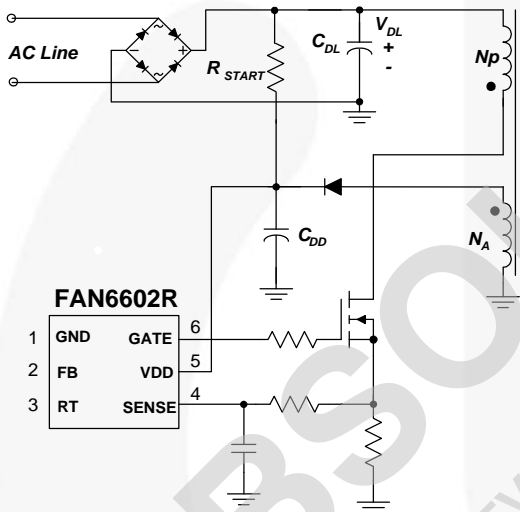

Figure 22. Startup Circuit

### Green-Mode Operation

The FAN6602R uses feedback voltage ( $V_{FB}$ ) as an indicator of the output load and modulates the PWM frequency, as shown in Figure 23, such that the switching frequency decreases as load decreases. In heavy-load conditions, the switching frequency is 65 kHz. Once  $V_{FB}$  decreases below  $V_{FB-N}$  (2.5 V), the PWM frequency starts to linearly decrease with cycle skipping from 65 kHz to 22 kHz to reduce the switching losses. As  $V_{FB}$  decreases below  $V_{FB-G}$  (2.2 V), the switching frequency is fixed at 22 kHz and FAN6602R enters “deep” Green Mode, where the operating current decreases to 600  $\mu$ A (typical), further reducing the standby power consumption. As  $V_{FB}$  decreases below  $V_{FB-ZDC}$  (1.6 V), FAN6602R enters Burst-Mode operation. When  $V_{FB}$  drops below  $V_{FB-ZDC}$ , switching stops and the output voltage starts to drop, which causes the feedback voltage to rise. Once  $V_{FB}$  rises above  $V_{FB-ZDC}$ , switching resumes. Burst Mode alternately enables and disables switching, thereby reducing switching loss in Standby Mode.

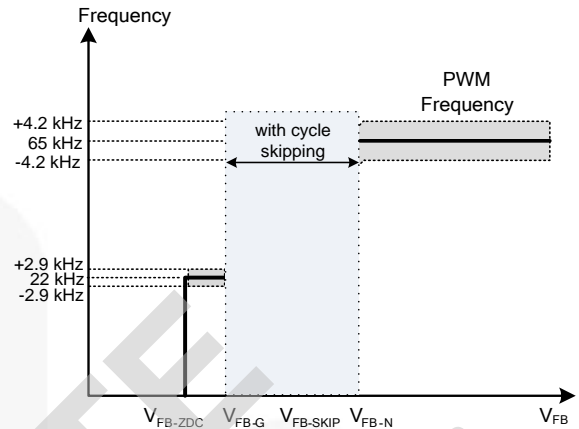

Figure 23. PWM Frequency

### Frequency Hopping

EMI reduction is accomplished by frequency hopping, which spreads the energy over a wider frequency range than the bandwidth measured by the Electromagnetic Interference (EMI) test equipment. An internal frequency-hopping circuit changes the switching frequency between 60.8 kHz and 69.2 kHz with a period of 4.4 ms.

### Leading-Edge Blanking (LEB)

Each time the power MOSFET is switched on, a turn-on spike occurs on the sense resistor. To avoid premature termination of the switching pulse, a leading-edge blanking time ( $t_{LEB}$ ) is built in. During this blanking period, the current-limit comparator is disabled and cannot switch off the gate driver.

### Gate Output / Soft Driving

The BiCMOS output stage is a fast totem-pole gate driver. Cross conduction has been avoided to minimize heat dissipation, increase efficiency, and enhance reliability. The output driver is clamped by an internal 13.5 V Zener diode to protect power MOSFET transistors against undesirable gate over voltage. A soft-driving circuit is implemented to minimize EMI.

### Soft-Start

For many applications, it is necessary to minimize the inrush current at startup. The built-in 6 ms soft-start circuit significantly reduces the startup current spike and output voltage overshoot.

### Slope Compensation

The sensed voltage across the current-sense resistor is used for peak-current-mode control and pulse-by-pulse current limiting. Built-in slope compensation improves stability and prevents sub-harmonic oscillation. FAN6602R inserts a synchronized positive-going ramp at every switching cycle as slope compensation.

## Protections

Self-protective functions include  $V_{DD}$  Over-Voltage Protection (OVP), Open-Loop / Overload Protection (OLP), Over-Current Protection (OCP), Short-Circuit Protection (SCP) and Over-Temperature Protection (OTP). All the self-protective functions are Auto-Restart (AR) Mode protections

### Auto-Restart (AR) Mode Protection

Once a fault condition is detected, switching is terminated and the MOSFET remains off. This causes  $V_{DD}$  to fall because no more power is delivered from auxiliary winding. When  $V_{DD}$  falls to  $V_{DD-OFF}$  (7 V), the protection is reset and the operating current reduces to startup current, which causes  $V_{DD}$  to rise. FAN6602R resumes normal operation when  $V_{DD}$  reaches  $V_{DD-ON}$  (16 V). In this manner, the auto-restart can alternately enable and disable the switching of the MOSFET until the fault condition is eliminated.

### Over-Current Protection (OCP)

FAN6602R over-current protection is a pulse-by-pulse bias current limit threshold ( $V_{STHVA}$  and  $V_{STHFL}$ ) that turns off the MOSFET once the sensing voltage of MOSFET drain current reaches the threshold. The current limit compensates the power-limit variation over the universal input range and adaptively keeps the power limit substantially constant.

### Open-Loop / Overload Protection (OLP)

When the upper branch of the voltage divider for the shunt regulator is broken, no current flows through the

photo-coupler transistor, which pulls up the feedback voltage to 5.4 V.

When feedback voltage is above 4.6 V for longer than 60 ms, OLP is triggered. This protection is also triggered when the SMPS output drops below the nominal value for longer than 60 ms due to the overload condition.

If the secondary output-short situation occurs when the feedback voltage is above 4.6 V, protection time is 7 ms for shorter debounce time.

### $V_{DD}$ Over-Voltage Protection (OVP)

$V_{DD}$  over-voltage protection prevents IC damage caused by over-voltage on the  $V_{DD}$  pin. Once the  $V_{DD}$  voltage is over the over-voltage protection voltage ( $V_{DD-OVP}$ ), and lasts for  $t_{D-VDDOVP}$ , the PWM pulses are disabled. A debounce time (typically 50  $\mu$ s) prevents false triggering by switching noise.

### Over-Temperature Protection (OTP)

The OTP circuit is composed of current source and voltage comparators. Typically, an NTC thermistor is connected between the RT and GND pins. If the voltage of this pin drops below a threshold of 1.03 V, PWM output is disabled after  $t_{DOTP}$  debounce time. If this pin voltage drops below 0.72 V, it triggers the protection immediately after  $t_{DOTP2}$  debounce time.



## Transformer Specification

- Core: RM 8
- Bobbin: RM 8

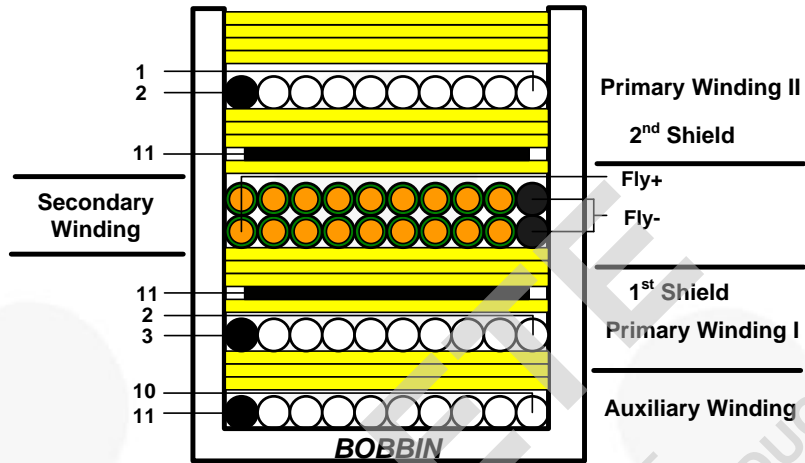

Figure 25. Transformer

NO	Terminal		Wire	Ts	Insulation
	S	F			Ts
N1	11	10	0.25 • 1	9	3
N2	3	2	0.25 • 1	33	1
	11		COPPER SHIELD	1.2	3.0
N3	Fly-	Fly+	0.5 • 2	12	1
	11		COPPER SHIELD	1.2	3.0
N4	2	1	0.25 • 1	33	4
			CORE ROUNDING TAPE		3

	Pin	Specification	Remark
Primary-Side Inductance	3–1	920 $\mu$ H $\pm$ 5%	100 kHz, 1 V
Primary-Side Effective Leakage	3–1	15 $\mu$ H Maximum	Short One of the Secondary Windings

Physical Dimensions

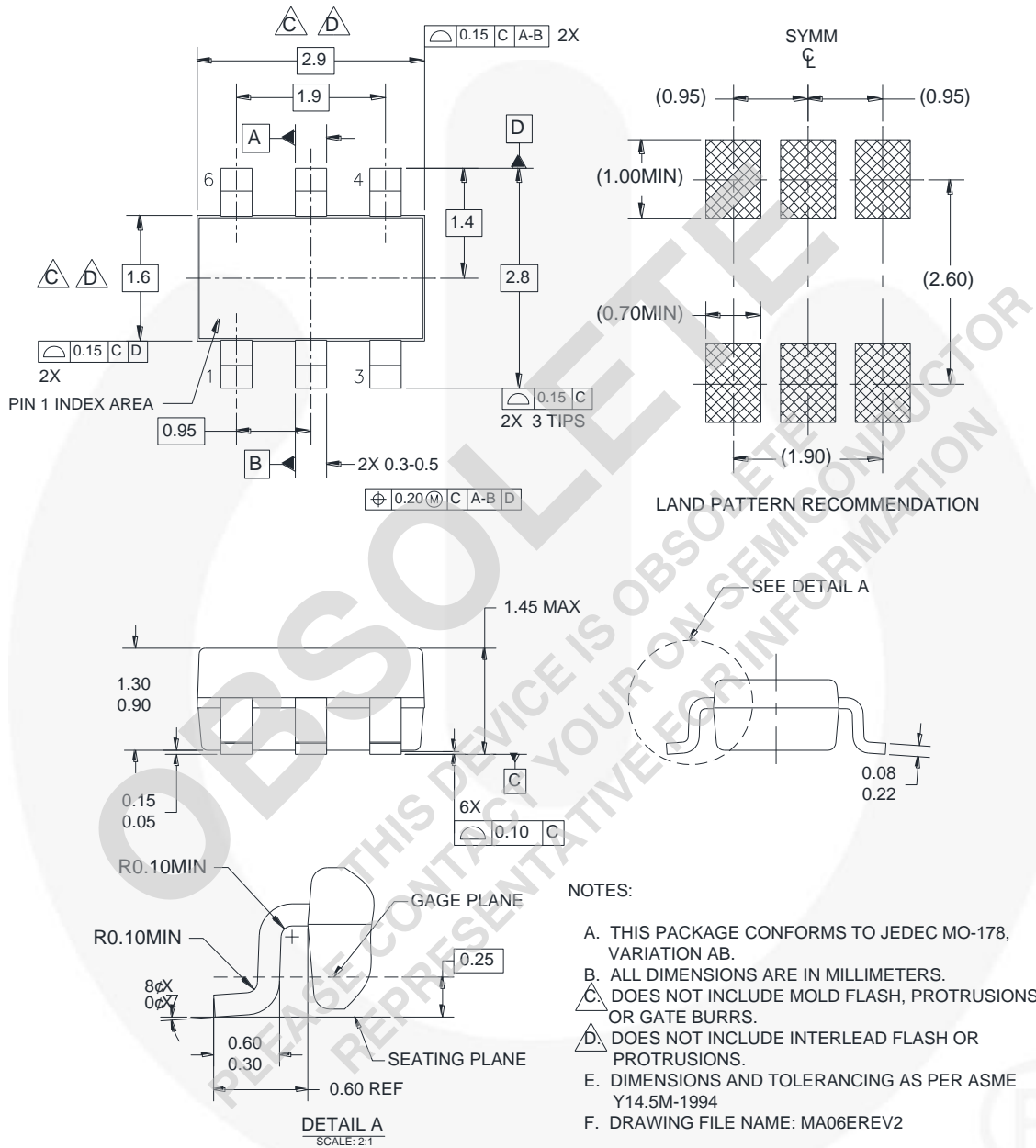

Figure 26. 6-Lead, SOT23, JEDEC MO-178 Variation AB, 1.6 mm Wide





**TRADEMARKS**

The following includes registered and unregistered trademarks and service marks, owned by Fairchild Semiconductor and/or its global subsidiaries, and is not intended to be an exhaustive list of all such trademarks.

- |                          |  |                                       |                  |
|--------------------------|--|---------------------------------------|------------------|
| AccuPower™               | F-PFS™   | OPTOPLANAR®                           | SYSTEM GENERAL®  |
| AttitudeEngine™          | FRFET®   |                                       | TinyBoost®       |
| Awinda®                  | Global Power Resource™                         |                                       | TinyBuck®        |
| AX-CAP®*                 | GreenBridge™                                   |                                       | TinyCalc™        |
| BitSiC™                  | Green FPS™                                     | PowerTrench®                          | TinyLogic®       |
| Build it Now™            | Green FPS™ e-Series™                           | PowerXS™                              | TINYOPTO™        |
| CorePLUS™                | Gmax™  | Programmable Active Droop™            | TinyPower™       |
| CorePOWER™               | GTO™   | QFET®                                 | TinyPWM™         |
| CROSSVOLT™               | IntelliMAX™                                    | QS™                                   | TinyWire™        |
| CTL™                     | ISOPLANAR™                                     | Quiet Series™                         | TranSiC™         |
| Current Transfer Logic™  | ISOPLANAR™                                     | RapidConfigure™                       | TriFault Detect™ |
| DEUXPEED®                | Making Small Speakers Sound Louder and Better™ | ™                                     | TRUECURRENT®*    |
| Dual Cool™               | MegaBuck™                                      | Saving our world, 1mW/W/kW at a time™ | µSerDes™         |
| EcoSPARK®                | MICROCOUPLER™                                  | SignalWise™                           | SerDes™          |
| EfficientMax™            | MicroFET™                                      | SmartMax™                             | UHC®             |
| ESBC™                    | MicroPak™                                      | SMART START™                          | Ultra FRFET™     |
| Fairchild®               | MicroPak2™                                     | Solutions for Your Success™           | UnifET™          |
| Fairchild Semiconductor® | MillerDrive™                                   | SPM®                                  | VCX™             |
| FACT Quiet Series™       | MotionMax™                                     | STEALTH™                              | VisualMax™       |
| FACT®                    | MotionGrid®                                    | SuperFET®                             | VoltagePlus™     |
| FAST®                    | MTI®   | SuperSOT™-3                           | XSTM             |
| FASTV™                   | MTX®   | SuperSOT™-6                           | Xsens™           |
| FastvCore™               | MVN®   | SuperSOT™-8                           | 仙童™              |
| FETBench™                | mWSaver®                                       | SupreMOS®                             |                  |
| FPS™                     | OptoHit™                                       | SyncFET™                              |                  |
|                          | OPTOLOGIC®                                     | Sync-Lock™                            |                  |

\* Trademarks of System General Corporation, used under license by Fairchild Semiconductor.

**DISCLAIMER**

FAIRCHILD SEMICONDUCTOR RESERVES THE RIGHT TO MAKE CHANGES WITHOUT FURTHER NOTICE TO ANY PRODUCTS HEREIN TO IMPROVE RELIABILITY, FUNCTION, OR DESIGN. TO OBTAIN THE LATEST, MOST UP-TO-DATE DATASHEET AND PRODUCT INFORMATION, VISIT OUR WEBSITE AT [HTTP://WWW.FAIRCHILDSEMI.COM](http://www.fairchildsemi.com). FAIRCHILD DOES NOT ASSUME ANY LIABILITY ARISING OUT OF THE APPLICATION OR USE OF ANY PRODUCT OR CIRCUIT DESCRIBED HEREIN; NEITHER DOES IT CONVEY ANY LICENSE UNDER ITS PATENT RIGHTS, NOR THE RIGHTS OF OTHERS. THESE SPECIFICATIONS DO NOT EXPAND THE TERMS OF FAIRCHILD'S WORLDWIDE TERMS AND CONDITIONS, SPECIFICALLY THE WARRANTY THEREIN, WHICH COVERS THESE PRODUCTS.

**LIFE SUPPORT POLICY**

FAIRCHILD'S PRODUCTS ARE NOT AUTHORIZED FOR USE AS CRITICAL COMPONENTS IN LIFE SUPPORT DEVICES OR SYSTEMS WITHOUT THE EXPRESS WRITTEN APPROVAL OF FAIRCHILD SEMICONDUCTOR CORPORATION.

As used herein:

1. Life support devices or systems are devices or systems which, (a) are intended for surgical implant into the body or (b) support or sustain life, and (c) whose failure to perform when properly used in accordance with instructions for use provided in the labeling, can be reasonably expected to result in a significant injury of the user.
2. A critical component in any component of a life support, device, or system whose failure to perform can be reasonably expected to cause the failure of the life support device or system, or to affect its safety or effectiveness.

**ANTI-COUNTERFEITING POLICY**

Fairchild Semiconductor Corporation's Anti-Counterfeiting Policy. Fairchild's Anti-Counterfeiting Policy is also stated on our external website, [www.fairchildsemi.com](http://www.fairchildsemi.com), under Sales Support.

Counterfeiting of semiconductor parts is a growing problem in the industry. All manufacturers of semiconductor products are experiencing counterfeiting of their parts. Customers who inadvertently purchase counterfeit parts experience many problems such as loss of brand reputation, substandard performance, failed applications, and increased cost of production and manufacturing delays. Fairchild is taking strong measures to protect ourselves and our customers from the proliferation of counterfeit parts. Fairchild strongly encourages customers to purchase Fairchild parts either directly from Fairchild or from Authorized Fairchild Distributors who are listed by country on our web page cited above. Products customers buy either from Fairchild directly or from Authorized Fairchild Distributors are genuine parts, have full traceability, meet Fairchild's quality standards for handling and storage and provide access to Fairchild's full range of up-to-date technical and product information. Fairchild and our Authorized Distributors will stand behind all warranties and will appropriately address any warranty issues that may arise. Fairchild will not provide any warranty coverage or other assistance for parts bought from Unauthorized Sources. Fairchild is committed to combat this global problem and encourage our customers to do their part in stopping this practice by buying direct or from authorized distributors.

**PRODUCT STATUS DEFINITIONS**

**Definition of Terms**

Datasheet Identification	Product Status	Definition
Advance Information	Formative / In Design	Datasheet contains the design specifications for product development. Specifications may change in any manner without notice.
Preliminary	First Production	Datasheet contains preliminary data; supplementary data will be published at a later date. Fairchild Semiconductor reserves the right to make changes at any time without notice to improve design.
No Identification Needed	Full Production	Datasheet contains final specifications. Fairchild Semiconductor reserves the right to make changes at any time without notice to improve the design.
Obsolete	Not In Production	Datasheet contains specifications on a product that is discontinued by Fairchild Semiconductor. The datasheet is for reference information only.

Rev. I73

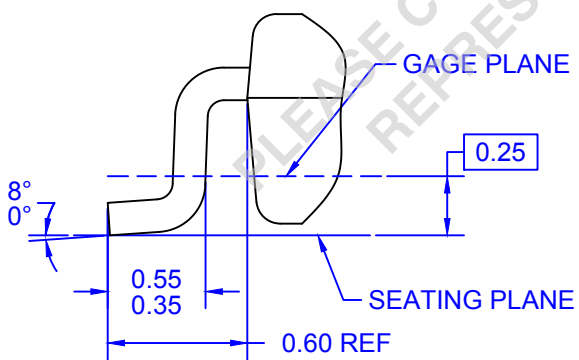
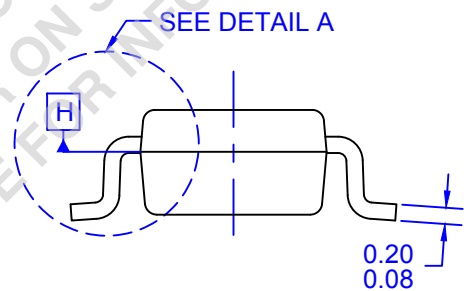
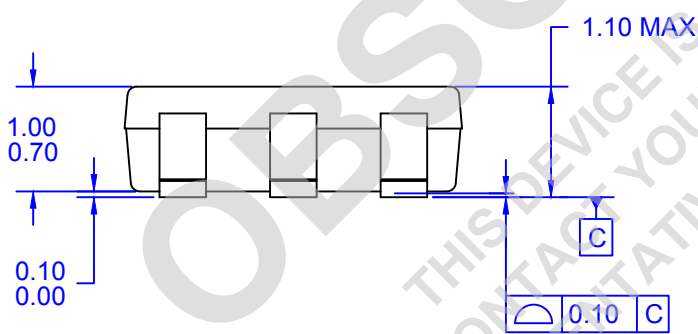
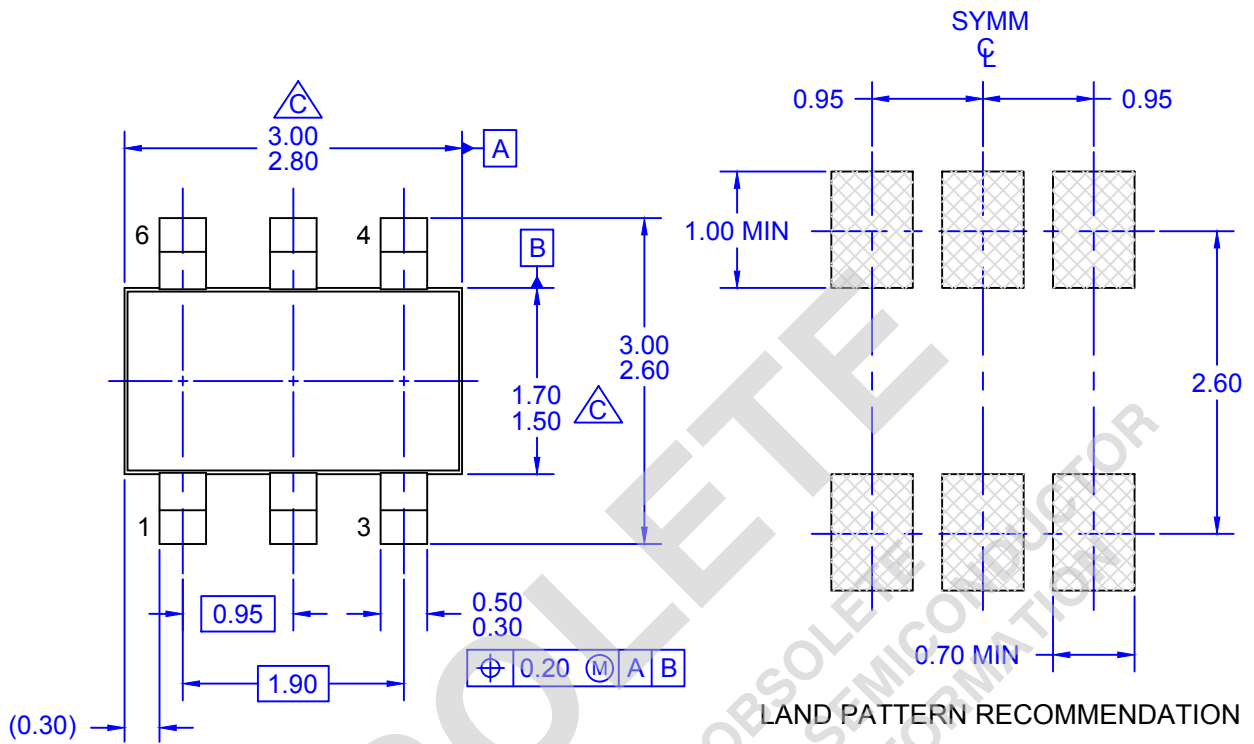

DETAIL A  
SCALE: 50X

NOTES: UNLESS OTHERWISE SPECIFIED  
 A) THIS PACKAGE CONFORMS TO JEDEC MO-193. VAR. AA, ISSUE E.  
 B) ALL DIMENSIONS ARE IN MILLIMETERS.  
 C) PACKAGE LENGTH DOES NOT INCLUDE MOLD FLASH, PROTRUSIONS OR GATE BURRS. MOLD FLASH, PROTRUSIONS OR GATE BURRS SHALL NOT EXCEED 0.25mm PER END. PACKAGE WIDTH DOES NOT INCLUDE INTERLEAD FLASH OR PROTRUSION. INTERLEAD FLASH OR PROTRUSION SHALL NOT EXCEED 0.25mm PER SIDE. PACKAGE LENGTH AND WIDTH DIMENSIONS ARE DETERMINED AT DATUM H.  
 D) DRAWING FILE NAME: MKT-MA06AREVF

ON Semiconductor



**OBSOLETE**  
THIS DEVICE IS OBSOLETE  
PLEASE CONTACT YOUR ON SEMICONDUCTOR  
REPRESENTATIVE FOR INFORMATION

ON Semiconductor and  are trademarks of Semiconductor Components Industries, LLC dba ON Semiconductor or its subsidiaries in the United States and/or other countries. ON Semiconductor owns the rights to a number of patents, trademarks, copyrights, trade secrets, and other intellectual property. A listing of ON Semiconductor's product/patent coverage may be accessed at [www.onsemi.com/site/pdf/Patent-Marking.pdf](http://www.onsemi.com/site/pdf/Patent-Marking.pdf). ON Semiconductor reserves the right to make changes without further notice to any products herein. ON Semiconductor makes no warranty, representation or guarantee regarding the suitability of its products for any particular purpose, nor does ON Semiconductor assume any liability arising out of the application or use of any product or circuit, and specifically disclaims any and all liability, including without limitation special, consequential or incidental damages. Buyer is responsible for its products and applications using ON Semiconductor products, including compliance with all laws, regulations and safety requirements or standards, regardless of any support or applications information provided by ON Semiconductor. "Typical" parameters which may be provided in ON Semiconductor data sheets and/or specifications can and do vary in different applications and actual performance may vary over time. All operating parameters, including "Typicals" must be validated for each customer application by customer's technical experts. ON Semiconductor does not convey any license under its patent rights nor the rights of others. ON Semiconductor products are not designed, intended, or authorized for use as a critical component in life support systems or any FDA Class 3 medical devices or medical devices with a same or similar classification in a foreign jurisdiction or any devices intended for implantation in the human body. Should Buyer purchase or use ON Semiconductor products for any such unintended or unauthorized application, Buyer shall indemnify and hold ON Semiconductor and its officers, employees, subsidiaries, affiliates, and distributors harmless against all claims, costs, damages, and expenses, and reasonable attorney fees arising out of, directly or indirectly, any claim of personal injury or death associated with such unintended or unauthorized use, even if such claim alleges that ON Semiconductor was negligent regarding the design or manufacture of the part. ON Semiconductor is an Equal Opportunity/Affirmative Action Employer. This literature is subject to all applicable copyright laws and is not for resale in any manner.

## PUBLICATION ORDERING INFORMATION

### LITERATURE FULFILLMENT:

Literature Distribution Center for ON Semiconductor  
19521 E. 32nd Pkwy, Aurora, Colorado 80011 USA  
**Phone:** 303-675-2175 or 800-344-3860 Toll Free USA/Canada  
**Fax:** 303-675-2176 or 800-344-3867 Toll Free USA/Canada  
**Email:** [orderlit@onsemi.com](mailto:orderlit@onsemi.com)

**N. American Technical Support:** 800-282-9855 Toll Free  
USA/Canada  
**Europe, Middle East and Africa Technical Support:**  
Phone: 421 33 790 2910  
**Japan Customer Focus Center**  
Phone: 81-3-5817-1050

**ON Semiconductor Website:** [www.onsemi.com](http://www.onsemi.com)  
**Order Literature:** <http://www.onsemi.com/orderlit>  
For additional information, please contact your local  
Sales Representative