

# FAN4146

## Ground Fault Interrupter

### Description

The FAN4146 is a low-power controller for AC outlet Appliance Leakage Circuit Interrupters (ALCI) and two-wire Residual Current Devices (RCD). The FAN4146 detects hazardous grounding conditions and open circuits the line before a harmful shock occurs.

Internally, the FAN4146 contains a diode rectifier, precision bandgap 12 V shunt regulator, precision low  $V_{OS}$  offset-sense amplifier, time delay noise filter, window-detection comparators, and a SCR driver. With the addition of a minimum number of external components, the FAN4146 detects and protects against a hot-wire-to-ground fault. The minimum number of components and the small SUPERSOT™ package allow for a small-form-factor, low-cost application solution.

The FAN4146 circuitry has a built-in rectifier and shunt regulator that operates with a low quiescent current. This allows for a high-value, low-wattage-series supply resistor. The internal temperature compensated shunt regulator, sense amplifier, and bias circuitry provide for precision ground-fault detection. The low  $V_{OS}$  offset-sense amplifier allows direct coupling of the sense coil to the amplifier's feedback signal. This eliminates the large 50/60 Hz AC-coupling capacitor. The internal delay filter rejects high-frequency noise spikes common with inductive loads. This decreases false nuisance tripping. The internal SCR driver is temperature compensated and designed to satisfy the current requirements for a wide selection of external SCRs.

The minimum number of external components and the 6-pin SUPERSOT package enable for a low-cost, compact design and layout. The FAN4146ESX is an enhanced temperature range device.

### Features

- For Two-wire ALCI and RCD Applications
- Precision Sense Amplifier and Bandgap Reference
- Built-in AC Rectifier
- Direct DC Coupled to Sense Coil
- Built-in Noise Filter
- Low-voltage SCR Disable
- SCR Gate Driver
- Adjustable Sensitivity
- Minimum External Components
- Meets UL 943B Requirements
- Ideal for 120 V or 220 V Systems
- Space-saving SUPERSOT 6-pin Package
- These Devices are Pb-Free and are RoHS Compliant

### Applications

- Personal Care Products
- Two-wire Electrical Outlets, Circuit Breakers, and Power Cords Requiring GFI Safety Features
- ALCI and RCCB Circuits



ON Semiconductor®

[www.onsemi.com](http://www.onsemi.com)



TSOT23 6-Lead  
CASE 419BL

### MARKING DIAGRAM

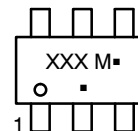

XXX = Specific Device Code  
M = Date Code  
▪ = Pb-Free Package

### ORDERING INFORMATION

See detailed ordering and shipping information on page 9 of this data sheet.

# FAN4146

## TYPICAL APPLICATIONS

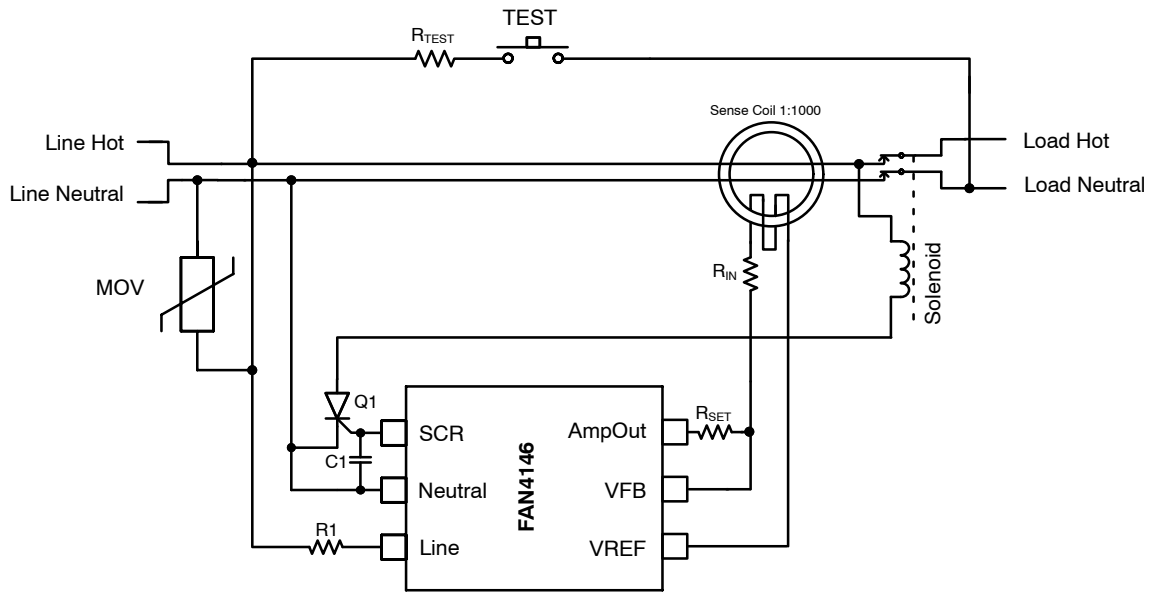

**Typical Values:**

R1: 91 k $\Omega$  (Wattage Determined by Maximum  $V_{AC}$ )       $R_{IN}$ : 470  $\Omega$   
 $R_{TEST}$ : 15 k $\Omega$       C1: 22 nF  
 $R_{SET}$ : 511 k $\Omega$  (Note 1)

**Notes:**

1. Value depends on sense-coil characteristics and application (value chosen for 5 mA trip threshold).
2. Contact ON Semiconductor for best application practices for nuisance tripping rejection.

**Figure 1. 120/220 V<sub>AC</sub> ALCI Application (Note 2)**

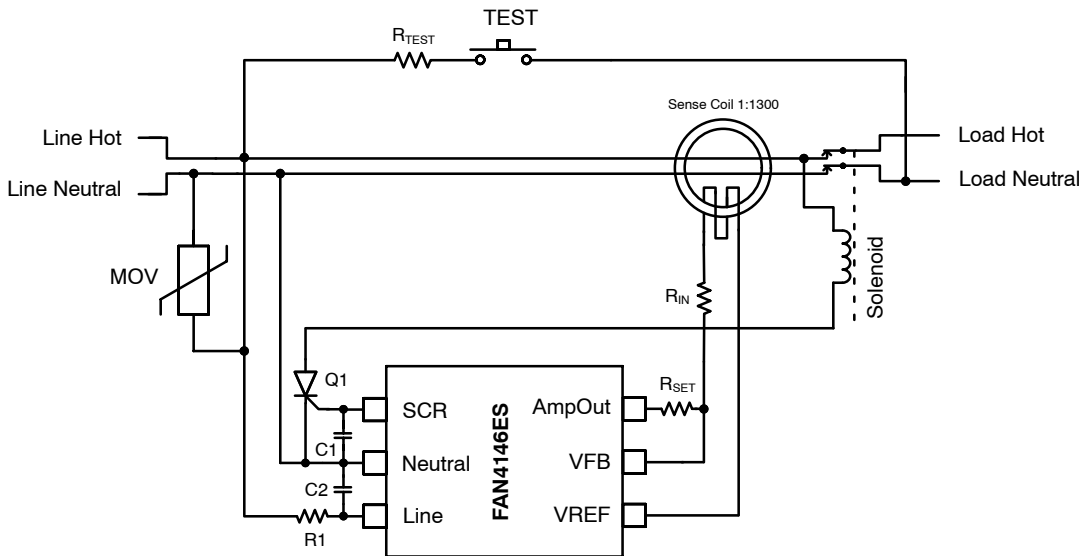

**Typical Values:**

R1: 174 k $\Omega$  (Wattage Determined by Maximum  $V_{AC}$ )       $R_{SET}$ : 324 k $\Omega$  (Note 3)      C1: 22 nF  
 $R_{TEST}$ : 15 k $\Omega$        $R_{IN}$ : 470  $\Omega$       C2: 10 nF

**Notes:**

3. Value depends on sense-coil characteristics and application (value chosen for 10 mA trip threshold).
4. Contact ON Semiconductor for best application practices for nuisance tripping rejection.

**Figure 2. 220 V<sub>AC</sub> RCD Application (Note 4)**



# FAN4146

## ABSOLUTE MAXIMUM RATINGS

Symbol	Parameter	Condition	Min	Max	Unit
I <sub>CC</sub>	Supply Current	Continuous Current, Line to Neutral	–	15	mA
V <sub>CC</sub>	Supply Voltage	Continuous Voltage, Line to Neutral	–1.5	16.0	V
	All other pins	Continuous Voltage to Neutral	–0.8	15.0	V
T <sub>STG</sub>	Storage Temperature Range		–65	+150	°C
ESD	Electrostatic Discharge Capability	Human Body Model, JESD22–A114	–	2500	V
		Charged Device Model, JESD22–C101	–	1000	
		Machine Model, JESD22–A115	–	200	

Stresses exceeding those listed in the Maximum Ratings table may damage the device. If any of these limits are exceeded, device functionality should not be assumed, damage may occur and reliability may be affected.

## DC ELECTRICAL CHARACTERISTICS (Unless otherwise specified, T<sub>A</sub> = 25°C, I<sub>shunt</sub> = 1 mA.)

Symbol	Parameter	Condition	Min	Typ	Max	Unit
V <sub>REG</sub>	Power Supply Shunt Regulator Voltage	Line to Neutral	12.2	12.7	13.2	V
		Line to Neutral, I <sub>shunt</sub> = –2 mA	–0.9	–0.7	–	V
I <sub>Q</sub>	Quiescent Current	Line to Neutral = 10 V	350	400	450	μA
V <sub>REF</sub>	Reference Voltage	V <sub>REF</sub> to Neutral	5.8	6.0	6.2	V
V <sub>TH</sub>	Trip Threshold	AmpOut to V <sub>REF</sub>	3.4	3.5	3.6	V
V <sub>OS</sub>	Amplifier Offset	R <sub>SET</sub> = 511 kΩ, R <sub>IN</sub> = 500 Ω	–450	0	450	μV
I <sub>OS</sub>	Amplifier Input Offset (Note 5)	Design Value	–50	0	50	nA
G	Amplifier DC Gain (Note 5)	Design Value	–	100	–	dB
f <sub>GBW</sub>	Amplifier Gain Bandwidth (Note 5)	Design Value	–	1.5	–	MHz
V <sub>SW+</sub>	Amplifier Positive Voltage Swing	AmpOut to V <sub>REF</sub> , I <sub>FAULT</sub> = 10 μA	4.0	–	–	V
V <sub>SW–</sub>	Amplifier Negative Voltage Swing	V <sub>REF</sub> to AmpOut, I <sub>FAULT</sub> = –10 μA	4.0	–	–	V
I <sub>SINK</sub>	Amplifier Current Sink	AmpOut = V <sub>REF</sub> + 3 V, V <sub>FB</sub> = V <sub>REF</sub> + 100 mV	400	–	–	μA
I <sub>SRL</sub>	Amplifier Current Source	AmpOut = V <sub>REF</sub> – 3 V, V <sub>FB</sub> = V <sub>REF</sub> – 100 mV	400	–	–	μA
t <sub>d</sub>	Delay Filter	Delay from C <sub>1</sub> Trip to SCR, LOW to HIGH	0.75	1.00	1.25	ms
R <sub>OUT</sub>	SCR Output Resistance	SCR to Neutral = 250 mV, AmpOut = V <sub>REF</sub>	–	0.5	1.0	kΩ
V <sub>OUT</sub>	SCR Output Voltage	SCR to Neutral, AmpOut = V <sub>REF</sub>	–	1	10	mV
		SCR to Neutral, AmpOut = V <sub>REF</sub> + 4 V	2.5	–	–	V
I <sub>OUT</sub>	SCR Output Current	SCR to Neutral = 1 V, AmpOut = V <sub>REF</sub> + 4 V	350	500	–	μA

Product parametric performance is indicated in the Electrical Characteristics for the listed test conditions, unless otherwise noted. Product performance may not be indicated by the Electrical Characteristics if operated under different conditions.

5. Guaranteed by design; not tested in production.

**FUNCTIONAL DESCRIPTION**

(Refer to Figure 1 and Figure 3)

The FAN4146 is a two-wire GFCI controller for AC ground-fault-circuit interrupters. The internal rectifier circuit is biased by the AC line during the positive half cycle of the AC line voltage. The internal 12 V shunt regulator uses a precision temperature-compensated bandgap reference. The combination of precision reference circuitry and precision sense amplifier provides for an accurate ground-fault tolerance. This allows for selection of external components with wider and lower-cost parameter variation. Due to the low quiescent current, a high value external series resistor ( $R_1$ ) can be used which reduces the maximum power wattage required for this resistor. The 12 V shunt regulator generates the reference voltage  $V_{REF}$  for the sense amplifier's ( $A_1$ ) non-inverting input (AC ground reference) and supplies the bias for the delay timer ( $t_1$ ), comparators ( $C_1$  &  $C_2$ ), and the SCR driver.

The secondary winding of the sense transformer is directly DC coupled to the inverting input of the sense amplifier at pin 5 ( $V_{FB}$ ). The  $R_{SET}$  resistor converts the sense transformer's secondary current to a voltage at pin 6 (AmpOut). This voltage is compared to the internal window comparator ( $C_1$  &  $C_2$ ) and, when the AmpOut voltage exceeds the  $\pm V_{TH}$  threshold voltage, the window comparator triggers the internal delay timer. The output of the window comparator must stay HIGH for the duration of the  $t_1$  timer. If the window comparator's output momentarily goes LOW, the  $t_1$  timer resets. If the window comparator's output is still HIGH at the end of the  $t_1$  pulse, the SCR driver enables the current source  $I_1$  and disables  $Q_1$ . The current source  $I_1$  then enables the external SCR, which energizes the solenoid, opens the contact switches to the load, and removes the hazardous ground fault. The window comparator allows detection of a positive or negative  $I_{FAULT}$  signal independent from the phase of the line voltage. An internal under-voltage lockout circuit disables the SCR driver if the voltage at pin 3 (LINE) is below 7.5 V. This prevents the SCR from energizing the solenoid when the SCR's anode voltage is below 65 V.

The sense transformer typically has a toroidal core made of laminated steel rings or solid ferrite material. The secondary of the transformer is typically 1000 turns of #40 wire wound through the toroid. The primary is typically one turn made by passing the AC hot and neutral wires through the center of the toroid. When a ground fault exists, a difference exists between the current flowing in hot and neutral wires. The primary difference current divided by the primary-to-secondary turns ratio is the current that flows through the secondary wire of the transformer.

**Calculation of  $R_{SET}$  Resistor**

The AmpOut signal must exceed the window comparator's  $V_{TH}$  threshold voltage for longer than the delay timer and calculated by:

$$V_{TH} = I_{FAULT} \times 1.41 \times R_{SET} \times \frac{\cos\left(2\pi \times \frac{t}{2P}\right)}{N} \quad (\text{eq. 1})$$

$$R_{SET} = \frac{V_{TH} \times N}{1.41 \times I_{FAULT} \times \cos\left(\pi \times \frac{t}{P}\right)} \quad (\text{eq. 2})$$

where:

- $V_{TH}$  = 3.5 V
- $I_{FAULT}$  = 5 mA (UL943B)
- $t$  = 1 ms (timer delay)
- $P$  = Period of the AC Line (1/60 Hz)
- $N$  = Ratio of secondary to primary turns (1000:1)
- $R_{SET}$  = 505 k $\Omega$  (511 k $\Omega$  standard 1% value).

In practice, the transformer is non-ideal, so  $R_{SET}$  may need to be adjusted by up to 30% to obtain the desired  $I_{fault}$  trip threshold.

**Calculation of  $V_{OS}$  Trip Threshold Error**

Since the sense coil is directly connected to the feedback of the sense amplifier, the  $V_{OS}$  offset introduces an  $I_{fault}$  threshold error. This error can be calculated as follows:

$$\%Error = 100 \times \frac{V_{OS} \times R_{SET}}{R_{IN} + R_{LDC} + R_{LAC}} \times \frac{1}{V_{TH}} \quad (\text{eq. 3})$$

where:

- $V_{OS}$  =  $\pm 450$   $\mu$ V (worst case)  
=  $\pm 150$   $\mu$ V (typical)
- $R_{SET}$  = 511 k $\Omega$
- $R_{IN}$  = 470  $\Omega$  (typical value)
- $R_{LDC}$  = 75  $\Omega$  (sense coil secondary DC resistance)
- $R_{LAC}$  = 1.5 k $\Omega$  ( $AC_{(j\omega L)}$  impedance of sense coil),  
 $L = 4$  H,  $f = 60$  Hz
- $V_{TH}$  = 3.5 V
- $\%Error$  =  $\pm 3.2\%$  (worst case)  
= 1.1% (typical).

TYPICAL PERFORMANCE CHARACTERISTICS

(Unless otherwise specified,  $T_A = 25^\circ\text{C}$  and according to Figure 1 with SCR disconnected.)

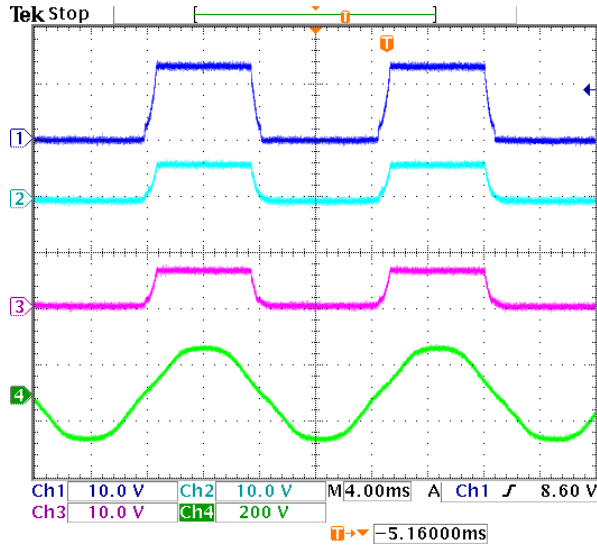

Ch1:  $V_{Line}$  (Pin 3), 10 V/Div  
 Ch2: AmpOut (Pin 6), 10 V/Div  
 Ch3:  $V_{REF}$  (Pin 4), 10 V/Div  
 Ch4:  $V_{AC}$  Input, 200 V/Div

Figure 5. Typical Waveforms, No Ground Fault

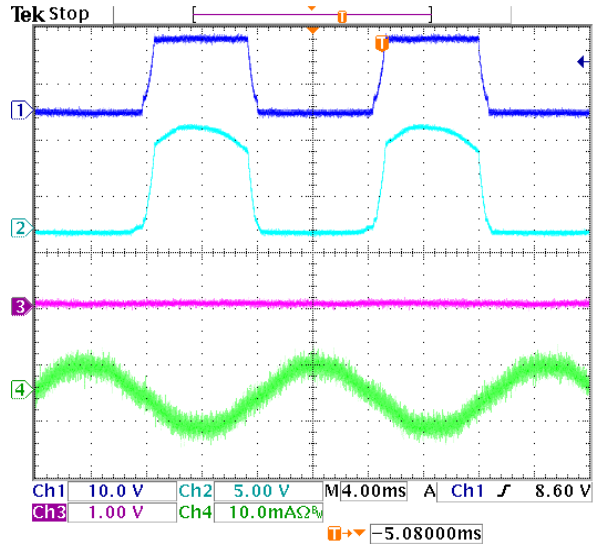

Ch1:  $V_{Line}$  (Pin 3), 10 V/Div  
 Ch2: AmpOut (Pin 6), 5 V/Div  
 Ch3: SCR (Pin 1), 1 V/Div  
 Ch4:  $I_{FAULT}$ , 10 mA/Div

Figure 6. Typical Waveforms, 4 mA Ground Fault

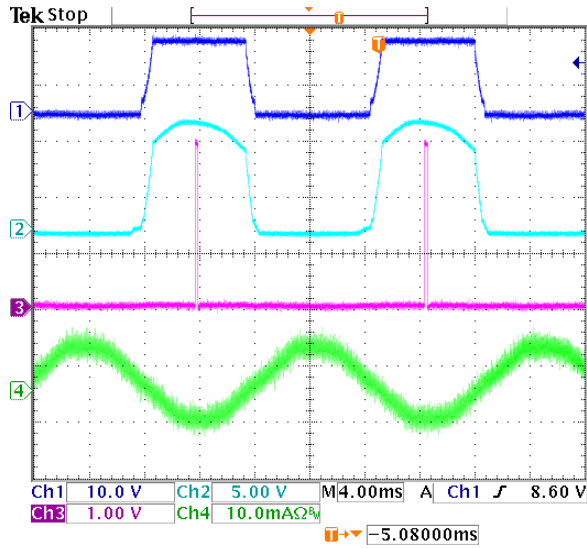

Ch1:  $V_{Line}$  (Pin 3), 10 V/Div  
 Ch2: AmpOut (Pin 6), 5 V/Div  
 Ch3: SCR (Pin 1), 1 V/Div  
 Ch4:  $I_{FAULT}$ , 10 mA/Div

Figure 7. Typical Waveforms, 5 mA Ground Fault

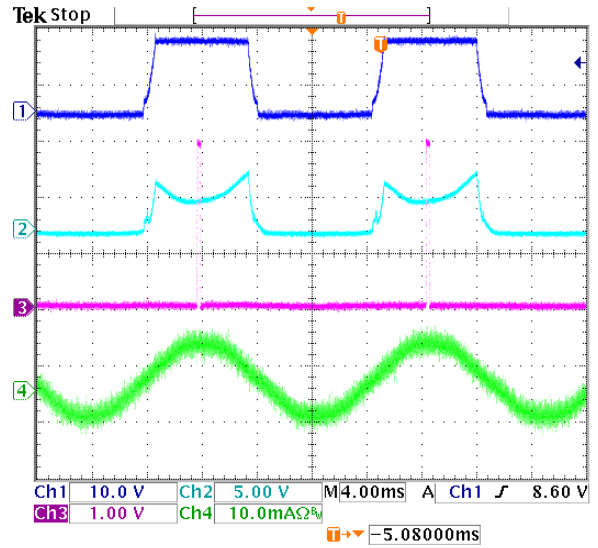

Ch1:  $V_{Line}$  (Pin 3), 10 V/Div  
 Ch2: AmpOut (Pin 6), 5 V/Div  
 Ch3: SCR (Pin 1), 1 V/Div  
 Ch4:  $I_{FAULT}$ , 10 mA/Div

Figure 8. Typical Waveforms, 5 mA Ground Fault (Line Polarity Reversal)

# FAN4146

## TYPICAL PERFORMANCE CHARACTERISTICS (Continued)

(Unless otherwise specified,  $T_A = 25^\circ\text{C}$  and according to Figure 1 with SCR disconnected.)

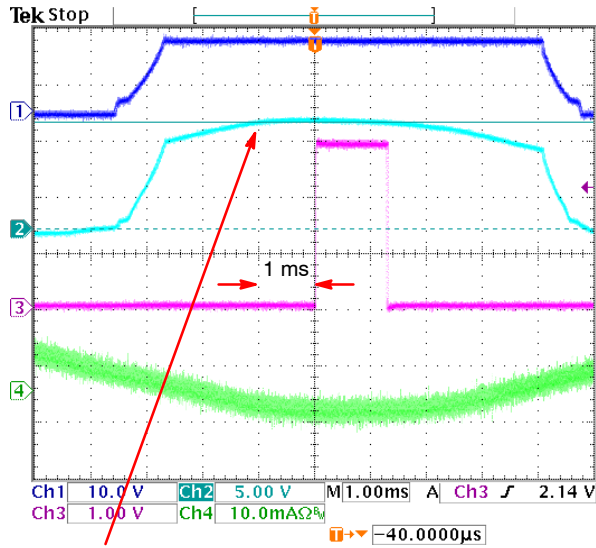

Ch1:  $V_{Line}$  (Pin 3), 10 V/Div  
 Ch2: AmpOut (Pin 6), 5 V/Div  
 Ch3: SCR (Pin 1), 1 V/Div  
 Ch4:  $I_{FAULT}$ , 10 mA/Div

Figure 9. AmpOut Threshold, Internal 1 ms Delay

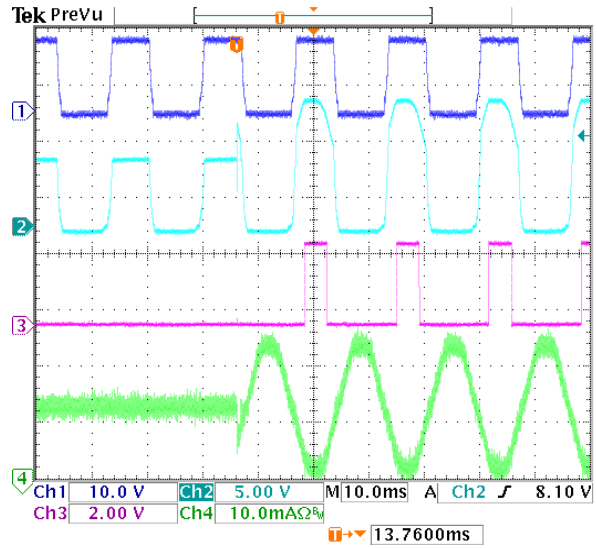

Ch1:  $V_{Line}$  (Pin 3), 10 V/Div  
 Ch2: AmpOut (Pin 6), 5 V/Div  
 Ch3: SCR (Pin 1), 2 V/Div  
 Ch4:  $I_{FAULT}$ , 10 mA/Div

Figure 10. 15 kΩ Ground Fault

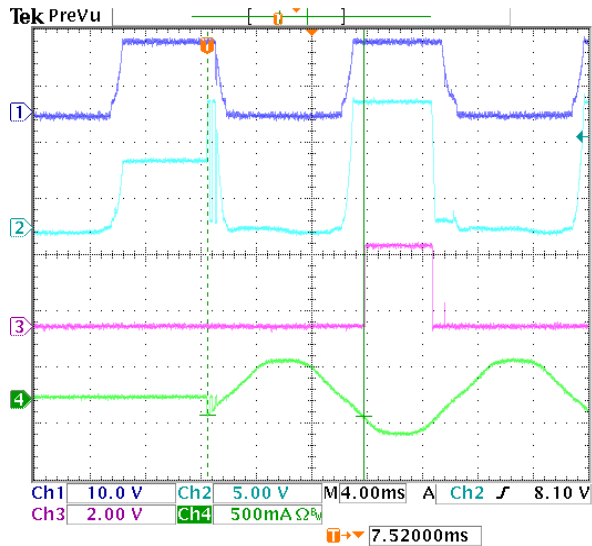

Ch1:  $V_{Line}$  (Pin 3), 10 V/Div  
 Ch2: AmpOut (Pin 6), 5 V/Div  
 Ch3: SCR (Pin 1), 2 V/Div  
 Ch4:  $I_{FAULT}$ , 500 mA/Div

Figure 11. 500 Ω Ground Fault (Notes 6, 7)

**Notes:**

- 6. Maximum trip time ~12 ms.
- 7. Fault occurs at the end of the positive AC cycle.

# FAN4146

## TYPICAL TEMPERATURE CHARACTERISTICS (FAN4146E)

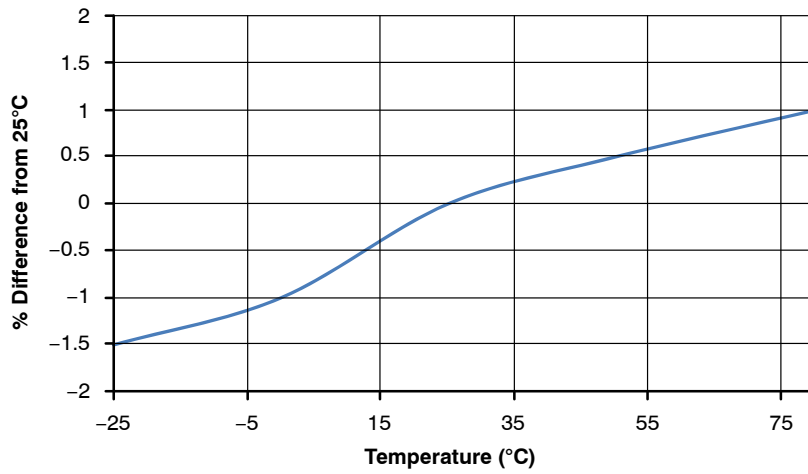

Figure 12. VThreshold (V<sub>TH</sub>) vs. Temperature

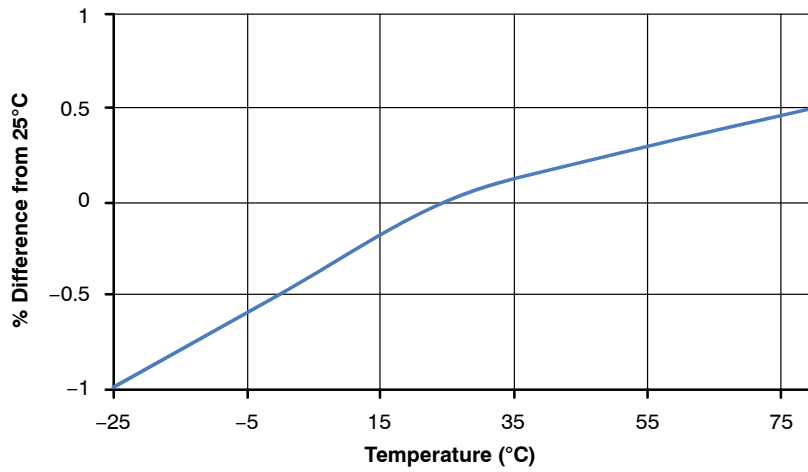

Figure 13. VReference (V<sub>REF</sub>) vs. Temperature

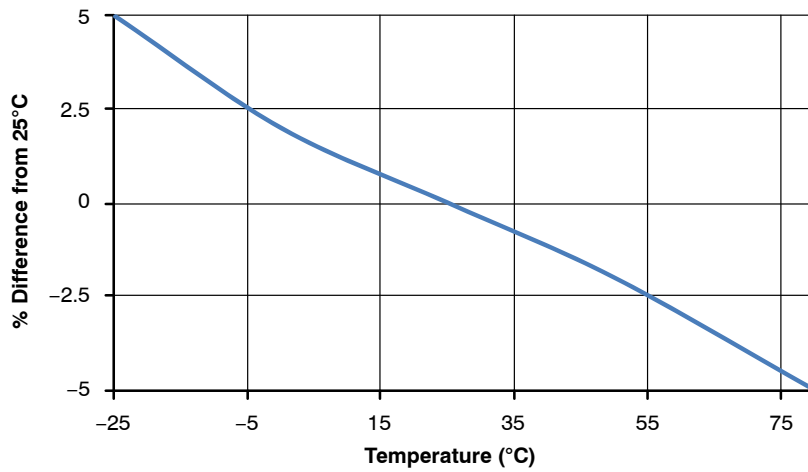

Figure 14. SCR Output Current (I<sub>OUT</sub>) vs. Temperature



# FAN4146

## ORDERING INFORMATION

<b>Part Number</b>	<b>Operating Temperature Range</b>	<b>Package</b>	<b>Shipping (Qty / Packing)<sup>†</sup></b>
FAN4146SX	0°C to +70°C	TSOT23 6-Lead (Pb-Free)	3,000 / Tape & Reel
FAN4146ESX	-35°C to +85°C	TSOT23 6-Lead (Pb-Free)	3,000 / Tape & Reel

<sup>†</sup>For information on tape and reel specifications, including part orientation and tape sizes, please refer to our Tape and Reel Packaging Specifications Brochure, BRD8011/D.

SUPERSOT is a trademark of Semiconductor Components Industries, LLC (SCILLC) or its subsidiaries in the United States and/or other countries.

# MECHANICAL CASE OUTLINE

## PACKAGE DIMENSIONS

ON Semiconductor®



1  
SCALE 2:1

### TSOT23 6-Lead CASE 419BL ISSUE A

DATE 31 AUG 2020

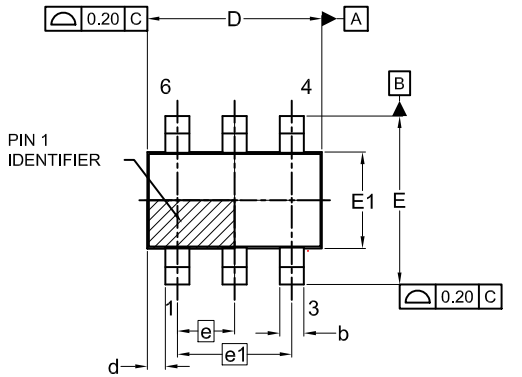

TOP VIEW

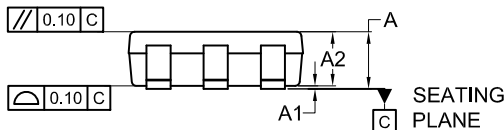

FRONT VIEW

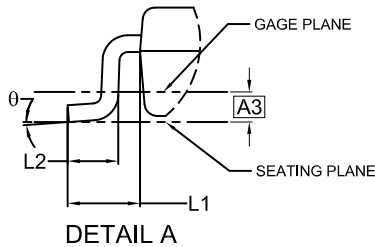

DETAIL A

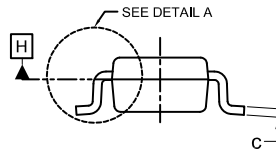

SIDE VIEW

SYMM  
⌀

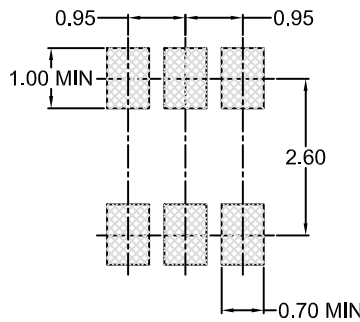

LAND PATTERN  
RECOMMENDATION

\*FOR ADDITIONAL INFORMATION ON OUR  
Pb-FREE STRATEGY AND SOLDERING DETAILS,  
PLEASE DOWNLOAD THE ON SEMICONDUCTOR  
SOLDERING AND MOUNTING TECHNIQUES  
REFERENCE MANUAL, SOLDERRM/D.

NOTES:

1. DIMENSIONING AND TOLERANCING PER ASME Y14.5M, 2009.
2. CONTROLLING DIMENSION: MILLIMETERS
3. DIMENSIONS D AND E1 DO NOT INCLUDE MOLD FLASH, PROTRUSIONS, OR GATE BURRS. MOLD FLASH, PROTRUSIONS OR GATE BURRS SHALL NOT EXCEED 0.25MM PER END. DIMENSIONS D AND E1 ARE DETERMINED AT DATUM H.
4. SEATING PLANE IS DEFINED BY THE TERMINALS. "A1" IS DEFINED AS THE DISTANCE FROM THE SEATING PLANE TO THE LOWEST POINT ON THE PACKAGE BODY.

DIM	MILLIMETERS		
	MIN.	NOM.	MAX.
A	0.90	1.00	1.10
A1	0.00	0.05	0.10
A2	0.70	0.85	1.00
A3	0.25 BSC		
b	0.25	0.38	0.50
c	0.10	0.18	0.26
D	2.80	2.95	3.10
d	0.30 REF		
E	2.50	2.75	3.00
E1	1.30	1.50	1.70
e	0.95 BSC		
e1	1.90 BSC		
L1	0.60 REF		
L2	0.20	0.40	0.60
⌀	0°	--	10°

#### GENERIC MARKING DIAGRAM\*

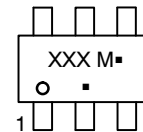

XXX = Specific Device Code  
M = Date Code  
▪ = Pb-Free Package

(Note: Microdot may be in either location)

\*This information is generic. Please refer to device data sheet for actual part marking. Pb-Free indicator, "G" or microdot "▪", may or may not be present. Some products may not follow the Generic Marking.

DOCUMENT NUMBER:	98AON83292G	Electronic versions are uncontrolled except when accessed directly from the Document Repository. Printed versions are uncontrolled except when stamped "CONTROLLED COPY" in red.
DESCRIPTION:	TSOT23 6-Lead	PAGE 1 OF 1

ON Semiconductor and ON are trademarks of Semiconductor Components Industries, LLC dba ON Semiconductor or its subsidiaries in the United States and/or other countries. ON Semiconductor reserves the right to make changes without further notice to any products herein. ON Semiconductor makes no warranty, representation or guarantee regarding the suitability of its products for any particular purpose, nor does ON Semiconductor assume any liability arising out of the application or use of any product or circuit, and specifically disclaims any and all liability, including without limitation special, consequential or incidental damages. ON Semiconductor does not convey any license under its patent rights nor the rights of others.

**onsemi**, **Onsemi**, and other names, marks, and brands are registered and/or common law trademarks of Semiconductor Components Industries, LLC dba "**onsemi**" or its affiliates and/or subsidiaries in the United States and/or other countries. **onsemi** owns the rights to a number of patents, trademarks, copyrights, trade secrets, and other intellectual property. A listing of **onsemi**'s product/patent coverage may be accessed at [www.onsemi.com/site/pdf/Patent-Marking.pdf](http://www.onsemi.com/site/pdf/Patent-Marking.pdf). **onsemi** reserves the right to make changes at any time to any products or information herein, without notice. The information herein is provided "as-is" and **onsemi** makes no warranty, representation or guarantee regarding the accuracy of the information, product features, availability, functionality, or suitability of its products for any particular purpose, nor does **onsemi** assume any liability arising out of the application or use of any product or circuit, and specifically disclaims any and all liability, including without limitation special, consequential or incidental damages. Buyer is responsible for its products and applications using **onsemi** products, including compliance with all laws, regulations and safety requirements or standards, regardless of any support or applications information provided by **onsemi**. "Typical" parameters which may be provided in **onsemi** data sheets and/or specifications can and do vary in different applications and actual performance may vary over time. All operating parameters, including "Typicals" must be validated for each customer application by customer's technical experts. **onsemi** does not convey any license under any of its intellectual property rights nor the rights of others. **onsemi** products are not designed, intended, or authorized for use as a critical component in life support systems or any FDA Class 3 medical devices or medical devices with a same or similar classification in a foreign jurisdiction or any devices intended for implantation in the human body. Should Buyer purchase or use **onsemi** products for any such unintended or unauthorized application, Buyer shall indemnify and hold **onsemi** and its officers, employees, subsidiaries, affiliates, and distributors harmless against all claims, costs, damages, and expenses, and reasonable attorney fees arising out of, directly or indirectly, any claim of personal injury or death associated with such unintended or unauthorized use, even if such claim alleges that **onsemi** was negligent regarding the design or manufacture of the part. **onsemi** is an Equal Opportunity/Affirmative Action Employer. This literature is subject to all applicable copyright laws and is not for resale in any manner.

## ADDITIONAL INFORMATION

### TECHNICAL PUBLICATIONS:

Technical Library: [www.onsemi.com/design/resources/technical-documentation](http://www.onsemi.com/design/resources/technical-documentation)  
onsemi Website: [www.onsemi.com](http://www.onsemi.com)

### ONLINE SUPPORT: [www.onsemi.com/support](http://www.onsemi.com/support)

For additional information, please contact your local Sales Representative at [www.onsemi.com/support/sales](http://www.onsemi.com/support/sales)