

NOTICE OF PROPRIETARY RIGHTS THIS DOCUMENT CONTAINS CONFIDENTIAL DATA, INCLUDING TRADE SECRETS, PROPRIETARY TO TIMES MICROWAVE SYSTEMS. DISCLOSURE OF THIS DATA IS EXPRESSLY CONDITIONED UPON YOUR ASSENT THAT ITS USE IS LIMITED TO USE WITH YOUR COMPANY ONLY. ANY OTHER USE IS STRICTLY PROHIBITED WITHOUT THE PRIOR WRITTEN CONSENT OF TIMES MICROWAVE SYSTEMS.

SYM	REVISION DESCRIPTION	DFTM	DATE	APPD	APPD
A	RELEASED FOR PRODUCTION	Joslen	2015.10.14	TZ	2015.10.14

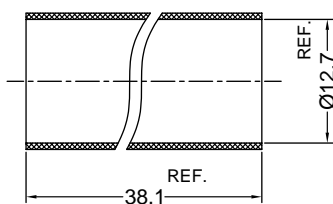

Heat Shrink Tube

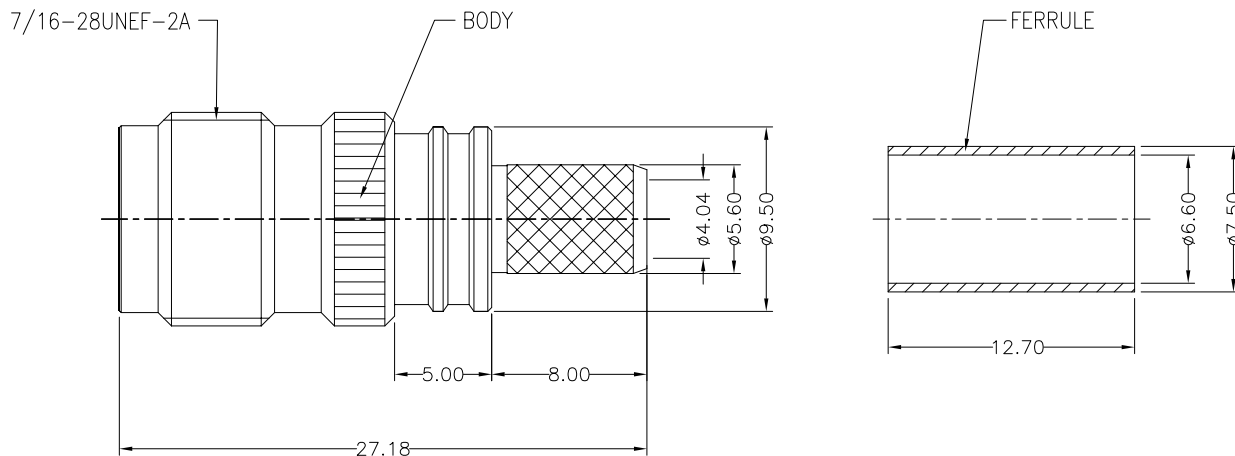
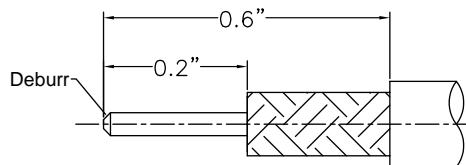

RECOMMENDED CABLE STRIPPING DIM'S
Connector adds: 12.5 mm

I. MATERIALS & FINISHES

Components	Materials	Finishes	Thk. (μ "
Body	Brass	Albaloy	80
Contact pin	QBe2	Gold	50
Ferrule	Brass	Albaloy	80
Insulator	PTFE	--	--

II. ELECTRICAL PROPERTIES

Impedance (Ω):	50
Frequency Range (GHz):	DC to 6 GHz
Working Voltage (V):	1500
Insulation Resistance (M Ω):	≥ 5000
VSWR:	≤ 1.30
Insertion Loss(dB, f/GHz):	$-0.1x \sqrt{f}$

III. ENVIRONMENT PROPERTIES

Temperature Range:	-55 $^{\circ}$ C~+155 $^{\circ}$ C
Thermal Shock:	MIL-STD 202G, Meth.107, Cond.B
Vibration:	MIL-STD 202G, Meth.204, Cond.B
Shock:	MIL-STD 202G, Meth.213, Cond I
Climatic Class:	IEC 60068 55/155/56
(2002/95/EC)RoHS:	Compliant





IV. MECHANICAL PROPERTIES

Center Cont.:	Captive
Outer Cont.:	Crimp
Coupling Nut Torque (N.m):	N/A
Cbl-Connector Retention Force (N):	200
Climatic Class:	IEC 60068 55/155/56
Durability (cycles):	500

V. TOOLING

Stripping Tool: 3192-152/CST240A
Crimping Tool: 3192-181/3190-608

According to Standard: IEC 61169-17

MATL:	UNLESS OTHERWISE SPECIFIED		DFTM.	Joslen	 An Amphenol Company						
	ALL DIMENSIONS ARE IN mm MACHINED SURFACES FINISH 1.6 RMS MAX. REMOVE ALL BURRS 0.15X45 $^{\circ}$ MAX. BREAK MACHINE CORNERS 0.15X45 $^{\circ}$ D MAX. FILLET R. TOLERANCES ON DECIMALS .X ± 0.3 .XX ± 0.15 ANGLES $\pm 2^{\circ}$ FRACTIONS \pm N/A		DATE	2015.10.14							
USED ON: O			CHKD	KG							
			DATE	2015.10.14							
SCALE:	DWG SIZE	DO NOT SCALE DRAWING	CODE IDENT	68999	DATE	2015.10.14		1 OF 1	3190-6204		A

EZ-240-TF-X
TNC Female (Jack) Straight
Non-Solder Pin No Braid Trim
Connector for LMR-240 Cable