

The product advantages



Euromas is a classic industrial enclosure which is available in three different material variants: ABS, polycarbonate and polycarbonate with UL 94 V-0 flame protection. A transparent cover allows a view into the enclosure.



The factory-fitted round cord seal can be replaced by a silicone seal with greater temperature resistance. Depending on the type, a higher protection class can also be achieved by using a moulded-in PU seal.

The lid screws – secured against falling out – are screwed into high-quality threaded bushings. No thread wear even when the enclosure is opened multiple times.

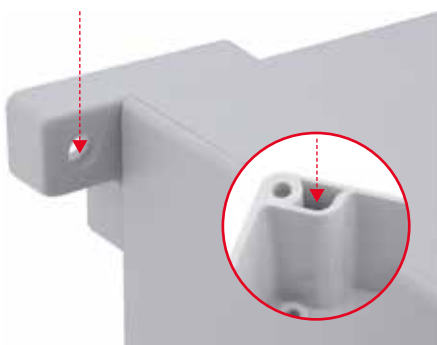

The enclosure can be fitted to the wall by means of the screw channels in the base or wall brackets.



Special versions with an F05 mounting flange in antistatic Vestamid plastic for applications on actuators and valves



Quick-Finder:
www.bopla.de/02

Examples of use



Euromas ABS | PC | F05



Colour:

- Light grey, similar to RAL 7035
- V 215: Black, similar to RAL 9005

Special colours on request

Protection class:

Depending on the model IP65 or IP66 / DIN EN 60529
IP68 (1.2 m- 2 h) on request from some sizes possible

Material:

Enclosure: ABS or PC (UV-stabilisiert) such as selected sizes in PC UL 94 V-0
(other UL 94 V-0 versions on request)
V215: Vestamid
Seal: CR

For details see technical information.



Enclosure sizes

M / T 205
M / T 206



M / T 208



M / T 210
M / T 215
M / T 216



M / T 217



M / T 219
M / T 220



M / T 221

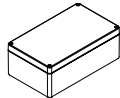

M / T 223

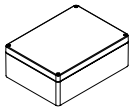

M / T 225
M / T 226

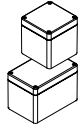

M / T 227
M / T 228

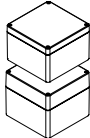

M / T 230
M / T 231
M / T 235

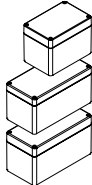

M / T 237
M / T 238
M / T 2381

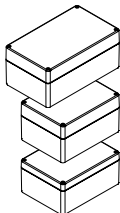

M / T 240
M / T 2401
M / T 241

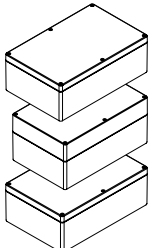

M / T 242

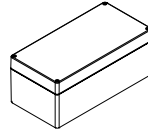

M / T 243

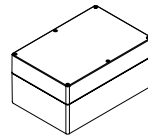

M / T 244
M / T 245

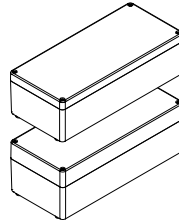

M / T 246

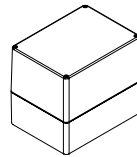

M / T 250
M / T 251

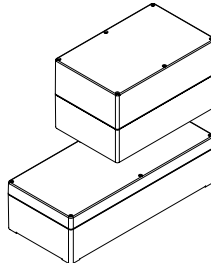

M / T 252
M / T 253
M / T 254

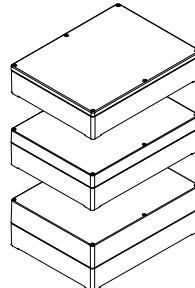

M / T 255

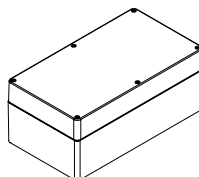

T 260

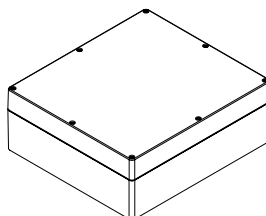

Design types

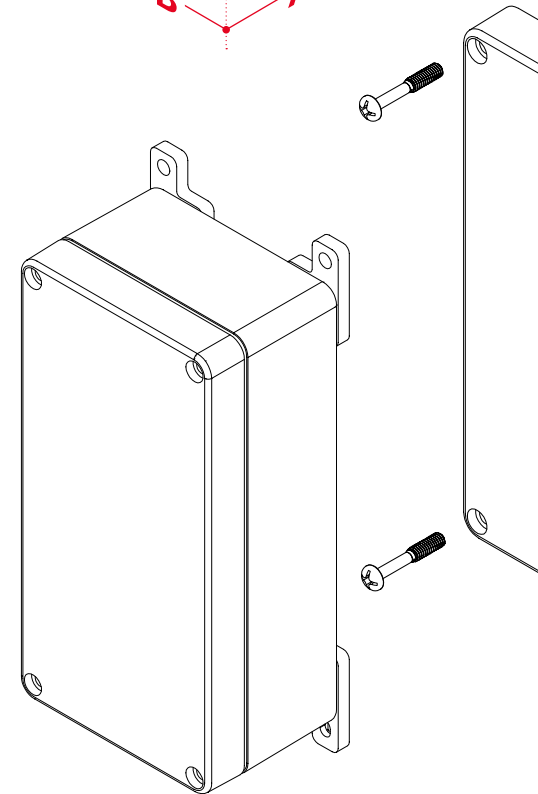
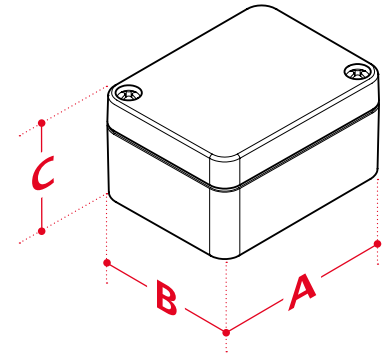

Crystal-clear cover (G)

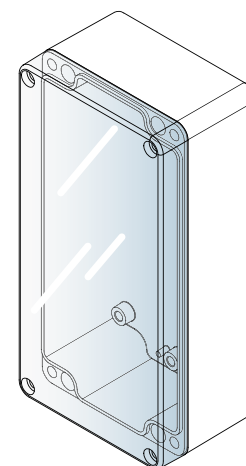

Euromas ABS | PC | F05

Screw-on wall brackets
as an alternative

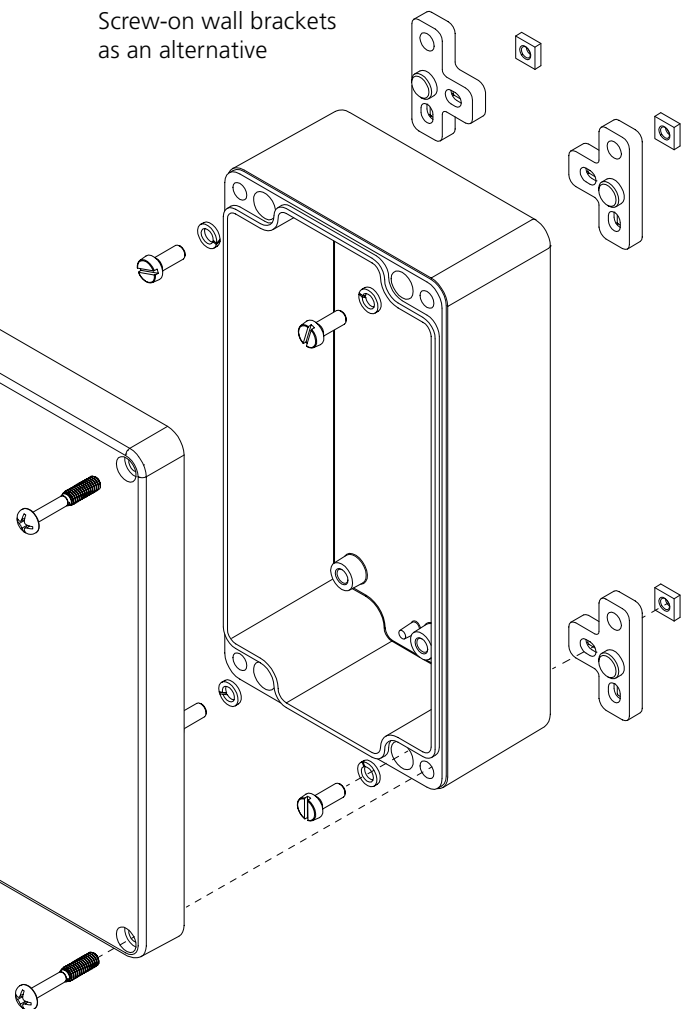

V 215 F05
Variant with F05 holder

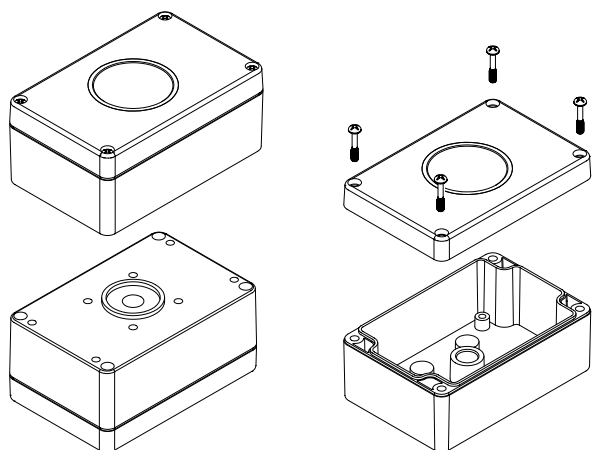

Dimensions

Modell	A	B	C	G	V0*
M / T 205	52	50	35	✓	✓
M / T 206	65	50	35	✓	✓
M / T 208	98	64	36.4		✓
M / T 210	82	80	55	✓	✓
M / T 215	120	80	55	✓	✓
M / T 216	120	80	60	✓	
M / T 217	122	120	55	✓	✓
M / T 219	160	80	60		
M / T 220	160	80	55	✓	✓
M / T 221	200	120	75	✓	✓
M / T 223	200	150	75	✓	✓
M / T 225	82	80	85	✓	✓
M / T 226	120	80	85	✓	✓
M / T 227	122	120	85	✓	✓
M / T 228	122	120	105	✓	✓
M / T 230	120	80	90		
M / T 231	160	80	85	✓	✓
M / T 235	160	80	90		✓
M / T 237	200	120	90	✓	
M / T 238	160	120	90	✓	✓
M / T 2381	160	120	75	✓	
M / T 240	250	160	90	✓	
M / T 2401	240.3	160.3	90	✓	✓
M / T 241	250	160	119		
M / T 242	240.5	120	100.5	✓	✓
M / T 243	240.3	160.3	120	✓	
M / T 244	340	150	100	✓	
M / T 245	340	150	120		
M / T 246	160	120	140	✓	
M / T 250	250	160	150		
M / T 251	360	160	100		
M / T 252	300	230	65		
M / T 253	300	230	85	✓	
M / T 254	300	230	110	✓	
M / T 255	360	200	149.5	✓	
T 260	360	400	150		
V 215 F05...	120	80	55		✓

* V0 = version using UL 94 V0 enclosure material

Accessories



Knurled screws / Rubber feet



DIN rails
TH 15, G 32, TH 35



Mast mounting

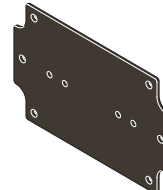

Mounting panels in different versions

Euromas ABS / PC / F05

ABS, einfarbig

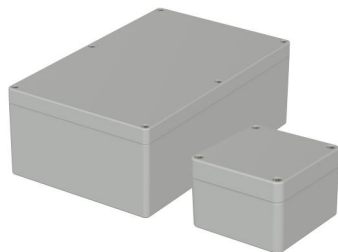

Gehäuse, ABS

Model	Order no.	A	B	C	a1	a2	b1	b2	b3	c1	c2	IP
T 205	03205000	52	50	35	46.4	30	44.4	28.2	-	10	31	66
T 205 SV	03205400*	52	50	35	46.4	30	44.4	28.2	-	10	31	65
T 206	03206000	65	50	35	59.4	43	44	27.7	-	10	29.5	66
T 206 SV	03206400*	65	50	35	59.4	43	44	27.7	-	10	29.5	65
T 208	03208000	98	64	36.4	89.4	74	55.4	32	-	9.2	29.4	66
T 208 SV	03208400*	98	64	36.4	89.4	74	55.4	32	-	9.2	29.4	65
T 210	03210000	82	80	55	75.3	56.6	73.3	36.5	-	15	49	66
T 210 SV	03210400*	82	80	55	75.3	56.6	73.3	36.5	-	15	49	65
T 215	03215000	120	80	55	113.3	94.5	73.3	36.5	-	15	49.5	66
T 215 SV	03215400*	120	80	55	113.3	94.5	73.3	36.5	-	15	49.5	65
T 216	03216000	120	80	60	113.3	94.5	73.3	36.5	-	20	54	66
T 216 SV	03216400*	120	80	60	113.3	94.5	73.3	36.5	-	20	54	65
T 217	03217000	122	120	55	115.3	96.5	113.3	76.5	-	15	48	65
T 217 SV	03217400*	122	120	55	115.3	96.5	113.3	76.5	-	15	48	65
T 219	03219000	160	80	60	153.5	134.7	73.5	36.7	-	20	54	66
T 219 SV	03219400*	160	80	60	153.5	134.7	73.5	36.7	-	20	54	65
T 220	03220000	160	80	55	153.5	134.7	73.5	36.7	-	15	49	66
T 220 SV	03220400*	160	80	55	153.5	134.7	73.5	36.7	-	15	49	65
T 221	03221000	200	120	75	193	174.2	113	74.2	-	15	68.5	66
T 221 SV	03221400*	200	120	75	193	174.2	113	74.2	-	15	68.5	65
T 223	03223000	200	150	75	193	174	143	105	-	15	68.5	65
T 223 SV	03223400*	200	150	75	193	174	143	105	-	15	68.5	65
T 225	03225000	82	80	85	75	56	73	36	-	15	79	66
T 225 SV	03225400*	82	80	85	75	56	73	36	-	15	79	65
T 226	03226000	120	80	85	113	94	73	36	-	15	79.5	65
T 226 SV	03226400*	120	80	85	113	94	73	36	-	15	79.5	65
T 227	03227000	122	120	85	115	96.2	113	76.2	-	15	78	66
T 227 SV	03227400*	122	120	85	115	96.2	113	76.2	-	15	78	65
T 228	03228000	122	120	105	115	96.2	113	76.2	-	35	98.5	66
T 230	03230000	120	80	90	113	94	73	36	-	20	84	66
T 230 SV	03230400*	120	80	90	113	94	73	36	-	20	84	65
T 231	03231000	160	80	85	153	134	73	36	-	15	79	66
T 231 SV	03231400*	160	80	85	153	134	73	36	-	15	79	65
T 235	03235000	160	80	90	153	134	73	36	-	20	84	66
T 235 SV	03235400*	160	80	90	153	134	73	36	-	20	84	65
T 237	03237000	200	120	90	193	174.2	113	74.2	-	30	83.5	66
T 237 SV	03237400*	200	120	90	193	174.2	113	74.2	-	30	83.5	65
T 238	03238000	160	120	90	153	134.2	113	74.2	-	30	83.5	66
T 238 SV	03238400*	160	120	90	153	134.2	113	74.2	-	30	83.5	65
T 2381	03238200	160	120	75	153	134.2	113	74.2	-	15	68.5	66
T 240	03240000	250	160	90	243	224	153	115	134	15	84	65
T 240 SV	03240400*	250	160	90	243	224	153	115	134	15	84	65
T 2401	03240200	240.3	160.3	90	233	214.7	153	116.7	134.7	15	84	66
T 2401 SV	03240240*	240.3	160.3	90	233	214.7	153	116.7	134.7	15	84	65
T 241	03241000	250	160	119	243	224	153	115	134	44	113	66
T 241 SV	03241400*	250	160	119	243	224	153	115	134	44	113	65
T 242	03242000	240.5	120	100.5	233.5	216.2	113	76.9	-	25	94	66
T 243	03243000	240.3	160.3	120	233	214.7	153	116.7	134.7	45	113.5	66
T 243 SV	03243400*	240.3	160.3	120	233	214.7	153	116.7	134.7	45	113.5	65
T 244	03244000	340	150	100	329.3	301.3	139.3	87.3	-	20	92.5	65

* = Available on request

Euromas ABS / PC / F05

ABS, einfarbig

Gehäuse, ABS

Model	Order no.	A	B	C	a1	a2	b1	b2	b3	c1	c2	IP
T 245	03245000	340	150	120	329.3	301.3	139.3	87.3	-	40	113	66
T 246	03246000	160	120	140	153	134.2	113	74.2	-	80	133.5	66
T 250	03250000	250	160	150	243	224	153	115	134	75	144	66
T 251	03251000	360	160	100	351.7	333.7	151.7	113.7	134.7	25	93.5	66
T 253	03253000	300	230	85	293.1	274.1	223.1	186.1	204.1	30	78.5	65
T 253 SV	03253400*	300	230	85	293.1	274.1	223.1	186.1	204.1	30	78.5	65
T 254	03254000	300	230	110	293.1	274.1	223.1	186.1	204.1	55	103.5	65
T 254 SV	03254400*	300	230	110	293.1	274.1	223.1	186.1	204.1	55	103.5	65
T 255	03255000	360	200	149.5	350.3	318.3	190.3	138.3	159.3	49.5	142	66
T 255 SV	03255400*	360	200	149.5	350.3	318.3	190.3	138.3	159.3	49.5	142	65
T 260	03260000	360	400	150	350.3	318.3	390.3	338.3	358.3	50	142	66

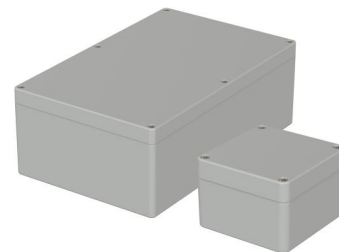

Scope Of Delivery:

Ober- und Unterteil, Deckelschrauben aus V2A, selbstformende Schrauben für die Montagenocken

Notes: SV = Ausführung mit Schnellverschluss. IP = Schutzart nach DIN EN 60529 ABS-Gehäuse können aufgrund einer anderen Materialschwindung ca. 0,1 - 0,25 % größer sein.

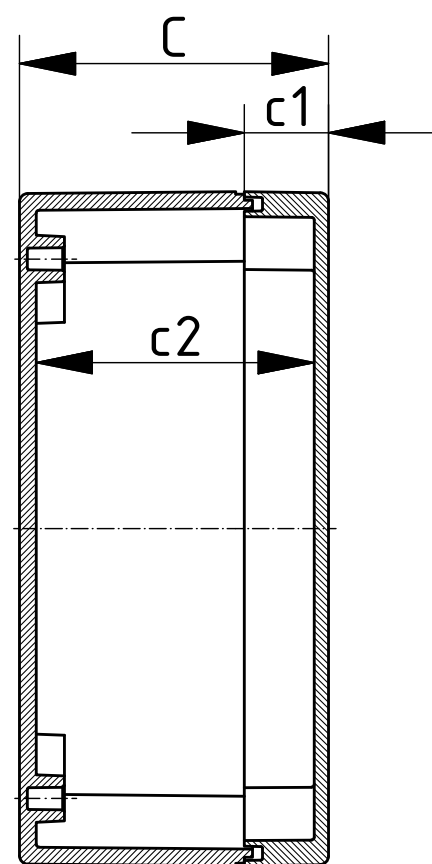
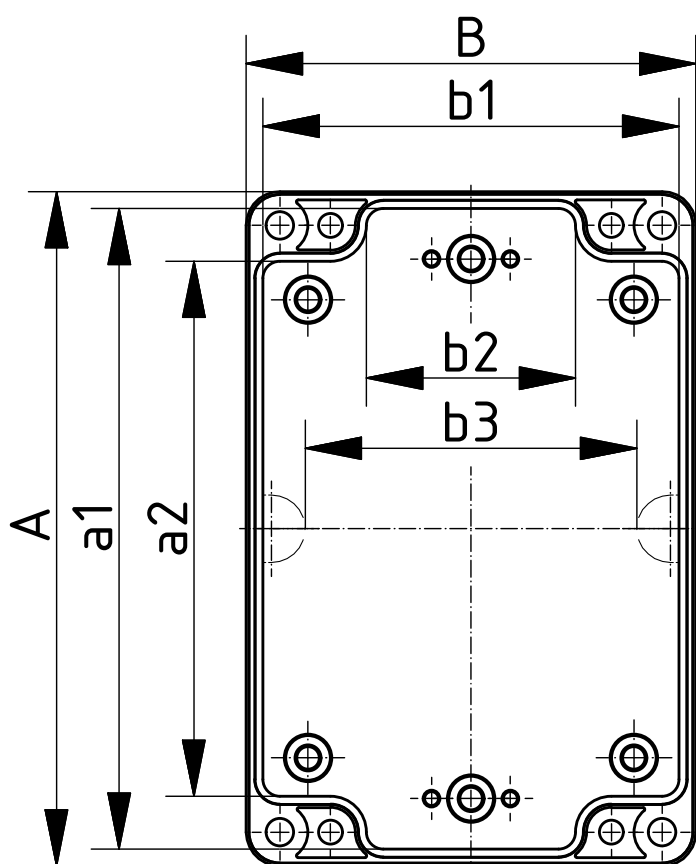

Z-2503224

Euromas ABS / PC / F05

PC, einfarbig

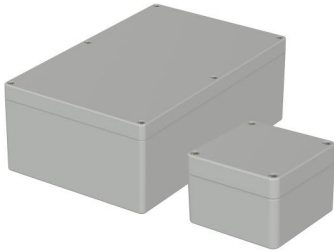

Gehäuse, Polycarbonat

Model	Order no.	A	B	C	a1	a2	b1	b2	b3	c1	c2	IP	IK
M 205	02205000	52	50	35	46.4	30	44.4	28.2	-	10	31	66	07
M 206	02206000	65	50	35	59.4	43	44	27.7	-	10	29.5	66	07
M 208	02208000	98	64	36.4	89.4	74	55.4	32	-	9.2	29.4	66	07
M 210	02210000	82	80	55	75.3	56.6	73.3	36.5	-	15	49	66	07
M 215	02215000	120	80	55	113.3	94.5	73.3	36.5	-	15	49.5	66	07
M 216	02216000	120	80	60	113.3	94.5	73.3	36.5	-	20	54	66	07
M 217	02217000	122	120	55	115.3	96.5	113.3	76.5	-	15	48	66	07
M 219	02219000	160	80	60	153.5	134.7	73.5	36.7	-	20	54	66	07
M 220	02220000	160	80	55	153.5	134.7	73.5	36.7	-	15	49	66	07
M 221	02221000	200	120	75	193	174.2	113	74.2	-	15	68.5	66	07
M 223	02223000	200	150	75	193	174	143	105	-	15	68.5	65	07
M 225	02225000	82	80	85	75	56	73	36	-	15	79	66	07
M 226	02226000	120	80	85	113	94	73	36	-	15	79.5	65	07
M 227	02227000	122	120	85	115	96.2	113	76.2	-	15	78	65	07
M 228	02228000	122	120	105	115	96.2	113	76.2	-	35	98.5	66	07
M 230	02230000	120	80	90	113	94	73	36	-	20	84	66	07
M 231	02231000	160	80	85	153	134	73	36	-	15	79	66	07
M 235	02235000	160	80	90	153	134	73	36	-	20	84	65	07
M 237	02237000	200	120	90	193	174.2	113	74.2	-	30	83.5	66	07
M 238	02238000	160	120	90	153	134.2	113	74.2	-	30	83.5	66	07
M 2381	02238200	160	120	75	153	134.2	113	74.2	-	15	68.5	65	07
M 240	02240000	250	160	90	243	224	153	115	134	15	84	65	07
M 2401	02240200	240.3	160.3	90	233	214.7	153	116.7	134.7	15	84	66	07
M 241	02241000	250	160	119	243	224	153	115	134	44	113	66	07
M 242	02242000	240.5	120	100.5	233.5	216.2	113	76.9	-	25	94	66	07
M 243	02243000	240.3	160.3	120	233	214.7	153	116.7	134.7	45	113.5	66	07
M 244	02244000	340	150	100	329.3	301.3	139.3	87.3	-	20	92.5	66	07
M 245	02245000	340	150	120	329.3	301.3	139.3	87.3	-	40	113	66	07
M 246	02246000	160	120	140	153	134.2	113	74.2	-	80	133.5	66	07
M 250	02250000	250	160	150	243	224	153	115	134	75	144	66	07
M 251	02251000	360	160	100	351.7	333.7	151.7	113.7	134.7	25	93.5	66	07
M 252	02252000	300	230	65	293.1	274.1	223.1	186.1	204.1	10	58.5	65	07
M 253	02253000	300	230	85	293.1	274.1	223.1	186.1	204.1	30	78.5	65	07
M 254	02254000	300	230	110	293.1	274.1	223.1	186.1	204.1	55	103.5	65	07
M 255	02255000	360	200	149.5	350.3	318.3	190.3	138.3	159.3	49.5	142	66	07

Scope Of Delivery:

Ober- und Unterteil, Deckelschrauben aus V2A, selbstformende Schrauben für die Montagenocken

Notes: G = Ausführung mit glasklarem Deckel. IP = Schutzart nach DIN EN 60529

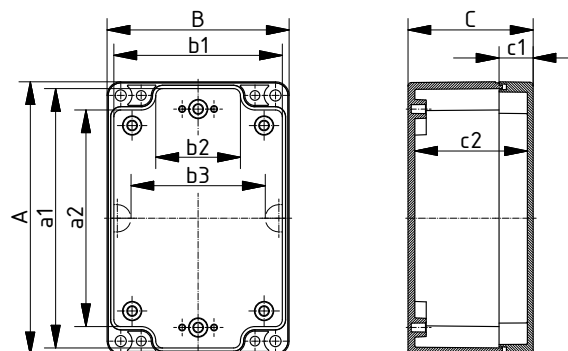

Z-2503224

Euromas ABS / PC / F05

PC, glasklarer Deckel

Gehäuse, Polycarbonat

Model	Order no.	A	B	C	a1	a2	b1	b2	b3	c1	c2	IP	IK
M 205 G	02205400	52	50	35	46.4	30	44.4	28.2	-	10	31	66	07
M 206 G	02206200	65	50	35	59.4	43	44	27.7	-	10	29.5	66	07
M 210 G	02210100	82	80	55	75.3	56.6	73.3	36.5	-	15	49	66	07
M 215 G	02215100	120	80	55	113.3	94.5	73.3	36.5	-	15	49.5	66	07
M 216 G	02216100*	120	80	60	113.3	94.5	73.3	36.5	-	20	54	66	07
M 217 G	02217200	122	120	55	115.3	96.5	113.3	76.5	-	15	48	66	07
M 220 G	02220100	160	80	55	153.5	134.7	73.5	36.7	-	15	49	66	07
M 221 G	02221100	200	120	75	193	174.2	113	74.2	-	15	68.5	66	07
M 223 G	02223100	200	150	75	193	174	143	105	-	15	68.5	65	07
M 225 G	02225100	82	80	85	75	56	73	36	-	15	79	66	07
M 226 G	02226100	120	80	85	113	94	73	36	-	15	79.5	65	07
M 227 G	02227100	122	120	85	115	96.2	113	76.2	-	15	78	65	07
M 228 G	02228100	122	120	105	115	96.2	113	76.2	-	35	98.5	66	07
M 231 G	02231100	160	80	85	153	134	73	36	-	15	79	66	07
M 237 G	02237100	200	120	90	193	174.2	113	74.2	-	30	83.5	66	07
M 238 G	02238100	160	120	90	153	134.2	113	74.2	-	30	83.5	66	07
M 2381 G	02238300	160	120	75	153	134.2	113	74.2	-	15	68.5	66	07
M 240 G	02240100	250	160	90	243	224	153	115	134	15	84	65	07
M 2401 G	02240300	240.3	160.3	90	233	214.7	153	116.7	134.7	15	84	65	07
M 242 G	02242100	240.5	120	100.5	233.5	216.2	113	76.9	-	25	94	65	07
M 243 G	02243100	240.3	160.3	120	233	214.7	153	116.7	134.7	45	113.5	66	07
M 244 G	02244100	340	150	100	329.3	301.3	139.3	87.3	-	20	92.5	66	07
M 246 G	02246100	160	120	140	153	134.2	113	74.2	-	80	133.5	66	07
M 253 G	02253100	300	230	85	293.1	274.1	223.1	186.1	204.1	30	78.5	66	07
M 254 G	02254100	300	230	110	293.1	274.1	223.1	186.1	204.1	55	103.5	66	07
M 255 G	02255100	360	200	149.5	350.3	318.3	190.3	138.3	159.3	49.5	142	65	07



Scope Of Delivery:

Ober- und Unterteil, Deckelschrauben aus V2A, selbstformende Schrauben für die Montagenocken

Notes: G = Ausführung mit glasklarem Deckel. IP = Schutzart nach DIN EN 60529

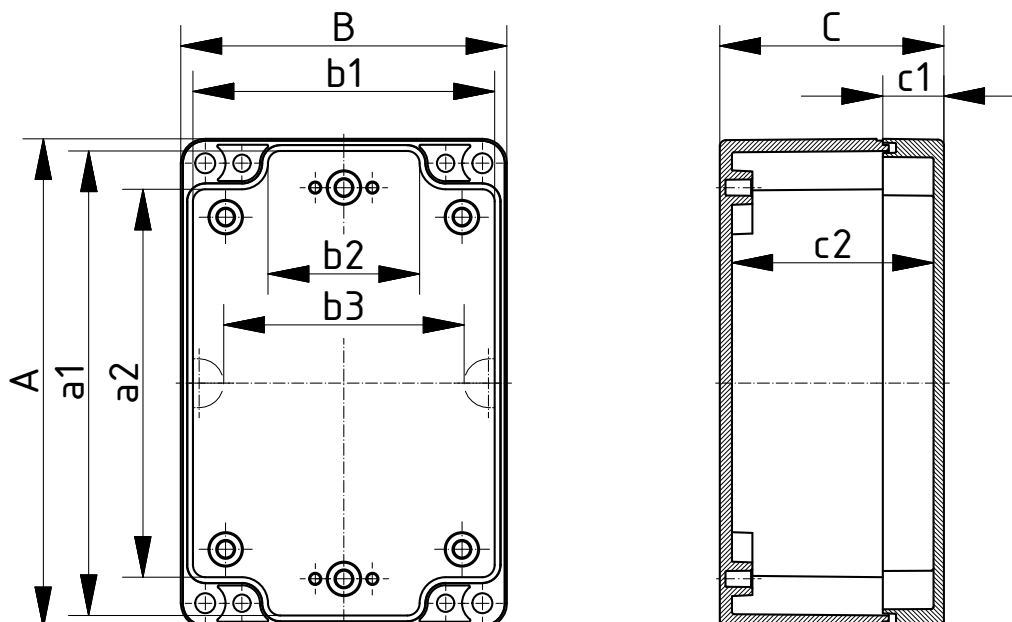

Z-2503224

Euromas ABS / PC / F05

PC UL 94 V0, einfarbig

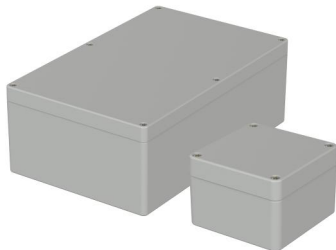

Gehäuse, Polycarbonat V0

Model	Order no.	A	B	C	a1	a2	b1	b2	b3	c1	c2	IP	IK
M 205 V0	02205094	52	50	35	46.4	30	44.4	28.2	-	10	31	66	07
M 206 V0	02206094	65	50	35	59.4	43	44	27.7	-	10	29.5	66	07
M 208 V0	02208094	98	64	36.4	89.4	74	55.4	32	-	9.2	29.4	66	07
M 210 V0	02210094	82	80	55	75.3	56.6	73.3	36.5	-	15	49	66	07
M 215 V0	02215094	120	80	55	113.3	94.5	73.3	36.5	-	15	49.5	66	07
M 217 V0	02217094	122	120	55	115.3	96.5	113.3	76.5	-	15	48	66	07
M 220 V0	02220094	160	80	55	153.5	134.7	73.5	36.7	-	15	49	66	07
M 221 V0	02221094	200	120	75	193	174.2	113	74.2	-	15	68.5	66	07
M 223 V0	02223094	200	150	75	193	174	143	105	-	15	68.5	65	07
M 225 V0	02225094	82	80	85	75	56	73	36	-	15	79	66	07
M 226 V0	02226094	120	80	85	113	94	73	36	-	15	79.5	65	07
M 227 V0	02227094	122	120	85	115	96.2	113	76.2	-	15	78	66	07
M 228 V0	02228094	122	120	105	115	96.2	113	76.2	-	35	98.5	66	07
M 231 V0	02231094	160	80	85	153	134	73	36	-	15	79	66	07
M 237 V0	02237094	200	120	90	193	174.2	113	74.2	-	30	83.5	66	07
M 238 V0	02238094	160	120	90	153	134.2	113	74.2	-	30	83.5	66	07
M 2401 V0	02240294	240.3	160.3	90	233	214.7	153	116.7	134.7	15	84	66	07
M 242 V0	02242094	240.5	120	100.5	233.5	216.2	113	76.9	-	25	94	66	07
M 255 V0	02255094	360	200	149.5	350.3	318.3	190.3	138.3	159.3	49.5	142	66	07

Scope Of Delivery:

Ober- und Unterteil, Deckelschrauben aus V2A, selbstformende Schrauben für die Montagenocken

Notes: V0 = Ausführung in UL 94 V0 - Gehäusematerial. IP = Schutzart nach DIN EN 60529

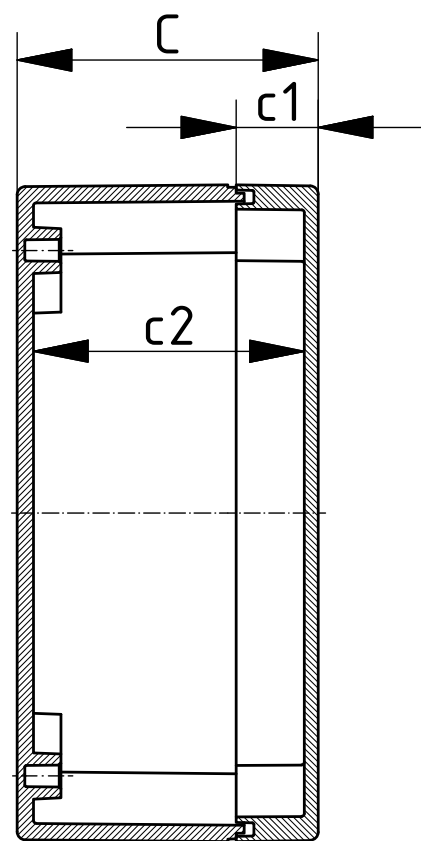
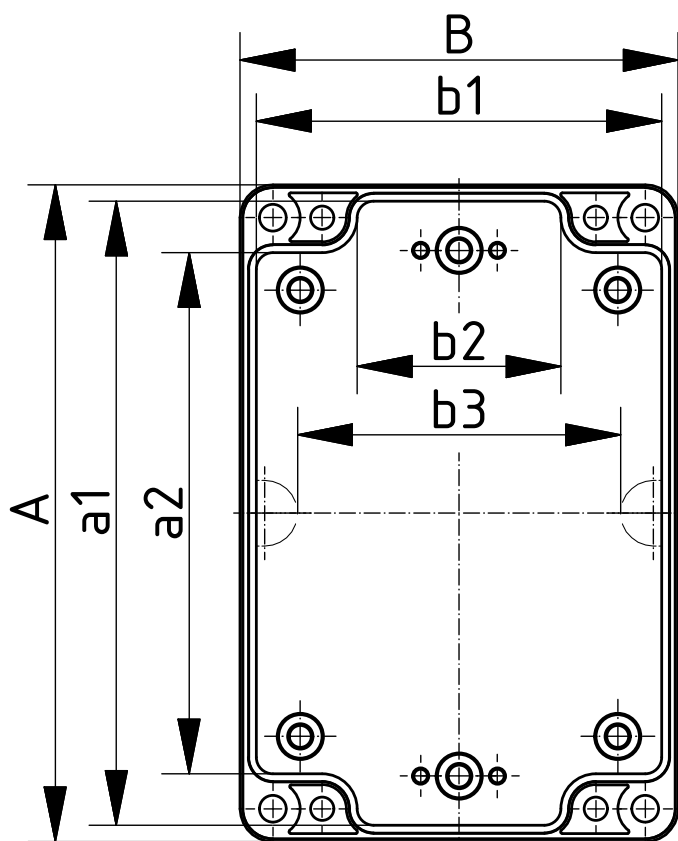

Z-2503224

Euromas ABS / PC / F05

Gehäuse mit F05-Aufnahme

Gehäuse, Vestamid mit F05-Aufnahme, schwarz, IP 65

Model	Order no.	A	B	C	IP	Note
V 215 F05-PST	02215612	120	80	55	65	Euromas-Vestamid-Gehäuse mit F05-Aufnahme, mit PST-Ausschnitt
V 215 F05-FG-PST	02215622	120	80	55	65	Euromas-Vestamid-Gehäuse mit F05-Aufnahme, mit PST-Ausschnitt und Sichtfenster
V 215 F05-ZR	02215613	120	80	55	65	Euromas-Vestamid-Gehäuse mit F05-Aufnahme, mit Zentrierung
V 215 F05-FG-ZR	02215623	120	80	55	65	Euromas-Vestamid-Gehäuse mit F05-Aufnahme, mit Zentrierung und Sichtfenster



Scope Of Delivery:

Unterteil, Oberteil

Notes: Pg 13 Steckverschraubung für PST-Ausschnitt bitte separat bestellen (Bestell-Nr.: 12060407). Ausführung mit glasklarem Deckel (PC) sowie in Gehäusematerial PC-Lichtgrau, ähnlich RAL 7035, auf Anfrage lieferbar.

Achtung: Da die Montage der Stellachse inkl. der Stellachsendichtung erst bei der Komplettbestückung des Gerätes erfolgt, ist der Hersteller des Komplettgerätes für die Einhaltung der Schutzart IP 65 nach DIN EN 60529 für diese Dichtstelle verantwortlich! Eine Gewährleistung hierfür kann durch den Gehäusehersteller nicht übernommen werden.

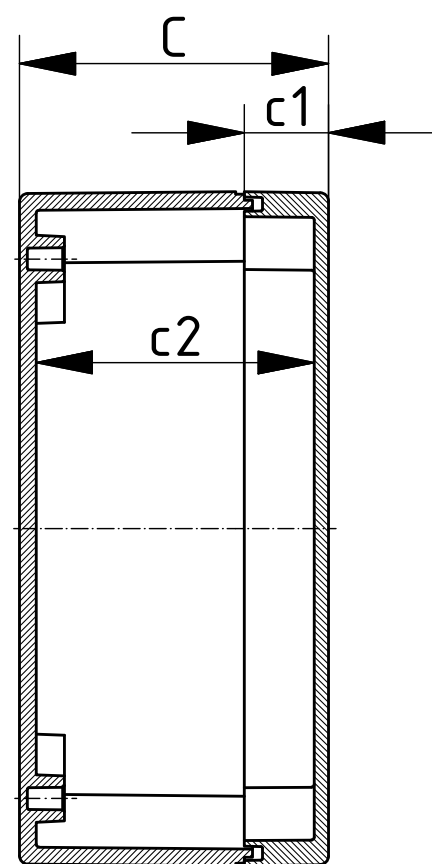
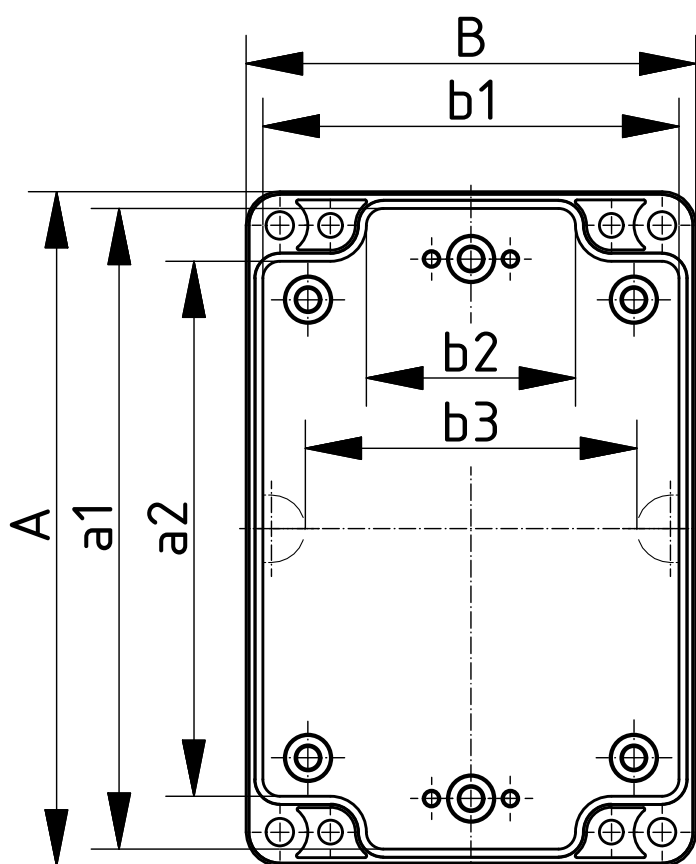

Z-2503224

Euromas ABS / PC / F05 Montageplatten



Montageplatten, Hartpapier, Stahl verzinkt bei Modell 260

Model	Order no.	Note
M M 205 EM/ET 205	22000100	Für EM/ET 205, M/T 205
M M 206 EM/ET 206	22000200	Für EM/ET 206, M/T 206
M M 210/225	22000300	Für EM/ET 210, EM/ET 225, M/T 210, M/T 225
M M 215/216/226/230	22000400	Für EM/ET 215, M/T 215-216, M/T 226, M/T 230
M M 217/227/228	22000500	Für EM/ET 217, EM/ET 227, M/T 217, M/T 227-228
M M/T 219/220/231/235	22000600	Für EM/ET 220, EM/ET 231, M/T 219-220, M/T 231-235
M M 221/237	22000700	Für EM/ET 221, EM/ET 237, M/T 221, M/T 237
M M 223	22000800	Für EM/ET 223, M/T 223
M M 239/240/241/250	22000900	Für EM/ET 239-241, M/T 240, M/T 241, M/T 250
M M 2401/243	22001000	Für M/T 2401, M/T 243
M	22001100	Für EM/ET 238, M/T 238, M/T 2381, M/T 246
M M 242	22001200	Für EM/ET 242, M/T 242
M M 244/245	22001300	Für M/T 244-245
M M 251	22001400	Für M/T 251
M M 252/253/254	22001500	Für M/T 252-254
M M 255	22001600	Für M/T 255
M M 260	22001610	Für T 260

Scope Of Delivery:

1 Montageplatte

Euromas ABS / PC / F05

Zubehör

Mastbefestigung, Edelstahl V2A, unbeschichtet

Model	Order no.
MH 080	96500080
MH 122	96500122
MH 167	96500167
MH 220	96500220
MH 265	96500265

Scope Of Delivery:

MH: 1 Satz (2 Stück)

BFS: 20 Stück

Notes: Befestigungssatz bitte gemäß Tabelle (siehe "Produktinformationen") separat bestellen.

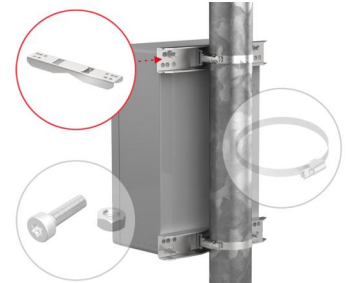

Befestigungssatz für Mastbefestigung

Model	Order no.	Note
BFS MH 1	96500001	Befestigungssatz
BFS MH 2	96500002	Befestigungssatz
BFS MH 3	96500003	Befestigungssatz

Scope Of Delivery:

20 Stück (für 5 Satz Mastbefestigungen)

Notes: Die passende Mastbefestigung je Gehäusegröße sowie den dazugehörigen Befestigungssatz bitte aus der Tabelle (siehe „Produktinformationen“) entnehmen.

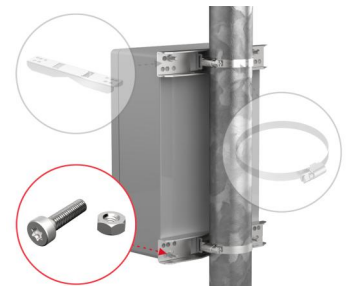

Schelle für Mastbefestigung, Edelstahl

Model	Order no.	Note
MH S 32-50	96500050	Klemmbereich 32-50 mm
MH S 50-70	96500070	Klemmbereich 50-70 mm
MH S 70-90	96500090	Klemmbereich 70-90 mm
MH S 90-110	96500110	Klemmbereich 90-110 mm
MH S 110-130	96500130	Klemmbereich 110-130 mm
MH S 130-150	96500150	Klemmbereich 130-150 mm
MH S 150-170	96500175	Klemmbereich 150-170 mm
MH S 170-190	96500190	Klemmbereich 170-190 mm
MH S 190-210	96500210	Klemmbereich 190-210 mm

Scope Of Delivery:

10 Stück



Verbindungs der Mastbefestigung für Euromas ABS / PC
Use of the Mast Mounting for Euromas ABS / PC

Bitte wählen Sie anhand dieser Tabelle je nach Größe und Ausrichtung des Gehäuses die passende Mastbefestigung und den dazugehörigen Befestigungssatz aus.

Please use this table to select the appropriate mast mounting and the associated mounting kit depending on the size and alignment of the enclosure.

Abgleichung des Gehäuses / Alignment of the enclosure:
H = horizontal, V = vertical

Gehäuse	Mastbefestigung	Befestigungssatz	H = horizontal
Order no.	Mastbefestigung	Befestigungssatz	
MH 080 H	MH 080	BFS MH 1	
MH 080 V	MH 080	BFS MH 1	
MH 122 H	MH 122	BFS MH 1	
MH 122 V	MH 122	BFS MH 1	
MH 167 H	MH 167	BFS MH 1	
MH 167 V	MH 167	BFS MH 1	
MH 220 H	MH 220	BFS MH 1	
MH 220 V	MH 220	BFS MH 1	
MH 265 H	MH 265	BFS MH 1	
MH 265 V	MH 265	BFS MH 1	
MH 080 H	MH 080	BFS MH 1	
MH 080 V	MH 080	BFS MH 1	
MH 122 H	MH 122	BFS MH 1	
MH 122 V	MH 122	BFS MH 1	
MH 167 H	MH 167	BFS MH 1	
MH 167 V	MH 167	BFS MH 1	
MH 220 H	MH 220	BFS MH 1	
MH 220 V	MH 220	BFS MH 1	
MH 265 H	MH 265	BFS MH 1	
MH 265 V	MH 265	BFS MH 1	
MH 080 H	MH 080	BFS MH 1	
MH 080 V	MH 080	BFS MH 1	
MH 122 H	MH 122	BFS MH 1	
MH 122 V	MH 122	BFS MH 1	
MH 167 H	MH 167	BFS MH 1	
MH 167 V	MH 167	BFS MH 1	
MH 220 H	MH 220	BFS MH 1	
MH 220 V	MH 220	BFS MH 1	
MH 265 H	MH 265	BFS MH 1	
MH 265 V	MH 265	BFS MH 1	
MH 080 H	MH 080	BFS MH 1	
MH 080 V	MH 080	BFS MH 1	
MH 122 H	MH 122	BFS MH 1	
MH 122 V	MH 122	BFS MH 1	
MH 167 H	MH 167	BFS MH 1	
MH 167 V	MH 167	BFS MH 1	
MH 220 H	MH 220	BFS MH 1	
MH 220 V	MH 220	BFS MH 1	
MH 265 H	MH 265	BFS MH 1	
MH 265 V	MH 265	BFS MH 1	
MH 080 H	MH 080	BFS MH 1	
MH 080 V	MH 080	BFS MH 1	
MH 122 H	MH 122	BFS MH 1	
MH 122 V	MH 122	BFS MH 1	
MH 167 H	MH 167	BFS MH 1	
MH 167 V	MH 167	BFS MH 1	
MH 220 H	MH 220	BFS MH 1	
MH 220 V	MH 220	BFS MH 1	
MH 265 H	MH 265	BFS MH 1	
MH 265 V	MH 265	BFS MH 1	

Revised: 03.02.2021

Euromas ABS / PC / F05

Zubehör



Wandlaschen rückseitig anschraubbar, Polycarbonat

Model	Order no.	Note
WL	22004900	Für M/T 210-243, M/T 246-253

Scope Of Delivery:
4 Stück



Tragschienen DIN EN 60715 TH 15, Stahl verzinkt

Model	Order no.	Note
TS 15	22001800	Für M/T 205
TS 15	22001710	Für M/T 206
TS 15	22001700	Für M/T 210, M/T 225
TS 15	22001900	Für M/T 215-217, M/T 226-230
TS 15	22002000	Für M/T 219-220, M/T 231-235, M/T 238, M/T 2381, M/T 246, P 325
TS 15	22002100	Für M/T 221-223, M/T 237
TS 15	22002402	Für M/T 240-243, M/T 2401, M/T 250
TS 15	22002720	Für M/T 244-245
TS 15	22002820	Für M/T 251
TS 15	22002920	Für M/T 252-254

Scope Of Delivery:
1 Tragschiene

Notes: Befestigungsschrauben im Allgemeinen Zubehör. C = Länge der Tragschiene in mm. Passende Klemmen und Klemmenmontage auf Anfrage.



Tragschienen DIN EN 60715 G 32, Stahl verzinkt

Model	Order no.	Note
TS 32	22001701	Für M/T 210, M/T 225, P 305, P 326
TS 32	22002010	Für M/T 219-220, M/T 231-235, M/T 238, M/T 2381, M/T 246, P 316, P 325
TS 32	22002110	Für M/T 221-223, M/T 237
TS 32	22002300	Für M/T 240, M/T 241, M/T 250
TS 32	22002400	Für M/T 2401, M/T 242-243
TS 32	22002700	Für M/T 244-245
TS 32	22002800	Für M/T 251
TS 32	22002900	Für M/T 252-254
TS 32	22002950	Für M/T 255
TS 32	22002960	Für T 260

Scope Of Delivery:
1 Tragschiene

Notes: Befestigungsschrauben im Allgemeinen Zubehör. C = Länge der Tragschiene in mm. Passende Klemmen und Klemmenmontage auf Anfrage.

Euromas ABS / PC / F05

Zubehör

Tragschienen DIN EN 60715 TH 35, Stahl verzinkt

Model	Order no.	Note
TS 35	22001702	Für M/T 210, M/T 225, P 305, P 326
TS 35	22001910	Für M/T 215-217, M/T 226-230
TS 35	22002020	Für M/T 219-220, M/T 231-235, M/T 238, M/T 2381, M/T 246, P 316, P 325
TS 35	22002115	Für M/T 221-223, M/T 237
TS 35	22002310	Für M/T 240, M/T 241, M/T 250
TS 35	22002401	Für M/T 2401, M/T 242-243
TS 35	22002710	Für M/T 244-245
TS 35	22002810	Für M/T 251
TS 35	22002910	Für M/T 252, 253, 254
TS 35	22002951	Für M/T 255

Scope Of Delivery:

1 Tragschiene

Notes: Befestigungsschrauben im Allgemeinen Zubehör. C = Länge der Tragschiene in mm. Passende Klemmen und Klemmenmontage auf Anfrage.



Scharniersatz

Model	Order no.
SchM	22006000

Scope Of Delivery:

1 Scharniersatz (Polycarbonat)

Notes: Einsetzbar ab einer Deckelhöhe von 15 mm. Mechanische Bearbeitung und Montage auf Anfrage.



Gewindebuchsen für Montagenocken

Model	Order no.	Note
DODGE M3x6,5	59002810	ND = 4,0 x 6,5
DODGE M4x9,5	59002820	ND = 5,4 x 9,5

Scope Of Delivery:

1 Stück

Notes: Buchse bei der Montage bis auf den Boden in die Nocke einstecken, danach ist die Spreitzplatte mittels eines Stiftes niederzuschlagen.



GummifüÙe, einsteckbar

Model	Order no.	Note
F	22003300	Für M/T 208-260

Scope Of Delivery:

4 Stück



Euromas ABS / PC / F05

Zubehör



Rändelschrauben

Model	Order no.	Note
RD	22003100	Für M/T 210-215, M/T 217, M/T 220-227, M/T 231
RD	22003200	Für M/T 240-2401
RD	22003310	Für M/T 241, M/T 2381, M/T 243

Scope Of Delivery:

1 Satz, passend für ein Gehäuse

Notes: Nicht bei den Gehäusen mit Schnellverschluss einsetzbar.



BOPLA

A Phoenix Mecano Company