

# ESD7361, SZESD7361

## ESD Protection Diode

### Low Capacitance ESD Protection Diode for High Speed Data Line

The ESD7361 Series ESD protection diodes are designed to protect high speed data lines from ESD. Ultra-low capacitance make this device an ideal solution for protecting voltage sensitive high speed data lines.

#### Features

- Low Capacitance (0.55 pF Max, I/O to GND)
- Protection for the Following IEC Standards:
  - ♦ IEC61000-4-2 (ESD): Level 4 ±15 kV Contact
  - ♦ IEC61000-4-4 (EFT): 40 A -5/50 ns
  - ♦ IEC61000-4-5 (Lightning): 1 A (8/20 μs)
- ISO 10605 (ESD) 330 pF/2 kΩ ±15 kV Contact
- SZ Prefix for Automotive and Other Applications Requiring Unique Site and Control Change Requirements; AEC-Q101 Qualified and PPAP Capable
- These Devices are Pb-Free, Halogen Free/BFR Free and are RoHS Compliant

#### Typical Applications

- Wireless Charger
- Near Field Communications

#### MAXIMUM RATINGS (T<sub>J</sub> = 25°C unless otherwise noted)

Rating	Symbol	Value	Unit
Operating Junction Temperature Range	T <sub>J</sub>	-55 to +125	°C
Storage Temperature Range	T <sub>stg</sub>	-55 to +150	°C
Lead Solder Temperature – Maximum (10 Seconds)	T <sub>L</sub>	260	°C
IEC 61000-4-2 Contact (ESD)	ESD	±15	kV
IEC 61000-4-2 Air (ESD)	ESD	±15	kV
ISO 10605 330 pF/2 kΩ Contact (ESD)	ESD	±15	kV

Stresses exceeding those listed in the Maximum Ratings table may damage the device. If any of these limits are exceeded, device functionality should not be assumed, damage may occur and reliability may be affected.



ON Semiconductor®

[www.onsemi.com](http://www.onsemi.com)

#### MARKING DIAGRAMS

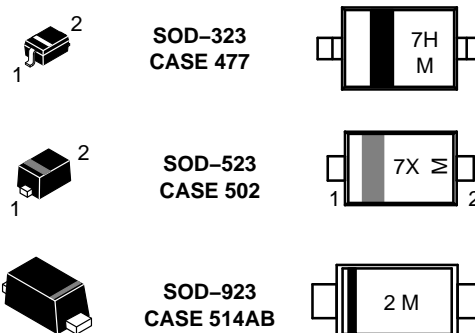

X, XX = Specific Device Code  
M = Date Code

#### PIN CONFIGURATION AND SCHEMATIC

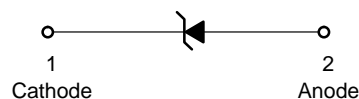

#### ORDERING INFORMATION

See detailed ordering and shipping information on page 6 of this data sheet.

# ESD7361, SZESD7361

## ELECTRICAL CHARACTERISTICS

( $T_A = 25^\circ\text{C}$  unless otherwise noted)

Symbol	Parameter
$I_{PP}$	Maximum Reverse Peak Pulse Current
$V_C$	Clamping Voltage @ $I_{PP}$
$V_{RWM}$	Working Peak Reverse Voltage
$I_R$	Maximum Reverse Leakage Current @ $V_{RWM}$
$V_{BR}$	Breakdown Voltage @ $I_T$
$I_T$	Test Current

\*See Application Note AND8308/D for detailed explanations of datasheet parameters.

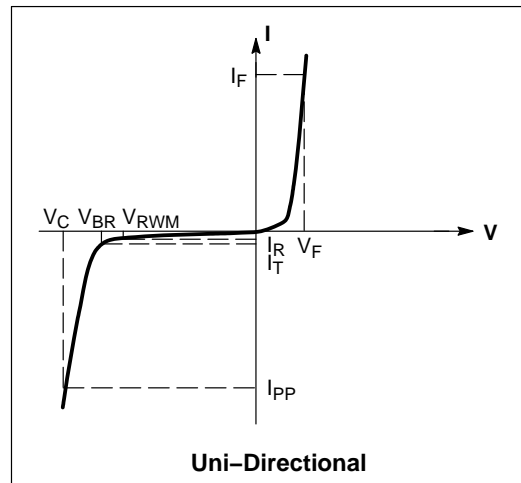

## ELECTRICAL CHARACTERISTICS ( $T_A = 25^\circ\text{C}$ unless otherwise specified)

Parameter	Symbol	Conditions	Min	Typ	Max	Unit
Reverse Working Voltage	$V_{RWM}$			5	16	V
Breakdown Voltage	$V_{BR}$	$I_T = 1 \text{ mA}$ ; pin 1 to pin 2	16.5			V
Reverse Leakage Current	$I_R$	$V_{RWM} = 5.0 \text{ V}$ $V_{RWM} = 15 \text{ V}$		<1 20	1000 1000	nA nA
Clamping Voltage (Note 2)	$V_C$	$I_{PP} = 8 \text{ A}$		31		V
Clamping Voltage (Note 2)	$V_C$	$I_{PP} = 16 \text{ A}$		34		V
Junction Capacitance	$C_J$	$V_R = 0 \text{ V}$ , $f = 1 \text{ MHz}$ $V_R = 0 \text{ V}$ , $f < 1 \text{ GHz}$			0.55 0.55	pF
Dynamic Resistance	$R_{DYN}$	TLP Pulse		0.735		$\Omega$
Insertion Loss		$f = 1 \text{ MHz}$ $f = 5 \text{ GHz}$		0.01 2		dB

Product parametric performance is indicated in the Electrical Characteristics for the listed test conditions, unless otherwise noted. Product performance may not be indicated by the Electrical Characteristics if operated under different conditions.

- For test procedure see Figures 9 and 10 and application note AND8307/D.
- ANSI/ESD STM5.5.1 – Electrostatic Discharge Sensitivity Testing using Transmission Line Pulse (TLP) Model.  
TLP conditions:  $Z_0 = 50 \Omega$ ,  $t_p = 100 \text{ ns}$ ,  $t_r = 4 \text{ ns}$ , averaging window;  $t_1 = 30 \text{ ns}$  to  $t_2 = 60 \text{ ns}$ .

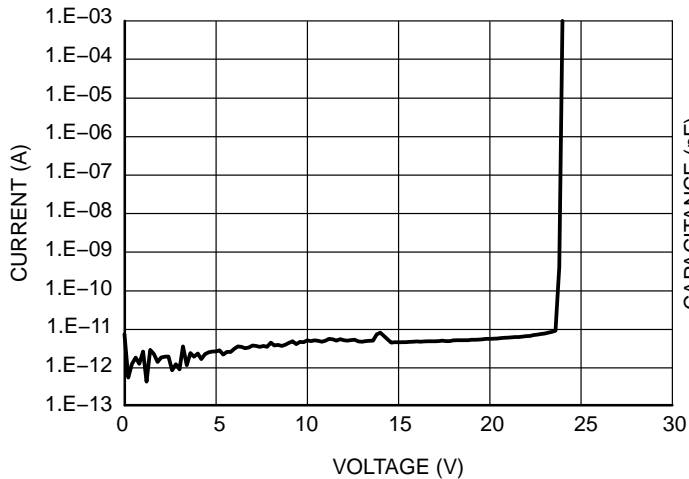

Figure 1. Typical IV Characteristics

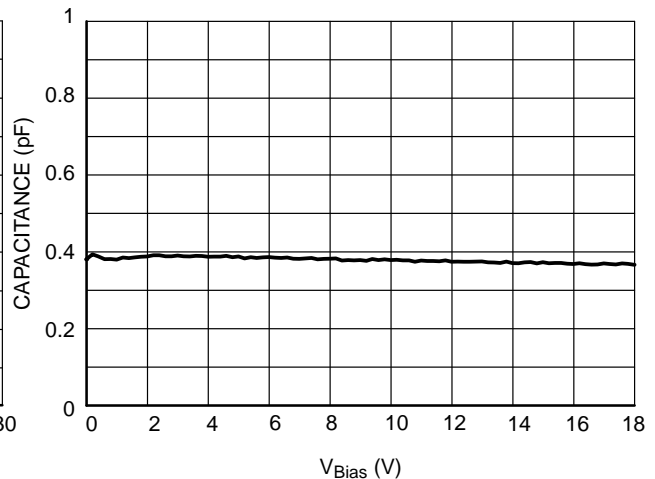
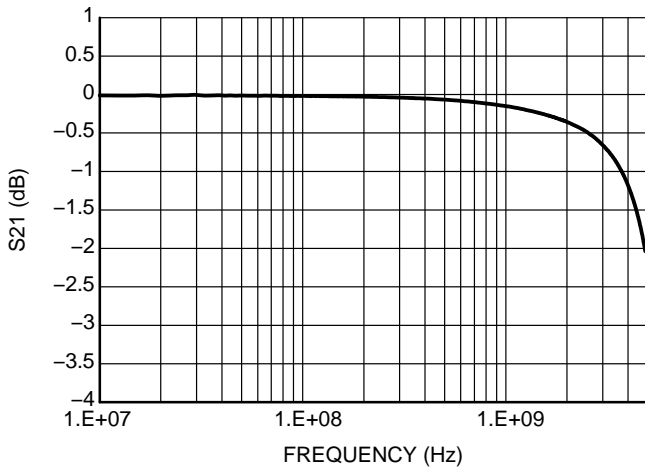
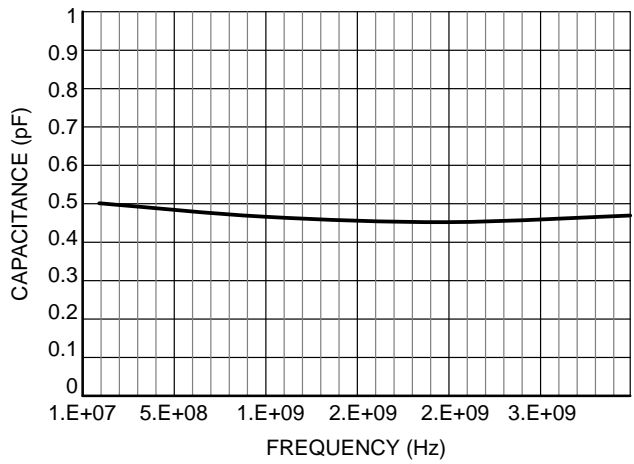

Figure 2. Typical CV Characteristics

# ESD7361, SZESD7361



**Figure 3. Typical Insertion Loss  
ESD7361HT1G (SOD323)**



**Figure 4. Typical Capacitance Over Frequency  
ESD7361HT1G (SOD323)**

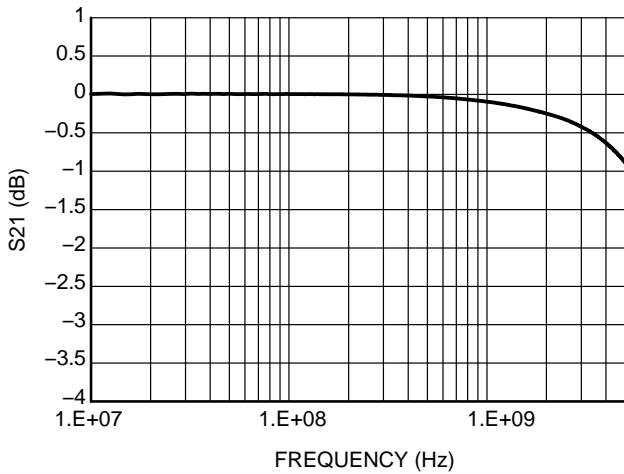

**Figure 5. Typical Insertion Loss  
ESD7361XV2T1G (SOD523)**

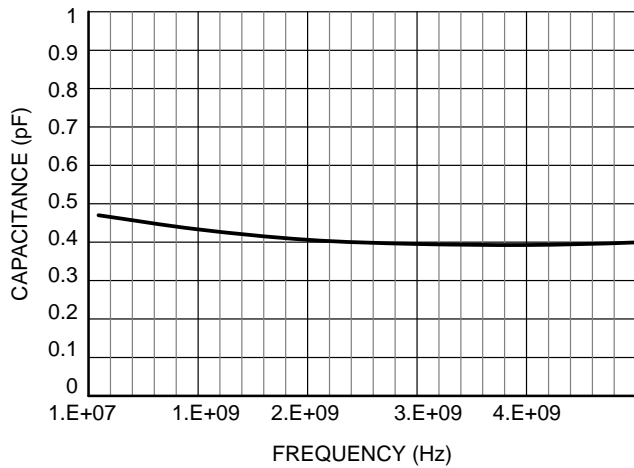

**Figure 6. Typical Capacitance Over Frequency  
ESD7361XV2T1G (SOD523)**

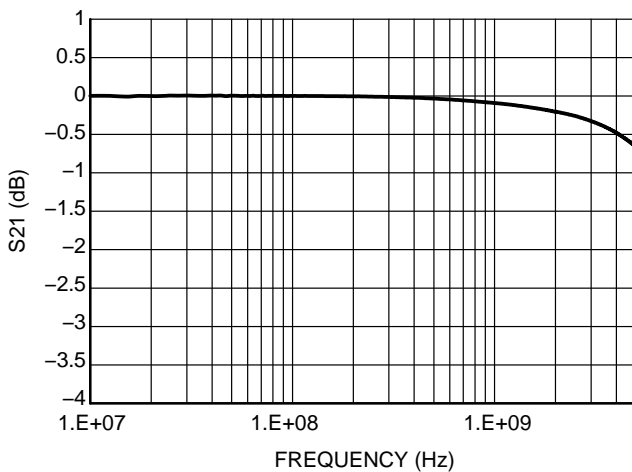

**Figure 7. Typical Insertion Loss  
ESD7361P2T5G (SOD923)**

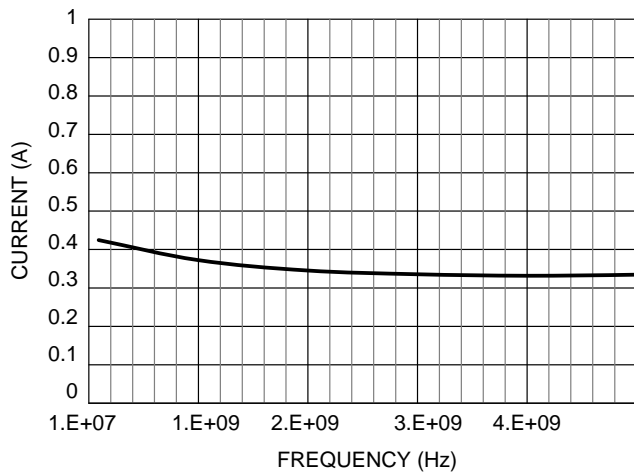

**Figure 8. Typical Capacitance Over Frequency  
ESD7361P2T5G (SOD923)**

# ESD7361, SZESD7361

## IEC 61000-4-2 Spec.

Level	Test Voltage (kV)	First Peak Current (A)	Current at 30 ns (A)	Current at 60 ns (A)
1	2	7.5	4	2
2	4	15	8	4
3	6	22.5	12	6
4	8	30	16	8

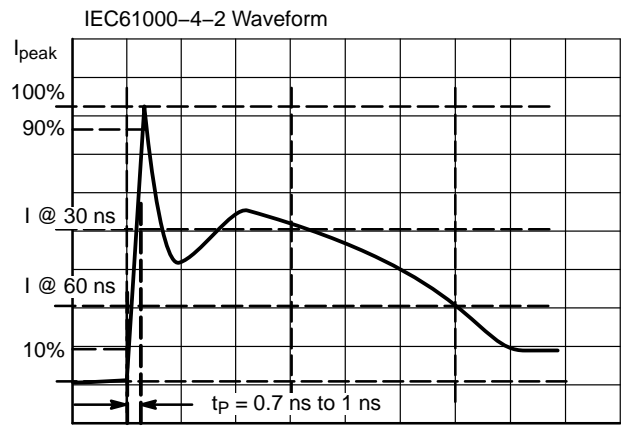

Figure 9. IEC61000-4-2 Spec

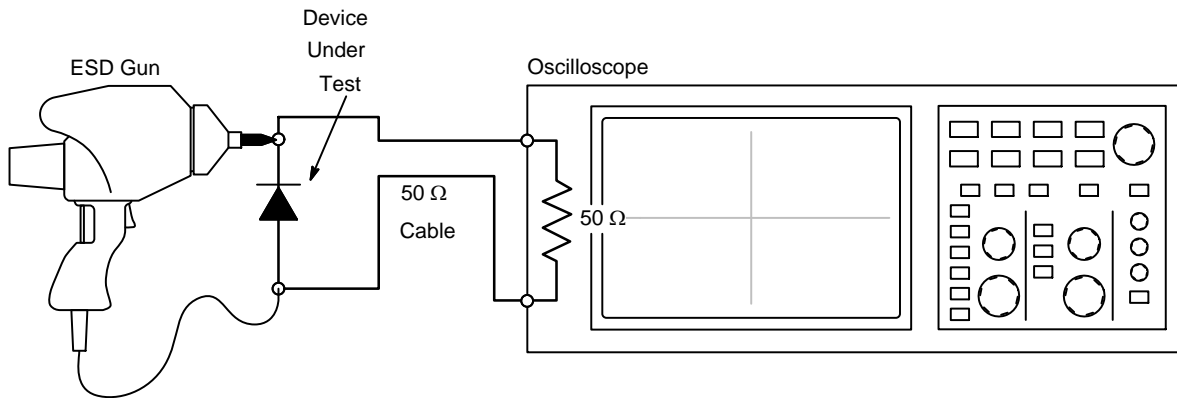

Figure 10. Diagram of ESD Clamping Voltage Test Setup

The following is taken from Application Note AND8308/D – Interpretation of Datasheet Parameters for ESD Devices.

### ESD Voltage Clamping

For sensitive circuit elements it is important to limit the voltage that an IC will be exposed to during an ESD event to as low a voltage as possible. The ESD clamping voltage is the voltage drop across the ESD protection diode during an ESD event per the IEC61000-4-2 waveform. Since the IEC61000-4-2 was written as a pass/fail spec for larger

systems such as cell phones or laptop computers it is not clearly defined in the spec how to specify a clamping voltage at the device level. ON Semiconductor has developed a way to examine the entire voltage waveform across the ESD protection diode over the time domain of an ESD pulse in the form of an oscilloscope screenshot, which can be found on the datasheets for all ESD protection diodes. For more information on how ON Semiconductor creates these screenshots and how to interpret them please refer to AND8307/D.

## ESD7361, SZESD7361

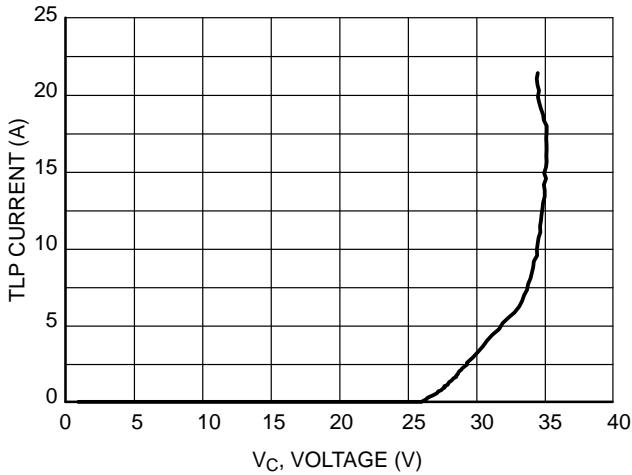

**Figure 11. Positive TLP I-V Curve**

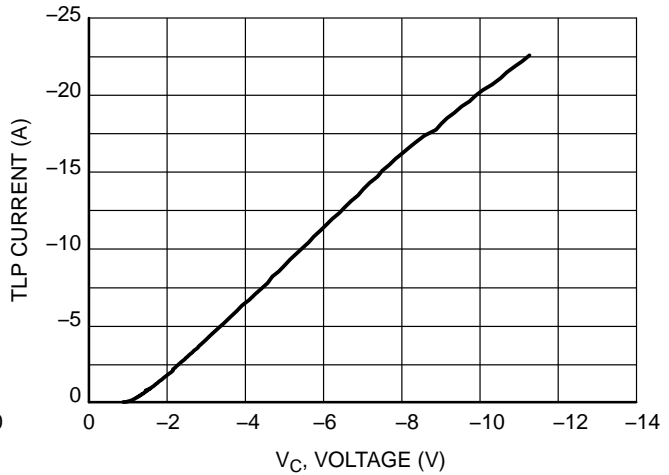
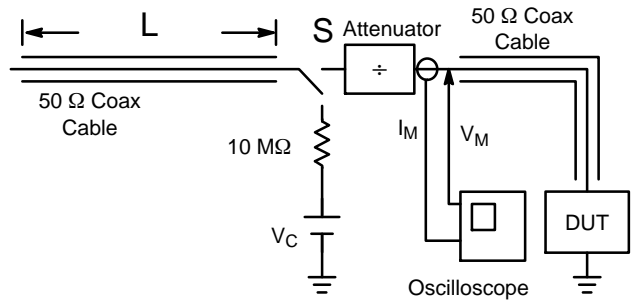

**Figure 12. Negative TLP I-V Curve**

NOTE: TLP parameter:  $Z_0 = 50 \Omega$ ,  $t_p = 100 \text{ ns}$ ,  $t_r = 300 \text{ ps}$ , averaging window:  $t_1 = 30 \text{ ns}$  to  $t_2 = 60 \text{ ns}$ .  $V_{IEC}$  is the equivalent voltage stress level calculated at the secondary peak of the IEC 61000-4-2 waveform at  $t = 30 \text{ ns}$  with  $2 \text{ A/kV}$ . See TLP description below for more information.

### Transmission Line Pulse (TLP) Measurement

Transmission Line Pulse (TLP) provides current versus voltage (I-V) curves in which each data point is obtained from a 100 ns long rectangular pulse from a charged transmission line. A simplified schematic of a typical TLP system is shown in Figure 13. TLP I-V curves of ESD protection devices accurately demonstrate the product's ESD capability because the 10s of amps current levels and under 100 ns time scale match those of an ESD event. This is illustrated in Figure 14 where an 8 kV IEC 61000-4-2 current waveform is compared with TLP current pulses at 8 A and 16 A. A TLP I-V curve shows the voltage at which the device turns on as well as how well the device clamps voltage over a range of current levels.



**Figure 13. Simplified Schematic of a Typical TLP System**

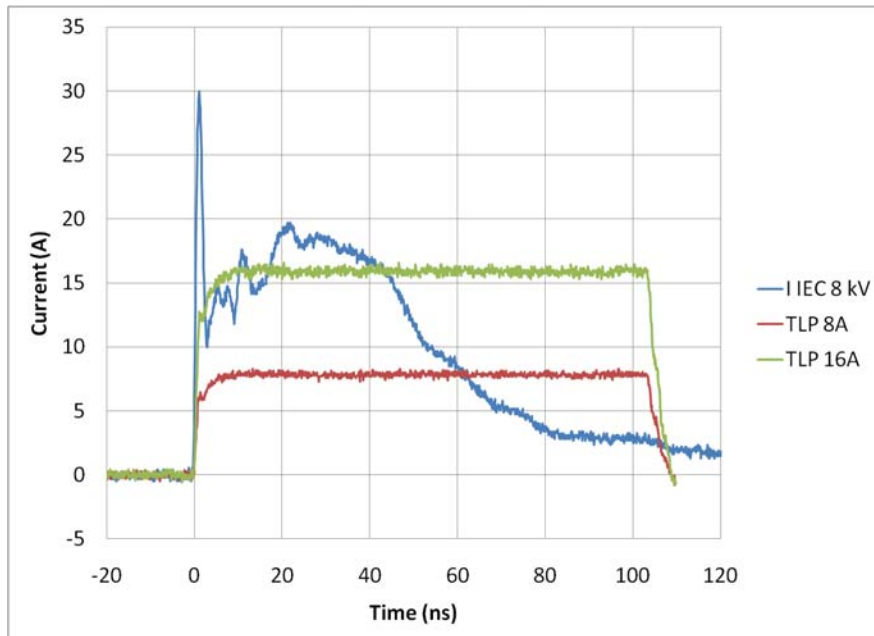

**Figure 14. Comparison Between 8 kV IEC 61000-4-2 and 8 A and 16 A TLP Waveforms**

# ESD7361, SZESD7361

## ORDERING INFORMATION

Device	Package	Shipping†
ESD7361HT1G	SOD-323 (Pb-Free)	3000 / Tape & Reel
SZESD7361HT1G*		
ESD7361XV2T1G	SOD-523 (Pb-Free)	3000 / Tape & Reel
SZESD7361XV2T1G*		
ESD7361XV2T5G		8000 / Tape & Reel
SZESD7361XV2T5G*		
ESD7361P2T5G	SOD-923 (Pb-Free)	8000 / Tape & Reel
SZESD7361P2T5G*		

†For information on tape and reel specifications, including part orientation and tape sizes, please refer to our Tape and Reel Packaging Specifications Brochure, BRD8011/D.

\*SZ Prefix for Automotive and Other Applications Requiring Unique Site and Control Change Requirements; AEC-Q101 Qualified and PPAP Capable.

# MECHANICAL CASE OUTLINE

## PACKAGE DIMENSIONS

ON Semiconductor®



**SOD-323**  
CASE 477-02  
ISSUE H

DATE 13 MAR 2007

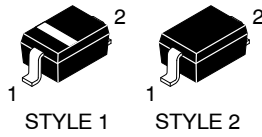

SCALE 4:1

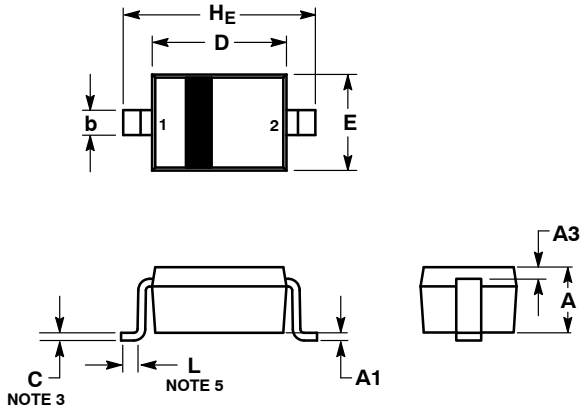

**NOTES:**

1. DIMENSIONING AND TOLERANCING PER ANSI Y14.5M, 1982.
2. CONTROLLING DIMENSION: MILLIMETERS.
3. LEAD THICKNESS SPECIFIED PER L/F DRAWING WITH SOLDER PLATING.
4. DIMENSIONS A AND B DO NOT INCLUDE MOLD FLASH, PROTRUSIONS OR GATE BURRS.
5. DIMENSION L IS MEASURED FROM END OF RADIUS.

DIM	MILLIMETERS			INCHES		
	MIN	NOM	MAX	MIN	NOM	MAX
A	0.80	0.90	1.00	0.031	0.035	0.040
A1	0.00	0.05	0.10	0.000	0.002	0.004
A3	0.15 REF			0.006 REF		
b	0.25	0.32	0.4	0.010	0.012	0.016
C	0.089	0.12	0.177	0.003	0.005	0.007
D	1.60	1.70	1.80	0.062	0.066	0.070
E	1.15	1.25	1.35	0.045	0.049	0.053
L	0.08			0.003		
HE	2.30	2.50	2.70	0.090	0.098	0.105

**GENERIC MARKING DIAGRAM\***

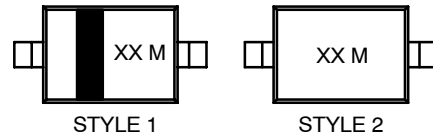

XX = Specific Device Code  
M = Date Code

\*This information is generic. Please refer to device data sheet for actual part marking. Pb-Free indicator, "G" or microdot "▪", may or may not be present.

**SOLDERING FOOTPRINT\***

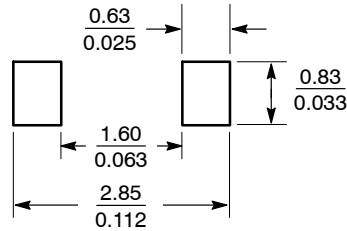

\*For additional information on our Pb-Free strategy and soldering details, please download the ON Semiconductor Soldering and Mounting Techniques Reference Manual, SOLDERRM/D.

STYLE 1:  
PIN 1. CATHODE (POLARITY BAND)  
2. ANODE

STYLE 2:  
NO POLARITY

<b>DOCUMENT NUMBER:</b>	<b>98ASB17533C</b>	Electronic versions are uncontrolled except when accessed directly from the Document Repository. Printed versions are uncontrolled except when stamped "CONTROLLED COPY" in red.
<b>DESCRIPTION:</b>	<b>SOD-323</b>	<b>PAGE 1 OF 1</b>

ON Semiconductor and are trademarks of Semiconductor Components Industries, LLC dba ON Semiconductor or its subsidiaries in the United States and/or other countries. ON Semiconductor reserves the right to make changes without further notice to any products herein. ON Semiconductor makes no warranty, representation or guarantee regarding the suitability of its products for any particular purpose, nor does ON Semiconductor assume any liability arising out of the application or use of any product or circuit, and specifically disclaims any and all liability, including without limitation special, consequential or incidental damages. ON Semiconductor does not convey any license under its patent rights nor the rights of others.

# MECHANICAL CASE OUTLINE

## PACKAGE DIMENSIONS

ON Semiconductor®

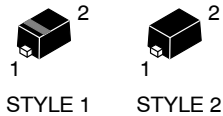

**SOD-523**  
CASE 502-01  
ISSUE E

DATE 28 SEP 2010

SCALE 4:1

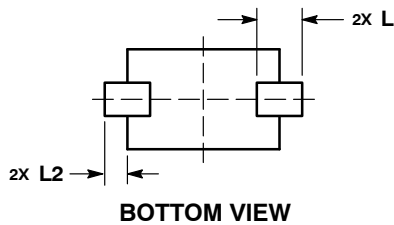
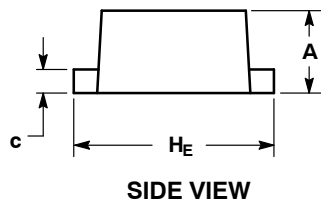
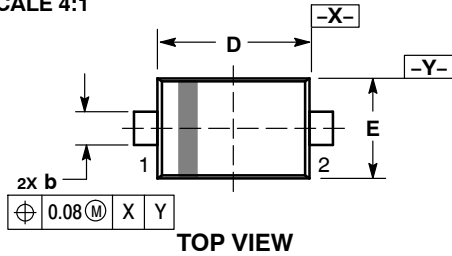

### RECOMMENDED SOLDERING FOOTPRINT\*

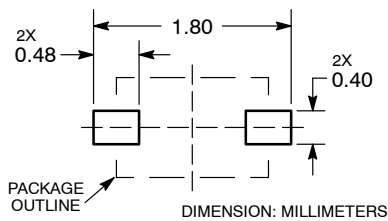

- NOTES:
1. DIMENSIONING AND TOLERANCING PER ASME Y14.5M, 1994.
  2. CONTROLLING DIMENSION: MILLIMETERS.
  3. MAXIMUM LEAD THICKNESS INCLUDES LEAD FINISH. MINIMUM LEAD THICKNESS IS THE MINIMUM THICKNESS OF BASE MATERIAL.
  4. DIMENSIONS D AND E DO NOT INCLUDE MOLD FLASH, PROTRUSIONS, OR GATE BURRS.

DIM	MILLIMETERS		
	MIN	NOM	MAX
A	0.50	0.60	0.70
b	0.25	0.30	0.35
c	0.07	0.14	0.20
D	1.10	1.20	1.30
E	0.70	0.80	0.90
H <sub>E</sub>	1.50	1.60	1.70
L	0.30 REF		
L2	0.15	0.20	0.25

### GENERIC MARKING DIAGRAM\*

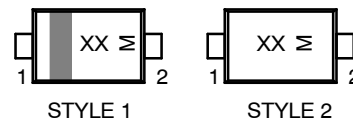

XX = Specific Device Code  
M = Date Code

\*This information is generic. Please refer to device data sheet for actual part marking. Pb-Free indicator, "G" or microdot "▪", may or may not be present.

STYLE 1: PIN 1. CATHODE (POLARITY BAND) 2. ANODE  
STYLE 2: NO POLARITY

\*For additional information on our Pb-Free strategy and soldering details, please download the ON Semiconductor Soldering and Mounting Techniques Reference Manual, SOLDERRM/D.

<b>DOCUMENT NUMBER:</b>	<b>98AON11524D</b>	Electronic versions are uncontrolled except when accessed directly from the Document Repository. Printed versions are uncontrolled except when stamped "CONTROLLED COPY" in red.
<b>DESCRIPTION:</b>	<b>SOD-523</b>	<b>PAGE 1 OF 1</b>

ON Semiconductor and are trademarks of Semiconductor Components Industries, LLC dba ON Semiconductor or its subsidiaries in the United States and/or other countries. ON Semiconductor reserves the right to make changes without further notice to any products herein. ON Semiconductor makes no warranty, representation or guarantee regarding the suitability of its products for any particular purpose, nor does ON Semiconductor assume any liability arising out of the application or use of any product or circuit, and specifically disclaims any and all liability, including without limitation special, consequential or incidental damages. ON Semiconductor does not convey any license under its patent rights nor the rights of others.



# MECHANICAL CASE OUTLINE PACKAGE DIMENSIONS

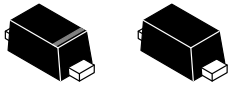

STYLE 1      STYLE 2

SCALE 8:1

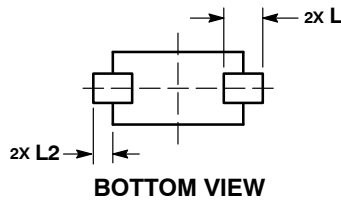
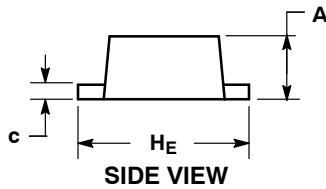
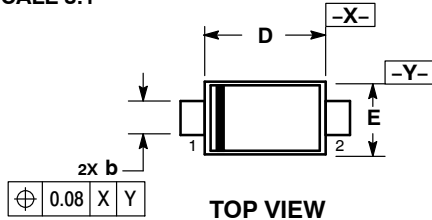

**SOLDERING FOOTPRINT\***

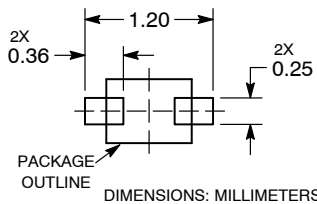

**SOD-923  
CASE 514AB  
ISSUE D**

DATE 03 SEP 2020

NOTES:

1. DIMENSIONING AND TOLERANCING PER ASME Y14.5M, 1994.
2. CONTROLLING DIMENSION: MILLIMETERS.
3. MAXIMUM LEAD THICKNESS INCLUDES LEAD FINISH. MINIMUM LEAD THICKNESS IS THE MINIMUM THICKNESS OF BASE MATERIAL.
4. DIMENSIONS D AND E DO NOT INCLUDE MOLD FLASH, PROTRUSIONS, OR GATE BURRS.
5. DIMENSION L WILL NOT EXCEED 0.30mm.

DIM	MILLIMETERS			INCHES		
	MIN	NOM	MAX	MIN	NOM	MAX
A	0.34	0.37	0.40	0.013	0.015	0.016
b	0.15	0.20	0.25	0.006	0.008	0.010
c	0.07	0.12	0.17	0.003	0.005	0.007
D	0.75	0.80	0.85	0.030	0.031	0.033
E	0.55	0.60	0.65	0.022	0.024	0.026
HE	0.95	1.00	1.05	0.037	0.039	0.041
L	0.19 REF			0.007 REF		
L2	0.05	0.10	0.15	0.002	0.004	0.006

**GENERIC  
MARKING DIAGRAM\***

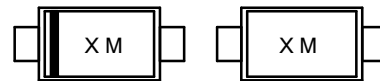

STYLE 1

STYLE 2

X = Specific Device Code  
M = Date Code

\*This information is generic. Please refer to device data sheet for actual part marking. Pb-Free indicator, "G" or microdot "▪", may or may not be present. Some products may not follow the Generic Marking.

STYLE 1:  
PIN 1. CATHODE (POLARITY BAND)  
2. ANODE

STYLE 2:  
NO POLARITY

See Application Note AND8455/D for more mounting details

\*For additional information on our Pb-Free strategy and soldering details, please download the **onsemi** Soldering and Mounting Techniques Reference Manual, SOLDERRM/D.

<b>DOCUMENT NUMBER:</b>	<b>98AON23284D</b>	Electronic versions are uncontrolled except when accessed directly from the Document Repository. Printed versions are uncontrolled except when stamped "CONTROLLED COPY" in red.
<b>DESCRIPTION:</b>	<b>SOD-923, 1.0x0.6x0.37, MAX HEIGHT 0.40</b>	<b>PAGE 1 OF 1</b>

onsemi and ONSEMI are trademarks of Semiconductor Components Industries, LLC dba onsemi or its subsidiaries in the United States and/or other countries. onsemi reserves the right to make changes without further notice to any products herein. onsemi makes no warranty, representation or guarantee regarding the suitability of its products for any particular purpose, nor does onsemi assume any liability arising out of the application or use of any product or circuit, and specifically disclaims any and all liability, including without limitation special, consequential or incidental damages. onsemi does not convey any license under its patent rights nor the rights of others.

**onsemi**, **Onsemi**, and other names, marks, and brands are registered and/or common law trademarks of Semiconductor Components Industries, LLC dba "**onsemi**" or its affiliates and/or subsidiaries in the United States and/or other countries. **onsemi** owns the rights to a number of patents, trademarks, copyrights, trade secrets, and other intellectual property. A listing of **onsemi**'s product/patent coverage may be accessed at [www.onsemi.com/site/pdf/Patent-Marking.pdf](http://www.onsemi.com/site/pdf/Patent-Marking.pdf). **onsemi** reserves the right to make changes at any time to any products or information herein, without notice. The information herein is provided "as-is" and **onsemi** makes no warranty, representation or guarantee regarding the accuracy of the information, product features, availability, functionality, or suitability of its products for any particular purpose, nor does **onsemi** assume any liability arising out of the application or use of any product or circuit, and specifically disclaims any and all liability, including without limitation special, consequential or incidental damages. Buyer is responsible for its products and applications using **onsemi** products, including compliance with all laws, regulations and safety requirements or standards, regardless of any support or applications information provided by **onsemi**. "Typical" parameters which may be provided in **onsemi** data sheets and/or specifications can and do vary in different applications and actual performance may vary over time. All operating parameters, including "Typicals" must be validated for each customer application by customer's technical experts. **onsemi** does not convey any license under any of its intellectual property rights nor the rights of others. **onsemi** products are not designed, intended, or authorized for use as a critical component in life support systems or any FDA Class 3 medical devices or medical devices with a same or similar classification in a foreign jurisdiction or any devices intended for implantation in the human body. Should Buyer purchase or use **onsemi** products for any such unintended or unauthorized application, Buyer shall indemnify and hold **onsemi** and its officers, employees, subsidiaries, affiliates, and distributors harmless against all claims, costs, damages, and expenses, and reasonable attorney fees arising out of, directly or indirectly, any claim of personal injury or death associated with such unintended or unauthorized use, even if such claim alleges that **onsemi** was negligent regarding the design or manufacture of the part. **onsemi** is an Equal Opportunity/Affirmative Action Employer. This literature is subject to all applicable copyright laws and is not for resale in any manner.

---

## ADDITIONAL INFORMATION

### TECHNICAL PUBLICATIONS:

Technical Library: [www.onsemi.com/design/resources/technical-documentation](http://www.onsemi.com/design/resources/technical-documentation)  
onsemi Website: [www.onsemi.com](http://www.onsemi.com)

### ONLINE SUPPORT: [www.onsemi.com/support](http://www.onsemi.com/support)

For additional information, please contact your local Sales Representative at [www.onsemi.com/support/sales](http://www.onsemi.com/support/sales)

