

High-frequency AC Method

Fan Type Ionizer

ER-F SERIES

No compressed air necessary



ER-F SERIES

No compressed air necessary

CE



A compact shape for reducing workbench clutter

Compact size of 150 × 166 × 62 mm 5.906 × 6.535 × 2.441 in
Low-volume fan type also available for various applications

An ionizer with a 120 mm 4.724 in fan diameter that has a class leading compact size for reducing workbench clutter and increasing efficiency. Low-volume fan type with a suppressed fan speed of approx. half is available for charge removal in processes which involve handling of small parts or thin films.

* Graphs represent typical values at 300 mm 11.811 in from directly in front of air outlet, straight louver, with no filter installed.

Standard fan type ER-F12A

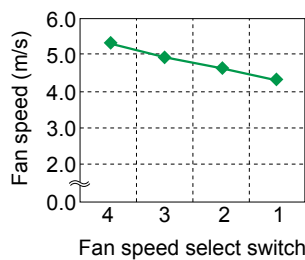

Low-volume fan type ER-F12SA

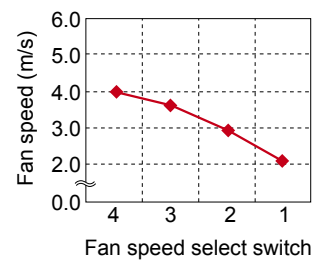

Two exchangeable louvers to suit your needs

Just simply replace the louver to change configuration between long distance and wide area ionization.

The two louvers come with the ionizer main body.

Straight louver



Removes charges quickly at long distance

Angle louver



Removes charges completely in wide area

APPLICATIONS

Prevention of static charge in cell production

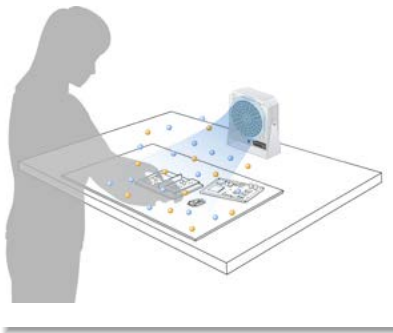

Equipped with discharge needle fouling detection function

New function

Additionally equipped with discharge needle fouling detection function. When discharge becomes weak due to needle fouling, the DSC indicator will flash for notification.



Remove the louver for effortless maintenance

Because the discharge needle unit is attached to the louver, exchange or maintenance of the needles is made easy without touching the main unit. A safe design where once the louver is removed, the high-voltage circuit and the fan will halt.



ORDER GUIDE

| Type | Appearance | Charge removal time (±1,000 V → ±100 V) | Ion balance | Model No. |
|---------------------|------------|--|---------------------------|-----------------|
| Standard fan type | | 1 sec. approx. (Note 1) | ±10 V or less (Note 2) | ER-F12A |
| Low-volume fan type | | 1.5 sec. approx. (Note 1) | | ER-F12SA |

Notes: 1) Typical value at 200 mm **7.874 in** from directly in front of air outlet, fan speed MAX, straight louver, with no filter installed.
2) Typical value at 300 mm **11.811 in** from directly in front of air outlet, fan speed MAX, straight louver, with no filter installed.

OPTIONS

| Type | Model No. | Description |
|-----------------------|-----------------------------|--|
| AC adaptor | ER-FAPS-J2 | IN: 100-240 V AC 50/60 Hz OUT: 24 V DC, 1.5 A |
| | ER-FAPS-EX (Note) | Cable length between connector and AC adaptor: 1.8 m 5.905 ft AC cable: 125 V rated (an accessory to ER-FAPS-J2 only) |
| Discharge needle unit | ER-F12ANT | Unit with tungsten needles (1 pc.) |
| Air filter | ER-F12FX5 | Replacement filter (5 pcs. per set) |

Note: Please prepare an AC cable separately as it is needed.



Inlet configuration (IEC 60320-C13)

SPECIFICATIONS

| Item | Type | Standard fan type | Low-volume fan type |
|--|--------------------------|--|---------------------------|
| | Model No. | ER-F12A | ER-F12SA |
| CE marking directive compliance | | EMC Directive, RoHS Directive | |
| Charge removal time ($\pm 1,000$ V \rightarrow ± 100 V) | | 1 sec. approx. (Note 2) | 1.5 sec. approx. (Note 2) |
| Ion balance | | ± 10 V or less (Note 3) | |
| Power supply voltage | | 24 V DC ± 10 % | |
| Power consumption | | 700 mA or less | 400 mA or less |
| Discharge method | | High-frequency AC method | |
| Discharge output voltage | | ± 2 kV approx. | |
| Max. fan speed | | 5.3 m/s (Note 3) | 4.0 m/s (Note 3) |
| Max. fan volume | | 3.68 m ³ /min. | 2.50 m ³ /min. |
| Error output | | NPN open-collector transistor • Max. sink current: 50 mA • Applied voltage: 30 V DC or less (between output terminal and 0 V) • Residual voltage: 1 V or less (at input current of 50 mA) | |
| | Output operation | OFF when discharge error or fan error detected Normally ON | |
| | Short-circuit protection | Incorporated | |
| Discharge halt input | | Discharge halt: Short-circuited to 0 V Discharge (operation start): Open | |
| Indicators | | Discharge error (Red), Fan error (Red), Power (Green), Discharge (Green) | |
| Ozone generation amount | | 0.04 ppm or less (Note 2) | |
| Ambient temperature | | 0 to +50 °C +32 to +122 °F (No dew condensation allowed), Storage: -10 to +65 °C +14 to +149 °F | |
| Ambient humidity | | 35 to 65 % RH (No dew condensation allowed), Storage: 35 to 65 % RH | |
| Grounding method | | C (capacitor) grounding | |
| Material | | Enclosure: ABS, Louver: ABS, Discharge needle unit: PBT, Discharge needle: Tungsten, Bracket: SPHC | |
| Weight | | Net weight: 790 g approx. | |
| Accessories | | Straight louver: 1 pc. (Note 4), Angle louver: 1 pc., Caution label: 1 set, Rubber cushion: 1 pc. | |

Notes: 1) Where measurement conditions have not been specified precisely, the conditions used were an ambient temperature of +20 °C +68 °F.
 2) Typical value at 200 mm 7.874 in from directly in front of air outlet, fan speed MAX., straight louver, with no filter installed.
 3) Typical value at 300 mm 11.811 in from directly in front of air outlet, fan speed MAX., straight louver, with no filter installed.
 4) The discharge needle unit is loaded on the straight louver before shipment.

I/O CIRCUIT AND WIRING DIAGRAMS

I/O circuit diagram

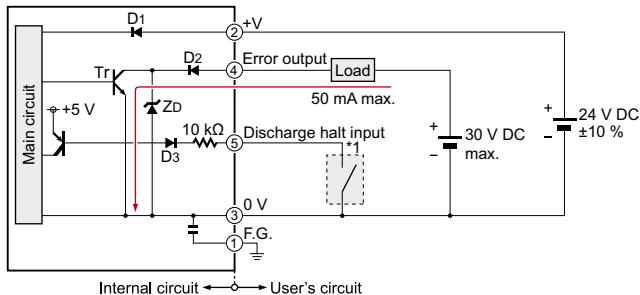

* 1

Non-voltage contact or NPN open-collector transistor

Low (0 V): Discharge halt
 High (Open): Discharge (Operation starts)

Symbols ... D1 : Reverse supply polarity protection diode
 D2 : Output protection diode
 D3 : Input protection diode
 ZD : Surge absorption zener diode
 Tr : NPN output transistor

Connector terminal arrangement

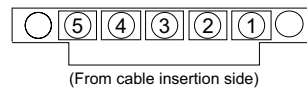

| Terminal No. | Color code |
|--------------|----------------------|
| ① | F.G. |
| ② | +V |
| ③ | 0 V |
| ④ | Error output |
| ⑤ | Discharge halt input |

Recommended wiring cable

Compatible wire: 25 AWG to 12 AWG (nominal cross-sectional area: 0.16 to 3.3 mm²)
 Wire stripping length: 7 mm 0.276 in (see below)

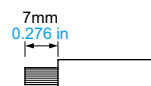

Note: Do not solder-plate the ends of wires being connected to connectors. Doing so may result in loosening of tightened screws, causing the wire to come loose.

CHARGE REMOVAL CHARACTERISTICS (TYPICAL)

Measured using a 150 × 150 mm 5.906 × 5.906 in CPM (charge plate monitor) (At center of CPM)

ER-F12A ER-F12SA

Solid lines in the graphs show **ER-F12A**. Dotted lines show **ER-F12SA**.

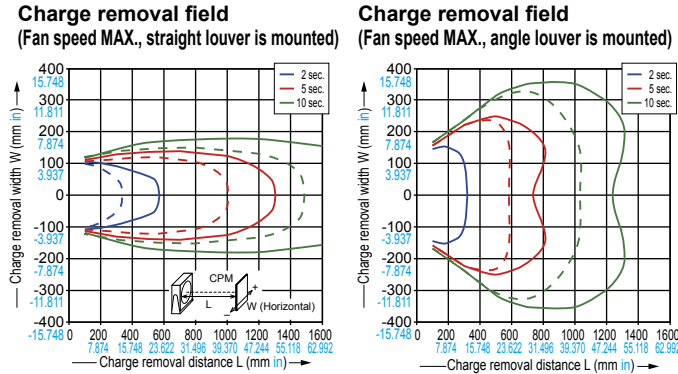

PRECAUTIONS FOR PROPER USE



- Never use this product in a device for personnel protection.
- In case of using sensing devices for personnel protection, use products which meet laws and standards, such as OSHA, ANSI or IEC etc., for personnel protection applicable in each region or country.
- Do not use this product in places where there may be a danger of flammable or combustible items being present.
- If this product is used in an airtight room, ozone emitted from this product may be detrimental. Therefore, in order for this product to be used in an airtight room, be sure to keep the room ventilated.
- Since the tip of the discharge needle is sharp, take sufficient care in handling the discharge needle.
- Clean the discharge needle regularly, otherwise optimum charge removal performance may not be obtained and fire or operating problems may occur.
- Be sure to ground the frame ground (F.G.) terminal.

DIMENSIONS (Unit: mm in)

The CAD data can be downloaded from our website.

ER-F12A ER-F12SA

Ionizer main unit

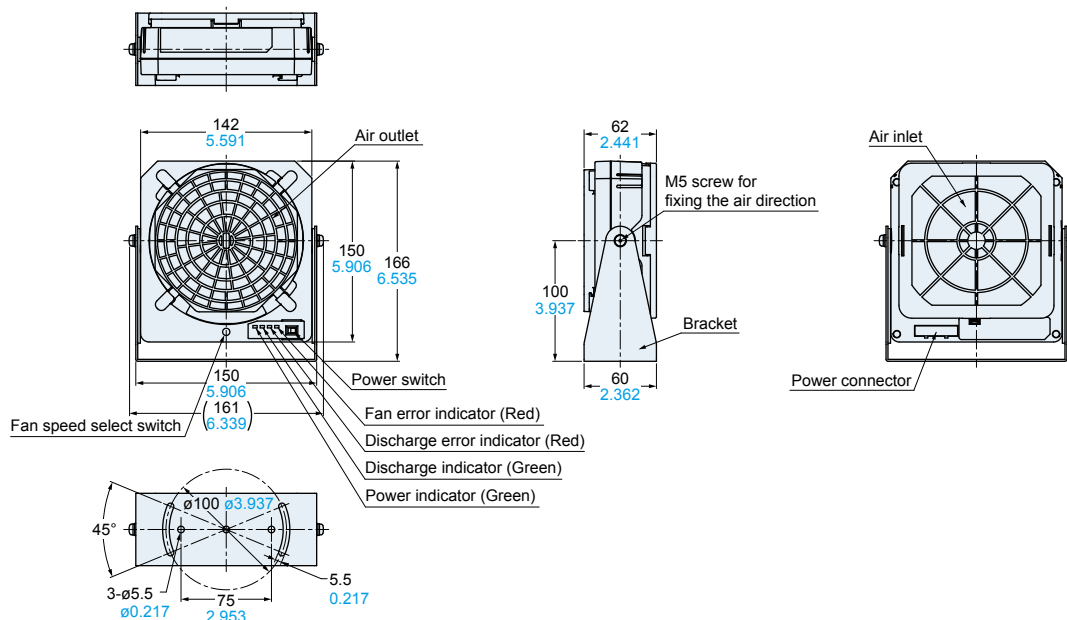

Disclaimer

The applications described in the catalog are all intended for examples only. The purchase of our products described in the catalog shall not be regarded as granting of a license to use our products in the described applications. We do NOT warrant that we have obtained some intellectual properties, such as patent rights, with respect to such applications, or that the described applications may not infringe any intellectual property rights, such as patent rights, of a third party.

Panasonic
INDUSTRY

Panasonic Industry Co., Ltd.

Industrial Device Business Division

7-1-1, Morofuku, Daito-shi, Osaka 574-0044, Japan

industrial.panasonic.com/ac/e/