

PART NUMBER: EPA240050-P5-SZ

DESCRIPTION: linear adapter

SPECIFICATIONS

output voltage	24 V ac at 500 mA	
rated input voltage	120 V ac	
primary rated voltage	120 V ac 60 Hz 18 W	
primary exciting current	30 mA rms max.	
secondary rated voltage & current	no load voltage (max.)	30.3 V
	full load voltage (500 mA)	24 V \pm 5%
temperature rise of primary winding (full load)	70°C max. using resistance method	
insulation resistance	\geq 100 M Ohm at 500 Vdc	
HI-POT test	primary to secondary	1240 V ac at 2 mA for 1 minute
	primary to secondary	1600 V ac at 2 mA for 1 second
	primary winding to secondary winding	1600 V ac at 2 mA for 1 second
	primary winding to core	1600 V ac at 2 mA for 1 second
	secondary winding to core	750 V ac at 2 mA for 1 second
safety standard	UL/cUL	
weight	388 g	
RoHS compliant	yes	
test conditions	ambient temp	40 \pm 2°C
	humidity	90~95% 96 hours at Full Load
adapter color	case	black
	cord	black

PART NUMBER: EPA240050-P5-SZ

DESCRIPTION: linear adapter

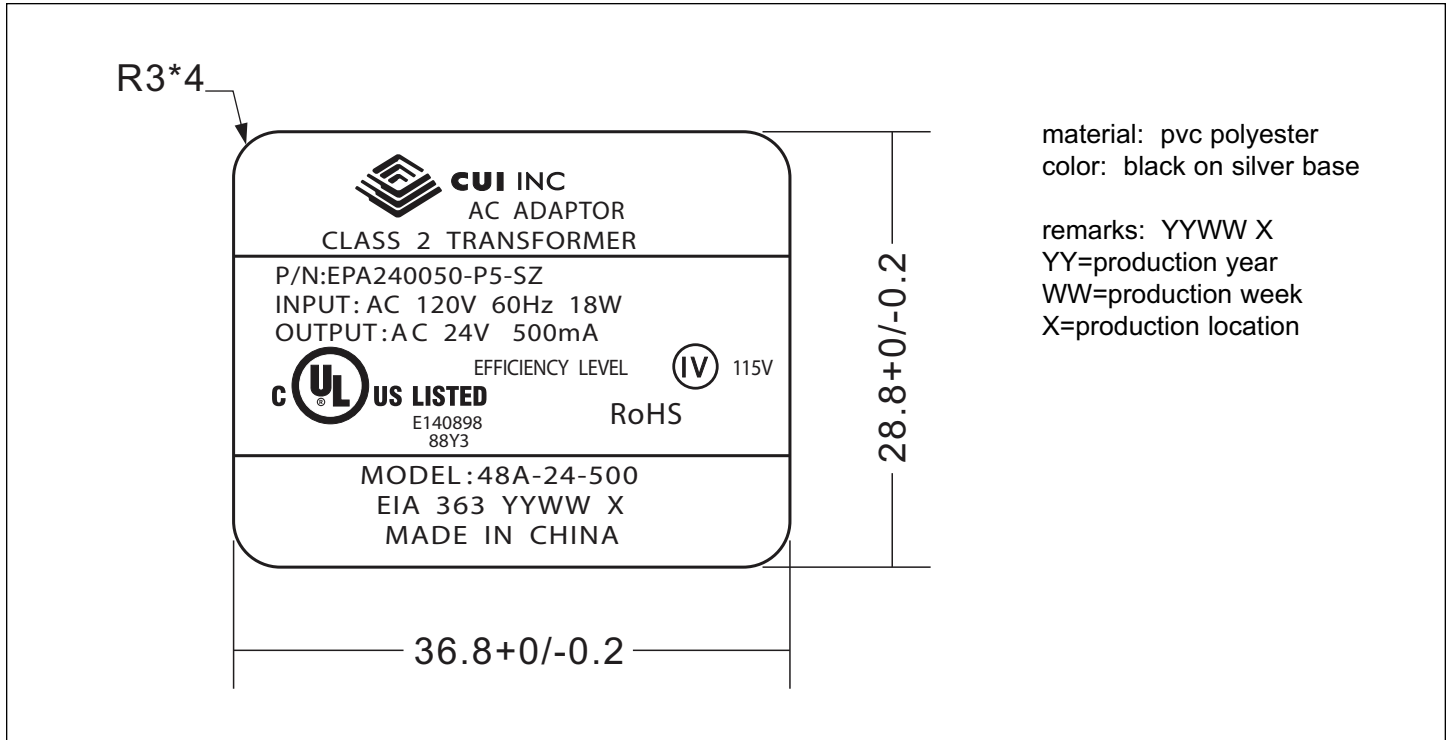
LABEL

PART NUMBER: EPA240050-P5-SZ

DESCRIPTION: linear adapter

CIRCUIT DIAGRAM

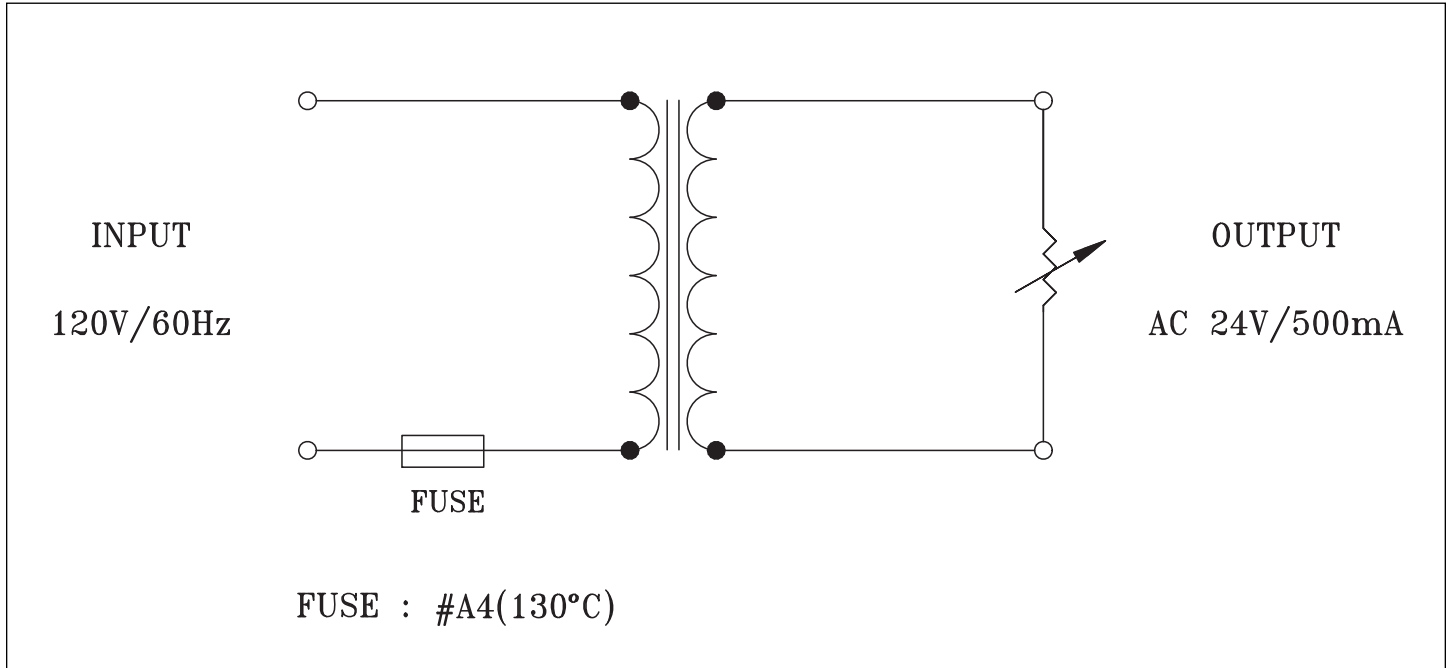

TEST CIRCUIT

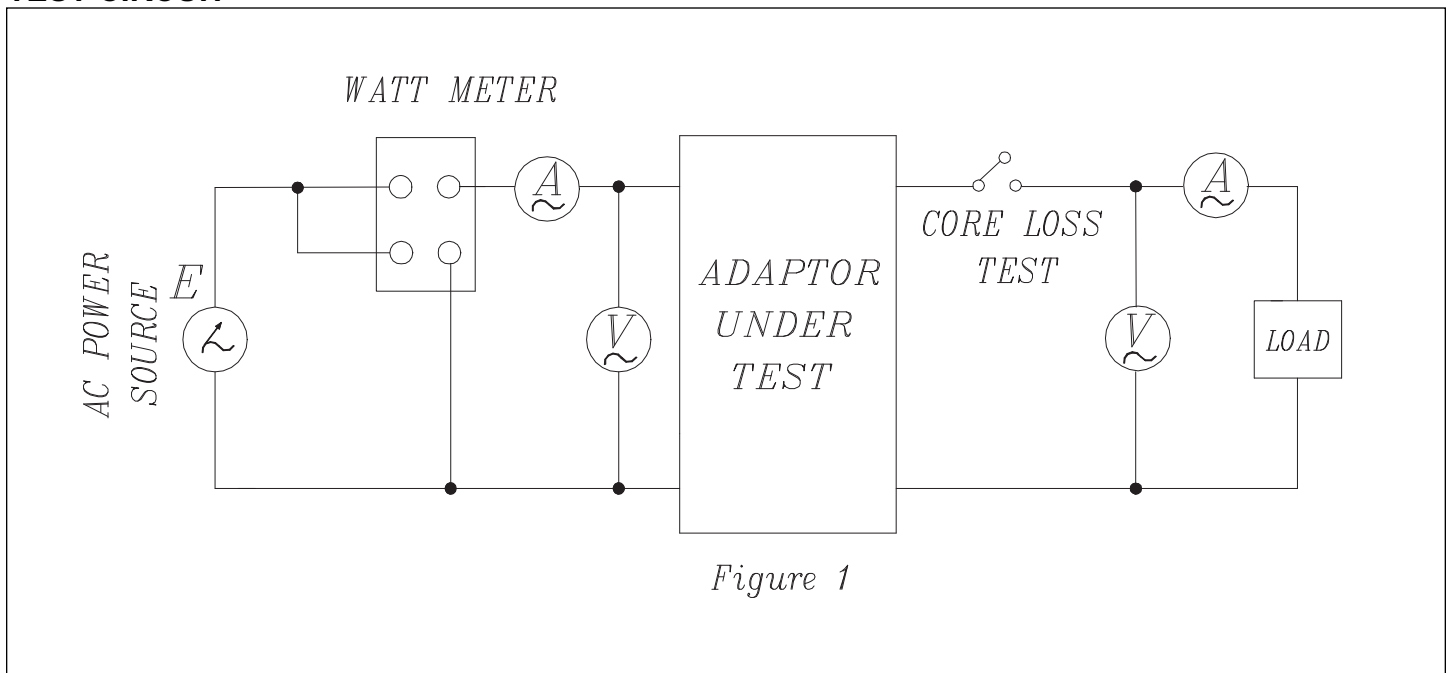

PART NUMBER: EPA240050-P5-SZ

DESCRIPTION: linear adapter

MECHANICAL DRAWING

tolerance	±1mm
weight	388 g

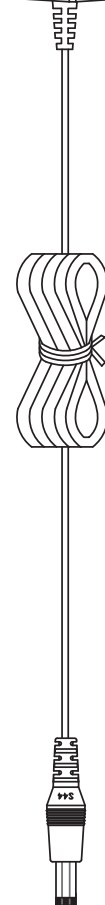
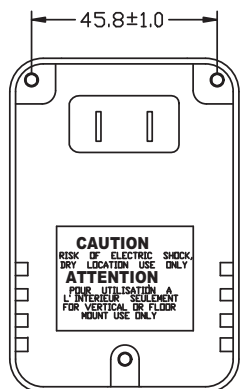
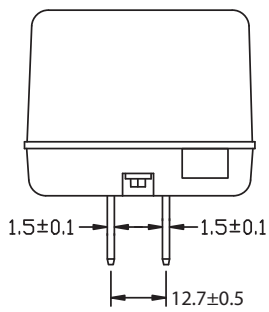
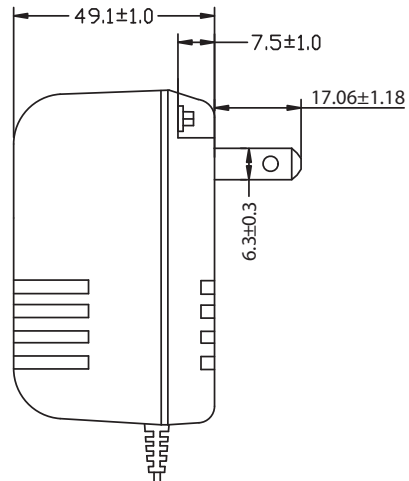
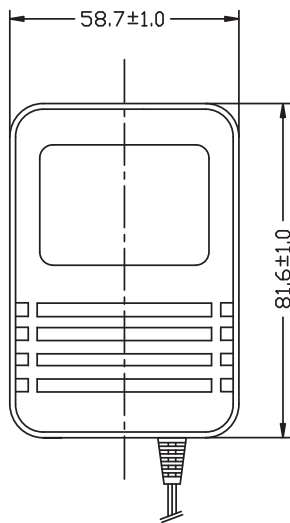

PART NUMBER: EPA240050-P5-SZ

DESCRIPTION: linear adapter

DC CORD

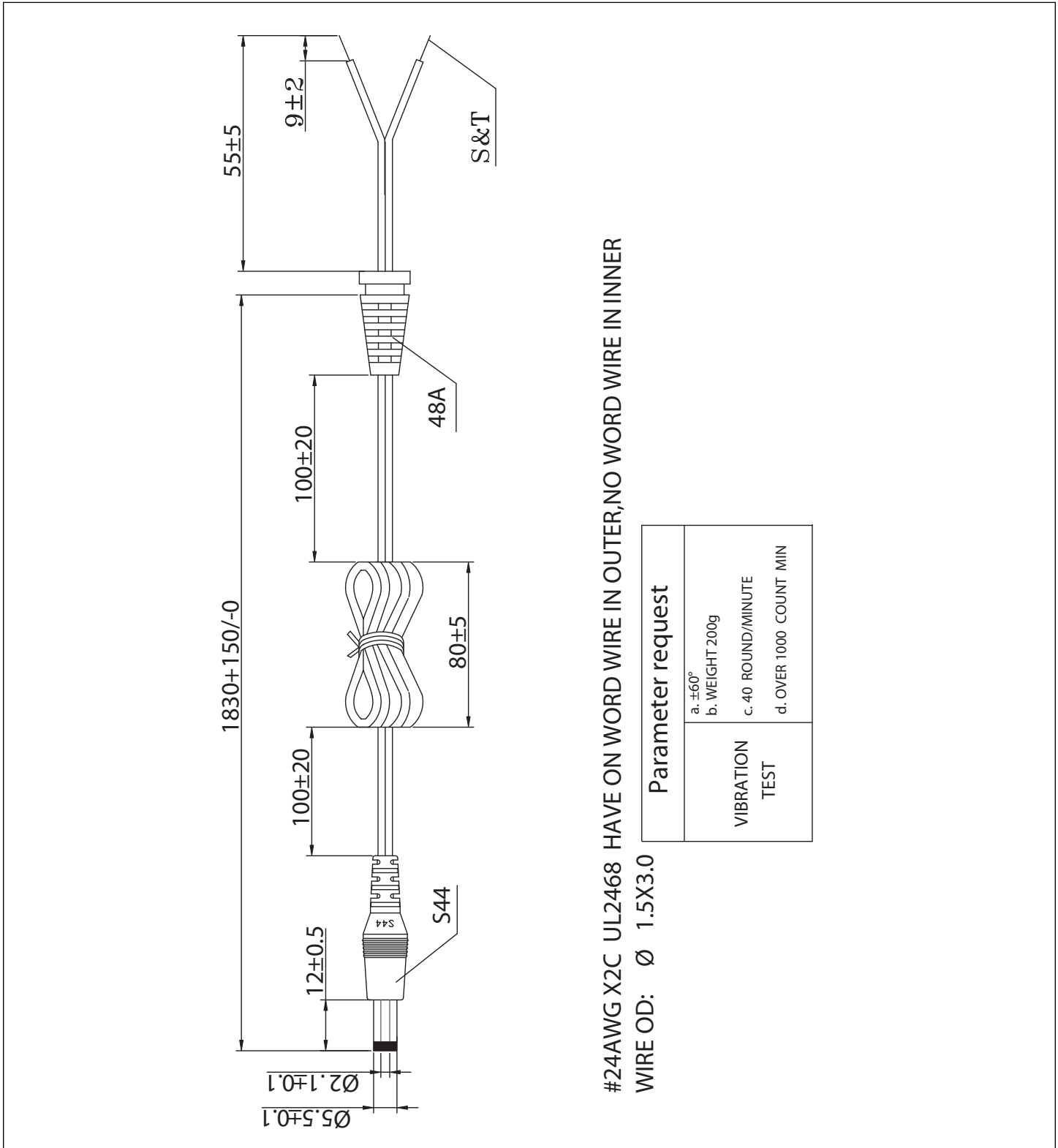

#24AWG X2C UL2468 HAVE ON WORD WIRE IN OUTER,NO WORD WIRE IN INNER
WIRE OD: Ø 1.5X3.0

Parameter request	
VIBRATION TEST	a. ±60° b. WEIGHT 200g c. 40 ROUND/MINUTE d. OVER 1000 COUNT MIN

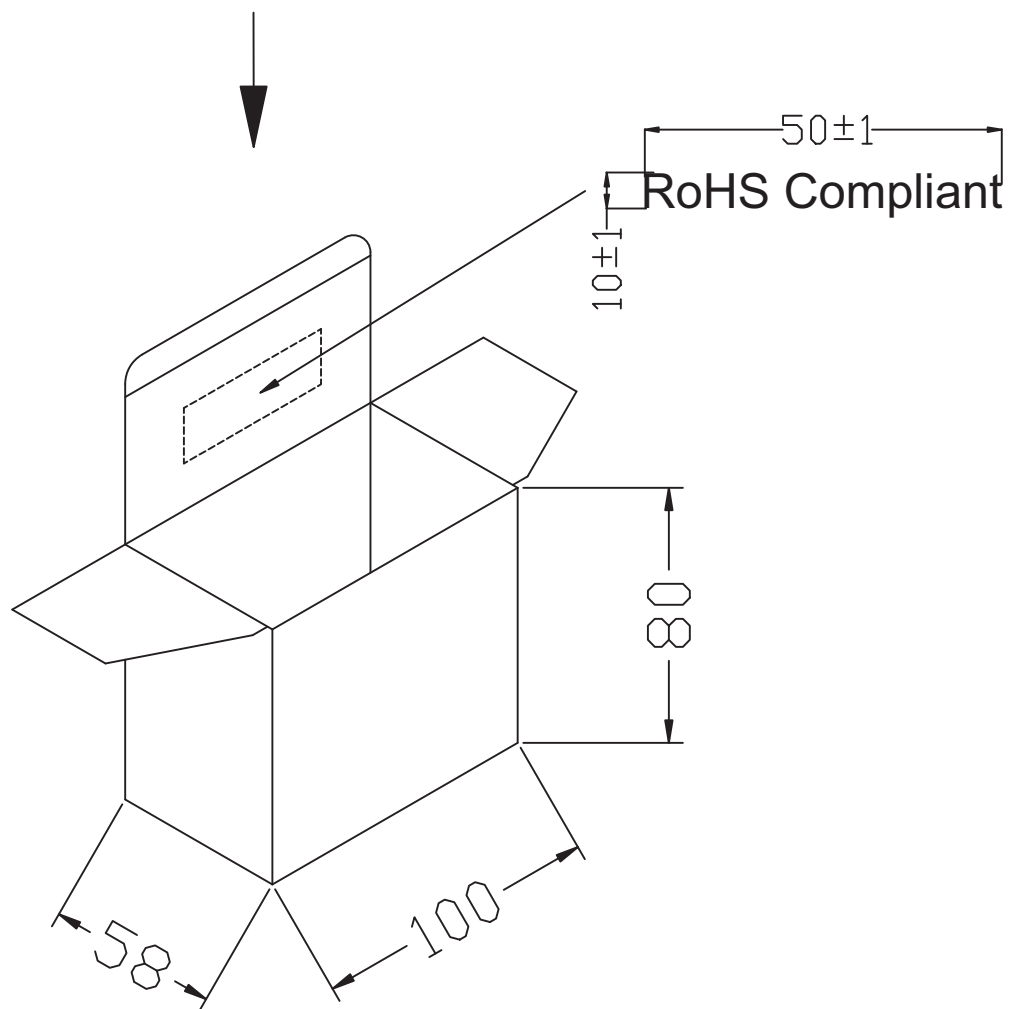
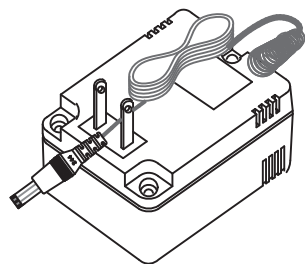
PART NUMBER: EPA240050-P5-SZ**DESCRIPTION:** linear adapter**INDIVIDUAL PACKAGING**tolerance: ± 1 

PART NUMBER: EPA240050-P5-SZ**DESCRIPTION:** linear adapter**PACKAGING**

tolerance: +7/-0

OUTSIDE CARTON:A=B(6mm)

INSIDE CARTON:B3B(3mm)

CARTON SIZE: 430x223x269mm

Q'TY: 40pcs(10X4X1)

