

## 4 A Sensitive gate SCR in IPAK package

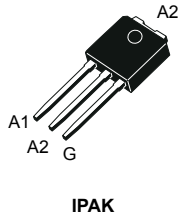

### Features

- 4 A SCR
- Sensitive SCR:  $I_{GT} = 50 \mu\text{A}$
- $V_{DRM} / V_{RRM} = 600 \text{ V}$  and  $V_{DSM} / V_{RSM} = 750 \text{ V}$
- 125 °C maximum junction temperature  $T_j$
- IPAK package
- Halogen-free molding, lead-free plating
- ECOPACK2 compliant

### Applications

- Actuators
- Igniters
- Inrush current limiting circuits

### Description

The X04 series is 4 A SCR housed in compact through hole IPAK package. This highly sensitive device is suited to home appliances or power tools and industrial systems and drives loads up to 4 A.

#### Product status link

[X0405MH](#)

#### Product summary

$I_{T(RMS)}$	4 A
$V_{DSM}/V_{RSM}$	750 V
$I_{GT}$	50 $\mu\text{A}$
$T_j \text{ max.}$	125 °C

# 1 Characteristics

**Table 1. Absolute maximum ratings (limiting values)**

Symbol	Parameter	Value	Unit
$I_{T(RMS)}$	RMS on-state current (full sine wave)	$T_c = 114\text{ °C}$	4 A
$I_{TAV}$	RMS on-state average current (full sine wave)	$T_c = 114\text{ °C}$	2.5 A
$I_{TSM}$	Non repetitive surge peak on-state current (full cycle, $T_j$ initial = 25 °C)	$t = 8.3\text{ ms}$	33 A
		$t = 10\text{ ms}$	30 A
$I^2t$	$I^2t$ value for fusing	$t_p = 10\text{ ms}$	9 A <sup>2</sup> s
$di/dt$	Critical rate of rise of on-state current, $I_G = 2 \times I_{GT}$ , $t_r \leq 100\text{ ns}$ , $f = 60\text{ Hz}$	$T_j = 125\text{ °C}$	50 A/ $\mu$ s
$V_{DRM}/V_{RRM}$	Repetitive peak off-state voltage	$T_j = 125\text{ °C}$	600 V
$V_{DSM}/V_{RSM}$	Non Repetitive peak off-state voltage, 10 ms		750 V
$I_{GM}$	Maximum peak gate current	$t_p = 20\text{ }\mu$ s, $T_j = 125\text{ °C}$	1.2 A
$P_{GM}$	Maximum gate power dissipation		0.5 W
$T_{stg}$	Storage temperature range		-40 to +125 °C
$T_j$	Operating junction temperature range		-40 to +125 °C
$T_L$	Maximum lead temperature for soldering during 10 s		260 °C

**Table 2. Electrical characteristics ( $T_j = 25\text{ °C}$ , unless otherwise specified)**

Symbol	Test conditions	Value	Unit	
$I_{GT}^{(1)}$	$V_D = 12\text{ V}$ , $R_L = 140\text{ }\Omega$	Min.	20 $\mu$ A	
		Max.	50 $\mu$ A	
$V_{GT}$		Max.	0.8 V	
$V_{GD}$	$V_D = V_{DRM}$ , $R_L = 3.3\text{ k}\Omega$	$T_j = 125\text{ °C}$	Min.	0.1 V
$V_{RGM}$	$I_{RG} = 10\text{ }\mu$ A		Max.	8 V
$I_L$	$I_G = 1.2 \times I_{GT}$		Max.	6 mA
$I_H^{(2)}$	$I_T = 500\text{ mA}$ , gate open		Max.	5 mA
$dV/dt^{(2)}$	$V_D = 67\% V_{DRM}$ , $R_{GK} = 1\text{ k}\Omega$	$T_j = 110\text{ °C}$	Min.	15 V/ $\mu$ s

- For both polarities of OUT pin referenced to COM pin.
- For both polarities of A2 referenced to A1.

**Table 3. Static characteristics**

Symbol	Test conditions	$T_j$	Value	Unit
$V_{TM}^{(1)}$	$I_{TM} = 8\text{ A}$ , $t_p = 380\text{ }\mu$ s	25 °C	Max.	1.8 V
$V_{TO}^{(1)}$	Threshold voltage	125 °C	Max.	0.85 V
$R_D^{(1)}$	Dynamic resistance	125 °C	Max.	100 m $\Omega$
$I_{DRM}/I_{RRM}$	$V_D = V_{DRM}$ ; $V_R = V_{RRM}$ ; $R_{GK} = 1\text{ k}\Omega$	25 °C	Max.	5 $\mu$ A
		125 °C		1 mA

- For both polarities of A2 referenced to A1.

**Table 4. Thermal resistance**

Symbol	Parameter		Value	Unit
$R_{th(j-c)}$	Junction to case (DC)	Max.	3	°C/W
$R_{th(j-a)}$	Junction to ambient	Typ.	70	°C/W

## 1.1 Characteristics (curves)

**Figure 1. Maximum average power dissipation versus on-state RMS current**

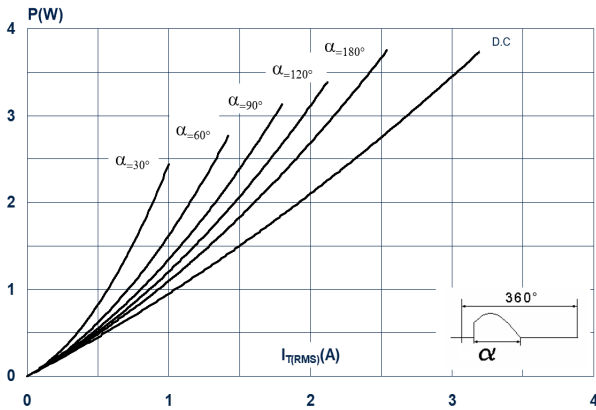

**Figure 2. Average and DC on-state current versus case temperature**

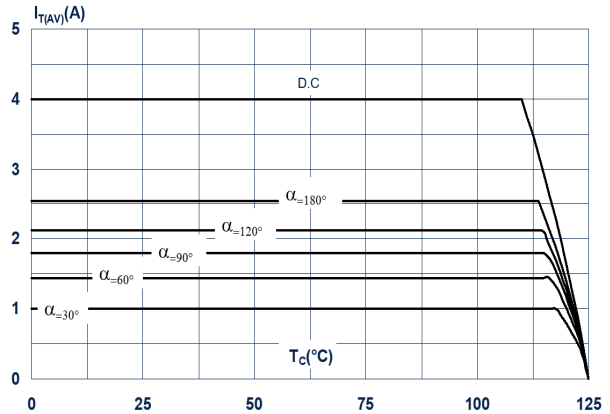

**Figure 3. On-state RMS current versus ambient temperature (full cycle)**

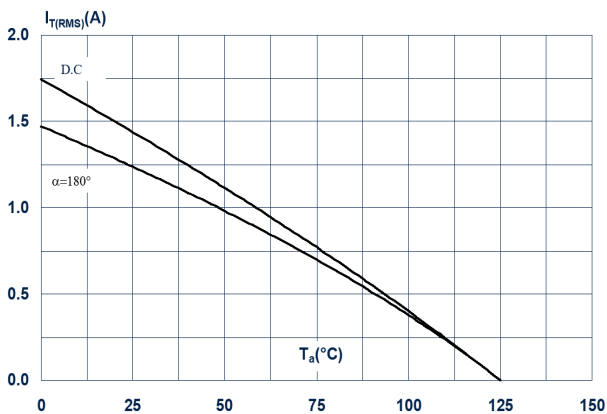

**Figure 4. Relative variation of thermal impedance versus pulse duration**

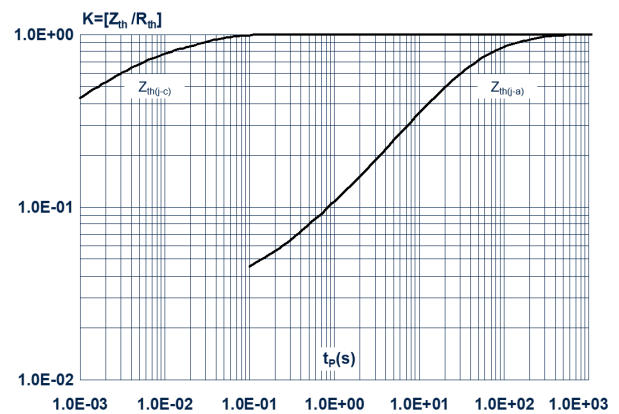

**Figure 5. Relative variation of gate triggering current and voltage versus junction temperature (typical values)**

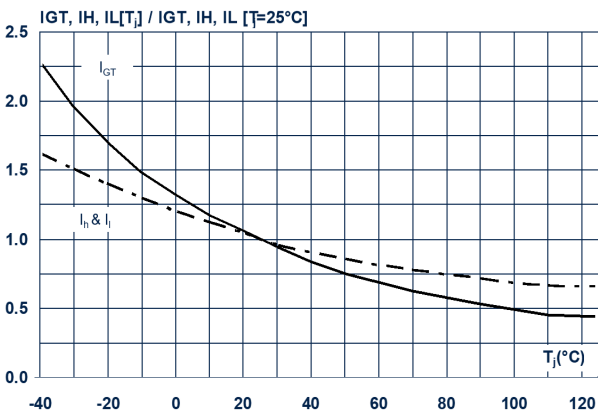

**Figure 6. Surge peak on-state current versus number of cycles**

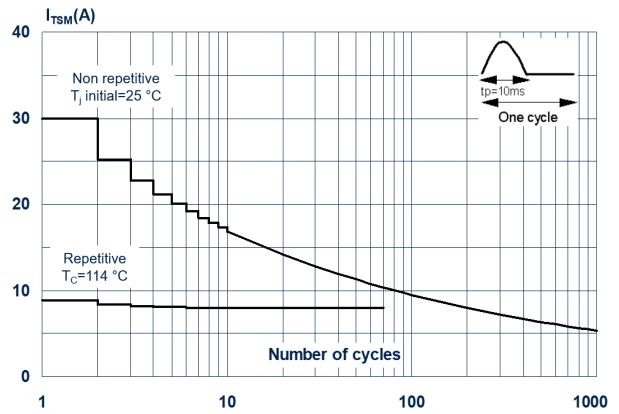

**Figure 7. Non repetitive surge peak on-state current for a sinusoidal pulse with width  $t_p < 10$  ms and corresponding value of  $I^2t$**

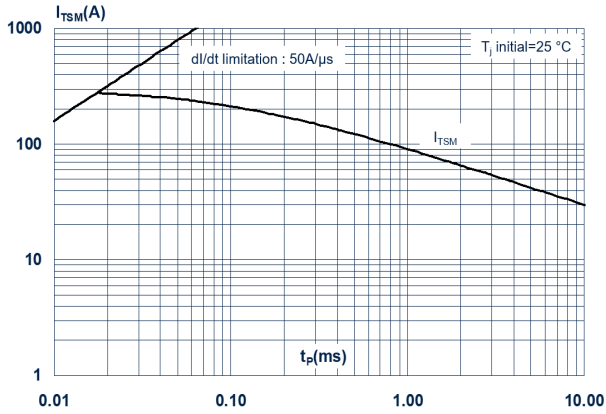

**Figure 8. On-state characteristics (maximum values)**

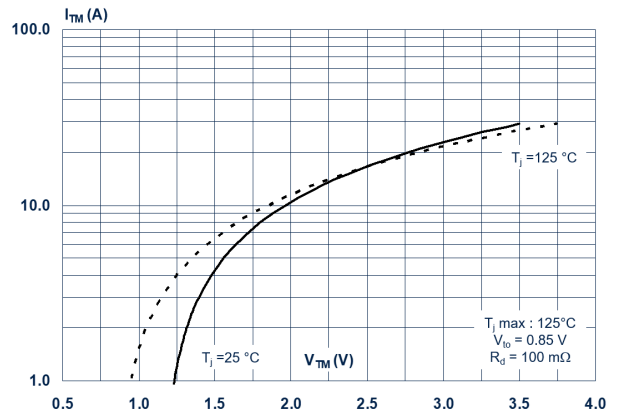

**Figure 9. Relative variation of static dV/dt immunity versus gate-to-cathode resistance (typical values)**

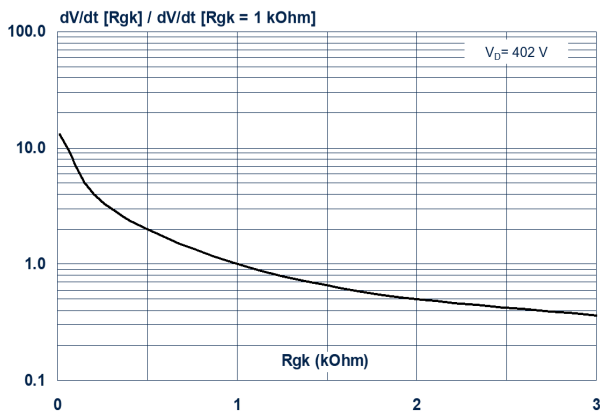

**Figure 10. Relative variation of static dV/dt immunity versus gate-to-cathode capacitance (typical values)**

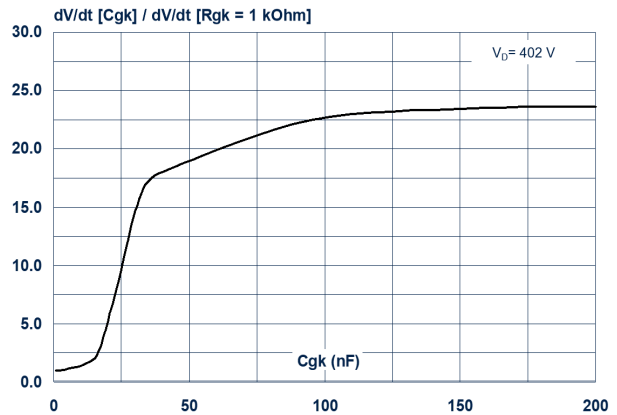

**Figure 11. Relative variation of static dV/dt immunity versus junction temperature**

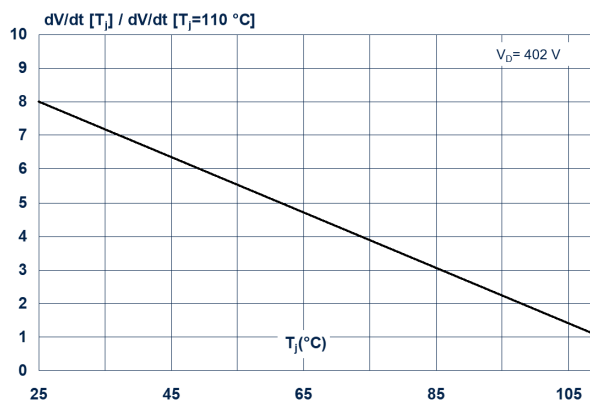

## 2 Package information

In order to meet environmental requirements, ST offers these devices in different grades of **ECOPACK** packages, depending on their level of environmental compliance. ECOPACK specifications, grade definitions and product status are available at: [www.st.com](http://www.st.com). ECOPACK is an ST trademark.

### 2.1 IPAK package information

- Molding compounded resin is halogen free and meets UL94 flammability standard, level V0
- Lead-free package leads plating

**Figure 12. IPAK package outline**

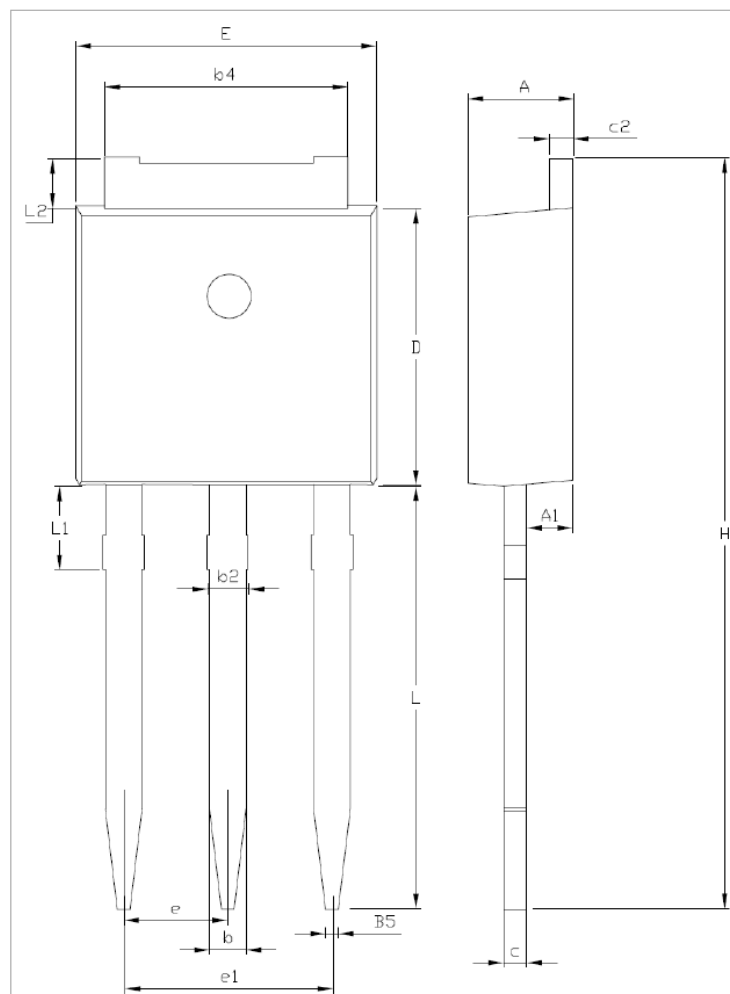

**Table 5. IPAK package mechanical data**

Ref.	Dimensions					
	MillimetersInches (for reference only)					
	Min.	Typ.	Max.	Min.	Typ.	Max.
A	2.20		2.40	0.086		0.094
A1	0.90		1.10			0.035
b	0.64		0.90	0.025		0.035
b2			0.95			0.037
b4	5.20		5.43			
B5		0.30			0.012	
c	0.45		0.60			
c2	0.46		0.60			
D	6		6.20			
E	6.40		6.65	0.252		0.262
e		2.28			0.090	
e1	4.40		4.60	0.173		0.181
H		16.10			0.634	
L	9		9.60	0.354		0.377
L1	0.8		1.20	0.031		0.047
L2		0.80	1.25		0.031	0.049
V1		10°			10°	

### 3 Ordering information

Figure 13. Ordering information scheme

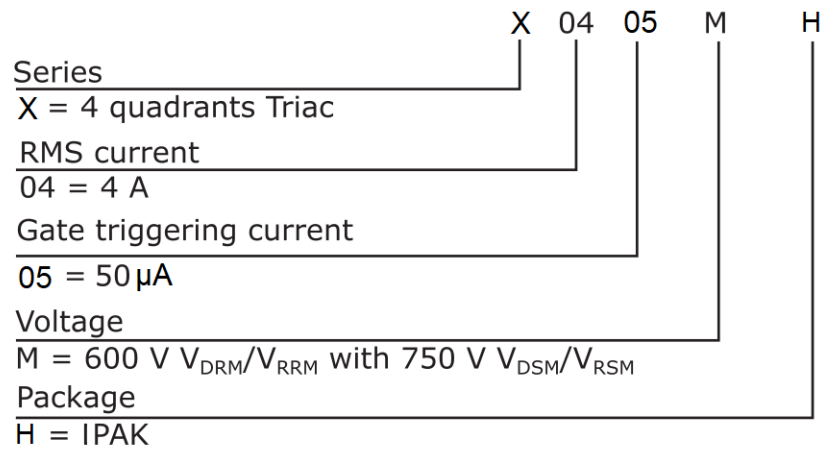

Table 6. Ordering information

Order code	Marking	Package	Weight	Base qty.	Delivery mode
X0405MH	X0405MH	IPAK	0.31 g	75	Tube



## Revision history

**Table 7. Document revision history**

Date	Revision	Changes
06-Sep-2022	1	Initial release.

**IMPORTANT NOTICE – READ CAREFULLY**

STMicroelectronics NV and its subsidiaries (“ST”) reserve the right to make changes, corrections, enhancements, modifications, and improvements to ST products and/or to this document at any time without notice. Purchasers should obtain the latest relevant information on ST products before placing orders. ST products are sold pursuant to ST’s terms and conditions of sale in place at the time of order acknowledgment.

Purchasers are solely responsible for the choice, selection, and use of ST products and ST assumes no liability for application assistance or the design of purchasers’ products.

No license, express or implied, to any intellectual property right is granted by ST herein.

Resale of ST products with provisions different from the information set forth herein shall void any warranty granted by ST for such product.

ST and the ST logo are trademarks of ST. For additional information about ST trademarks, refer to [www.st.com/trademarks](http://www.st.com/trademarks). All other product or service names are the property of their respective owners.

Information in this document supersedes and replaces information previously supplied in any prior versions of this document.

© 2022 STMicroelectronics – All rights reserved