

# EMI Filter with ESD Protection

## EMI7112

### Product Description

The EMI7112 is an L-C EMI filter array with ESD protection that integrates two Pi-filters (C-L-C) to suppress EMI/RFI Noise. EMI7112 includes ESD protection diodes on all input/output pins, and provides a very high level of protection for sensitive electronic components against possible electrostatic discharge (ESD). The ESD diodes connected to the filter ports safely dissipate ESD strikes of  $\pm 30$  kV, which is beyond the maximum requirement of the IEC61000-4-2 international standard.

### Features

- Two Channels of EMI Filtering
- $\pm 30$  kV ESD Protection (IEC 61000-4-2, Contact Discharge)
- $\pm 30$  kV ESD Protection (IEC 61000-4-2, Air Discharge)
- Greater than 45 dB of Attenuation at 900 MHz
- These Devices are Pb-Free, Halogen Free/BFR Free and are RoHS Compliant

### Applications

- Mobile Phones

### MAXIMUM RATINGS ( $T_A = 25^\circ\text{C}$ )

Rating	Symbol	Value	Unit
ESD Discharge IEC61000-4-2 Contact Discharge Air Discharge	$V_{pp}$	30 30	kV
RMS Current per Line	$I_{Line}$	350	mA
Operating Temperature Range	$T_J$	-40 to +125	$^\circ\text{C}$
Storage Temperature Range	$T_{stg}$	-55 to +150	$^\circ\text{C}$
Lead Solder Temperature (10 second duration)	$T_L$	260	$^\circ\text{C}$

Stresses exceeding those listed in the Maximum Ratings table may damage the device. If any of these limits are exceeded, device functionality should not be assumed, damage may occur and reliability may be affected.



ON Semiconductor®

[www.onsemi.com](http://www.onsemi.com)



WLCSP5  
FC SUFFIX  
CASE 567KK

### BLOCK DIAGRAM

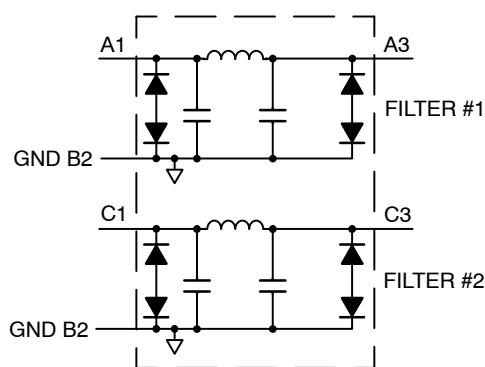

### MARKING DIAGRAM



7A = Specific Device Code  
M = Date Code

### ORDERING INFORMATION

Device	Package	Shipping†
EMI7112FCTAG	WLCSP5 (Pb-Free)	5000/Tape & Reel

†For information on tape and reel specifications, including part orientation and tape sizes, please refer to our Tape and Reel Packaging Specification Brochure, BRD8011/D.

**Table 1. PIN DESCRIPTIONS**

Pin	Name	Description
A1	Filter #1	Filter #1 Input/Output
A3	Filter #1	Filter #1 Input/Output
C1	Filter #2	Filter #2 Input/Output
C3	Filter #2	Filter #2 Input/Output
B2	GND	Device Ground

**PACKAGE/PINOUT DIAGRAMS**

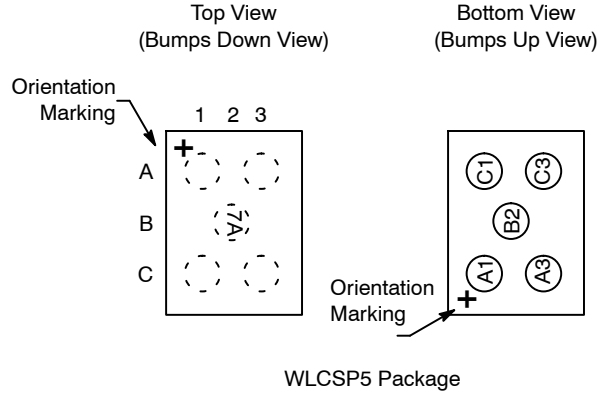

**Table 2. ELECTRICAL OPERATING CHARACTERISTICS** ( $T_A = 25^\circ\text{C}$  unless otherwise noted)

Symbol	Parameter	Test Conditions	Min	Typ	Max	Unit
$V_{RWM}$	Working Voltage			3.0		V
$V_{BR}$	Breakdown Voltage	$I_T = 1 \text{ mA}$ ; (Note 4)	6.0			V
$I_{LEAK}$	Channel Leakage Current	$V_{IN} = 3.0 \text{ V}$ , $GND = 0 \text{ V}$			400	nA
$R_{CH}$	Channel Resistance (Pins A1 – A3, C1 – C3)			0.35	0.8	$\Omega$
$C_t$	Line Capacitance	$V_R = 0 \text{ V}$ , $f = 1 \text{ MHz}$	185	250	315	pF
$f_{3dB}$	Cut-off Frequency	50 $\Omega$ Source and Load Termination		20		MHz
$F_{atten}$	Stop Band Attenuation	@ 700 MHz @ 900 MHz		40 47		dB
$V_{ESD}$	In-system ESD Withstand Voltage a) Contact discharge per IEC 61000-4-2 standard, Level 4 (External Pins) b) Contact discharge per IEC 61000-4-2 standard, Level 1 (Internal Pins)	(Notes 1 and 2)	$\pm 30$ $\pm 30$			kV
$V_{CL}$	TLP Clamping Voltage	Forward $I_{PP} = 8 \text{ A}$ Forward $I_{PP} = 16 \text{ A}$ Forward $I_{PP} = \pm 8 \text{ A}$ Forward $I_{PP} = \pm 16 \text{ A}$		9.77 11.51 -9.66 -11.67		V

Product parametric performance is indicated in the Electrical Characteristics for the listed test conditions, unless otherwise noted. Product performance may not be indicated by the Electrical Characteristics if operated under different conditions.

- Standard IEC61000-4-2 with  $C_{Discharge} = 150 \text{ pF}$ ,  $R_{Discharge} = 330$ , GND grounded.
- These measurements performed with no external capacitor.
- TVS devices are normally selected according to the working peak reverse voltage ( $V_{RWM}$ ), which should be equal to or greater than the DC or continuous peak operating voltage level.
- $V_{BR}$  is measured at pulse test current  $I_T$ .

PERFORMANCE INFORMATION

Typical Filter Performance (nominal conditions unless specified otherwise, 50 Ω Environment)

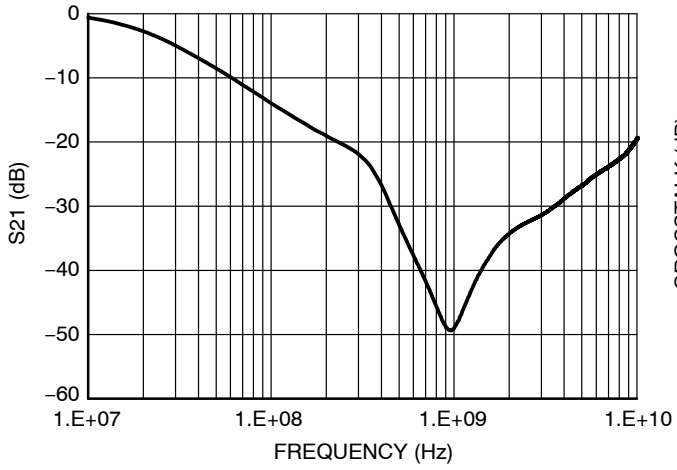

Figure 1. Typical Insertion Loss

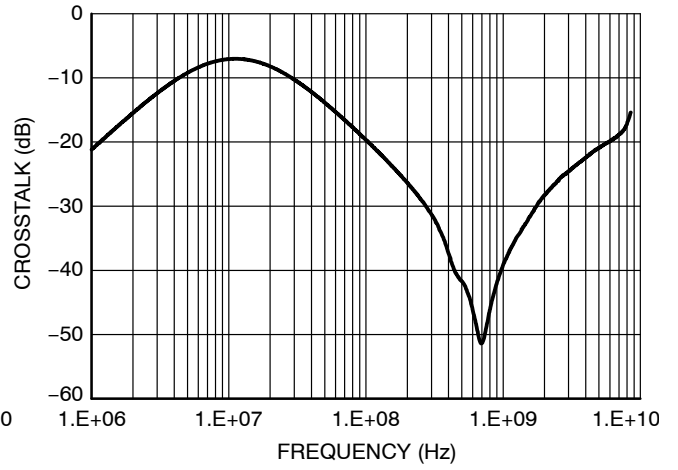

Figure 2. Typical Channel to Channel Crosstalk

IEC 61000-4-2 Spec.

Level	Test Voltage (kV)	First Peak Current (A)	Current at 30 ns (A)	Current at 60 ns (A)
1	2	7.5	4	2
2	4	15	8	4
3	6	22.5	12	6
4	8	30	16	8

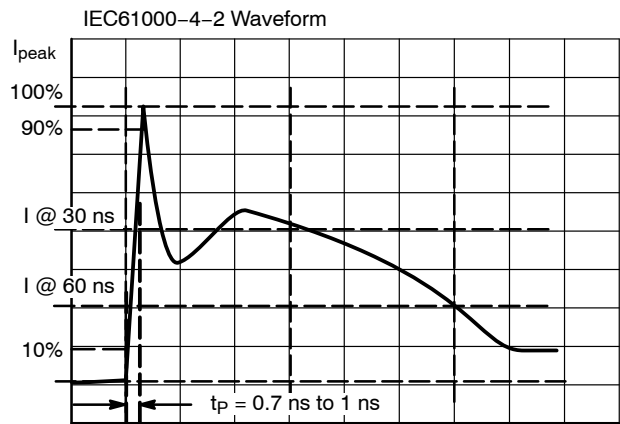

Figure 3. IEC61000-4-2 Spec

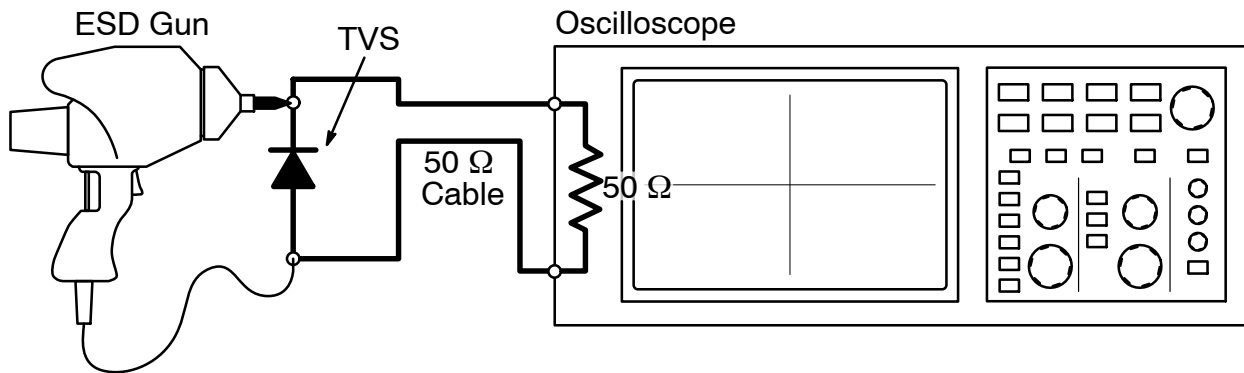

Figure 4. Diagram of ESD Clamping Voltage Test Setup

The following is taken from Application Note AND8308/D – Interpretation of Datasheet Parameters for ESD Devices.

**ESD Voltage Clamping**

For sensitive circuit elements it is important to limit the voltage that an IC will be exposed to during an ESD event to as low a voltage as possible. The ESD clamping voltage is the voltage drop across the ESD protection diode during an ESD event per the IEC61000-4-2 waveform. Since the IEC61000-4-2 was written as a pass/fail spec for larger

systems such as cell phones or laptop computers it is not clearly defined in the spec how to specify a clamping voltage at the device level. ON Semiconductor has developed a way to examine the entire voltage waveform across the ESD protection diode over the time domain of an ESD pulse in the form of an oscilloscope screenshot, which can be found on the datasheets for all ESD protection diodes. For more information on how ON Semiconductor creates these screenshots and how to interpret them please refer to AND8307/D.

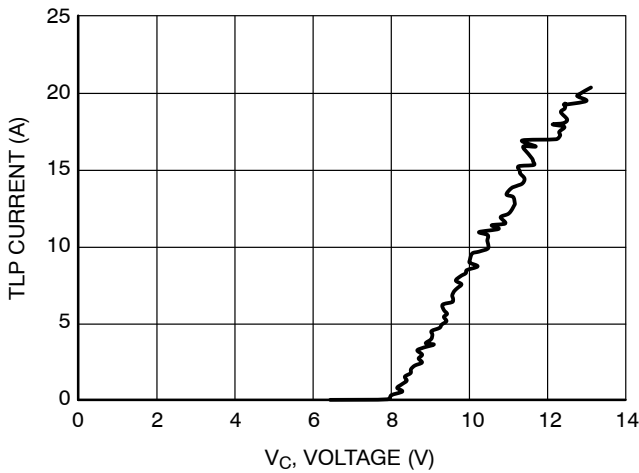

Figure 5. Positive TLP I-V Curve

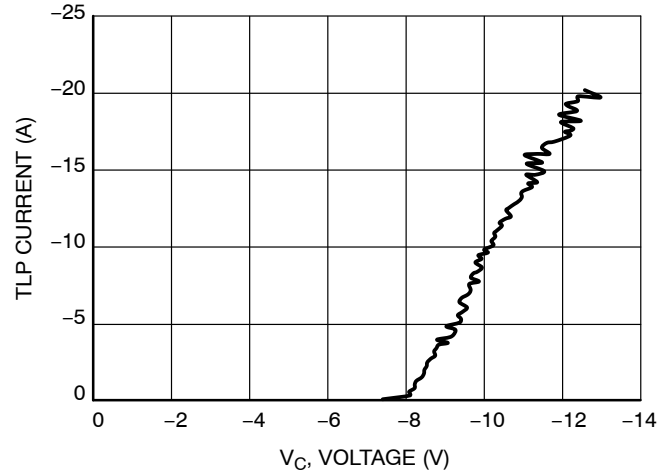

Figure 6. Negative TLP I-V Curve

NOTE: TLP parameter:  $Z_0 = 50 \Omega$ ,  $t_p = 100 \text{ ns}$ ,  $t_r = 300 \text{ ps}$ , averaging window:  $t_1 = 30 \text{ ns}$  to  $t_2 = 60 \text{ ns}$ .  $V_{IEC}$  is the equivalent voltage stress level calculated at the secondary peak of the IEC 61000-4-2 waveform at  $t = 30 \text{ ns}$  with  $2 \text{ A/kV}$ . See TLP description below for more information.

**Transmission Line Pulse (TLP) Measurement**

Transmission Line Pulse (TLP) provides current versus voltage (I-V) curves in which each data point is obtained from a 100 ns long rectangular pulse from a charged transmission line. A simplified schematic of a typical TLP system is shown in Figure 7. TLP I-V curves of ESD protection devices accurately demonstrate the product’s ESD capability because the 10s of amps current levels and under 100 ns time scale match those of an ESD event. This is illustrated in Figure 8 where an 8 kV IEC 61000-4-2 current waveform is compared with TLP current pulses at 8 A and 16 A. A TLP I-V curve shows the voltage at which the device turns on as well as how well the device clamps voltage over a range of current levels.

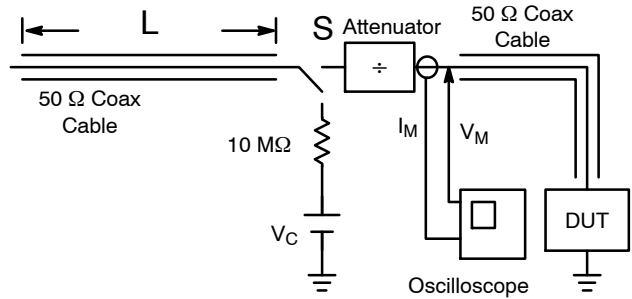

Figure 7. Simplified Schematic of a Typical TLP System

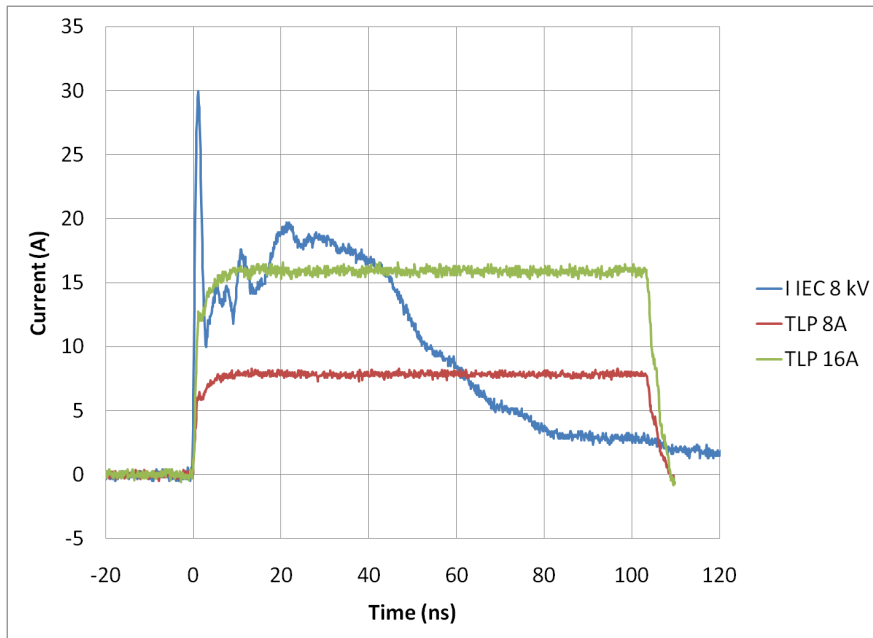

Figure 8. Comparison Between 8 kV IEC 61000-4-2 and 8 A and 16 A TLP Waveforms

# MECHANICAL CASE OUTLINE

## PACKAGE DIMENSIONS

ON Semiconductor®



SCALE 4:1

WLCSP5, 1.26x0.89  
CASE 567KK  
ISSUE O

DATE 10 JUL 2014

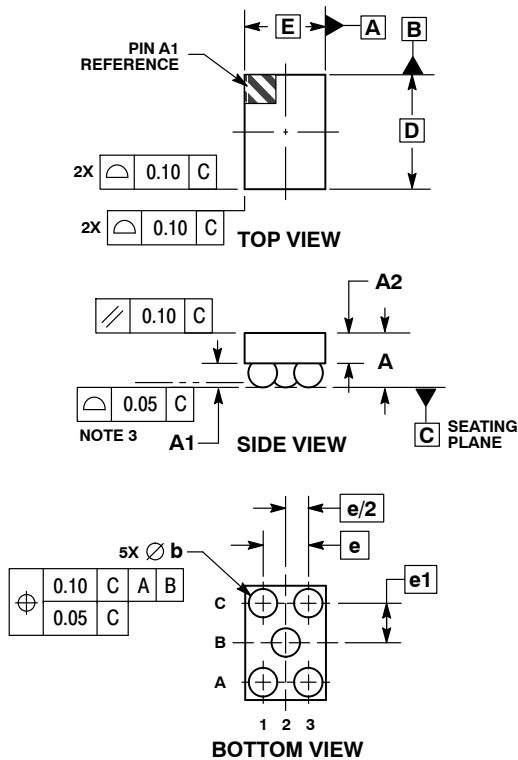

**NOTES:**

1. DIMENSIONING AND TOLERANCING PER ASME Y14.5M, 1994.
2. CONTROLLING DIMENSION: MILLIMETERS.
3. COPLANARITY APPLIES TO SPHERICAL CROWNS OF SOLDER BALLS.
4. DIMENSION b IS MEASURED AT THE MAXIMUM BALL DIAMETER PARALLEL TO DATUM C.

DIM	MILLIMETERS	
	MIN	MAX
A	0.56	0.72
A1	0.21	0.27
A2	0.38 REF	
b	0.29	0.35
D	1.26 BSC	
E	0.89 BSC	
e	0.50 BSC	
e1	0.435 BSC	

**GENERIC MARKING DIAGRAM\***



XX = Specific Device Code  
M = Date Code

\*This information is generic. Please refer to device data sheet for actual part marking. Pb-Free indicator, "G" or microdot "▪", may or may not be present.

**RECOMMENDED SOLDERING FOOTPRINT\***

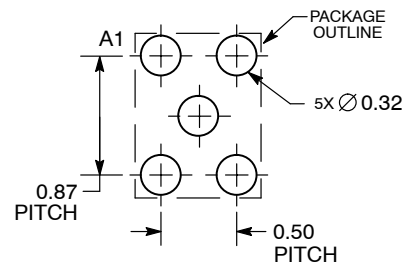

DIMENSIONS: MILLIMETERS

\*For additional information on our Pb-Free strategy and soldering details, please download the ON Semiconductor Soldering and Mounting Techniques Reference Manual, SOLDERRM/D.

<b>DOCUMENT NUMBER:</b>	<b>98AON88072F</b>	Electronic versions are uncontrolled except when accessed directly from the Document Repository. Printed versions are uncontrolled except when stamped "CONTROLLED COPY" in red.
<b>DESCRIPTION:</b>	<b>WLCSP5, 1.26X0.89</b>	<b>PAGE 1 OF 1</b>

ON Semiconductor and are trademarks of Semiconductor Components Industries, LLC dba ON Semiconductor or its subsidiaries in the United States and/or other countries. ON Semiconductor reserves the right to make changes without further notice to any products herein. ON Semiconductor makes no warranty, representation or guarantee regarding the suitability of its products for any particular purpose, nor does ON Semiconductor assume any liability arising out of the application or use of any product or circuit, and specifically disclaims any and all liability, including without limitation special, consequential or incidental damages. ON Semiconductor does not convey any license under its patent rights nor the rights of others.

**onsemi**, **Onsemi**, and other names, marks, and brands are registered and/or common law trademarks of Semiconductor Components Industries, LLC dba "**onsemi**" or its affiliates and/or subsidiaries in the United States and/or other countries. **onsemi** owns the rights to a number of patents, trademarks, copyrights, trade secrets, and other intellectual property. A listing of **onsemi**'s product/patent coverage may be accessed at [www.onsemi.com/site/pdf/Patent-Marking.pdf](http://www.onsemi.com/site/pdf/Patent-Marking.pdf). **onsemi** reserves the right to make changes at any time to any products or information herein, without notice. The information herein is provided "as-is" and **onsemi** makes no warranty, representation or guarantee regarding the accuracy of the information, product features, availability, functionality, or suitability of its products for any particular purpose, nor does **onsemi** assume any liability arising out of the application or use of any product or circuit, and specifically disclaims any and all liability, including without limitation special, consequential or incidental damages. Buyer is responsible for its products and applications using **onsemi** products, including compliance with all laws, regulations and safety requirements or standards, regardless of any support or applications information provided by **onsemi**. "Typical" parameters which may be provided in **onsemi** data sheets and/or specifications can and do vary in different applications and actual performance may vary over time. All operating parameters, including "Typicals" must be validated for each customer application by customer's technical experts. **onsemi** does not convey any license under any of its intellectual property rights nor the rights of others. **onsemi** products are not designed, intended, or authorized for use as a critical component in life support systems or any FDA Class 3 medical devices or medical devices with a same or similar classification in a foreign jurisdiction or any devices intended for implantation in the human body. Should Buyer purchase or use **onsemi** products for any such unintended or unauthorized application, Buyer shall indemnify and hold **onsemi** and its officers, employees, subsidiaries, affiliates, and distributors harmless against all claims, costs, damages, and expenses, and reasonable attorney fees arising out of, directly or indirectly, any claim of personal injury or death associated with such unintended or unauthorized use, even if such claim alleges that **onsemi** was negligent regarding the design or manufacture of the part. **onsemi** is an Equal Opportunity/Affirmative Action Employer. This literature is subject to all applicable copyright laws and is not for resale in any manner.

## ADDITIONAL INFORMATION

### TECHNICAL PUBLICATIONS:

Technical Library: [www.onsemi.com/design/resources/technical-documentation](http://www.onsemi.com/design/resources/technical-documentation)  
onsemi Website: [www.onsemi.com](http://www.onsemi.com)

### ONLINE SUPPORT: [www.onsemi.com/support](http://www.onsemi.com/support)

For additional information, please contact your local Sales Representative at [www.onsemi.com/support/sales](http://www.onsemi.com/support/sales)