











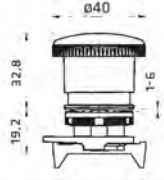

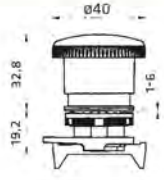
EMERGENCY PUSH BUTTONS Ø22 | EN ISO 13850

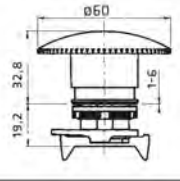
	TYPE	COLOUR INDEX	CODE	WEIGHT (gr)	MIN. PACK QUANTITY	SIZES
MUSHROOM OPERATOR Ø30 TWIST TO RELEASE	■	PPFN1R3N	42	10		
	TYPE	COLOUR INDEX	CODE	WEIGHT (gr)	MIN. PACK QUANTITY	SIZES
MUSHROOM OPERATOR WITH VISION Ø30 TWIST TO RELEASE	■	PPFN1R3S	44	10		
	TYPE	COLOUR INDEX	CODE	WEIGHT (gr)	MIN. PACK QUANTITY	SIZES
MUSHROOM OPERATOR Ø40 TWIST TO RELEASE	■	PPFN1R4N	44	10		
	TYPE	COLOUR INDEX	CODE	WEIGHT (gr)	MIN. PACK QUANTITY	SIZES
MUSHROOM OPERATOR WITH VISION Ø40 TWIST TO RELEASE	■	PPFN1R4S	46	10		
	TYPE	COLOUR INDEX	CODE	WEIGHT (gr)	MIN. PACK QUANTITY	SIZES
MUSHROOM OPERATOR Ø60 TWIST TO RELEASE	■	PPFN1R6N	50	10		
	TYPE	COLOUR INDEX	CODE	WEIGHT (gr)	MIN. PACK QUANTITY	SIZES
MUSHROOM OPERATOR WITH VISION Ø60 TWIST TO RELEASE	■	PPFN1R6S	52	10		

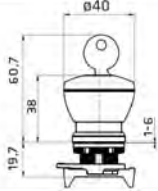
EMERGENCY PUSH BUTTONS Ø22 | EN ISO 13850

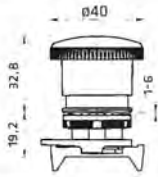
	TYPE	COLOUR INDEX	CODE	WEIGHT (gr)	MIN. PACK QUANTITY	SIZES
	MUSHROOM OPERATOR Ø40 WITH KEY RELEASE	■	PPFN1C4NX (non EN ISO 13850)	76	10	
	MUSHROOM OPERATOR Ø40 PUSH-PULL	■	PPFN1P4N	44	10	
	MUSHROOM OPERATOR Ø40 PUSH-PULL WITH VISION	■	PPFN1P4S	46	10	

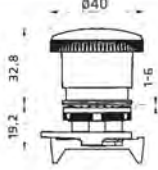
TECNICAL NOTES

- ☛ All operators comply with the relevant European standard.
- ☛ EN ISO 13850: Machine safety - Emergency stop operators, functional characteristics - Design guidelines.
- ☛ IEC/EN6097-5-1.
- ☛ Comply with the standard IEC/EN60204-1: Machine safety - Machine electrical circuits - General guidelines.
- ☛ The push buttons are designed with a load charge mechanism to ensure a reliable operation and stoppage, or blockage, in the activate position. The combination with positive switching NC ☛ contacts and the presence of the "status" indicator on some models, guarantee a high degree of reliability and effectiveness.



CONTACT BLOCKS | SPRING LOADED TERMINALS

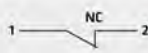
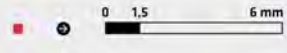
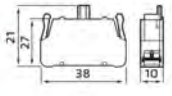
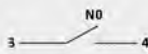
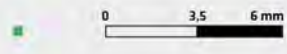

DESIGNATION	FUNCTION	CODE	SIZES
		PCW01	
		PCW10	

CONTACT BLOCKS | SCREW TERMINALS

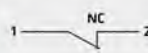
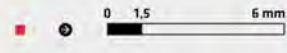
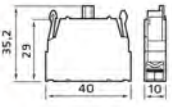
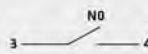

DESIGNATION	FUNCTION	CODE	SIZES
		PL004001	
		PL004002	

ACCESSORIES

CONTACTS SUPPORT



DESCRIPTION	CODE	DESCRIPTION	CODE
TO CONTACT ELEMENTS PL, PCW, PSC	PPELN8	TO FIVE CONTACT ELEMENTS PL, PCW, PSC	PPELN8-5

EMERGENCY STOP RING



DESCRIPTION	TEXT	CODE
Ø60 Made of Aluminium Yellow background Black letters. Weight 3,5 gr. Min. packing q.ty 10 pcs.	BLANK	PTE
	STOP - EMERGENZA	PTE/I
	EMERGENCY - STOP	PTE/A
	NOT - AUS	PTE/D

Available others texts on request, also in different languages.

TECHNICAL DATA | ELECTRICAL CHARACTERISTICS

CONTACT BLOCKS

EC/EN 60947-5-1 CHARACTERISTICS		PLO04001-PL004002							PCW01-PCW10 / PSC01-PSC10								
Rated insulation voltage Ui	V	690*							690*								
Rated impulse withstand voltage Uimp	kV	4*							4*								
Operating frequency	Hz	50/60*							50/60*								
Rated thermal current Ith	A	16*							16*								
Rated thermal current in enclosed Ithe	Hz	10*							10*								
RATED OPERATING CURRENT Ie:		PLO04001-PL004002							PCW01-PCW10 / PSC01-PSC10								
AC15: Alternate current	V	24	60	110	230	400	440	500	690	24	60	110	240	400	440	500	690
	A	16*	12	8	6	4,5	3,5	1*	1	16*	12	5	5*	4	4	4*	2*
DC13: Direct current	V	24	48	60	110	220				24	48	60	110	250			
	A	2*	1,2	0,85	0,4	0,25*				2	2*	1*	0,4	0,4*			
Conditional short circuit withstand current	A	1000*							1000*								
Fuse rating gG	500V	10A*							10A*								
Contact insulation resistance	mΩ	<25							<25								
Switching mechanism		Slow break double gap contacts							Slow break double gap contacts								
Contact duty		⊕ NC contact with positive opening							⊕ NC contact with positive opening								
Minimum tripping force		4N							4N								
Electrical life AC15	mil. cycles	1A/1,5 - 2A/0,5 - 3A/0,25							1A/1,5 - 2A/0,5 - 3A/0,25								
UL 508 CHARACTERISTICS		PLO04001-PL004002							PCW01-PCW10 / PSC01-PSC10								
General Use		10A-600V ac - 2,5A-125V dc							10A-600V ac - 2,5A-125V dc								
Heavy Duty (HD) category		A600-Q600							A600-Q600								
LAMP HOLDER		BA9s					BUILT-IN LED										
EC/EN 60947-5-1 CHARACTERISTICS		DIRECT PLO04007 PCWAD-PSCAD					LED PLO04.L. PCW.L.-PSC.L.										
Rated insulation voltage Ui	V	690*					400										
Rated operating voltage Ue	V	400* 300 1					AC/DC 12-24										
	V	-					AC/DC 48										
	V	-					AC/DC 110										
	V	-					AC 220										
Max rated power	W	2,4* 2,5 1					-										
Power supply		AC/DC					-										
Lamp fixing system		BA9s					-										

TECHNICAL DATA | ELECTRICAL CHARACTERISTICS

STANDARD CONFORMITY		UL - IMG - CCC - EAC - R.I.N.A
Approvals		IEC/EN60947-5-1, UL508
Protection class	EN 60529	IP65: Buttons and switches, joysticks, single-lamp IP66/IP67/IP69K: Mushroom emergency EN ISO 13850
	Conforms to UL50	IP40: Multi-function push buttons
	EN 60529	IP66: Buttons with protection caps Type 1
		IP65: Control stations, enclosures
		IP66: Mushroom, Push button Ø90
		IP20: Contacts PCW.,PL.
		IP00:PSC.
Material Group	EN60947-1	II
Pollution Grade	EN60947-1	3
Flammability	UL94	VO: live parts
Ambient Temperature	°C	Operating: -25 +70
	°C	Storage: -30 +70
Climate Protection	IEC68 part 2-3	Hot damp
	IEC68 part 2-30	Unsettled Hot damp
Terminals referencing		EN50013
Terminals:		
Dimensions		A2
Screw		M3,5
Torque		1,2 Nm - EN60947-1 - 12 lb.in. UL508
Capacity:		
Solid and flexible conductors	n° 1 min/max mm ²	1/2,5 screw terminals, 0,5-2,5 spring loaded terminals
	n° 2 min/max mm ²	1/2,5 screw terminals, 0,5-2,5 spring loaded terminals
	AWG	20-12 screw terminals, spring loaded terminals
Mechanical life:		
Mushroom operators and standard		3
Push buttons with colour cap	mil./operations	
Standard push buttons with lens cap		1
Latched push buttons with colour cap		1
Standard rotary switches		1
Rotary switches with lens, latched push button with lens cap, joystick		0,5
Emergency stop push buttons with release		0,3

ASSEMBLY INSTRUCTIONS

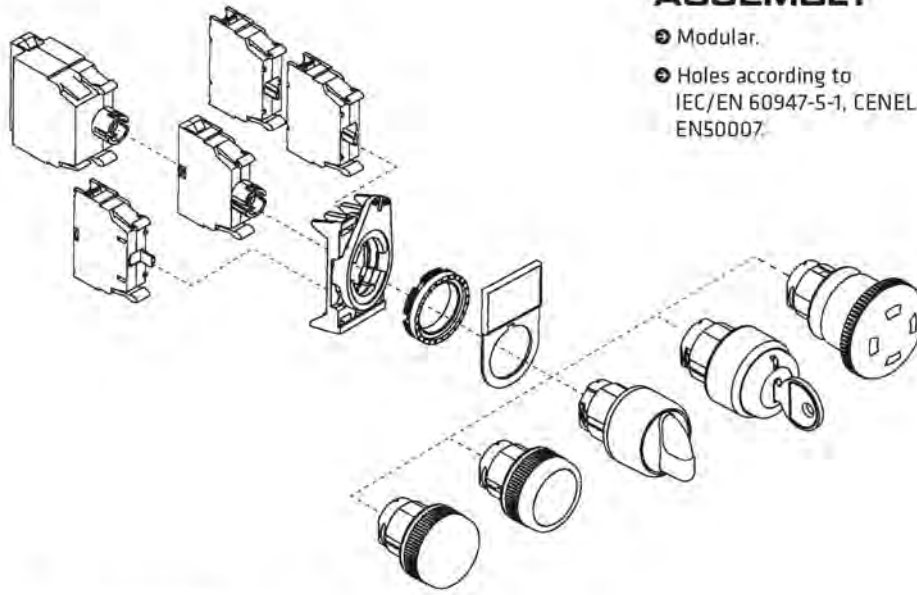

ASSEMBLY

- Modular.
- Holes according to IEC/EN 60947-5-1, CENELEC EN50007.

CENELEC EN50007

- Panel thickness from 1 up to 6 mm.

• If not required, lock nuts can be easily removed by means of a screwdriver.

