

STN161XXXUXXX

TVS Diode ESD suppressor

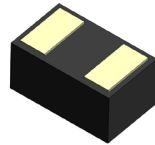

Product features

- Protects one I/O or power line
- Low clamping voltage
- Low leakage current
- Meets moisture sensitivity level (MSL) 3
- Molding compound flammability rating: UL 94V-0
- Termination finish: Tin

Applications

- Cellular phones
- Wearables
- Portable electronics
- Laptop/notebook computers
- Digital cameras

Environmental compliance and general specifications

- IEC61000-4-2 (ESD)
 - Up to ± 30 kV (air)
 - Up to ± 30 kV (contact)
- IEC61000-4-5 (Lightning) Up to 110 A (8/20 μ s)



Ordering part number

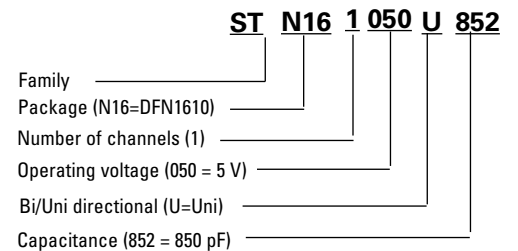

Pin out/functional diagram



DFN1610-2L

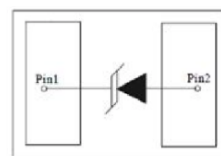

PIN Configuration

Absolute maximum ratings

(+25 °C, RH=45%-75%, unless otherwise noted)

Parameter	Symbol	Value	Unit
STN161XXXUXXX			
Peak pulse power dissipation on 8/20 μs waveform	P_{pp}	2000	W
ESD per IEC 61000-4-2 (Air)	V_{ESD}	+/-30	kV
ESD per IEC 61000-4-2 (Contact)		+/-30	
Lead soldering temperature	T_L	+260 (10 seconds)	°C
Operating junction temperature range	T_J	-55 to +125	°C
Storage temperature range	T_{STG}	-55 to +150	°C

Electrical characteristics

(+25 °C)

STN161050U852

Parameter	Test condition	Minimum	Typical	Maximum	Symbol (Units)
Reverse working voltage	-	-	-	5.0	V_{RWM} (V)
Reverse breakdown voltage	$I_T = 1$ mA	6	7	8	V_{BR} (V)
Reverse leakage current	$V_{RWM} = 5$ V	-	-	1	I_R (μA)
Peak pulse current	$t_p = 8/20$ μs	-	-	110	I_{pp} (A)
Clamping voltage	$I_{pp} = 50$ A, $t_p = 8/20$ μs	-	11	14	V_C (V)
	$I_{pp} = 80$ A, $t_p = 8/20$ μs	-	13	15	V_C (V)
	$I_{pp} = 110$ A, $t_p = 8/20$ μs	-	14	17	V_C (V)
Junction capacitance	$V_{RWM} = 0$ V, $f = 1$ MHz	-	850	1050	C_J (pF)

STN161070U722

Parameter	Test condition	Minimum	Typical	Maximum	Symbol (Units)
Reverse working voltage	-	-	-	7.0	V_{RWM} (V)
Reverse breakdown voltage	$I_T = 1$ mA	7.5	8	9	V_{BR} (V)
Reverse leakage current	$V_{RWM} = 7$ V	-	-	1	I_R (μA)
Forward voltage	$I_F = 10$ mA	0.6	-	1	V_F
Peak pulse current	$t_p = 8/20$ μs	-	-	100	I_{pp} (A)
Clamping voltage	$I_{pp} = 50$ A, $t_p = 8/20$ μs	-	12	15	V_C (V)
	$I_{pp} = 100$ A, $t_p = 8/20$ μs	-	15	18	V_C (V)
Junction capacitance	$V_{RWM} = 0$ V, $f = 1$ MHz	-	720	900	C_J (pF)

STN161090U602

Parameter	Test condition	Minimum	Typical	Maximum	Symbol (Units)
Reverse working voltage	-	-	-	9.0	V_{RWM} (V)
Reverse breakdown voltage	$I_T = 1$ mA	9.5	10.5	12.5	V_{BR} (V)
Reverse leakage current	$V_{RWM} = 9$ V	-	-	1	I_R (μ A)
Forward voltage	$I_T = 10$ mA	0.6	-	1.0	V_F
Peak pulse current	$t_p = 8/20$ μ s	-	-	90	I_{pp} (A)
Clamping voltage	$I_{pp} = 40$ A, $t_p = 8/20$ μ s	-	14	17	V_C (V)
	$I_{pp} = 50$ A, $t_p = 8/20$ μ s	-	15	19	V_C (V)
	$I_{pp} = 90$ A, $t_p = 8/20$ μ s	-	18	22	V_C (V)
	$I_{pp} = 90$ A, $t_p = 8/20$ μ s	-	18	22	V_C (V)
Junction capacitance	$V_{RWM} = 0$ V, $f = 1$ MHz	-	600	750	C_J (pF)

STN161120U372

Parameter	Test condition	Minimum	Typical	Maximum	Symbol (Units)
Reverse working voltage	-	-	-	12	V_{RWM} (V)
Reverse breakdown voltage	$I_T = 1$ mA	13.3	14.4	17	V_{BR} (V)
Reverse leakage current	$V_{RWM} = 12$ V	-	-	1	I_R (μ A)
Peak pulse current	$t_p = 8/20$ μ s	-	-	70	I_{pp} (A)
Clamping voltage	$I_{pp} = 20$ A, $t_p = 8/20$ μ s	-	16	19	V_C (V)
	$I_{pp} = 40$ A, $t_p = 8/20$ μ s	-	20	24	V_C (V)
	$I_{pp} = 70$ A, $t_p = 8/20$ μ s	-	22	28	V_C (V)
	$I_{pp} = 70$ A, $t_p = 8/20$ μ s	-	22	28	V_C (V)
Junction capacitance	$V_{RWM} = 0$ V, $f = 1$ MHz	-	370	450	C_J (pF)

STN161150U332

Parameter	Test condition	Minimum	Typical	Maximum	Symbol (Units)
Reverse working voltage	-	-	-	15	V_{RWM} (V)
Reverse breakdown voltage	$I_T = 1$ mA	16	17.2	20	V_{BR} (V)
Reverse leakage current	$V_{RWM} = 12$ V	-	-	1	I_R (μ A)
Peak pulse current	$t_p = 8/20$ μ s	-	-	55	I_{pp} (A)
Clamping voltage	$I_{pp} = 25$ A, $t_p = 8/20$ μ s	-	22	25	V_C (V)
	$I_{pp} = 50$ A, $t_p = 8/20$ μ s	-	26	28	V_C (V)
	$I_{pp} = 55$ A, $t_p = 8/20$ μ s	-	27	30	V_C (V)
	$I_{pp} = 55$ A, $t_p = 8/20$ μ s	-	27	30	V_C (V)
Junction capacitance	$V_{RWM} = 0$ V, $f = 1$ MHz	-	330	450	C_J (pF)

Mechanical parameters, pad layout- mm

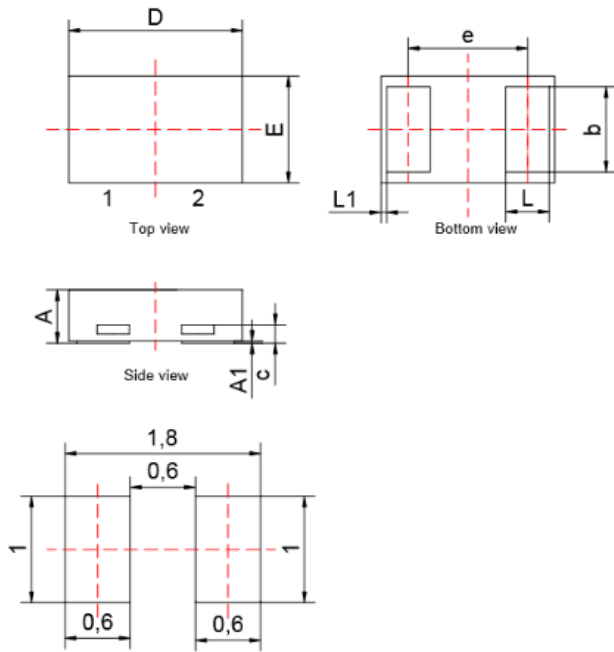

Recommended Soldering Footprint

Dimension	Minimum	Typical	Maximum
A	0.45	0.50	0.55
A1	0	0.02	0.05
b	0.85	0.90	0.95
c	0.08	0.12	0.18
D	1.55	1.60	1.65
e		1.1 BSC	
E	0.95	1.00	1.05
L	0.35	0.40	0.45
L1		0.06 BSC	

Part marking

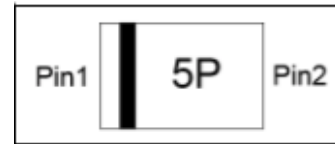

(STN161050U852)

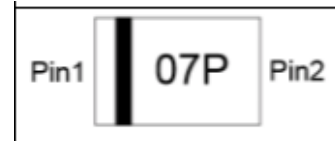

(STN161070U722)

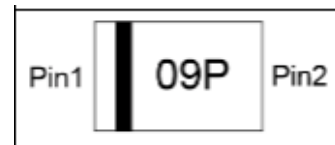

(STN161090U602)

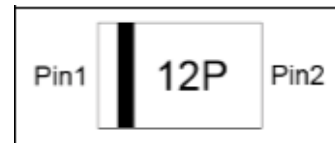

(STN161120U372)

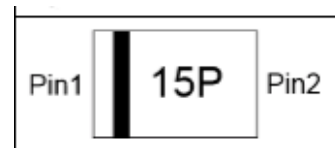

(STN161150U332)

Packaging information mm/inches

Drawing not to scale.

Supplied in tape and reel packaging, 3,000 parts per 7" diameter reel (EIA-481 compliant)

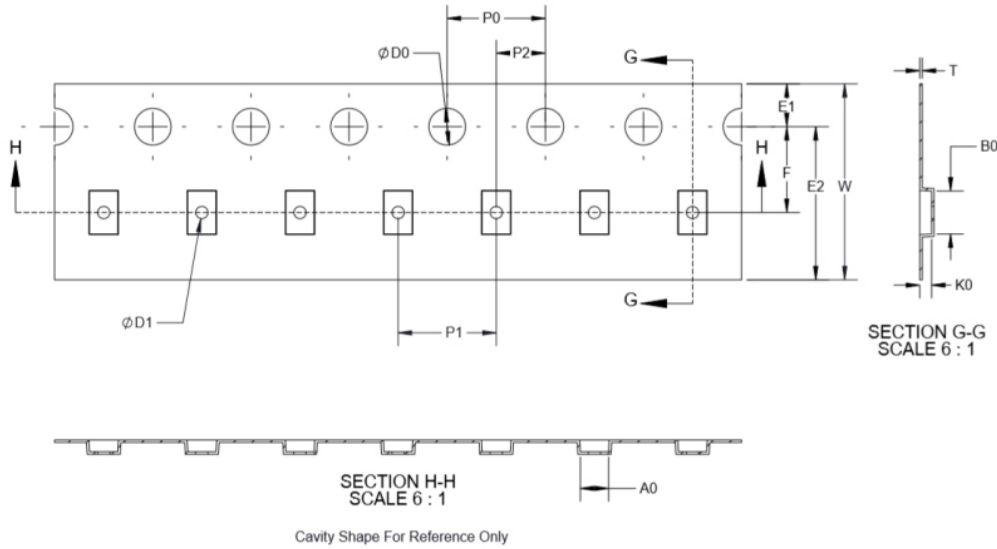

W	8 +0.2/-0.1
F	3.5±0.05
E1	1.75±0.10
E2	N/A
P0	4±0.10
P1	4±0.10
P2	2±0.05
ØD0	1.55±0.10
ØD1	0.6 +0.10/-0
A0	1.15±0.05
B0	1.75±0.05
K0	0.63±0.05
T	0.2±0.03

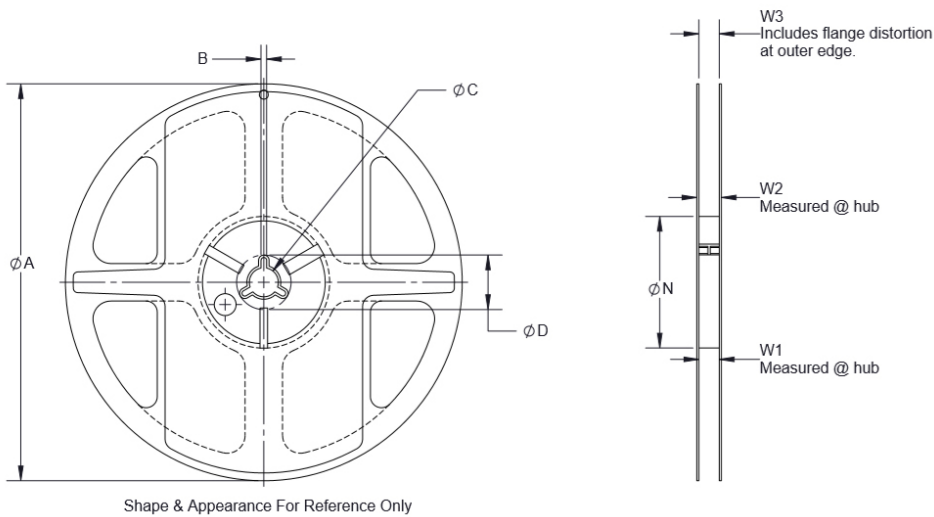

A	178
B	N/A
C	13
D	N/A
N	54.40
W1	9.50
W2	12.30
W3	N/A

Ratings and V-I characteristic curves (+25 °C unless otherwise noted)

V- I curve characteristics (uni-directional)

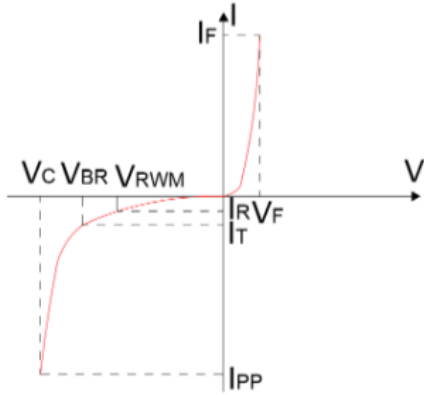

Pulse waveform (8/20 μs)

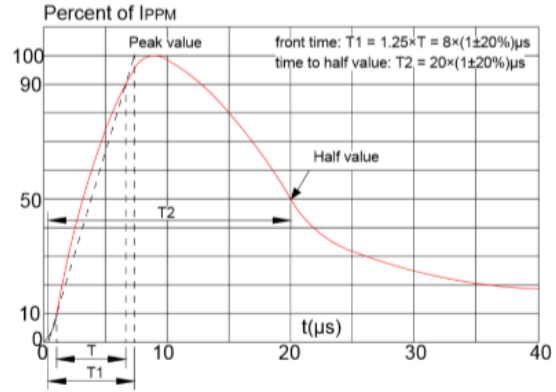

Pulse derating curve

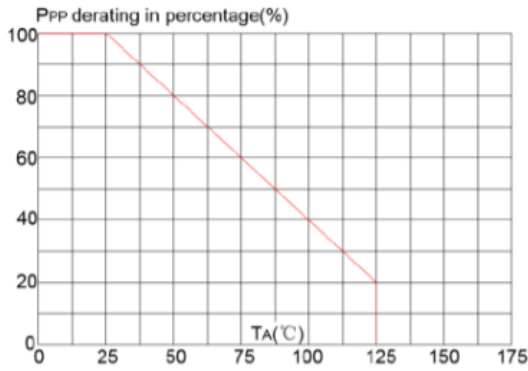

ESD waveform

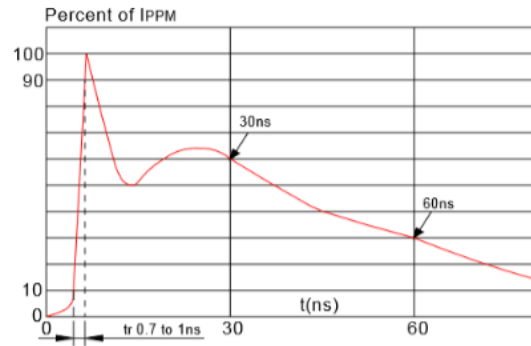

Solder reflow profile

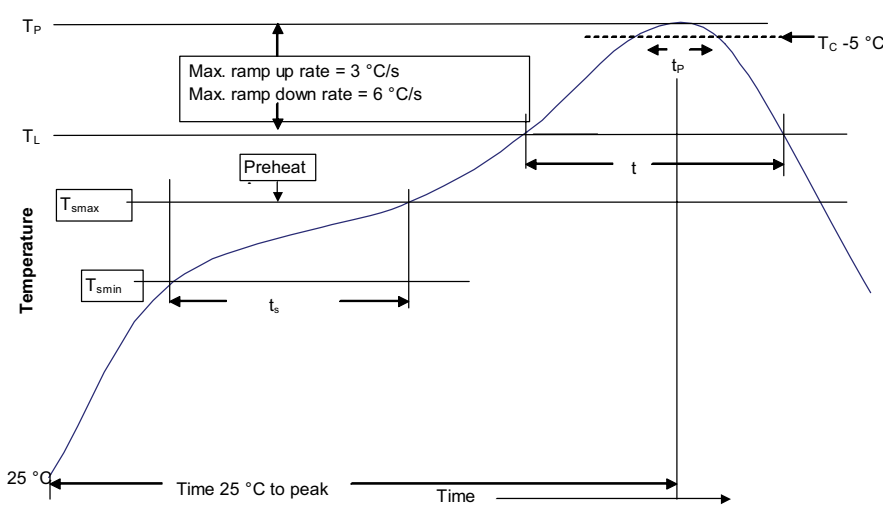

Table 1 - Standard SnPb solder (T_C)

Package thickness	Volume mm ³ <350	Volume mm ³ ≥350
<2.5 mm	235 °C	220 °C
≥2.5 mm	220 °C	220 °C

Table 2 - Lead (Pb) free solder (T_C)

Package thickness	Volume mm ³ <350	Volume mm ³ 350 - 2000	Volume mm ³ >2000
<1.6 mm	260 °C	260 °C	260 °C
1.6 – 2.5 mm	260 °C	250 °C	245 °C
>2.5 mm	250 °C	245 °C	245 °C

Reference J-STD-020

Profile feature	Standard SnPb solder	Lead (Pb) free solder
Preheat and soak		
• Temperature min. (T _{smin})	100 °C	150 °C
• Temperature max. (T _{smax})	150 °C	200 °C
• Time (T _{smin} to T _{smax}) (t _s)	60-120 seconds	60-120 seconds
Ramp up rate T _L to T _p	3 °C/ second max.	3 °C/ second max.
Liquidous temperature (T _L)	183 °C	217 °C
Time (t _L) maintained above T _L	60-150 seconds	60-150 seconds
Peak package body temperature (T _p)*	Table 1	Table 2
Time (t _p)* within 5 °C of the specified classification temperature (T _C)	20 seconds*	30 seconds*
Ramp-down rate (T _p to T _L)	6 °C/ second max.	6 °C/ second max.
Time 25 °C to peak temperature	6 minutes max.	8 minutes max.

* Tolerance for peak profile temperature (T_p) is defined as a supplier minimum and a user maximum.

Life Support Policy: Eaton does not authorize the use of any of its products for use in life support devices or systems without the express written approval of an officer of the Company. Life support systems are devices which support or sustain life, and whose failure to perform, when properly used in accordance with instructions for use provided in the labeling, can be reasonably expected to result in significant injury to the user.

Eaton reserves the right, without notice, to change design or construction of any products and to discontinue or limit distribution of any products. Eaton also reserves the right to change or update, without notice, any technical information contained in this bulletin.

Eaton
Electronics Division
1000 Eaton Boulevard
Cleveland, OH 44122
United States
Eaton.com/electronics

© 2021 Eaton
All Rights Reserved
Printed in USA
Publication No. 11134
March 2021

Eaton is a registered trademark.
All other trademarks are property of their respective owners.

Follow us on social media to get the latest product and support information.

