

MOVS2825

Surface mount metal oxide varistor

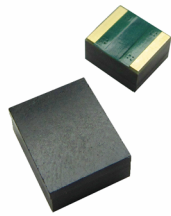

Product features

- Surface mount metal oxide varistor (MOV)
- 2825 (7264 metric) package size
- High transient current capability
- Plastic package meets UL 94 V-0
- Meets UL1449 4th edition
- Moisture sensitivity level (MSL): 1

Applications

- Power supply
- Home appliance
- Industrial equipment
- Telecommunication or telephone system
- Vac driven & COB LED lighting

Agency information

- cURus recognized:
File: E340782, Guide VZCA2 and VZCA8



Environmental compliance



Ordering part number

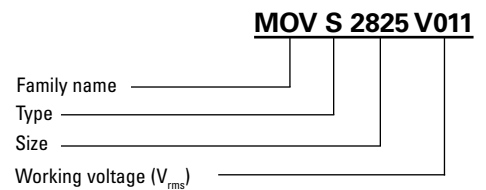

Electrical characteristics (+25 °C)

Part number	Working voltage		Varistor voltage @ 1 mAdc V_V (V) typical	Leakage current @ V_V * 80% (at initial state) IL (μ A) maximum	Clamping voltage 8/20 μ s V_C (V) maximum	Peak current 8/20 μ s i_{max} (A) maximum	Maximum energy (J) 10/1000 μ s	Rated power (W)	Typical capaci- tance (pF) 1.0 kHz	Component thickness T (mm) ± 0.3
	V_{RMS} (V) maximum	V_{DC} (V) maximum								
MOV52825V011	11	14	16.2-19.8	50	40 (1 A)	150	0.4	0.01	2100	3.2
MOV52825V014	14	18	19.8-24.2	50	48 (1 A)	150	0.5	0.01	1700	3.2
MOV52825V017	17	22	24.3-29.7	50	60 (1 A)	150	0.6	0.01	1400	3.2
MOV52825V020	20	26	29.7-36.3	50	73 (1 A)	150	0.8	0.01	1200	4.2
MOV52825V025	25	31	35.1-42.9	50	80 (1 A)	150	0.9	0.01	550	4.2
MOV52825V030	30	38	42.3-51.7	50	104 (1 A)	150	1.1	0.01	640	4.2
MOV52825V035	35	45	50.4-61.6	50	123 (1 A)	150	1.3	0.01	420	4.2
MOV52825V040	40	56	61.2-74.8	50	145 (1 A)	150	1.6	0.01	350	4.2
MOV52825V050	50	66	73.8-90.2	50	150 (5 A)	400	2.5	0.1	260	3.2
MOV52825V060	60	85	90-110	50	175 (5 A)	400	3.0	0.1	240	3.2
MOV52825V075	75	102	108-132	50	210 (5 A)	400	4.0	0.1	185	4.2
MOV52825V095	95	127	135-165	50	260 (5 A)	400	4.1	0.1	175	4.2
MOV52825V120	120	160	170-207	50	320 (5 A)	400	4.9	0.1	95	4.2
MOV52825V130	130	175	185-225	50	355 (5 A)	400	6.5	0.1	90	4.2
MOV52825V140	140	180	198-242	50	380 (5 A)	400	7.5	0.1	85	4.2
MOV52825V150	150	200	216-264	50	415 (5 A)	400	8.0	0.1	80	4.2
MOV52825V180	180	230	255-311	50	475 (5 A)	400	8.5	0.1	70	4.2
MOV52825V195	195	250	270-330	50	520 (5 A)	400	9	0.1	65	4.2
MOV52825V210	210	275	297-363	50	570 (5 A)	400	9.5	0.1	65	4.2
MOV52825V230	230	300	324-396	50	620 (5 A)	400	10	0.1	60	4.2
MOV52825V250	250	330	351-429	50	675 (5 A)	400	12	0.1	55	4.2
MOV52825V275	275	370	387-473	50	745 (5 A)	400	13	0.1	50	5.6
MOV52825V300	300	385	423-517	50	810 (5 A)	400	15	0.1	45	5.6
MOV52825V320	320	420	459-561	50	845 (5 A)	400	16	0.1	45	5.6
MOV52825V360	360	470	522-638	50	920 (5 A)	400	16.5	0.1	40	5.6
MOV52825V390	390	505	558-682	50	1025 (5 A)	400	21	0.1	40	5.6
MOV52825V420	420	560	612-748	50	1120 (5 A)	400	22	0.1	35	5.6

V_{RMS}/V_{DC} – Maximum operating voltage the varistor can maintain
 V_V – Voltage across the device measured at 1 mA DC current. Equivalent to V_b , “Breakdown Voltage”.
 V_C – Maximum peak voltage across the varistor measured at 8/20 μ s waveform.
 i_{max} – Maximum peak current which may be applied with 8/20 μ s waveform without device failure

Dimensions- mm
Drawing not to scale

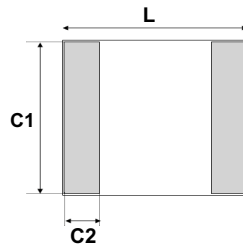
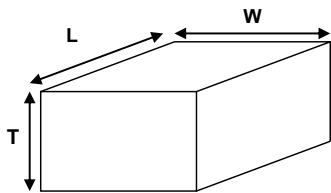

Bottom view

Dimension	Value	Note
L	7.2 ± 0.2	
W	6.4 ± 0.2	
T	3.2 ± 0.3 4.2 ± 0.3 5.6 ± 0.3	Refer to Electrical specifications table on pg 2
C1	5.8 ± 0.3	
C2	1.1 ± 0.3	

Recommended pad layout

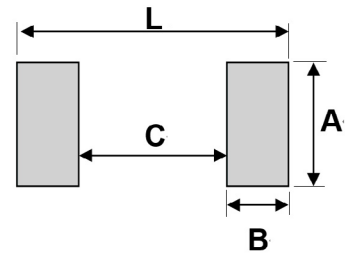

Dimension	Value
A	6.8
B	1.5
C	4.6
L	7.6

Part marking

Part number	Marking	Part number	Marking
MOVS2825V011	A	MOVS2825V140	O
MOVS2825V014	B	MOVS2825V150	P
MOVS2825V017	C	MOVS2825V180	Q
MOVS2825V020	D	MOVS2825V195	R
MOVS2825V025	E	MOVS2825V210	S
MOVS2825V030	F	MOVS2825V230	T
MOVS2825V035	G	MOVS2825V250	U
MOVS2825V040	H	MOVS2825V275	V
MOVS2825V050	I	MOVS2825V300	W
MOVS2825V060	J	MOVS2825V320	X
MOVS2825V075	K	MOVS2825V360	Y
MOVS2825V095	L	MOVS2825V390	Z
MOVS2825V120	M	MOVS2825V420	2
MOVS2825V130	N		

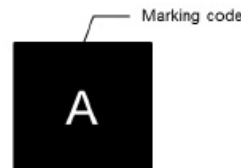

General specifications

Operating temperature: -40 °C to +85 °C

Storage temperature (on board): -40 °C to +85 °C

Solderability: +245 ± 5 °C, 3 ± 1 second

Solder leach resistance: +260 ± 5 °C, 10 ± 1 second

Packaging information - mm

900 pieces per reel for MOVS2825, T = 5.6 mm

1100 pieces per reel for MOVS2825, T = 4.2 mm

1400 pieces per reel for MOVS2825, T = 3.2 mm

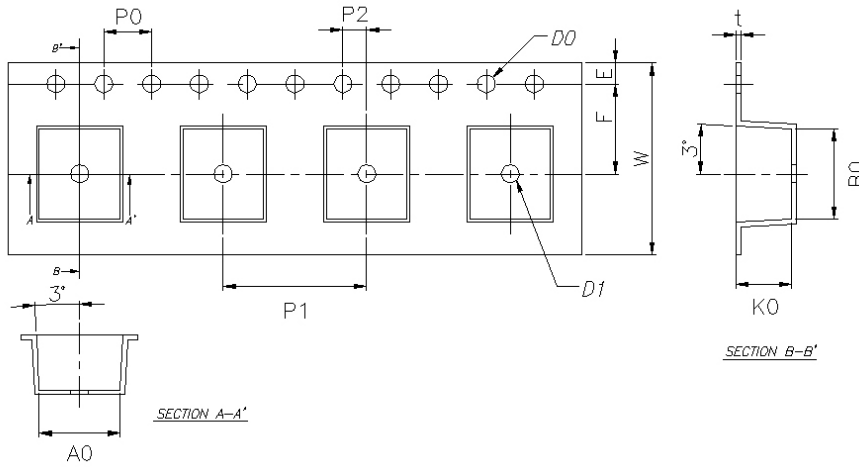

Dimension	Value
W	16.00 ± 0.30
E	1.75 ± 0.10
F	7.50 ± 0.15
D0	1.50 ± 0.10/-0.00
D1	1.50 ± 0.10/-0.00
P0	4.00 ± 0.10
P0 x10	40.0 ± 0.20
t	0.50 ± 0.05
A0	6.75 ± 0.15/-0.05
B0	7.55 ± 0.15/-0.05
K0	6.20 maximum
P1	12.00 ± 0.10
P2	2.00 ± 0.15

Reel dimension - mm

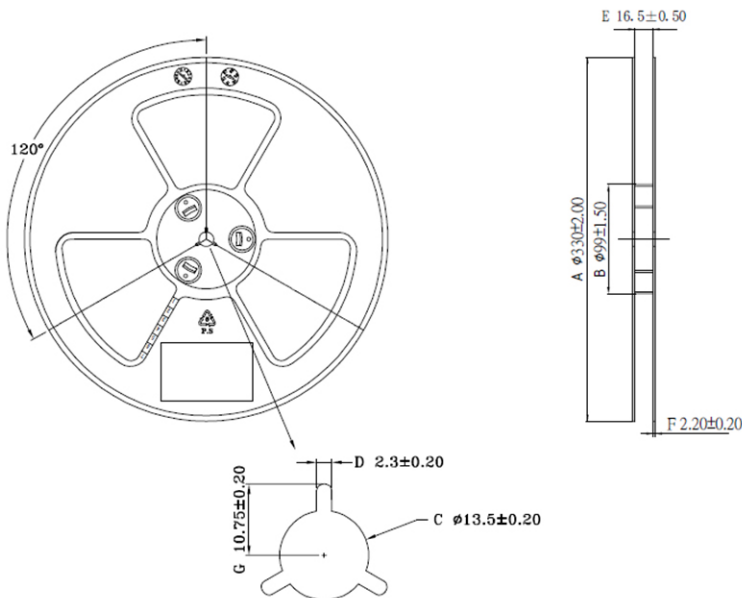

Dimension	Value
A	330 ± 2.00
B	99 ± 1.50
C	13.50 ± 0.20
D	2.30 ± 0.20
E	16.50 ± 0.50
F	2.20 ± 0.20
G	10.75 ± 0.20

Peak current, energy and power derating curve

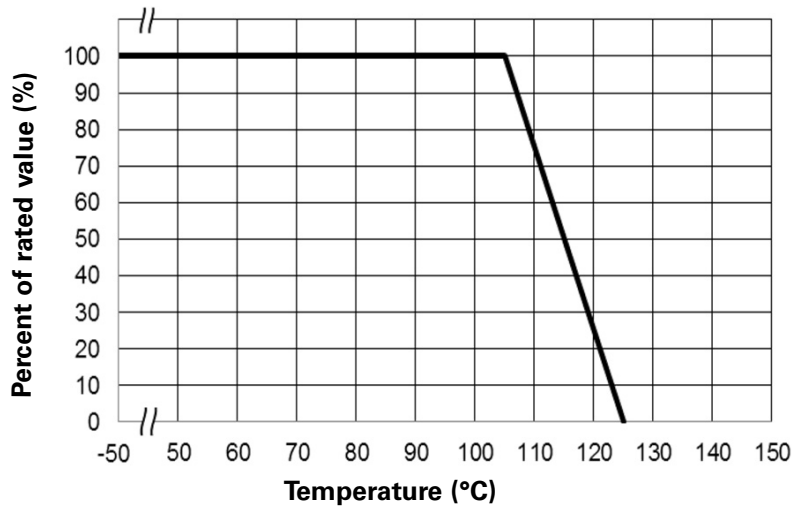

Voltage vs current (V-I) curves

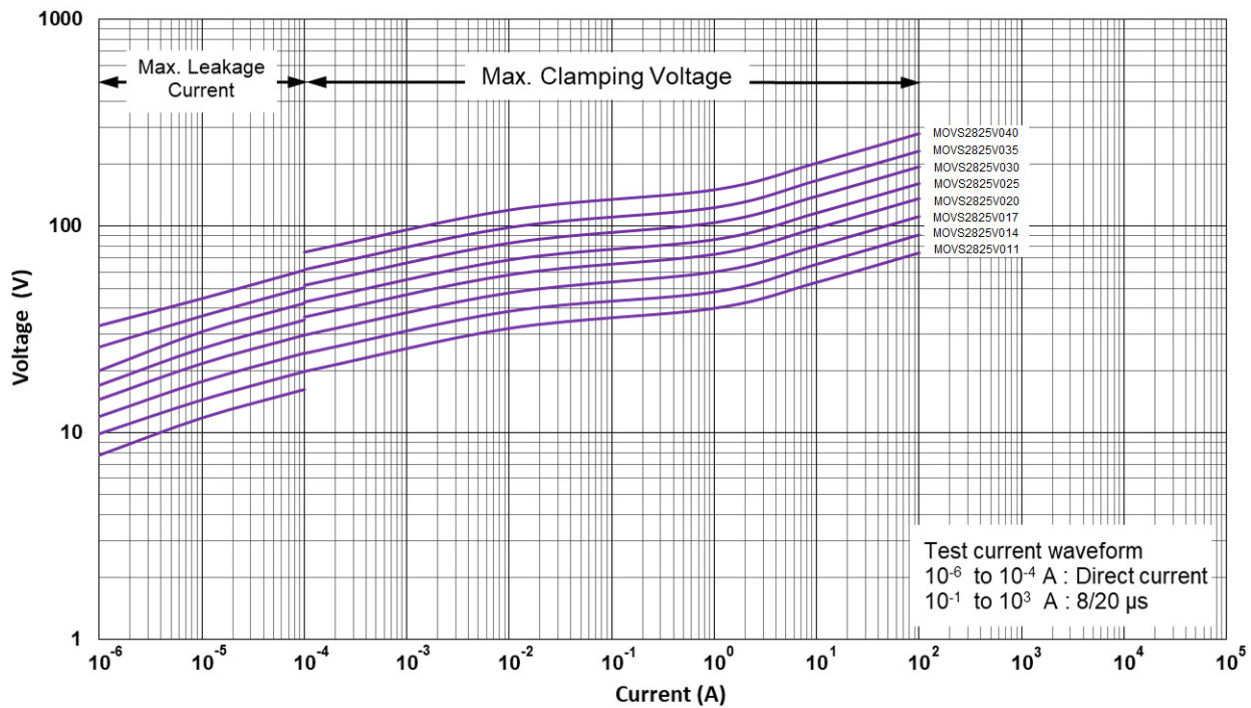

Voltage vs current (V-I) curves (continued)

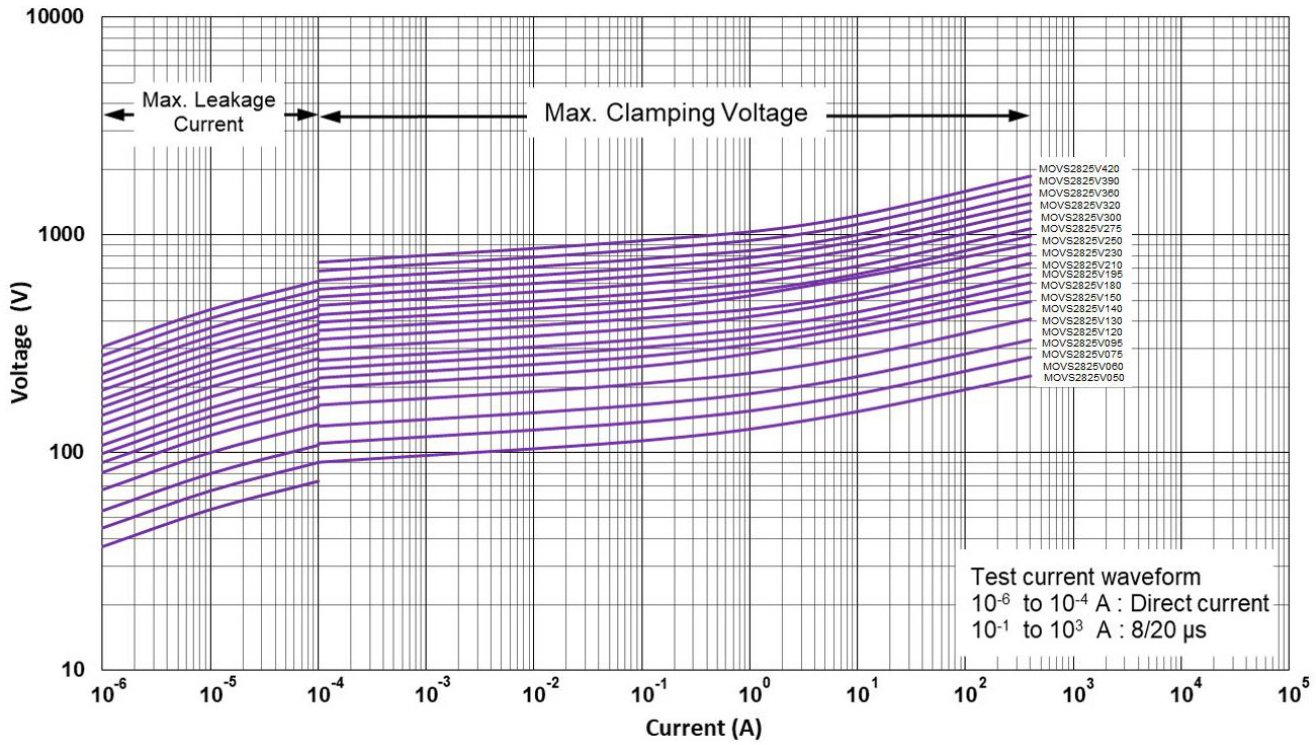

Pulse rating curve

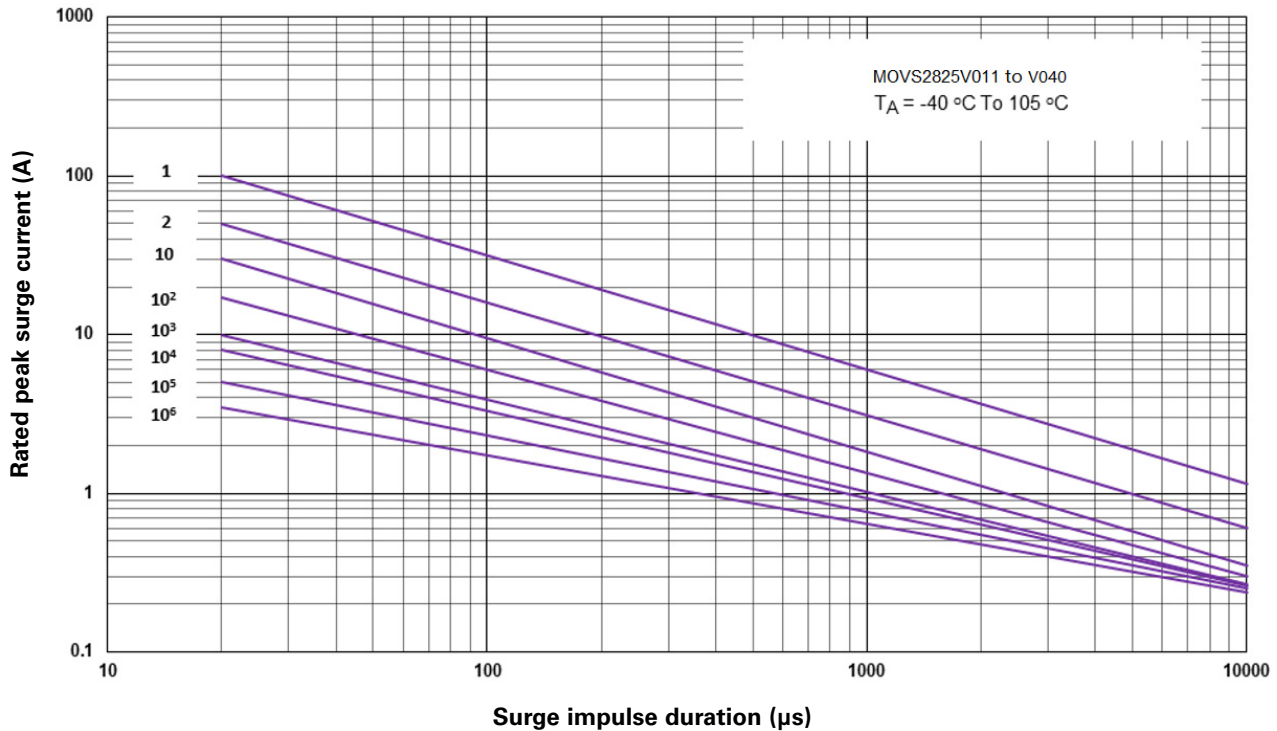

Pulse rating curve (continued)

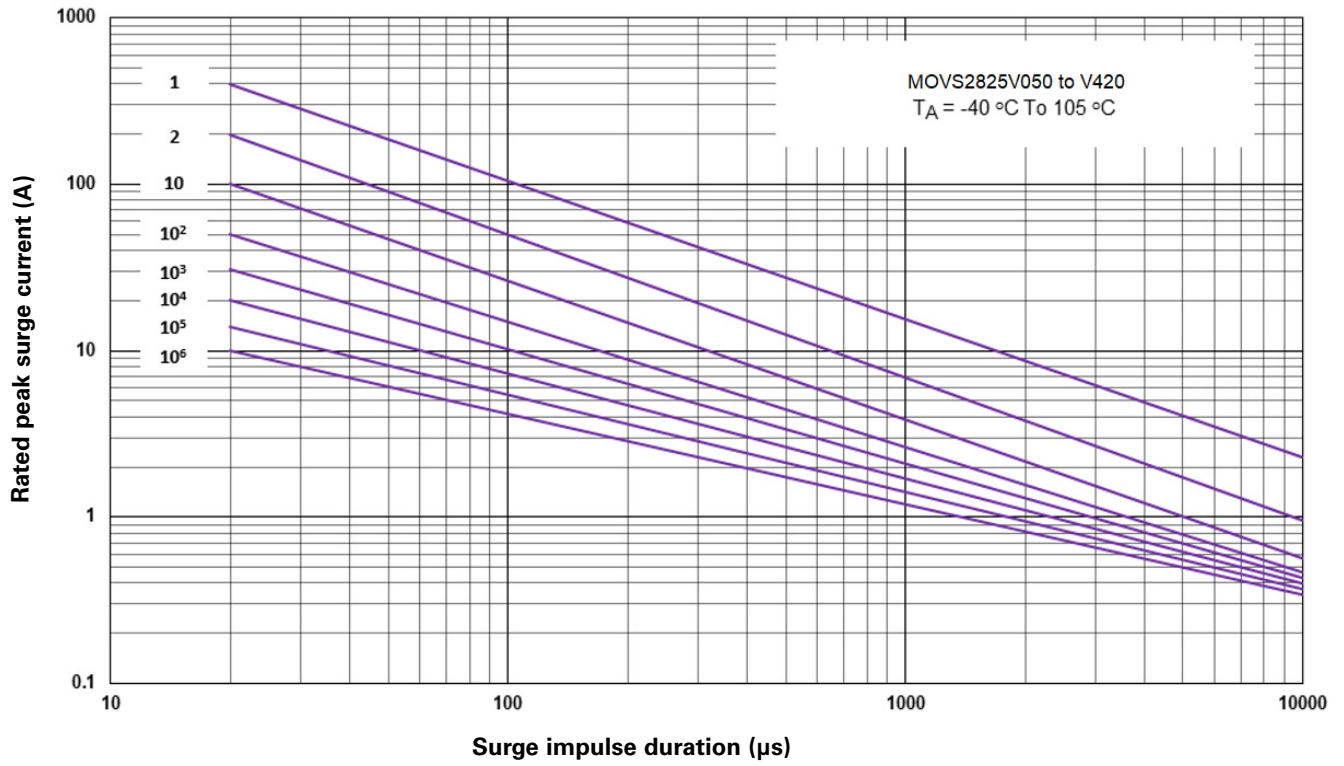

Solder reflow profile

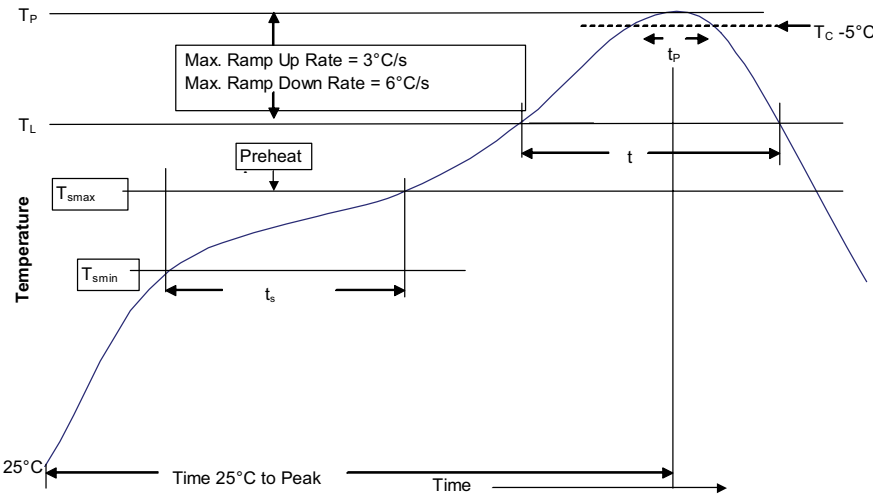

Table 1 - Standard SnPb solder (T_C)

Package thickness	Volume mm ³ <350	Volume mm ³ ≥350
<2.5 mm	235 °C	220 °C
≥2.5 mm	220 °C	220 °C

Table 2 - Lead (Pb) free solder (T_C)

Package thickness	Volume mm ³ <350	Volume mm ³ 350 - 2000	Volume mm ³ >2000
<1.6 mm	260 °C	260 °C	260 °C
1.6 – 2.5 mm	260 °C	250 °C	245 °C
>2.5 mm	250 °C	245 °C	245 °C

Reference J-STD-020

Profile feature	Standard SnPb solder	Lead (Pb) free solder
Preheat and soak	<ul style="list-style-type: none"> Temperature min. (T_{smin}) Temperature max. (T_{smax}) Time (T_{smin} to T_{smax}) (t_s) 	<ul style="list-style-type: none"> 100 °C 150 °C 60-120 seconds
Ramp up rate T _L to T _p	3 °C/ second max.	3 °C/ second max.
Liquidous temperature (T _L)	183 °C	217 °C
Time (t _L) maintained above T _L	60-150 seconds	60-150 seconds
Peak package body temperature (T _p)*	Table 1	Table 2
Time (t _p)* within 5 °C of the specified classification temperature (T _C)	20 seconds*	30 seconds*
Ramp-down rate (T _p to T _L)	6 °C/ second max.	6 °C/ second max.
Time 25 °C to peak temperature	6 minutes max.	8 minutes max.

* Tolerance for peak profile temperature (T_p) is defined as a supplier minimum and a user maximum.

Life Support Policy: Eaton does not authorize the use of any of its products for use in life support devices or systems without the express written approval of an officer of the Company. Life support systems are devices which support or sustain life, and whose failure to perform, when properly used in accordance with instructions for use provided in the labeling, can be reasonably expected to result in significant injury to the user.

Eaton reserves the right, without notice, to change design or construction of any products and to discontinue or limit distribution of any products. Eaton also reserves the right to change or update, without notice, any technical information contained in this bulletin.

Eaton
Electronics Division
1000 Eaton Boulevard
Cleveland, OH 44122
United States
Eaton.com/electronics

© 2022 Eaton
All Rights Reserved
Printed in USA
Publication No. ELX1005
August 2022

Eaton is a registered trademark.
All other trademarks are property of their respective owners.

Follow us on social media to get the latest product and support information.

