



Contents

INTRODUCTION 3

IMPORTANT NOTICE 3

DESCRIPTION 3

SPECIFICATION 4

TEST SET-UP 4

OPERATION NOTES 5

TEST RESULTS 6-10

SCHEMATIC 11

LAYOUT 11

COMPONENT LIST 11

Introduction

This document describes the operations of evaluation kits (EVK) concerning the Eaton’s EPM DC-DC non-isolated converter product. The EVK includes test points for all main points where probing is necessary for evaluation. The EVK supports many options for Eaton’s product configuration. Using these options, the user is allowed to test all desired electrical specifications. This guide describes the test configurations and typical equipment setup. The typical input and output waveforms are also presented.

Important notice

- Please read the product datasheet and EVK user guide before using the EVK.
- Please do not remove the product from the EVK.
- This product is an ESD sensitive component and should be tested in an ESD protected area.
- The EVK is designed to operate in clean and dust-free office or laboratory. The EVK should be protected from sunlight and sources of heat, and making sure air is flowing across the tool. Please keep it away from vibration or strong electromagnetic fields generated by electrical equipment.
- When connecting and disconnecting the power interface, please turn off the power supply to avoid accidental short circuits causing injury.
- The power connection must avoid reverse voltage application.
- During the test, the electrical rating should be kept within the range specified in the data sheet.

Description

This EVK supports user test electrical performance of Eaton’s DC-DC non-isolated converter part numbers EPM78V1-01R8-01R0R, EPM78V2-03R3-01R0R, EPM78V2-05R0-01R0R, EPM78V2-06R5-01R0R, EPM78V2-12R0-01R0R, and EPM78V2-15R0-01R0R.

Figure 1 shows the EPM78-EVK and function outline. This EVK is made up of the following functions, first is the input and output connectors, and the following is EMI Class A/B protection circuit. This EVK is combined EPM78 complete family products in a PCB.



Figure 1. EPM78-EVK

Specifications

Table 1 shows the EPM78-EVK general performance specifications. The EPM78-EVK can deliver up to 1 A of output current and with a wide DC input. The voltages can step down to 1.8 Vdc to 15 Vdc. The modules can achieve high efficiency up to 94.5% , wide operation temperature from -40 °C to +85 °C, and has short circuit protection. Please refer to the product data sheet for the detailed specifications [EPM78Vx data sheet](#).

Table 1- General specifications

	Parameter	Conditions	Minimum	Nominal	Maximum	Unit
Input	Input voltage		4.75	32		Vdc
	Output current				1000	mA
Output	Minimum load			1		%
	Ripple and noise*	20 MHz BW			100	mVp-p
	Output voltage accuracy		-3		+3	%

* Ripple & noise: Measured with 20 MHz bandwidth and 4.7 μF ceramic capacitor.

Test set-up

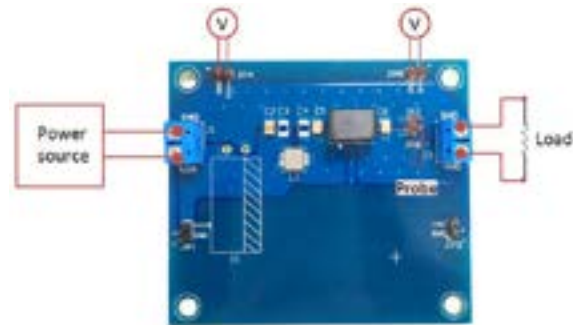

Figure 2: Test set-up example

Table 2- Pin configuration

Connector	Function	Pin symbol	Description
J1	Input terminal	VIN GND	Connect the VIN and GND terminals to the DC power source respectively.
J2	Output terminal	VO GND	Connect the VO and GND terminals to the (electronic) load.
JP1/JP4	Input voltage measuring point	+VIN GND	Connect the +VIN and GND terminals to the voltage meter.
JP2	Output ripple measuring point	+VO GND	Connect the +VO and GND terminals to the probe with short ground lead.
JP3/JP5	Output voltage measuring point	+VO GND	Connect the +VO and GND terminals to the voltage meter.

Operation notes

EMI filter

Figure 3 shows the EMI filter circuit of EVK board. See Table 3 for the component list for each EMI class.

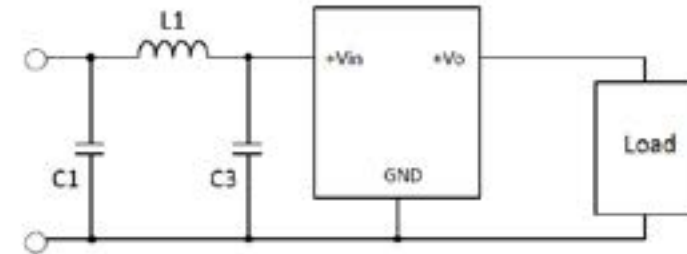

Figure 3: EMI filter circuit diagram

Table 3- EMI class component list

Class	C1	L1	C3
EPM78-EVK Class A	4.7 μF, 1206, 50 V ceramic capacitor	3.3 μH	N/A
EPM78-EVK Class B	10 μF, 1210, 50 V ceramic capacitor	10 μH	4.7 μF, 1206, 50 V ceramic capacitor

Test results

Typical characteristics

Model number: EPM78V2-05R0-01R0R

Efficiency vs load

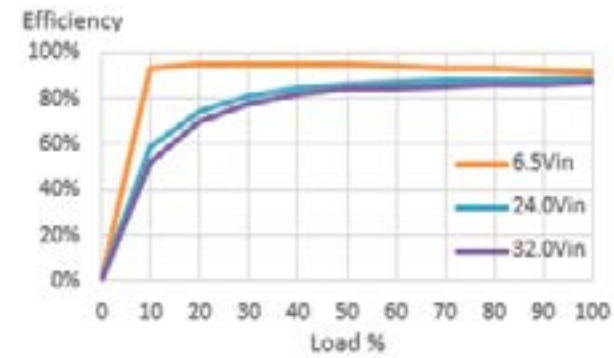

Power dissipation vs load

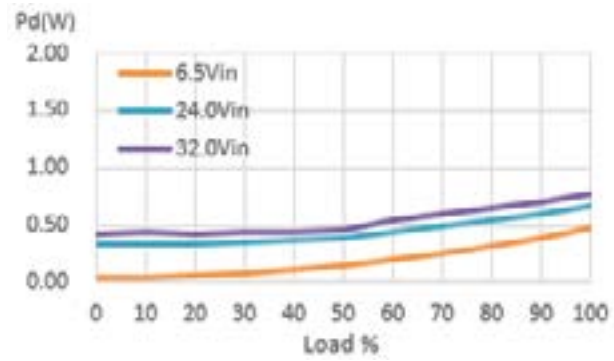

Line regulation vs load

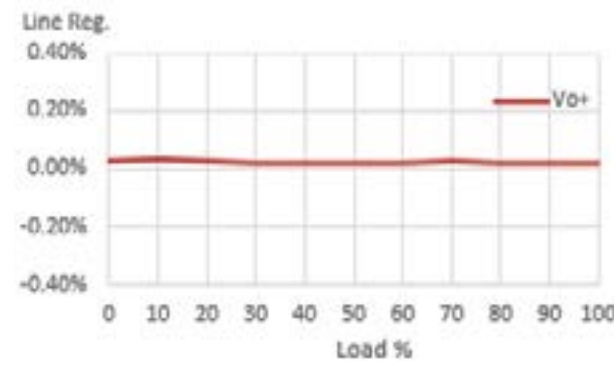

Load regulation vs load

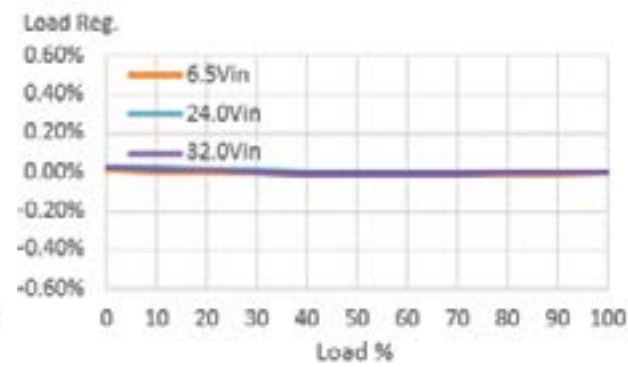

Accuracy vs load

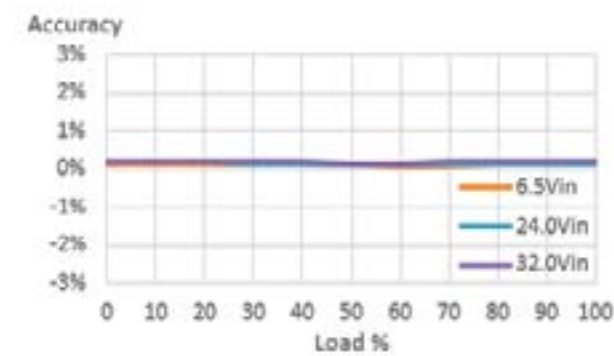

Typical characteristics

Model number: EPM78V2-15R0-01R0R

Efficiency vs load

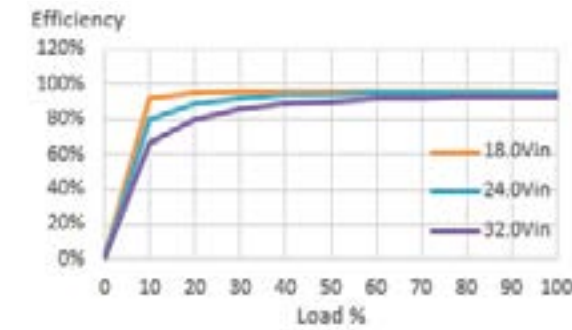

Power dissipation vs load

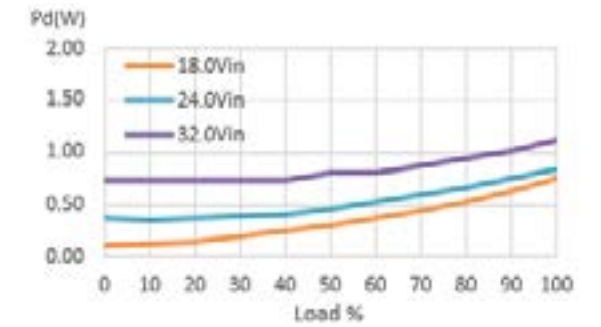

Line regulation vs load

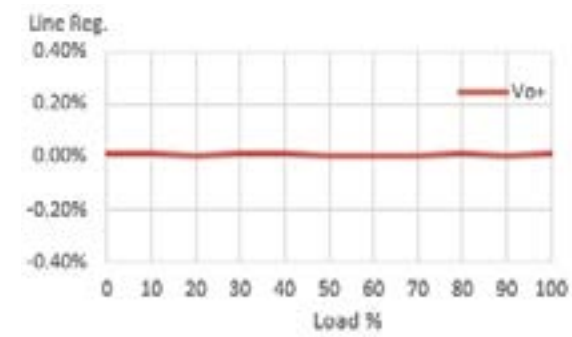

Load regulation vs load

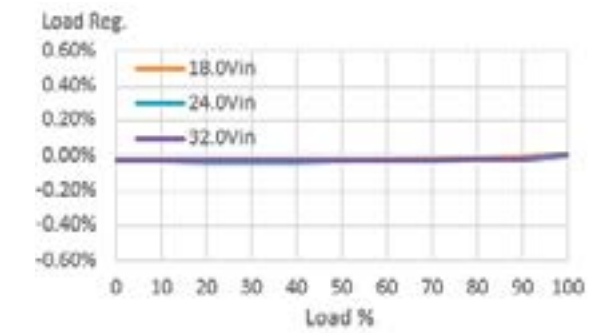

Accuracy vs load

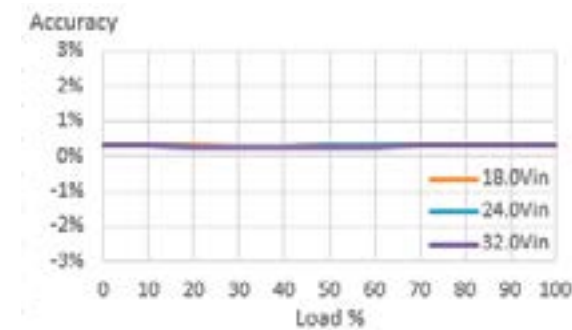

EVK set-up and operation wave form

Model number: EPM78V2-05R0-01R0R
 Conditions: Ta=+25 °C, VIN=24 V, IO=1 A (full load).

Start-up

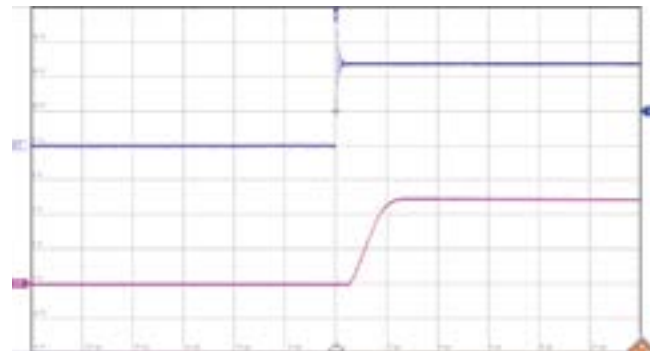

Ch1: Input voltage (10 V/div.) Time scale: (2 ms/div.)
 Ch2: Output voltage (2 V/div.)

Shut-down



Ch1: Input voltage (10 V/div.) Time scale: (2 ms/div.)
 Ch2: Output voltage (2 V/div.)

Output ripple and noise

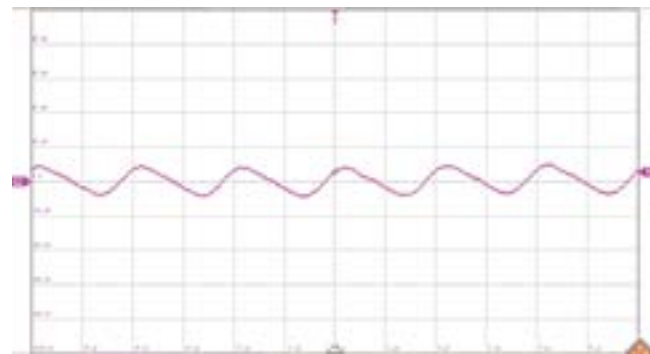

Ch1: Output voltage (20 mV/div) Time scale: (1 us/div.)

Transient response (75%-100% load)

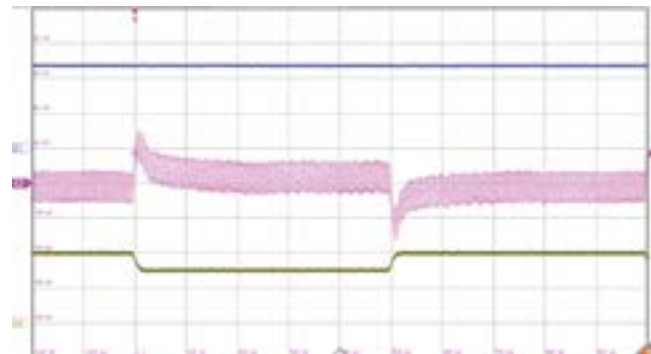

Ch1: Input voltage (10 V/div.) Ch4: Output current (500m A/div)
 Ch2: Output voltage (20 mV/div.) Time scale: (100us/div.)

EVK set-up and operation wave form

Model number: EPM78V2-15R0-01R0R
 Conditions: Ta=+25 °C, VIN=24 V, IO=1 A (full load).

Start-up

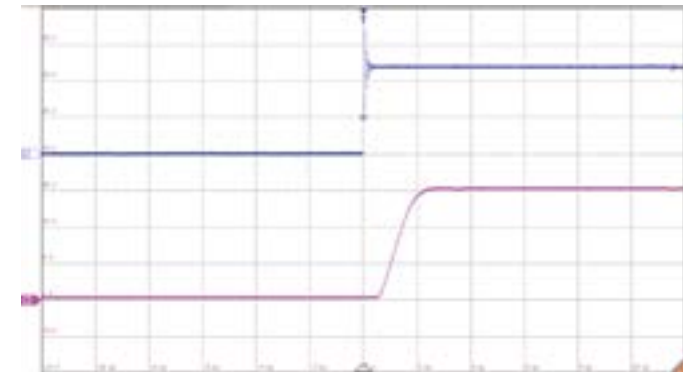

Ch1: Input voltage (10 V/div.) Time scale: (2 ms/div.)
 Ch2: Output voltage (5 V/div.)

Shut-down

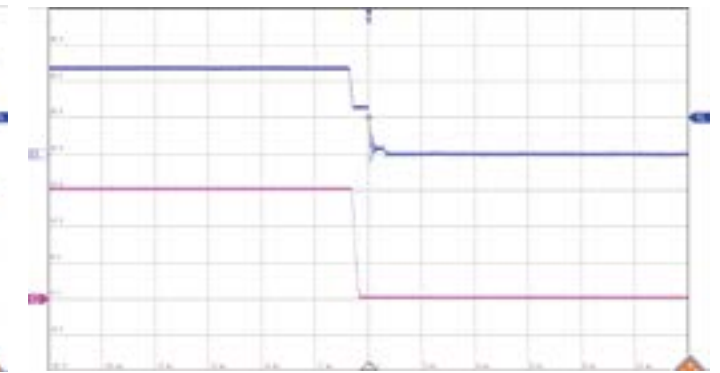

Ch1: Input voltage (10 V/div.) Time scale: (2 ms/div.)
 Ch2: Output voltage (5 V/div.)

Output ripple and noise

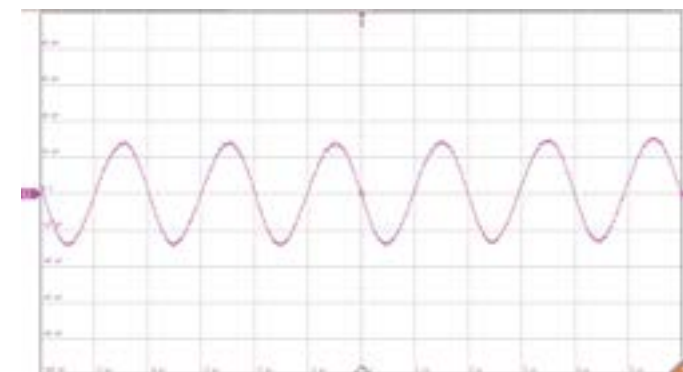

Ch1: Output voltage (20 mV/div.) Time scale: (1 us/div.)

Transient response (75%-100% load)

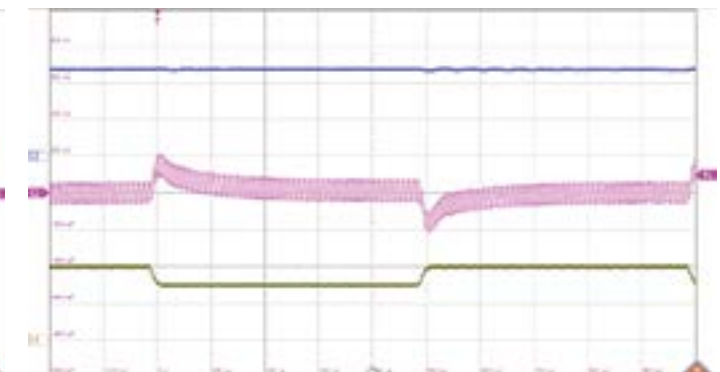

Ch1: Input voltage (10 V/div.) Ch4: Output current (500m A/div)
 Ch2: Output voltage (100 mV/div.) Time scale: (100 us/div.)

EPM78Vx Evaluation kit user guide

Conducted emission measurement

Model number: EPM78V2-05R0-01R0R

Conducted class B of neutral

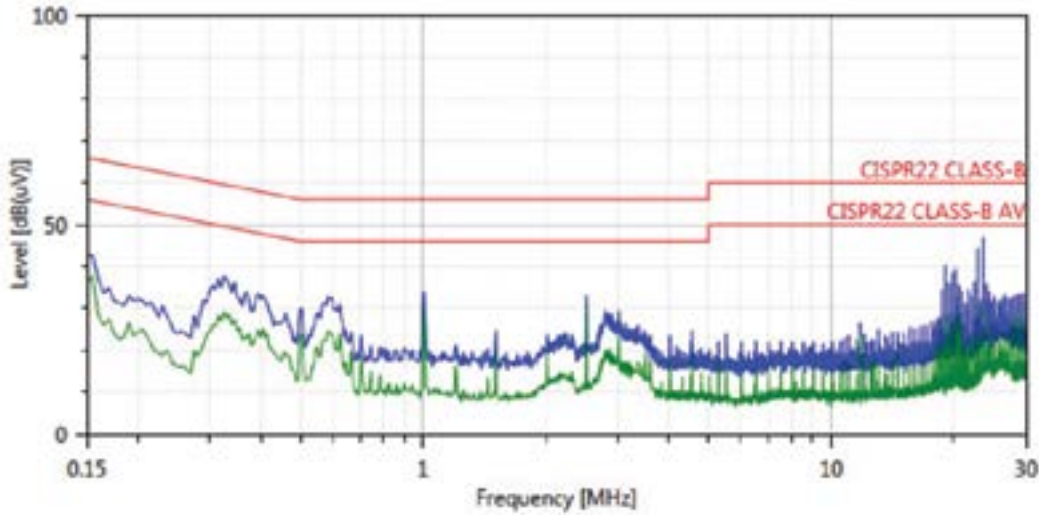

With Class B filter Blue line: Peak
Band: 0.15 - 30 MHz Green line: Average

Conducted class B of line

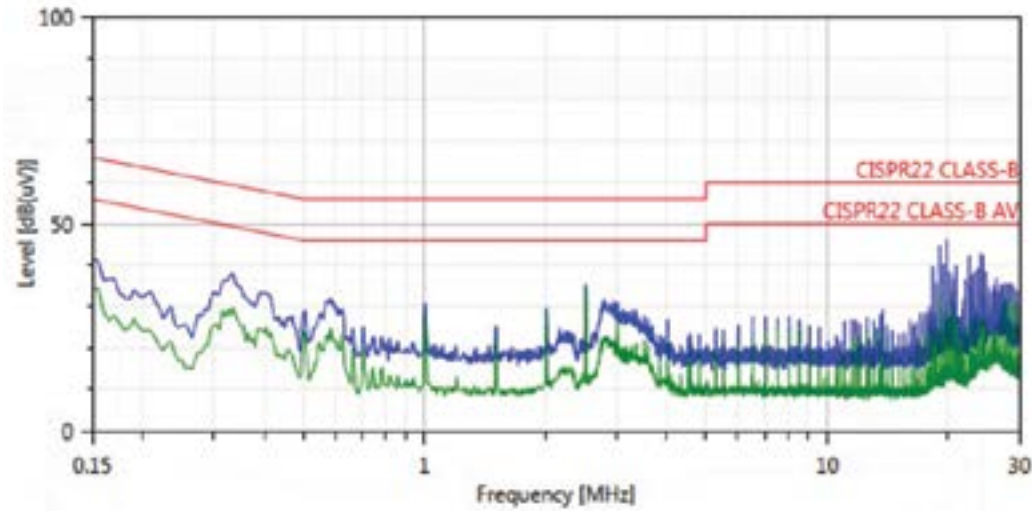

With Class B filter Blue line: Peak
Band: 0.15 - 30 MHz Green line: Average

Schematic

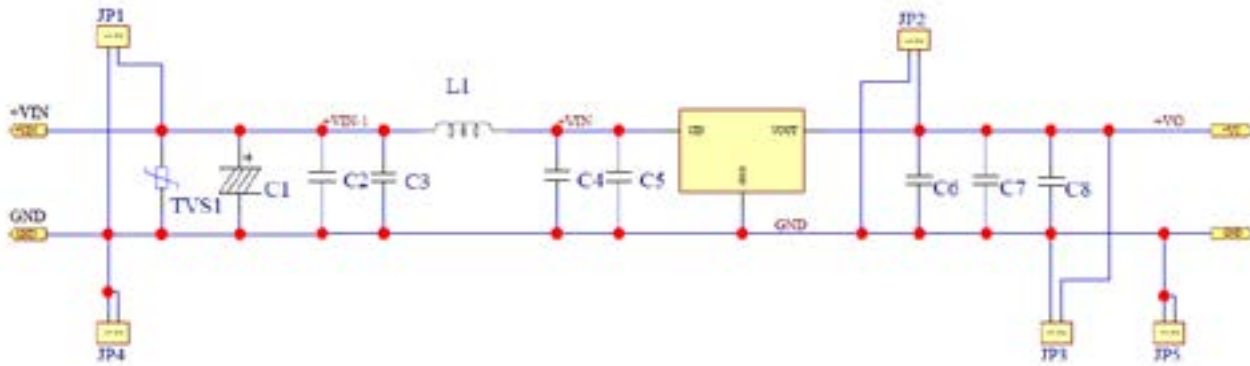

Layout

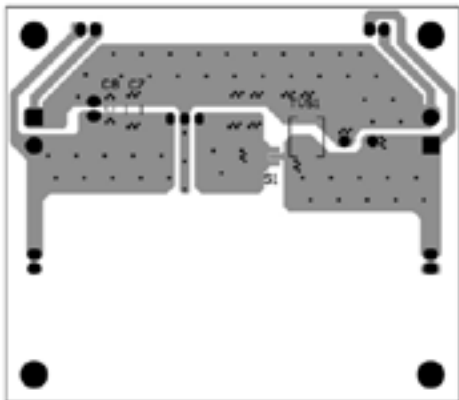
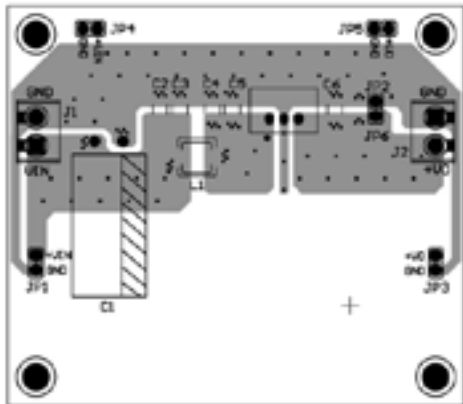

Component list (for EPM78V2-05R0-01R0R)

Description	Qty	Designator
EPM78V2-05R0-01R0R	1	
Capacitor, X7R, 1210, 10UF±10%, 50V	1	C2
Capacitor, X7R, 1210, 4.7UF±10%, 50V	2	C4, C6
Inductor, MPCA-0530-100M	1	L1
Capacitor, 220UF/200V, KXJ series, 12.5x25 mm	1	C1
Terminal Block, 2P, pitch: 5.0mm	2	J1, J2
Pin Header, single row, 14.2mm, 2P	5	JP1, JP2, JP3, JP4, JP5

Eaton
Electronics Division
 1000 Eaton Boulevard
 Cleveland, OH 44122
 United States
 Eaton.com/electronics

© 2021 Eaton
 All Rights Reserved
 Printed in USA
 Publication no. EXL1038 BU-ELX21038
 April 2021

Eaton is a registered trademark.

All trademarks are property of their respective owners.