

CHSA

SMD current sensing resistor-metal shunt



Applications

- Electronic power steering (EPS) modules
- DC/DC converters, including automotive
- Automotive on-board chargers (OBC)
- Brushless DC (BLDC) motor control

Product features

- Ultra low and stable resistance
- 2512 (6432 metric) to 5930 (15076 metric) package
- High power ratings, up to 15 W
- AEC-Q200
- Moisture sensitivity level (MSL): 1

Environmental compliance



Table 1. Part numbering configuration scheme

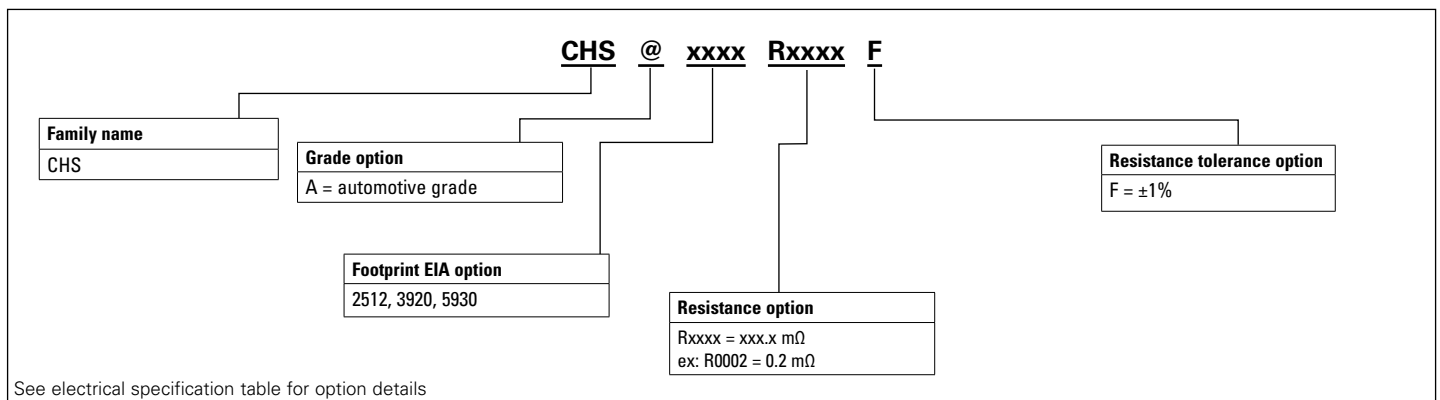

Mechanical parameters- Inches [mm]

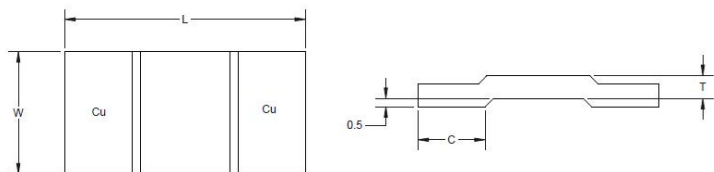

Construction

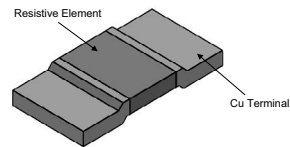

Family	Size code	L	W	C	T
CHSA2512	2512 [6432]	0.248 ± 0.008 [6.30 ± 0.20]	0.122 ± 0.012 [3.10 ± 0.30]	0.047 ± 0.012 [1.20 ± 0.30]	See electrical specifications table for details
CHSA3920	3920 [10052]	0.394 ± 0.012 [10.0 ± 0.30]	0.205 ± 0.016 [5.20 ± 0.40]	0.087 ± 0.008 [2.20 ± 0.20]	
CHSA5930	5930 [15076]	0.591 ± 0.012 [15.0 ± 0.30]	0.299 ± 0.016 [7.60 ± 0.40]	0.165 ± 0.016 [4.20 ± 0.40]	

Recommended PCB layout- mm

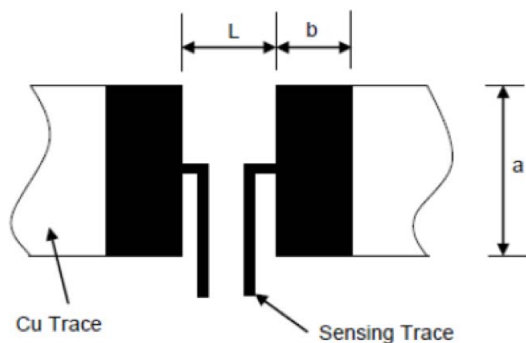

Family	a	b	L
CHSA2512	3.4	1.8	3.4
CHSA3920	6.2	2.7	5.6
CHSA5930	8.75	5.2	5.6

1. The copper foil minimum thickness of PCB needs 3 oz.
2. PCB layout dimension tolerance is +/-0.1 mm.
3. The resistance will change slightly after soldered; it is dependent on PCB pad size design and it's necessary to consider the effect of the resistance increase or decrease.

Part marking

Family	Resistance Value (mΩ)	Marking
CHSA2512	0.2	L20
CHSA2512	0.3	L30
CHSA2512	0.5	L50
CHSA2512	1	1L0
CHSA2512	2	2L0
CHSA2512	3	3L0
CHSA2512	4	4L0
CHSA2512	5	5L0
CHSA3920	0.2	L20
CHSA3920	0.3	L30
CHSA3920	0.5	L50
CHSA3920	1	1L0
CHSA3920	2	2L0
CHSA3920	3	3L0
CHSA3920	4	4L0
CHSA3920	5	5L0

Family	Resistance Value (mΩ)	Marking
CHSA5930	0.1	L10
CHSA5930	0.2	L20
CHSA5930	0.3	L30
CHSA5930	0.5	L50
CHSA5930	0.75	L75
CHSA5930	1	1L0
CHSA5930	2	2L0
CHSA5930	3	3L0

Electrical specifications

Part number	Size	Grade option	Resistance value mΩ (Part number code)	Resistance tolerance (Part number code)	Power (W)	Dimension T (mm) ±0.1 mm	TCR (ppm/°C)	Operating temperature
CHS@2512Rxxxx*	2512 (6432 metric)	A	0.2 (0002)	±1% (F)	6	1.00	±175	-55 °C to +170 °C
CHS@2512Rxxxx*	2512 (6432 metric)	A	0.3 (0003)	±1% (F)	6	1.00	±175	-55 °C to +170 °C
CHS@2512Rxxxx*	2512 (6432 metric)	A	0.5 (0005)	±1% (F)	6	0.84	±115	-55 °C to +170 °C
CHS@2512Rxxxx*	2512 (6432 metric)	A	1 (0010)	±1% (F)	5	0.42	±100	-55 °C to +170 °C
CHS@2512Rxxxx*	2512 (6432 metric)	A	2 (0020)	±1% (F)	5	0.70	±50	-55 °C to +170 °C
CHS@2512Rxxxx*	2512 (6432 metric)	A	3 (0030)	±1% (F)	4	0.47	±50	-55 °C to +170 °C
CHS@2512Rxxxx*	2512 (6432 metric)	A	4 (0040)	±1% (F)	3	0.35	±50	-55 °C to +170 °C
CHS@2512Rxxxx*	2512 (6432 metric)	A	5 (0050)	±1% (F)	3	0.28	±50	-55 °C to +170 °C
CHS@3920Rxxxx*	3920 (10052 metric)	A	0.2 (0002)	±1% (F)	12	1.66	±125	-55 °C to +170 °C
CHS@3920Rxxxx*	3920 (10052 metric)	A	0.3 (0003)	±1% (F)	10	1.42	±150	-55 °C to +170 °C
CHS@3920Rxxxx*	3920 (10052 metric)	A	0.5 (0005)	±1% (F)	9	0.82	±70	-55 °C to +170 °C
CHS@3920Rxxxx*	3920 (10052 metric)	A	1 (0010)	±1% (F)	8	0.41	±50	-55 °C to +170 °C
CHS@3920Rxxxx*	3920 (10052 metric)	A	2 (0020)	±1% (F)	6	0.64	±50	-55 °C to +170 °C
CHS@3920Rxxxx*	3920 (10052 metric)	A	3 (0030)	±1% (F)	5	0.43	±50	-55 °C to +170 °C
CHS@3920Rxxxx*	3920 (10052 metric)	A	4 (0040)	±1% (F)	5	0.32	±50	-55 °C to +170 °C
CHS@3920Rxxxx*	3920 (10052 metric)	A	5 (0050)	±1% (F)	5	0.26	±50	-55 °C to +170 °C
CHS@5930Rxxxx*	5930 (15076 metric)	A	0.1 (0001)	±1% (F)	15	1.90	±200	-55 °C to +170 °C
CHS@5930Rxxxx*	5930 (15076 metric)	A	0.2 (0002)	±1% (F)	15	1.42	±100	-55 °C to +170 °C
CHS@5930Rxxxx*	5930 (15076 metric)	A	0.3 (0003)	±1% (F)	10	0.98	±75	-55 °C to +170 °C
CHS@5930Rxxxx*	5930 (15076 metric)	A	0.5 (0005)	±1% (F)	10	0.56	±75	-55 °C to +170 °C
CHS@5930Rxxxx*	5930 (15076 metric)	A	0.75 (0008)	±1% (F)	10	0.41	±75	-55 °C to +170 °C
CHS@5930Rxxxx*	5930 (15076 metric)	A	1 (0010)	±1% (F)	9	0.90	±50	-55 °C to +170 °C
CHS@5930Rxxxx*	5930 (15076 metric)	A	2 (0020)	±1% (F)	7	0.48	±50	-55 °C to +170 °C
CHS@5930Rxxxx*	5930 (15076 metric)	A	3 (0030)	±1% (F)	7	0.32	±50	-55 °C to +170 °C

@= Enter grade option from table above (A=Automotive)

Rxxxx = Enter resistance code option from table above xxxx= resistance code (xxx.x mΩ ex: R0002 = 0.2 mΩ, R0008 = 0.75 mΩ)

*= Enter resistance tolerance code option from table above (F= ±1%)

Packaging information- mm

Supplied in tape and reel on a 13" diameter reel (EIA-481 compliant)

Size	Tape	Quantity
2512	13 inch (330 mm) embossed	4K
3920	13 inch (330 mm) embossed	3K
5930	13 inch (330 mm) embossed	1.5K

Tape carrier and dimensions

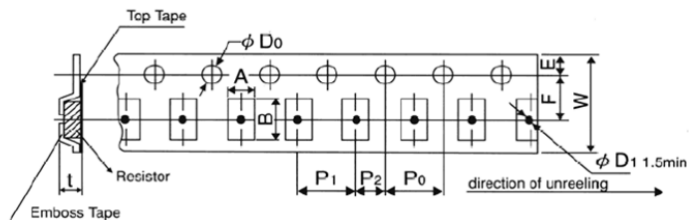

Dimension	2512	3920	5930
E	1.75 ± 0.1	1.75 ± 0.1	1.75 ± 0.1
F	5.5 ± 0.05	7.5 ± 0.05	11.5 ± 0.05
P2	2.0 ± 0.1	2.0 ± 0.1	2.0 ± 0.1
D0	1.50 ± 0.1	1.50 ± 0.1	1.50 ± 0.1
P0	4.0 ± 0.1	4.0 ± 0.1	4.0 ± 0.1
W	12.0 ± 0.1	16.0 ± 0.1	24.0 ± 0.1
P1	8.0 ± 0.1	8.0 ± 0.1	12.0 ± 0.1
A	3.6 ± 0.2	5.7 ± 0.2	8.3 ± 0.2
B	6.7 ± 0.2	10.5 ± 0.2	15.6 ± 0.2
t	1.7 ± 0.15	2.25 ± 0.15	2.4 ± 0.15

Reel dimensions

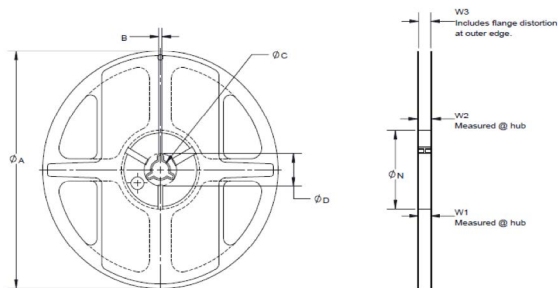

Family	A	B	C	D	N	W1	W2	W3
CHSA2512	330 ± 2.0	5.0 ± 0.5	13.0 ± 1.0	15.0 ± 1.0	100 ± 1.0	12.0 ± 1.0	16.0 ± 1.0	na
CHSA3920	330 ± 2.0	5.0 ± 0.5	13.0 ± 1.0	15.0 ± 1.0	100 ± 1.0	16.0 ± 1.0	20.0 ± 1.0	na
CHSA5930	330 ± 2.0	5.0 ± 0.5	13.0 ± 1.0	15.0 ± 1.0	100 ± 1.0	24.0 ± 1.0	28.0 ± 1.0	na

General specifications

Temperature coefficient of resistance: IEC60115-1 4.8, +25 to +125 °C

Short time overload: IEC60115-1 4.13, 5 X rated power for 5 s

High temperature exposure (storage): AEC-Q200-REV D-Test 3, MIL-STD202 Method 108, 1000 hours, +170 °C

Temperature cycling: AEC-Q200-REV D-Test 4, JESD22 Method JA-104, 1000 Cycles (-55 °C to +125 °C)

Moisture resistance: AEC-Q200-REV D-Test 6, MIL-STD-202 Method 106, T=24 hours / Cycle, 10 Cycles, Notes: Steps 7a& 7b not required. Unpowered

Biased humidity: AEC-Q200-REV D-Test 7, MIL-STD-202 Method 103, 1000 hours +85 °C/85% RH. Note: Specified conditions: 10% of operating power (not exceeding max working voltage).

Operational life: AEC-Q200-REV D-Test 8, MIL-STD-202 Method 108, 1000 hours, +125 °C at rated derating power

Resistance to solvents: AEC-Q200-REV D-Test 12, MIL-STD-202 Method 215, a: Isopropyl Alcohol : Mineral Spirits= 1 : 3, b: Terpene Defluxer (Bioact EC-7R) c: Deionized water : Propylene Glycol Monomethyl Ether : monoethanolamine = 42 : 1 : 1

Mechanical shock: AEC-Q200-REV D-Test 13, MIL-STD-202 Method 213, Wave Form Peak value is 100 g's. 6 ms

Vibration: AEC-Q200-REV D-Test 14, MIL-STD-202 Method 204, 5 g's for 20 min., 12 cycles each of 3 orientations, Test from 10-2000 Hz

Resistance to soldering heat: AEC-Q200-REV D-Test 15, MIL-STD-202 Method 210, Condition B : Immerse the specimens in and eutectic solder at +260 ± 5 °C for 10 ± 1 s

Thermal shock: AEC-Q200-REV D-Test 16, MIL-STD-202 Method 107, -55 °C/+155 °C. Note: Number of cycles required 300, Maximum transfer time 20 seconds, Dwell time 15 minutes. Air-Air.

ESD: AEC-Q200-REV D-Test 17, AEC-Q200-002 or ISO/DIS 10605, verify the voltage setting at 500 V

Solderability: AEC-Q200-REV D-Test 18, J-STD-002, Method B, aging 4 hours at 155 °C dry heat Lead-free solder bath at 235 ± 3 °C, Dipping time: 3 ± 0.5 seconds, > 95% area covered with tin

Flammability: AEC-Q200-REV D-Test 20, UL-94, V-0 or V-1 are acceptable. Without plastic part. Use final goods burn with methane twice, each 10 s

Board flex (bending): AEC-Q200-REV D-Test 21, AEC-Q200-005, The duration of the applied forces shall be 60 (+ 5) Sec, 2 mm deflection

Terminal strength (SMD): AEC-Q200-REV D-Test 22, AEC-Q200-006, Force of 1.8 kg for 60 seconds

Temperature derating curve

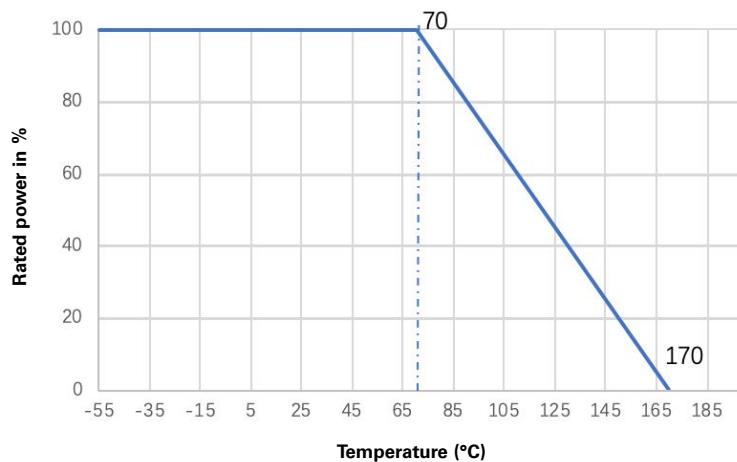

Rated current & voltage

The rated Current and Voltage are calculated by the following formula:

$$I = \sqrt{P \div R}$$

I: Rated current (A)

P: Rated power (W)

$$V = \sqrt{P \times R}$$

V: Rated voltage (V)

R: Resistance value (Ω)

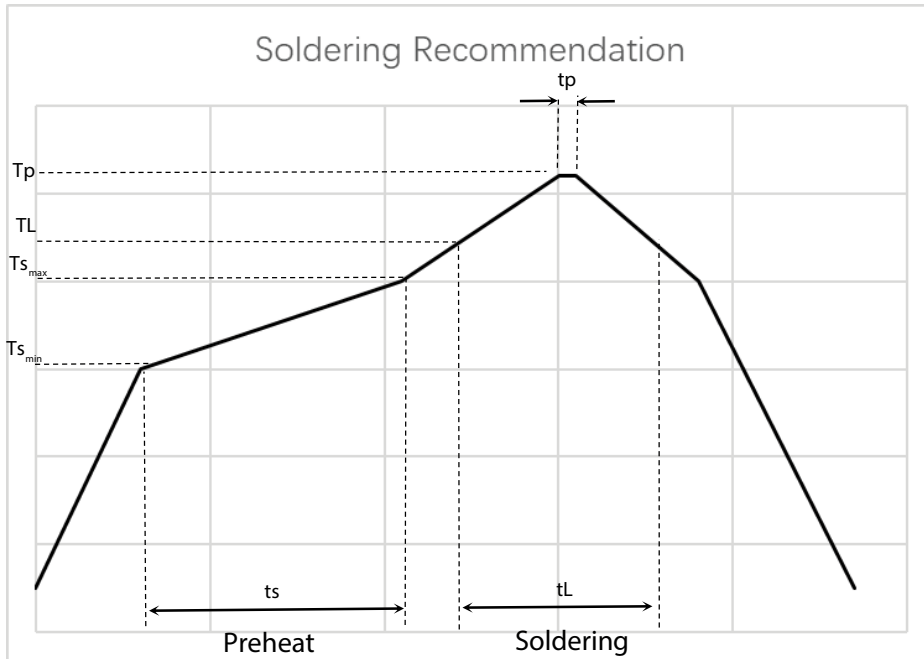

Profile feature	Lead (Pb) free solder
Preheat and soak	<ul style="list-style-type: none"> • Temperature min. (T_{smin}) 150 °C • Temperature max. (T_{smax}) 200 °C • Time (T_{smin} to T_{smax}) (t_s) 60-150 seconds
Average ramp-up rate (T_{smax} to T_p)	3 °C/ second max.
Liquidous temperature (T_L)	217 °C
Time (t_L) maintained above T_L	60-120 seconds
Peak package body temperature (T_p)*	260 °C
Time (t_p) within +5 °C/- 0 °C	10 seconds
Ramp-down rate (T_p to T_L)	6 °C/ second max.
Time 25 °C to peak temperature	8 minutes max.

Manual solder

+350 °C ±10 °C , 3 +1/-0 seconds 1 time (by soldering iron), generally manual, hand soldering is not recommended

Life Support Policy: Eaton does not authorize the use of any of its products for use in life support devices or systems without the express written approval of an officer of the Company. Life support systems are devices which support or sustain life, and whose failure to perform, when properly used in accordance with instructions for use provided in the labeling, can be reasonably expected to result in significant injury to the user.

Eaton reserves the right, without notice, to change design or construction of any products and to discontinue or limit distribution of any products. Eaton also reserves the right to change or update, without notice, any technical information contained in this bulletin.

Eaton
Electronics Division
1000 Eaton Boulevard
Cleveland, OH 44122
United States
Eaton.com/electronics

© 2023 Eaton
All Rights Reserved
Printed in USA
Publication No. ELX1223
July 2023

Eaton is a registered trademark.

All other trademarks are property of their respective owners.

Follow us on social media to get the latest product and support information.

